

High-Bandwidth Servo-Drive Performance in a Quantitative Comparison of Control Systems

Executive summary

The goal of a good motion control system is to take full advantage of the system bandwidth and to reject disturbances. High bandwidth allows the system to reject disturbances more quickly. This paper presents a detailed quantitative comparison of two servo-drive and motor combinations (one with a higher-bandwidth servo-drive than the other) in linear spindle axis and linear belt axis schema, as well as when two motors are coupled directly. The results conclude that the working rate for the high-bandwidth servo-drive is not limited by motor speed for “long” distances.

Introduction

Any linear system can be viewed as a filter, and in most real cases a low-pass filter.

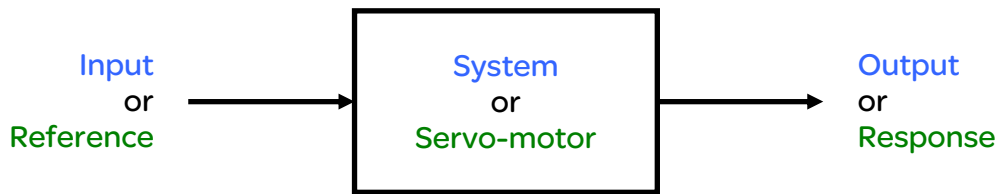

Figure 1: General definition of a system and of a servo-motor as a system

This means that all frequencies are not present in the system response. For a first-order low-pass system, if the input consists of a very wide range of frequencies, the output is composed of only low frequencies. The high frequencies will be attenuated and almost absent. The limit is called the cutoff frequency. Thus, the bandwidth of a system determines the richness of its frequency response.

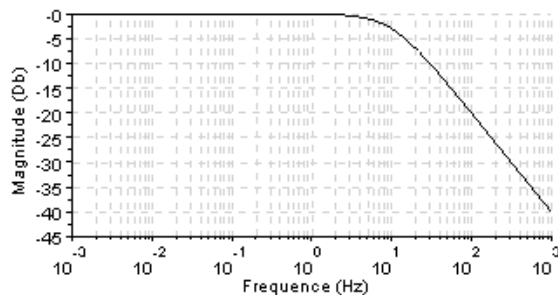

Figure 2: Bode diagram for a first-order low-pass filter

In the figure 2, the system responds to frequencies up to 10 [Hz]. This will influence the behavior of the system after a reference change or if a disturbance occurs.

If the objective is to reach high working rates, the axis movement must never stop. Any pause in the movement is therefore an unproductive period of time. We study in this article, trajectory tracking with a triangular position profile. The charge executes some back and forth movement as quickly as possible.

The triangular trajectory has a range of frequencies in its spectrum. If the system is able to respond to all of these frequencies, the system perfectly follows the reference. The more the working rate increases, the higher are the frequencies. So if the fundamental frequency of the triangular signal exceeds the system bandwidth, it will not follow any more the reference.

Control issues

Trajectory tracking

When the reference to follow is not constant it is called trajectory. For the trajectory tracking, high bandwidth limits the tracking error.

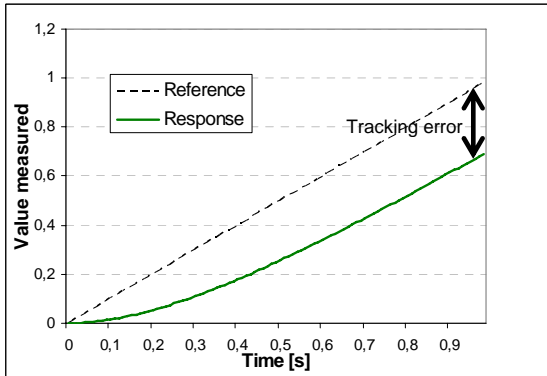

Figure 3: Ramp response of a first-order filter

This is expressed by a delay between the desired position and the measured position. A second problem occurs at the uttermost points of the trajectory which are sometimes not met due to an insufficient bandwidth.

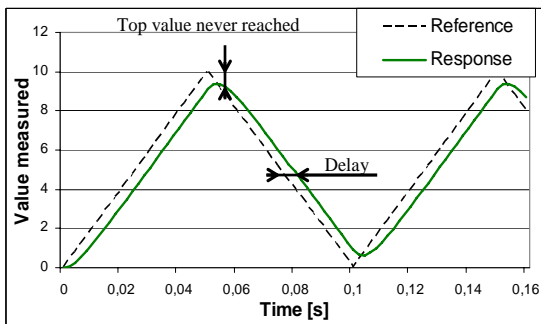

Figure 4: Saw tooth response of a first-order filter

A system with a high bandwidth allows to minimize the delay and to reach the uttermost positions of the trajectories.

Disturbance rejection

When the system undergoes an external perturbation, the position must return to the reference as soon as possible. The disturbance rejection is one of the most important points of control systems. A high bandwidth allows fast disturbance rejection.

In the figure below, a step disturbance is applied on two different controlled systems.

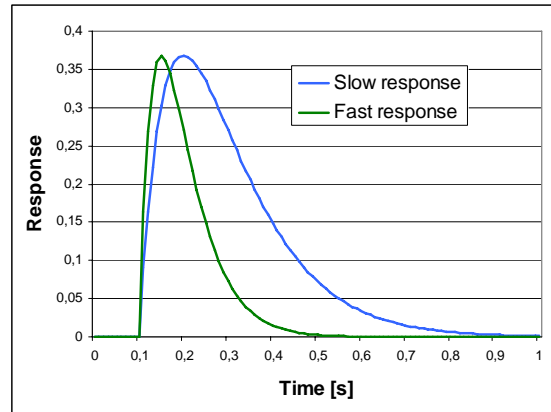

Figure 5: Step disturbance rejection for two different controlled systems

On the figure 5, the only difference between the two systems is the bandwidth. Many kind of disturbance are possible: a mass change of the system can be considered a disturbance (e.g. a “pick and place” application), the wind on a swiveling solar panel is also an example of disruption.

During a trajectory tracking, a disturbance moves the response away from the reference. To reach high working rates it is therefore important that disturbances are rejected as soon as possible to allow the system to reach the reference.

Control loops of the Lexium 32

The goal of a good control system is to fully take advantage of the system bandwidth and to reject the disturbances. The problem when a system is excited with high frequencies, is that resonance phenomena may occur. Indeed, mechanical systems are not infinitely stiff and have resonant frequencies depending on the shape and the nature of material. The presence of dead zones in the transmission system can also induce resonance frequencies.

The control loops of the Lexium 32 have notch filters to reduce the resonance frequencies problems. This allows to surpass this limit and to reach higher frequencies.

Mechanical systems to the test

Linear axes

Mechanical description of the spindle axis

The linear spindle axis figure 6 consists of a motor directly coupled to a screw without gearbox. The screw moves a carriage, without additional load. The control is performed by the motor encoder and the actual linear position is measured by the machine encoder.

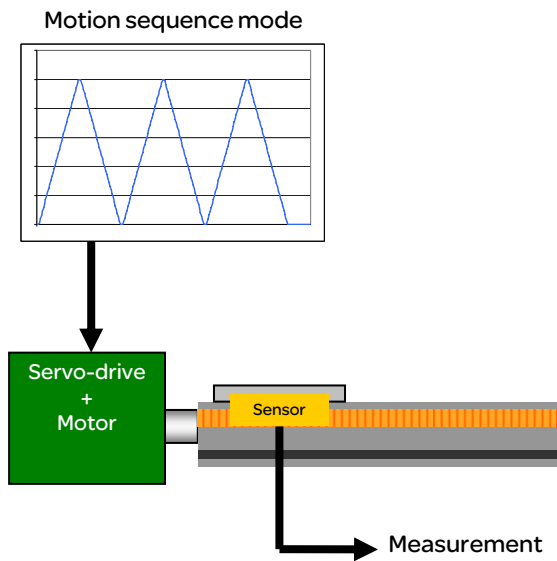

Figure 6: Linear spindle axis schema

The servo-drive is a Lexium32 (LXM32MD30N4) and the motor is a BSH0703M. This couple from Schneider Electric is compared with a competitor couple {servo-drive + motor}. The two motors have the same nominal torque of 2.4 [Nm].

Mechanical description of the belt axis

The linear belt axis figure 7 consists of a motor directly coupled to a belt without gearbox. The belt moves a carriage, without additional load. The control is performed by the motor encoder and the actual linear position is measured by the machine encoder.

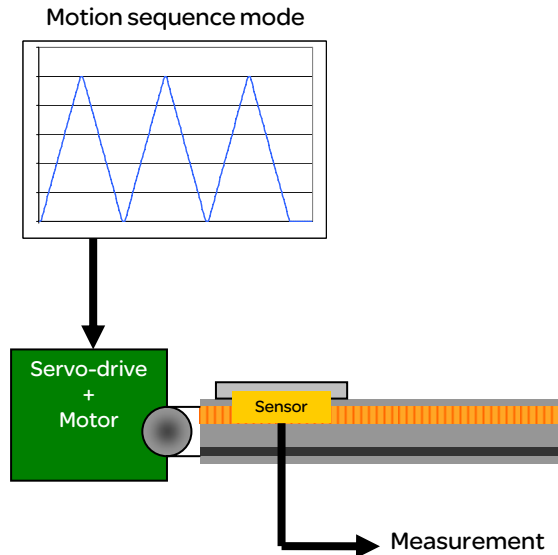

Figure 7: Linear belt axis schema

The servo-drive is a Lexium32 (LXM32MD30N4) and the motor is a BSH0703M. This couple from Schneider Electric is compared with a competitor couple {servo-drive + motor}. The two motors have the same nominal torque of 2.4 [Nm].

Test sequence description

The trajectory which must be followed by the carriage is a series of back and forth movement on a saw tooth profile. The distance between the two positions is 10 [mm]. The speed between these two points varies between 26 [mm/s] and 1067 [mm/s], which corresponds to a working rate of 80 [strokes/min] to 2350 [strokes/min]. The acceleration/deceleration ramps are limited at 106 [RPM/s].

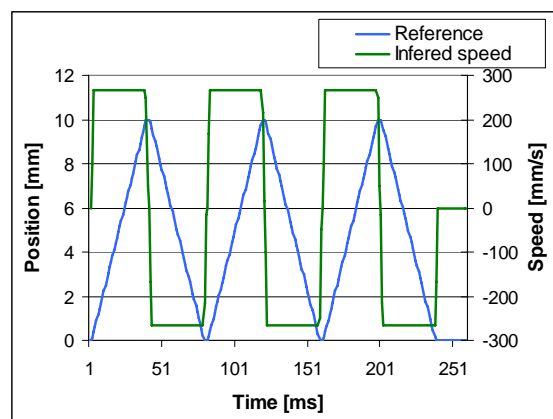

Figure 8: Trajectory for a working rate of 755 [strokes/min]

The left scale represents the reference position of the carriage in [mm], while the right scale represents the linear speed in [mm/s]. The goal is to closely follow the reference in order to minimize the tracking error.

Mechanical systems to the test

Direct coupling

Mechanical description

Two motors are directly coupled together by their rotor shaft. The two stators are also attached to each other via the frame so that they can not move. The motor A is a BSH0703M, and the motor B is a BSH1002P.

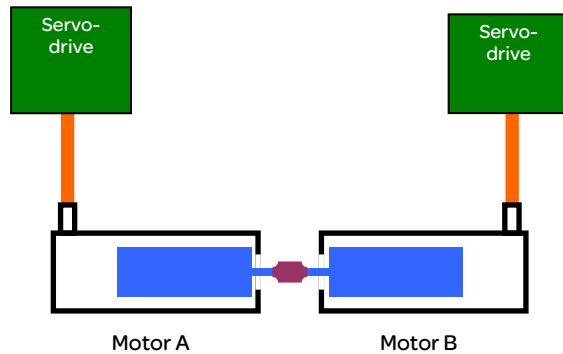

Figure 9: Direct coupling between two motors

Test sequence description

The motor A receives a constant position reference. Then, at a predetermined time, the motor B receives a constant torque reference of 0.87 [Nm]. This torque is seen by the motor A as a disturbance which must be rejected.

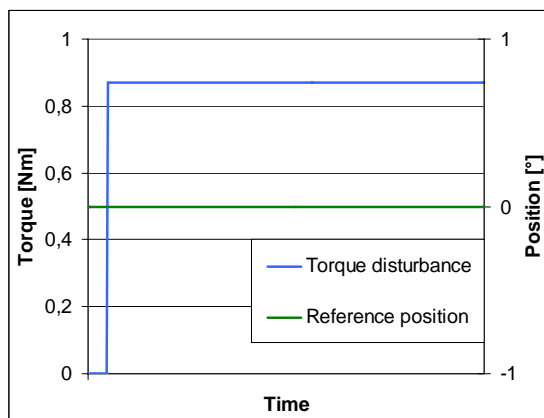

Figure 10: Torque disturbance applied by the motor B on the motor A

The right scale represents the reference position of the motor A in [°], while the left scale represents the torque which is applied by the motor B in [Nm]. The final objective is to measure the position deflection of the motor A and to determine the time it takes to return to the original position.

Measurement analysis

Trajectory tracking

Spindle Axis

On the linear spindle axis, the motion sequence is executed and the position of the carriage is measured for different working rates.

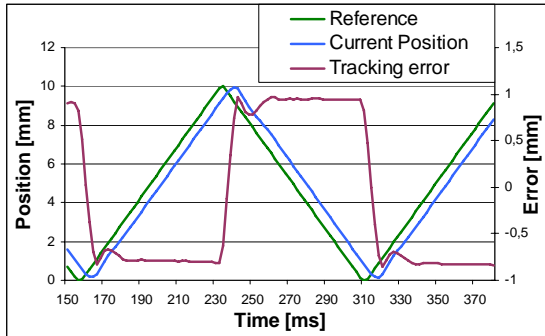

Figure 11: Trajectory tracking for a saw tooth profile (motor BSH0703M, working rate of 390 [strokes/min])

By increasing the working rate, the carriage is no longer able to follow the reference. This is due to the limited bandwidth: the fundamental frequency of the reference is beyond the cutoff frequency of the system.

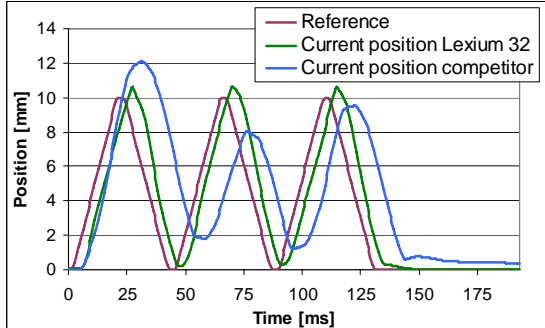

Figure 12: Trajectory tracking for a saw tooth profile (working rate of 1370 [strokes/min])

The saw tooth response of the competitor is unusable for any application. The response of the Lexium 32 is overshooting at the uttermost positions. This excess magnitude may be critical for some applications.

These problems are due to a mechanical issue in the transmission system. The balls which are the link between the carriage and the screw are slightly smaller than the throat of the screw. There is a play in translation. This kind of dead zone is an important issue in control systems. As the measurement feedback of the control is done on the motor, the dead zone is not compensated by the controller. To estimate the quality of the tracking, the standard deviation of the tracking error is calculated and plotted versus the working rate.

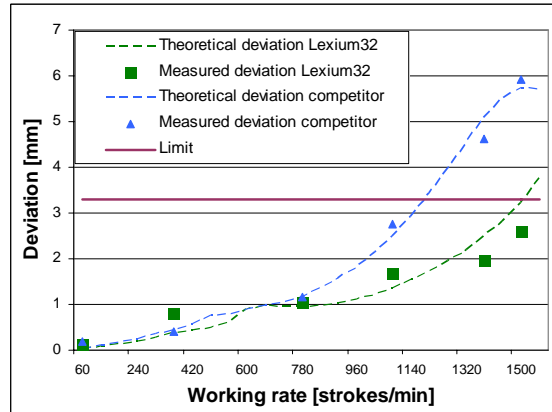

Figure 13: Deviation versus the working rate for the spindle axis

The limit is defined by the standard deviation of the reference. Beyond this limit, the system does not follow the reference any more, and is sometimes in anti-phase.

The Lexium 32 coupled to the motor BSH0703M follows the reference until a working rate of 1370 [strokes/min], while the competitor is already beyond the limit. At 1990 [strokes/min], both systems are unusable: Lexium 32 is in anti-phase and the competitor almost does not move. The latter does an averaging operation of the reference. The limit working rate difference between the two products is 300 [strokes/min].

Belt Axis

On the linear belt axis, the motion sequence is executed and the position of the carriage is measured for different working rates.

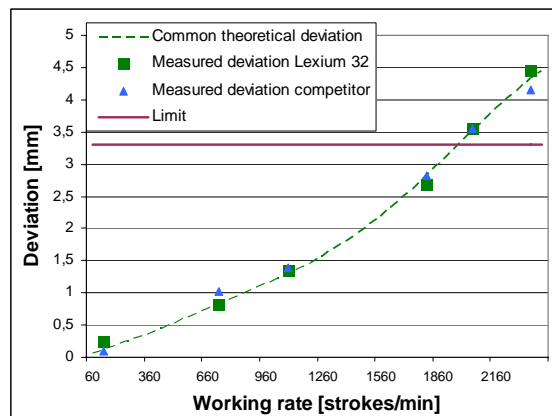

Figure 14: Deviation versus the working rate for the belt axis

Both products are very close for this test. The limit is exceeded around 1900 [strokes/min]. As the spindle axis, the response is very good up to 1200 [strokes/min]. This equality of the products shows that they are optimally adjusted and that only the mechanical parts limit the performance.

Measurement analysis

Disturbance rejection

For the system with two motors directly coupled, the disturbance torque is applied and the position deviation is measured.

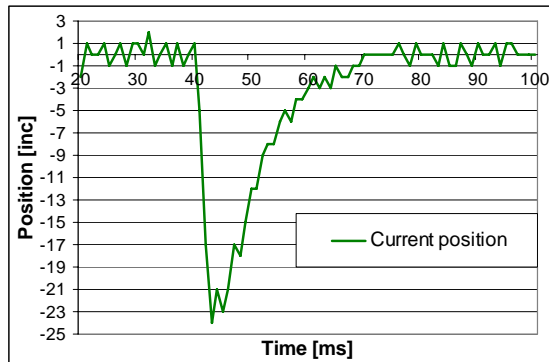

Figure 15: Torque disturbance rejection

If the system is considered as a first-order filter, the time constant is about 8 [ms]. It takes 25 [ms] to reject the disturbance to 95% of its magnitude.

Against a disturbance which represents 36% of motor rated torque, the position only moved of 24 increments. This corresponds to a rotation of 4 [°], or a translation 3 [μm] on the linear spindle axis.

Conclusion

For the systems under the tests, it is possible to reach a working rate of more than 1200 [strokes/min] for a movement of 10 [mm] without any problems. The distance between the two positions can be increased while keeping the same working rate. It simply needs to increase the speed of displacement in parallel with the distance. The problem is that for "long" distances, the working rate will be limited by the maximum speed of the motor.

The trajectory tracking for high working rates depends of course on the mass of the load, the elasticity of the coupling and the presence or absence of dead zones. Despite this, the Lexium 32 allows to fully utilize the driven mechanism. Thus, the performance of a system will never be limited by its controller.