

PowerLogic™ Sub Meter Display (SMD and SMDOPN)

CONTENTS

Introduction	2
Parts of the Sub Meter Display	3
Dimensional Drawing	4
Installation.....	5
Mounting the SMD.....	5
Mounting the SMDOPN.....	6
Communications.....	8
Downstream Devices.....	9
Upstream Devices	9
Terminating the Last Device in the Downstream Daisy Chain.....	10
Power Connection.....	11
Setup	12
Entering the Password	12
Initializing a System.....	12
Viewing the Setup Mode Submenus	12
Monitoring Mode.....	15
Viewing and Resetting Alarms	15
Troubleshooting and Maintenance	16
Changing the Battery.....	16
Changing the Fuse	16
Quick Reference Menu Tree	17
Specifications.....	18
Mounting Template.....	19

INTRODUCTION

The PowerLogic™ Sub Meter Display (SMD and SMDOPN) is a comprehensive electrical sub metering display (Figure 1). With the display, you can view electrical parameters with one networked LCD. In addition to viewing system data on the display itself, you can also view data on a remote PC via a network connection. Touch pad buttons provide a convenient way to view downstream devices on the power monitoring network. The display is RS-485 Modbus RTU compatible. It has additional RS-485 and RS-232 Modbus ports for networking to additional displays or to a master PC.

Figure 1 The Sub Meter Display

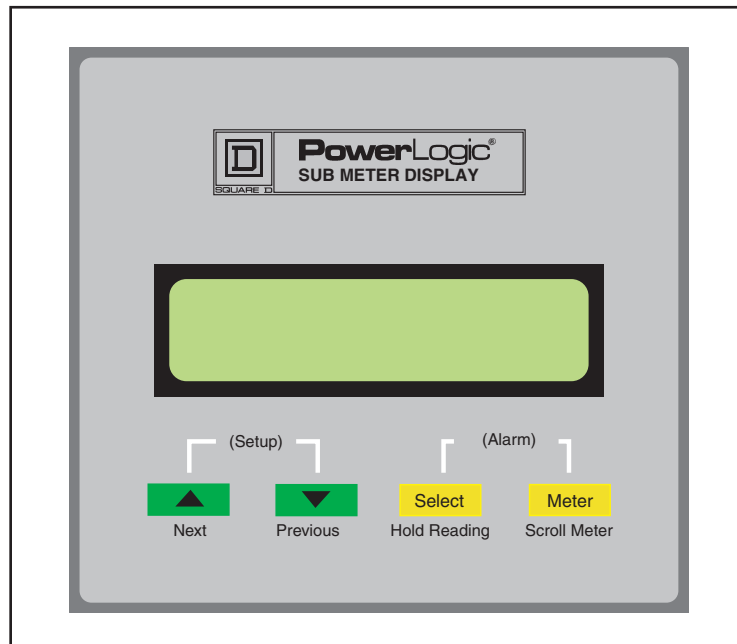

The display provides local indication of all power system parameters from the compatible meters connected downstream. All system parameters and alarms can transmit to the network operations center by means of Modbus RTU protocol. The display supports the following multiple sensors:

- ENERCEPT® Meters
- Branch Circuit Monitors (BCM42 and BCMSC)
- Multi-Circuit Meters (MCM8364)
- Alta Labs Network Temperatures and Humidity Sensors (HXO-485, TXO-485, and HXO/T-485)

Parts of the Sub Meter Display

Figure 2 shows the parts of the display, while Table 1 describes these parts.

Figure 2 Parts of the Display

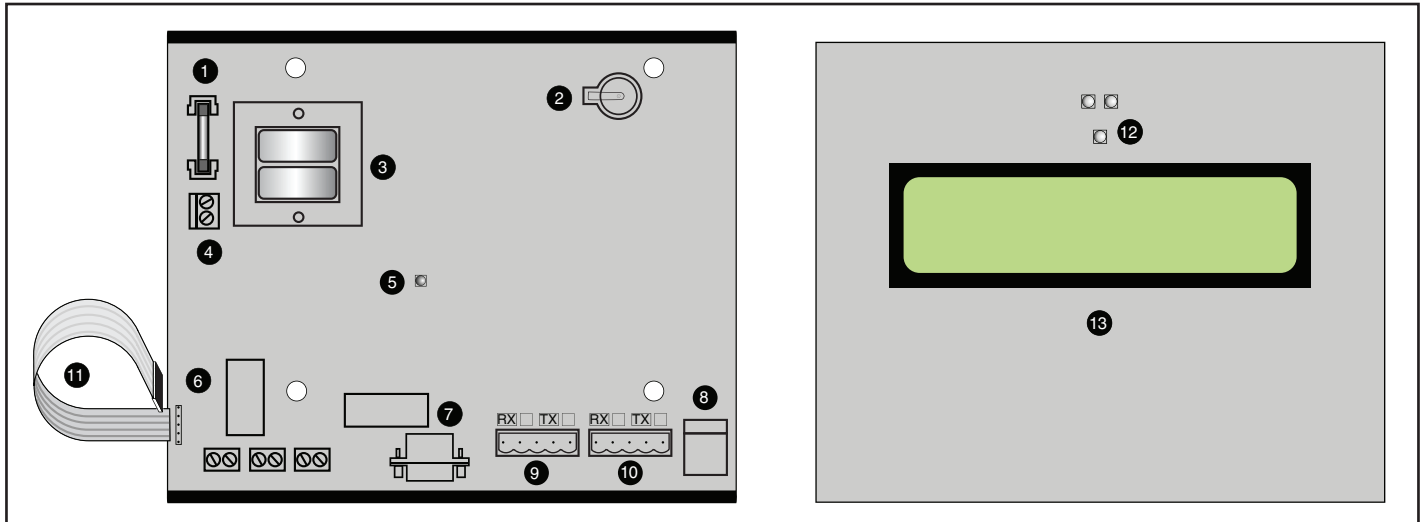
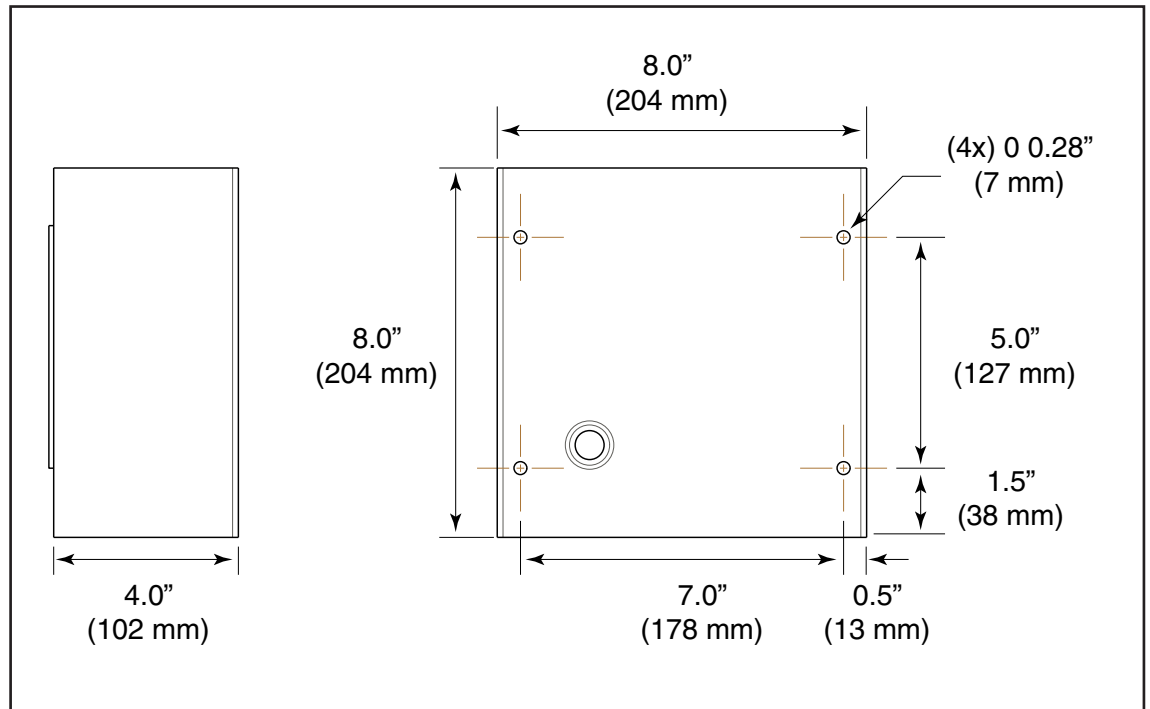

Table 1 Parts Description of the Display

Part		Description
1	250 Vac 200 mA fast fuse	Fused power connection for circuit protection.
2	Lithium battery	Onboard clock backup.
3	Power transformer	Linear power supply for reliability and low noise.
4	120 Vac power supply terminals	2-wire, 120 Vac, 60 Hz, line to neutral.
5	Auxiliary input status LED	Indicates alarm condition for the auxiliary input.
6	Membrane switch pin connector	Connection point for push button panel.
7	Upstream RS-232 input jack	Connection point for upstream RS-232 network.
8	12 Vdc power port	Alternate 12 Vdc connection point for use with plug-in wall-mount transformer or power supply. (Auxiliary input is disabled if 12 Vdc power is used.)
9	Upstream RS-485 connection point	Terminal for upstream RS-485 network. 2- or 4-wire compatible.
10	Downstream RS-485 connection point	Terminal for downstream RS-485 network. 2- or 4-wire compatible.
11	Membrane switch ribbon cable	(From customer-supplied face plate)
12	Status LED	Green = Normal Operation. No network devices are in warning or critical alarm mode. Yellow = One or more network devices are in warning alarm mode. Red = One or more network devices are in critical alarm mode or the auxiliary input is active.
13	Liquid crystal display	High-resolution LCD with adjustable backlight.

Dimensional Drawing



INSTALLATION

⚠ DANGER

HAZARD OF ELECTRIC SHOCK, EXPLOSION, OR ARC FLASH

- Apply appropriate personal protective equipment (PPE) and follow safe electrical work practices. See NFPA 70E.
- This equipment must be installed and serviced only by qualified personnel.
- Turn off all power supplying this equipment and the equipment it is to be mounted inside before working on or inside equipment.
- Always use a properly rated voltage sensing device to confirm that power is off.
- Replace all device doors and covers before turning on power to this equipment.

Failure to observe these instructions will result in death or serious injury.

Mounting the SMD

The SMD ships pre-assembled in a UL508 listed equipment enclosure. The enclosure is equipped with knockouts for power and communication conduit attachments and requires no field assembly except for enclosure mounting.

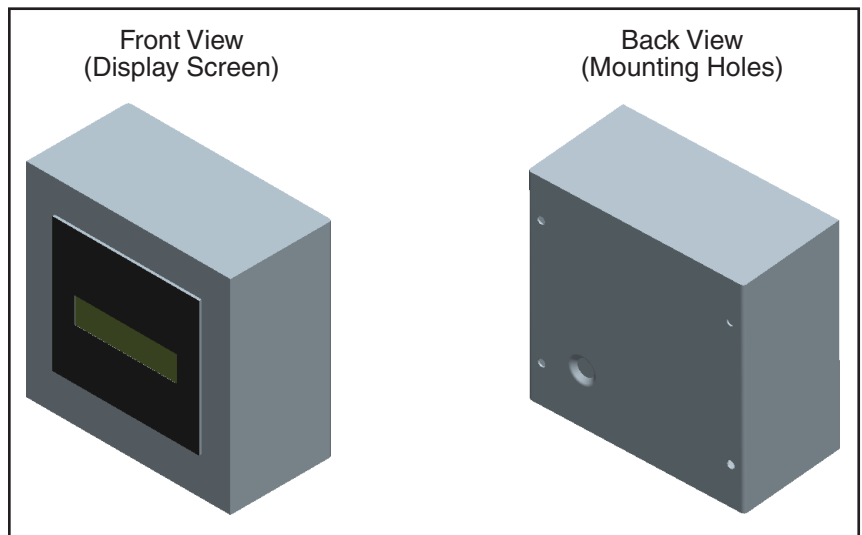

Figure 3 Mounting the Display

Mounting the SMDOPN

The SMDOPN is an open board product that requires field mounting in an enclosure or panel. To mount the display in a panel enclosure, refer to Figure 5 and Figure 6 and follow these steps:

1. Ensure that the display is not connected to power and turn off all power supplying the equipment it is to be mounted inside before working on or inside the equipment.
2. Use a properly rated voltage sensing device to confirm that power is off.
3. Using the template provided with your SMDOPN as a guide, drill holes and cut openings in the panel or enclosure.
4. Thread the membrane switch ribbon cable (A) through the rectangular opening.
5. Mount the display faceplate (B) onto the panel.

Figure 4 Mounting the Display in a Panel

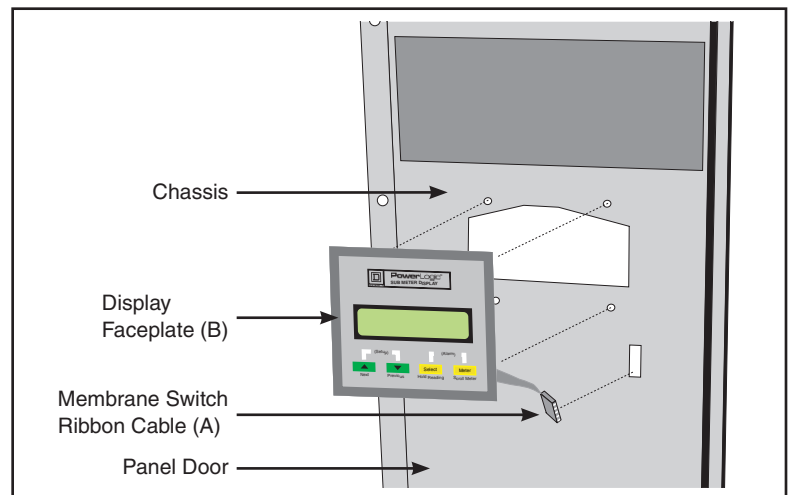

6. Secure the faceplate by screwing four threaded stand-offs (C) into the faceplate studs from the inside of the door.
7. Attach the display (D) to the threaded studs using the four #6-32 screws (E) provided.

8. Connect the membrane switch ribbon cable (A) to the membrane switch pin connector (F).

Figure 5 Display Components

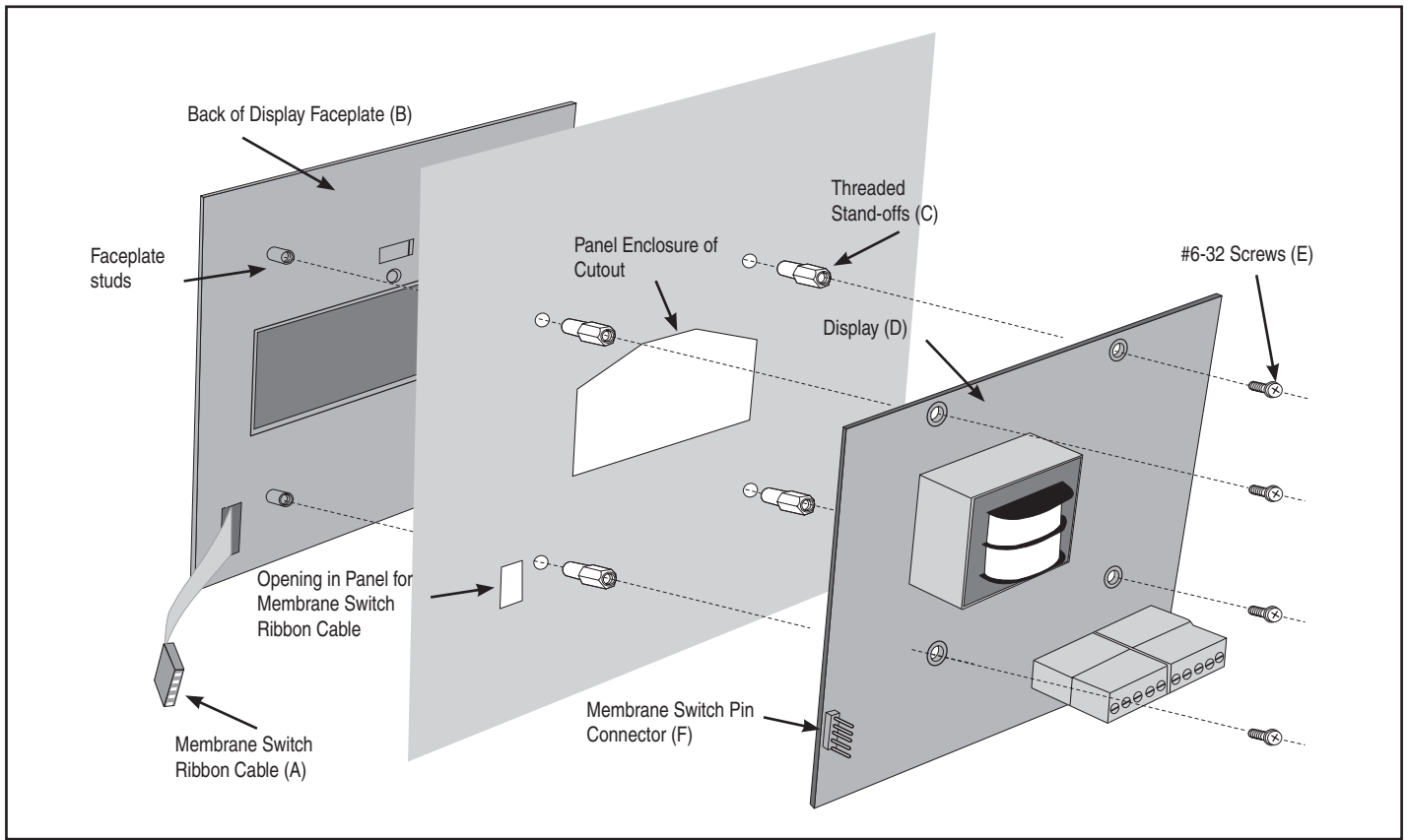

COMMUNICATIONS

The display resides on a Modbus network as a pass-through device (Figure 6). It provides an upstream and downstream communication connection. This allows for flexible data retrieval as the upstream options include RS-232 or RS-485. Figure 8 shows the downstream and upstream wiring scheme.

Figure 6 Upstream Monitoring Network Option

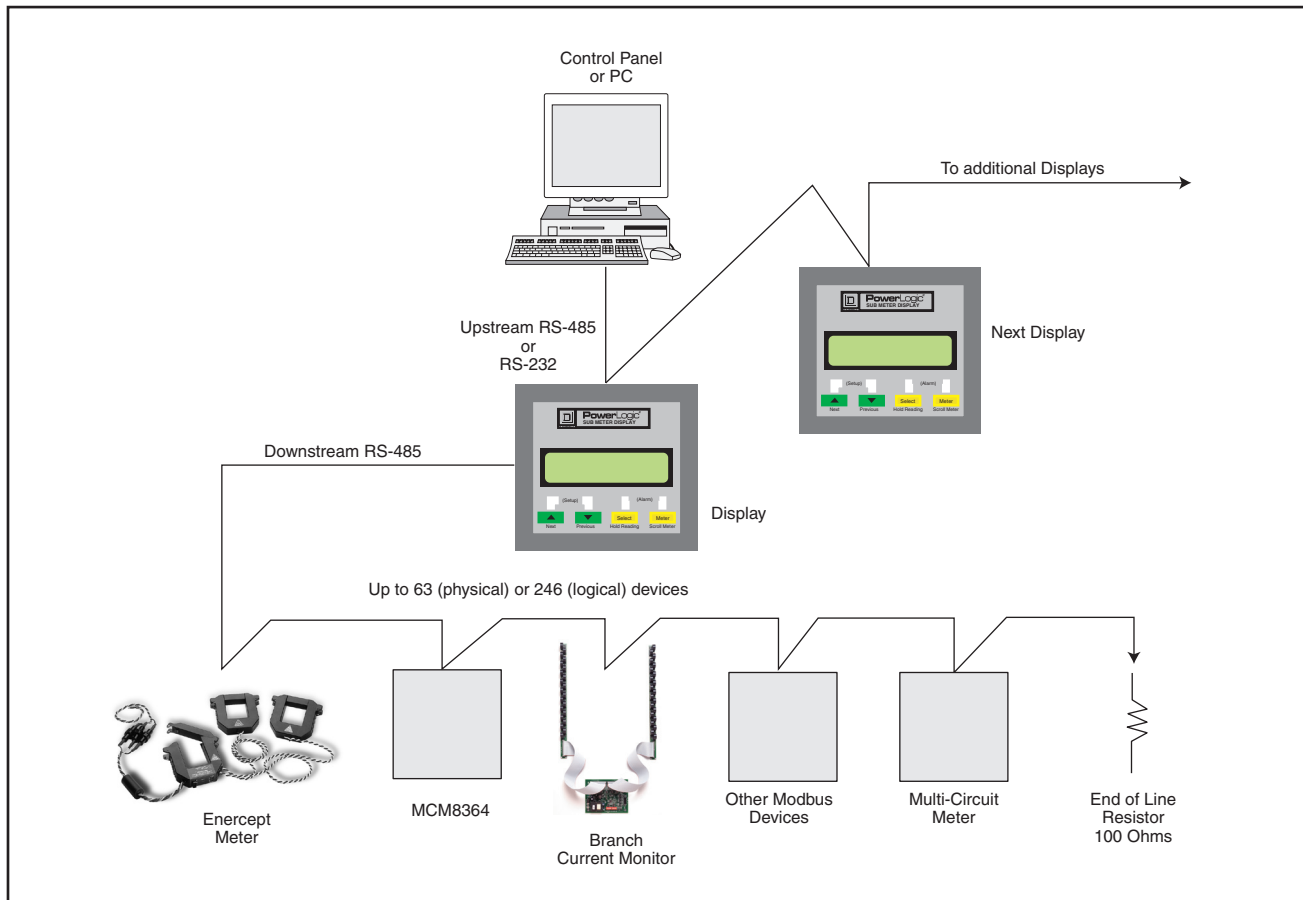

Downstream Devices

Observe these guidelines for downstream devices communications wiring:

- Connect devices on a daisy chain from the downstream RS-485 port.
- The display can support 32 devices with a maximum distance of 4000 ft. (1,219 m) to the last device.
- For devices on the daisy chain, follow the device distance limitations recommended by the manufacturer.
- Each device must have a unique address.
- The last device must be terminated with a terminator (Square D part no. 3090MCTAS485 or 100 ohm resistor).

Upstream Devices

Observe these guidelines for upstream devices communications wiring:

- A master computer or additional Sub Meter Displays can be connected on a daisy chain to the upstream RS-485 port.
- The maximum distance from the first upstream device to the last is 4000 ft. (1,219 m).
- Each device on this upstream connection as well as those downstream must have a unique address.
- The last upstream device must be terminated with a terminator (Square D PN 3090MCTAS485 or 100 ohm resistor).

Figure 7 Wiring of Downstream and Upstream Devices

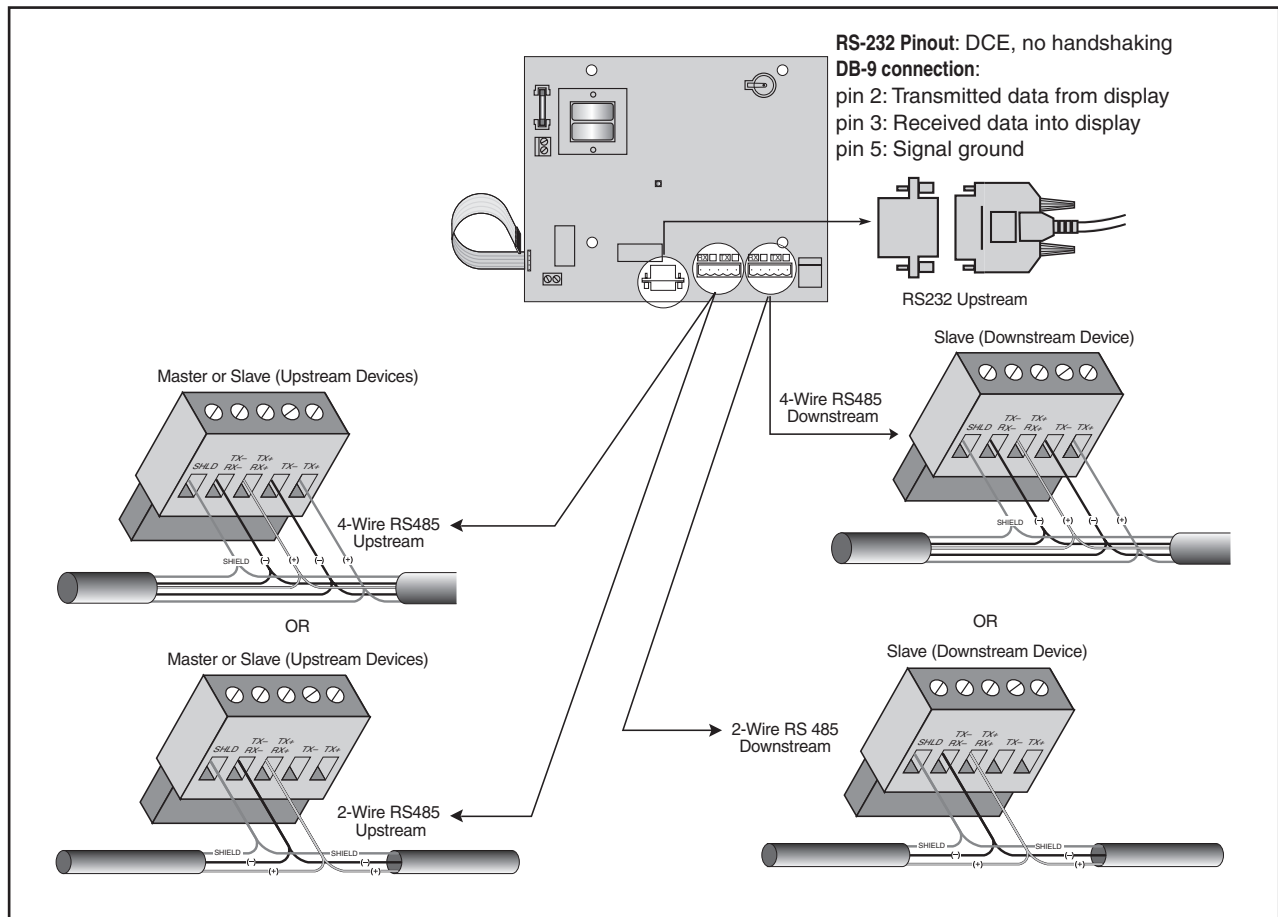

Terminating the Last Device in the Downstream Daisy Chain

Terminate the downstream network using the 3090MCTAS485 terminator to ensure reliable communications. Refer to Figure 8 and follow these steps:

1. Insert the wires of the daisy chain as shown in Figure 8 and insert the wires of the terminator into the holes of the RS-485 communications connector.
2. Using a small flat blade screwdriver, tighten the connector screws.
3. Plug the communications connector into the communications port of the last device on the daisy chain.

Figure 8 Installing the 3090MCTAS485 Terminator

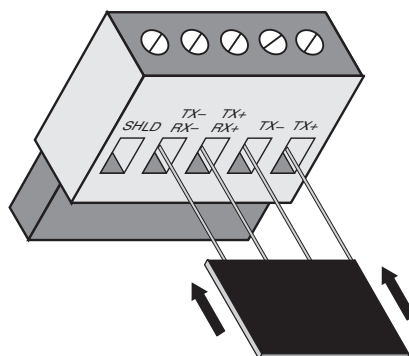

POWER CONNECTION

⚠ DANGER

HAZARD OF ELECTRIC SHOCK, EXPLOSION, OR ARC FLASH

- Apply appropriate personal protective equipment (PPE) and follow safe electrical work practices. See NFPA 70E.
- This equipment must be installed and serviced only by qualified personnel.
- Turn off all power supplying this equipment and the equipment it is to be mounted inside before working on or inside equipment.
- Always use a properly rated voltage sensing device to confirm that power is off.
- Replace all device doors and covers before turning on power to this equipment.

Failure to observe these instructions will result in death or serious injury.

To make the power connection, use either 120 Vac 2-wire or 12 Vdc connection as shown in Figure 9.

Figure 9 Power Connection Options

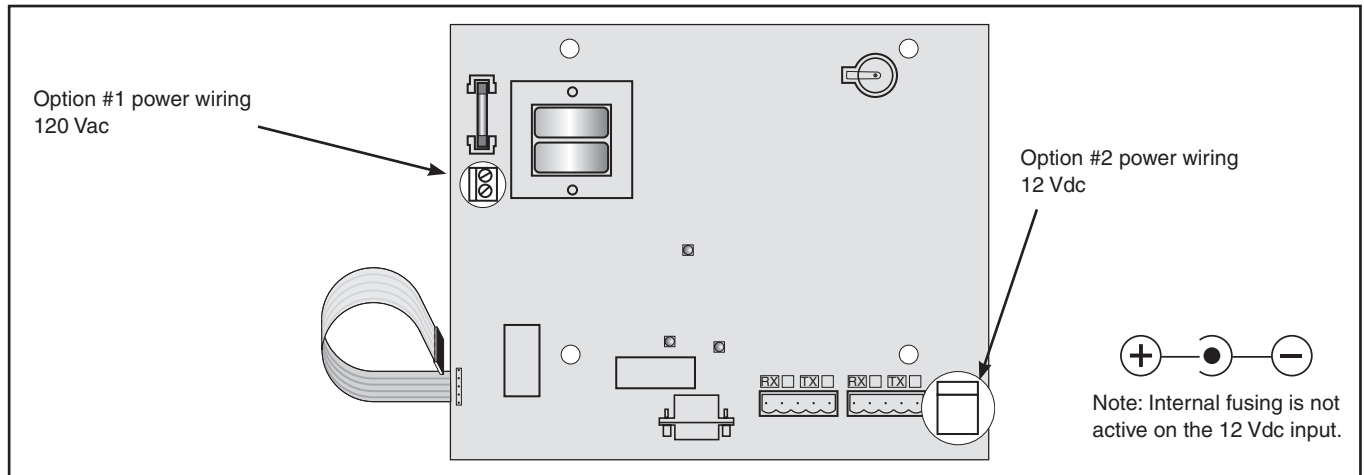

SETUP

Entering the Password

Use the Setup Mode to initialize and configure the display to the application requirements. The password for setup mode is “Select, Previous, Previous, Select, Next, Next” as shown in Figure 10. This password is fixed and cannot be changed.

Figure 10 Entering the Password for Setup Mode

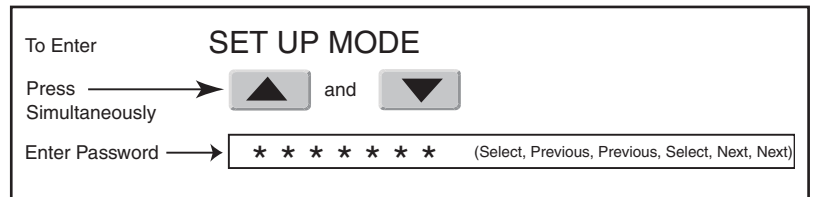

Initializing a System

To initialize a system, you must perform the Setup communications and Find Meters actions. See “Setup Communications Submenu” and “Find Meters Submenu”.

Viewing the Setup Mode Submenus

Once you are in the setup mode, press Next or Previous buttons to view submenus and then press Select for the submenu you want. Figure 11 illustrates setup mode button functions.

Figure 11 Setup Mode Button Functions

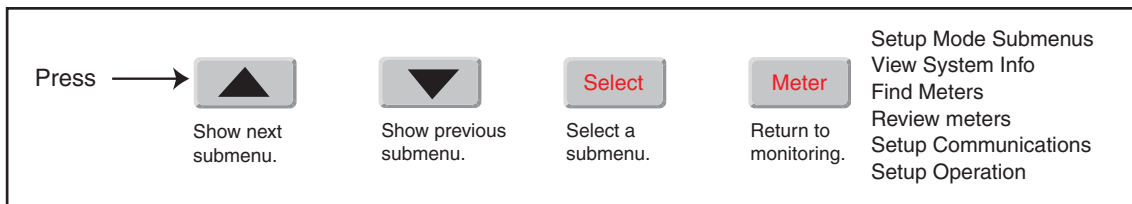

The following are the setup mode submenus:

View System Info Submenu

In setup mode, View System Info is the first submenu to display. Select “View System Info” for viewing information only (not modifying) such as the serial number or the customer support phone number. See Figure 12.



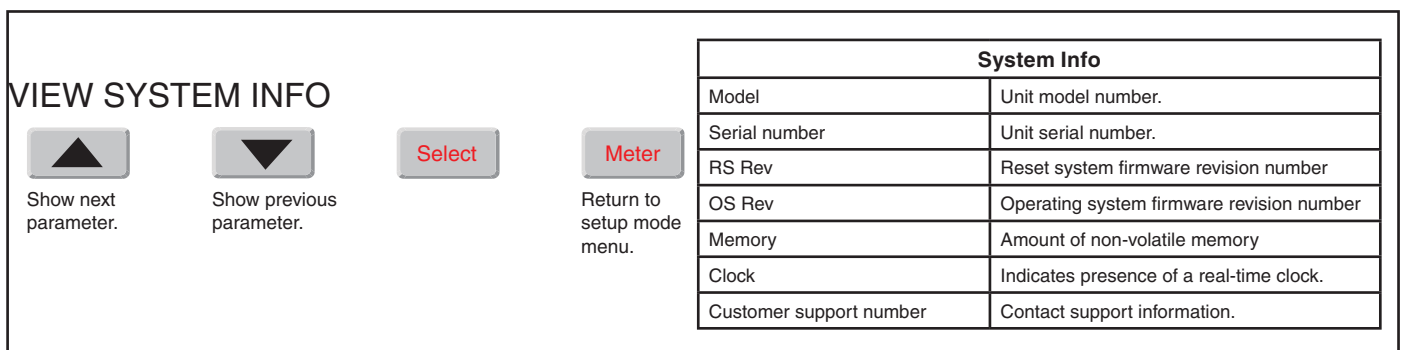

Figure 12 View System Info Button Functions



Setup Operation Submenu

Select “Setup Operation” to adjust operational parameters. Set backlight brightness for optimum visibility. You can set output relay and auxiliary input parameters based on the contact configuration of any (optional) remote devices. You can set the display to automatically rotate through the readings or you can rotate manually. See “Monitoring Mode” on page 15 for details. Refer to Figure 13 for Setup Operation parameters.



Figure 13 Setup Operation Button Functions

SETUP OPERATION				Operation Parameters
				Backlight Brightness (0-9), 0 = Backlight OFF
Show next parameter.	Show previous parameter.	Save setting and go to next parameter.	Return to setup menu.	Output Relays (ALARM = OPEN, ALARM = CLOSED)
				Auxiliary Input (ALARM = OPEN, ALARM = CLOSED)
				Rotate Parameters (YES, NO). See “Monitoring Mode”

Setup Communications Submenu

Select “Setup Communications” to adjust communications parameters. You must set downstream communications parameters to match the communications parameters of the downstream devices. When using an upstream master PC or control panel, you must set the appropriate Modbus address and upstream communications parameters. Refer to Figure 14.

Figure 14 Setup Communication Button Functions

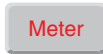
SETUP COMMUNICATIONS				Communication Parameters
				Modbus Address (1-247)
Show next parameter.	Show previous parameter.	Save setting and go to next parameter.	Return to setup menu.	Upstream Type (RS-485, RS-232)
				Upstream Duplex (2-wire, 4-wire). Not available for RS-232.
				Upstream Baudrate (2400, 4800, 9600, 19,200).
				Upstream Parity (NONE, ODD, EVEN).
				Downstream Duplex (2-wire, 4-wire)
				Downstream Baudrate (2400, 4800, 9600, 19,200)
				Downstream Parity (NONE, ODD, EVEN)

Find Meters Submenu

From Setup mode, selecting “Find Meters” initiates a search and identifies devices on the network. Exit the search by pressing any key. To make sure all meters are accounted for, do not exit until all active addresses have been counted.

Unsupported devices will be designated as “unknown device” and parameters will not be displayed. See Specifications section for supported devices.

Review Meters Submenu

From Setup mode, selecting “Review Meters” allows you to review all attached devices detected by the display. When you press REVIEW METERS, you see the first device found in the network. If the display does not detect any devices, you get a “No Meters” message. The following are example displays of devices detected by the FIND METERS function:

Example Display for an MCM6384 Meter

AD=002 BRD1 MTR7
MULTI-CRCT PRW 8

where AD=002 indicates Modbus address 2, BRD1 is the board name, and MTR7 is the meter name.

Example Display for a BCM42 Monitor

AD=061 BRD1
BRANCH CRCT AMPS

where AD=061 indicates Modbus address 061 and BRD1 is the board name.

Example Display for an Alta RH/Temp Sensor

AD=216
ALTA RH/TEMP

Example Display for an Unsupported Device

AD=123
UNKNOWN DEVICE

- Press Next to view the next meter. Continue pressing Next to scroll through the devices.
- Press Meter to return to the setup menu.

Monitoring Mode

Monitoring is the default mode for the Sub Meter Display. You can set up the display to automatically rotate (scroll) through parameters or you can set it to display a selected parameter continuously. You do this by selecting either Yes or No for “Rotate Parameters” in the Setup Operation submenu (see Figure 14. When set to Yes for “Rotate Parameters,” the display automatically rotates through the parameters of all supported devices and updates every four seconds. You can press Select to hold a reading to allow time to manually record the reading. When the reading is in hold, it will not be updated. Press any other button to return to monitoring mode (the display resumes automatically rotating through parameters of all supported devices). Figure 15 shows the monitoring mode button functions.

Figure 15 Monitoring Mode Button Functions

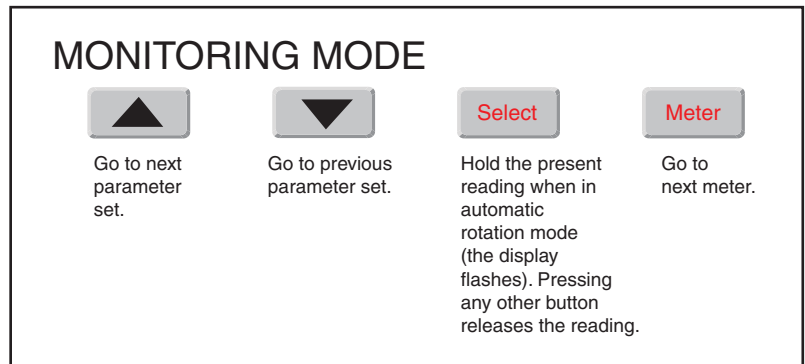

Viewing and Resetting Alarms

Alarm mode provides a means of viewing and resetting warning and critical alarms on the downstream network. To enter the alarm mode, press the Select and Meter buttons simultaneously. Figure 16 shows the alarm mode button functions.

Figure 16 Alarm Mode Button Functions

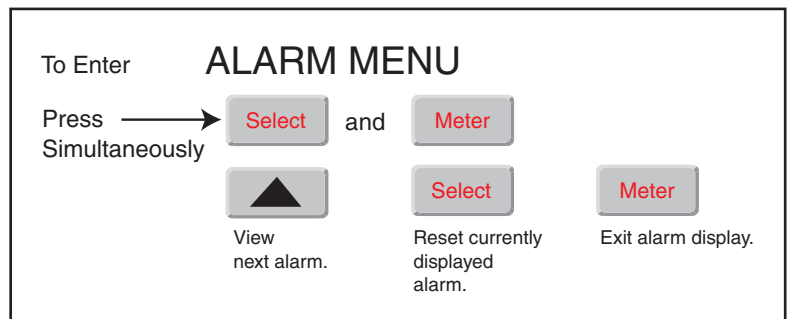

TROUBLESHOOTING AND MAINTENANCE

▲ WARNING

HAZARD OF ELECTRIC SHOCK, EXPLOSION OR ARC FLASH

- Apply appropriate personal protective equipment (PPE) and follow safe electrical work practices. See NFPA 70E.
- Turn off all power supplying this equipment and the equipment it is mounted inside before working on or inside equipment.
- Always use a properly rated voltage sensing device to confirm that power is off.
- Replace onboard lithium backup battery only with the same or equivalent type recommended by the manufacturer.
- Dispose of battery according to the manufacturer's instructions.

Failure to follow these instructions can result in death or serious injury.

If the display does not illuminate, check the fuses and voltage connections.

Changing the Battery

To change the onboard lithium backup battery (item 2, Figure 2 on page 3), follow these steps:

1. Verify that the power supply to the display is turned off.
2. Remove the old lithium battery, taking care not to short the battery terminals.
3. Install the new lithium battery (same or equivalent type recommended by the manufacturer).
4. Turn on the power supply to the display.

Changing the Fuse

If the fuse is blown, use only 250 Vac / 200 mA, Fast, 5x20 mm. Follow these steps to replace it:

1. Verify that the power supply to the display is turned off.
2. Remove the old fuse and replace it with the new one.
3. Turn on the power supply to the display.

QUICK REFERENCE MENU TREE

Figure 17 provides a quick reference menu tree.

Figure 17

Quick Reference Menu Tree

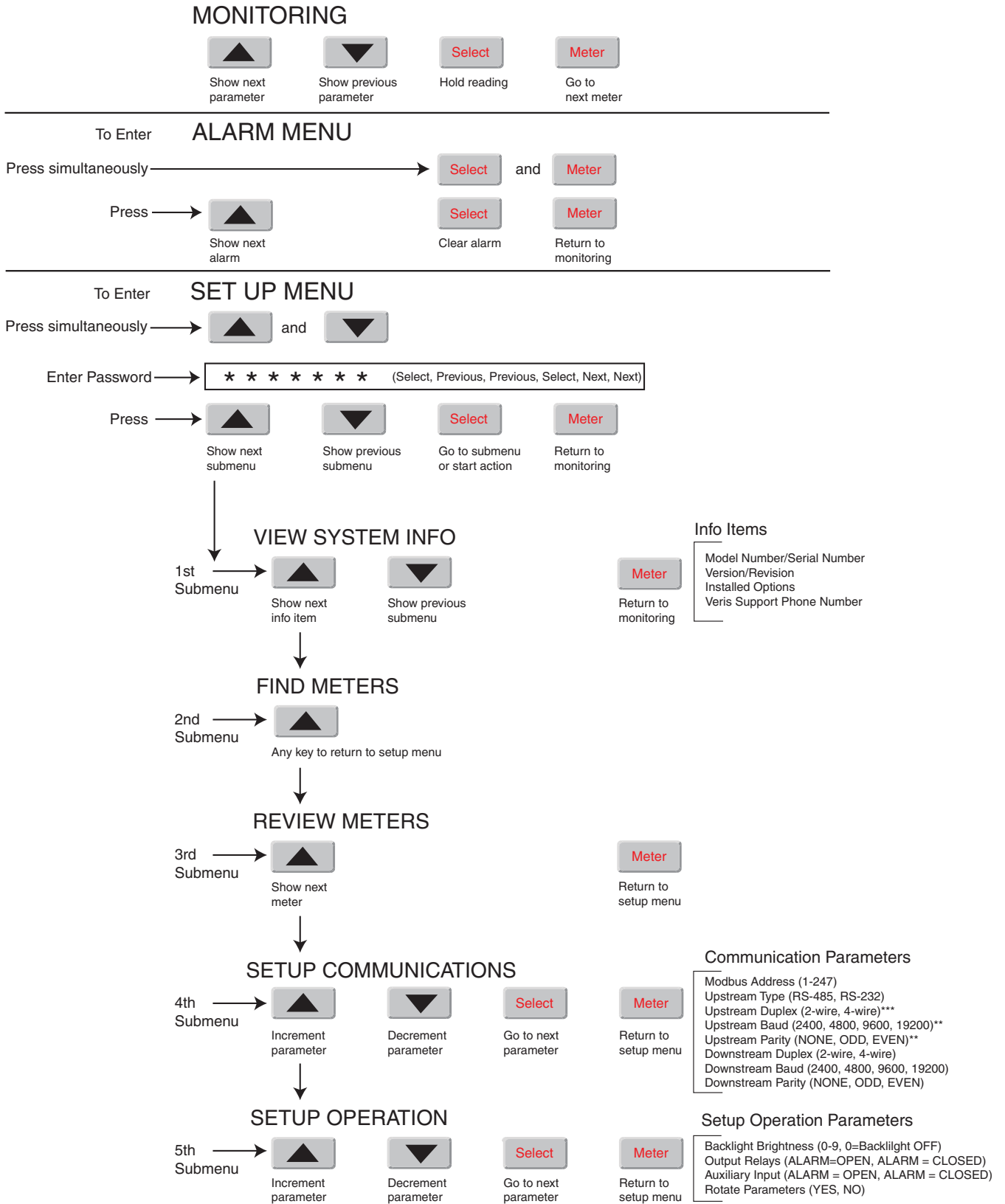

SPECIFICATIONS

Table 2 Specifications

Type	Description
General	
Operating Temperature Range	0 to 50°C (< 95% relative humidity, non-condensing)
Storage Temperature Range	-20°C to 70°C
AC Power Source	Dedicated 120 Vac, line-to-neutral, Fused, 200 mA at 250 Vac 5x20 mm Fast
AC Power Voltage Tolerance	+ 10/-25% (90-132 Vac)
AC Power Frequency	50/60 Hz
AC Power Termination	2-position cage clamp terminal block (max. wire size 12 gauge)
Alternate DC Power Source	12 Vdc unfused (Auxiliary input disabled)
Upstream Network Communications	
Interface	RS-485, RS-232
Protocol	Modbus RTU
Baud Rate	User-selectable 2400, 4800, 9600, 19,200
Parity	User-selectable NONE, ODD, EVEN
Communication Format	8-data-bits, 1-start-bit, 1-stop-bit
RS-485	1/4-load transceivers Duplex is user-selectable 2-wire or 4-wire 5-position depluggable connector
Downstream Network Communications	
Interface	RS-485
Protocol	Modbus RTU
Duplex	User-selectable 2-wire or 4-wire
Load	1/4-load transceivers
Baud Rate	User-selectable 2400, 4800, 9600, 19,200
Parity	User-selectable NONE, ODD, EVEN
Communication Format	8-data-bits, 1-start-bit, 1-stop-bit
Termination	5-position depluggable connector
LCD	
Size	1 x 4 inch visible area, 2 lines x 16 characters per line
Backlight	Green, User-adjustable brightness in 10 steps
Supported Modbus Devices	
Enercept Meters	
Multi-Circuit Monitor (MCM8364)	
Branch Current Monitor (BCM42)	
Alta Labs Network Temperature/Humidity Sensors (HXO-485, TXO-485, HXO/T-485)	

MOUNTING TEMPLATE

The following template may be used as a guide when installing the display.

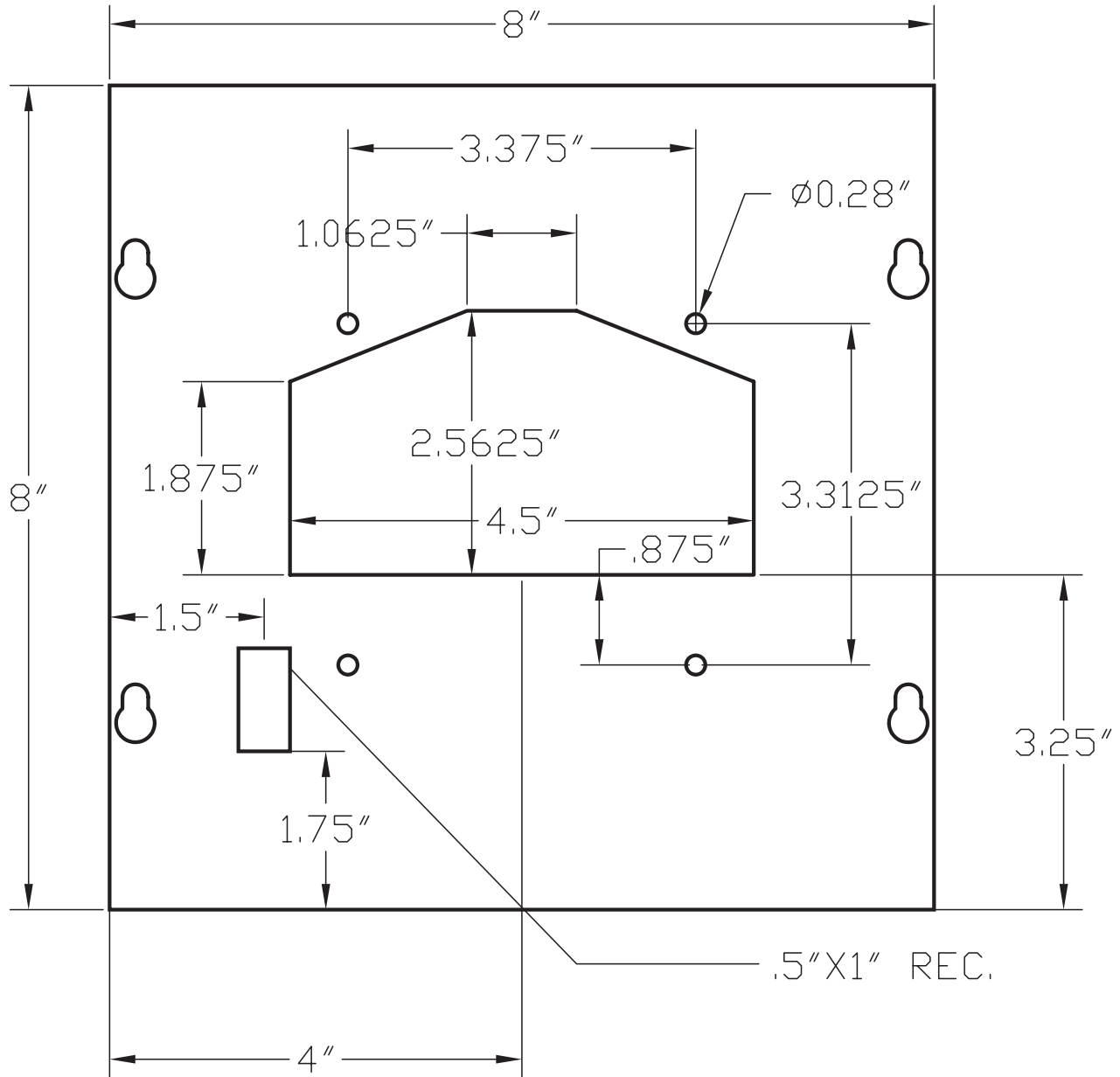

Schneider Electric

Power Monitoring and Control
 295 Tech Park Drive, Suite 100
 LaVergne, TN 37086
 +1 (615) 287-3400
 www.schneider-electric.com

As standards, specifications and designs develop from time, always ask for confirmation of the information given in this publication. Power Monitoring and Control, ION, ION Enterprise, MeterM@il and Modbus are either trademarks or registered trademarks of Schneider Electric or its affiliates. Other marks used herein may be the property of their respective owners.

