

WD3-007

3-Phase Power Controller and 3-Phase Stepping Motors

WD3-007.0401	110V _{AC}	24V-signal-input
WD3-007.0501	230V _{AC}	24V-signal-input
WD3-007.1401	110V _{AC}	5V-signal-input
WD3-007.1501	230V _{AC}	5V-signal-input

Supplier Documentation

Edition 07/2003

WD3-007

Edition : 07/2003

Overview	1
Functional description	2
WD3-007 specifications	3
Signal description	4
Mounting	5
Wiring	6
Setup	7
Status indicators and troubleshooting	8
Stepping motor parameters and characteristics	9

Safety information

This manual contains safety texts, which you should always observe for your personal safety and to avoid damage. These texts are identified and emphasized by a symbol and a heading which varies according to the degree of danger:



Danger

means that death, serious injury or severe damage **will** result if proper precautions are not taken.



Warning

means that death, serious injury or severe damage **may** result if proper precautions are not taken.



Caution

means that minor injury or damage may result if proper precautions are not taken.

Note

is used to give special emphasis to important information on the product, handling the product or the relevant part of the documentation.

Qualified personnel

Start-up and operation of the unit shall only be carried out by qualified personnel. Qualified personnel in the sense of the safety information in this manual are those persons who are authorized for setting up, earthing and tagging equipment, systems and circuits according to established safety practices.

Intended use

The following should be noted:



Warning

This equipment may only be used for the individual applications specified in this documentation and only in conjunction with BERGER LAHR approved or recommended third-party equipment and components.

Adequate transport, storage, installation and mounting as well as careful use and thorough maintenance are prerequisites for safe and reliable operation of the product.

Contents

- 1. Overview5**
- 2. Functional description6**
- 3. WD3-007 specifications8**
 - 3.1 Electrical data8
 - 3.2 Mechanical data10
 - 3.3 Ambient Conditions10
 - 3.4 Applicable standards, regulations, laws10
- 4. Signal description.....11**
 - 4.1 Pulse Interface.....11
 - 4.2 Signal timing diagrams.....13
- 5. Mounting14**
- 6 Wiring15**
 - 6.1 WD3-007 Wiring.....15
 - 6.2 Accessories16
- 7. Setup.....17**
- 8. Status indicators and troubleshooting.....19**
- 9. Stepping motor parameters and characteristics.....21**
 - 9.1 Basic concepts.....21
 - 9.2 Torque characteristics22
 - 9.3 Special torque diagrams23

1.Overview

The WD3-007 is a power controller for controlling a BERGER-LAHR 3-phase stepping motor.

The recommended motor series includes the following 3-phase stepping motors:

Table 1-1 Berger-Lahr stepping motors

Motor type	Nominal torque	Nominal Line-Voltage	Nominal current	Recommended HEX-switch position	Remarks
VRDM 397 LN	2 Nm	110 V	4.4 A	B	
VRDM 3910 LN	4 Nm	110 V	5.0 A	D	
VRDM 3913 LN	6 Nm	110 V	5.0 A	D	
VRDM 31117 LW	10 Nm	110 V	4.1 A	A	reduced speed
VRDM 31122 LW	15 Nm	110 V	4.75 A	C	reduced speed
VRDM 397 LW	2 Nm	230 V	1,75 A	9	
VRDM 3910 LW	4 Nm	230 V	2,00 A	B	
VRDM 3913 LW	6 Nm	230 V	2,25 A	D	
VRDM 31117 LS	12 Nm	230V	2,45 A	4	S =special motor
VRDM 31122 LS	16,5Nm	230V	2,45 A	4	S = special motor

For torque diagrams of motor types VRDM 31117 and 31122 see chapter 9.3 (torque diagrams)

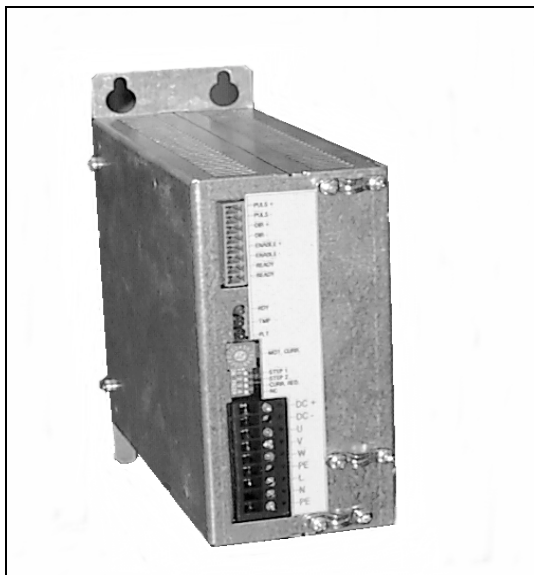

Figure 1-1 WD3-007 power controller

Reference literature

Dr.-Ing. Ralf Gfrörer BERGER LAHR and two co-authors.
Expert-Verlag: ISBN 3-8169-0678-8

2. Functional description

The WD3-007 power controller has interfaces, switches and indicating elements arranged on the front panel as shown in figure 2-1.

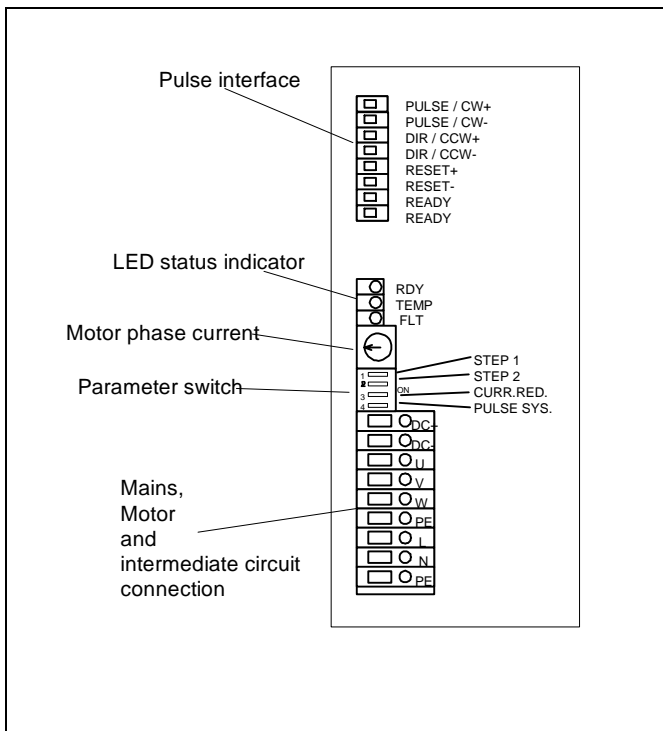

picture 2-1 WD3-007 front panel

Pulse interface

The pulse interface can be used for controlling the power controller from the master positioning unit using clock signals. With each clock pulse, the motor moves one step.

Input signals: PULSE (clock) or CW (clockwise)
 DIR (direction of motor rotation) or CCW (counter clockwise)
 RESET (disable power controller)

Output signal: RDY (readiness)

Mains, Motor and intermediate circuit connection

The mains connection supplies the power controller with 110 V or 230 V AC. The intermediate circuit connection may be used for dissipating surplus recovery energy of the motor.

- Current and parameter switches** These switches are used for setting the motor phase current, the number of steps (500, 1000, 5000, 10 000 steps/revolution), the pulse input selection, and the current reduction (to 60 % at motor standstill).
- LED status indicators** To indicate readiness and any malfunctions (short-circuit between motor phases, supply overvoltage/undervoltage, power controller overtemperature).
- Fan** A fan is installed in the WD3-007 power controller.
- Internal counter backup** If main power fails, the actual position of the internal counter is stored in an internal memory. The stored counter status is read back, after next main power on.

The counter status is also stored, if a malfunction occurs and during RESET input is energized.

If parameter switch No.4 (pulse input system) is toggled during power off, the internal counter starts with step 0 (zero-position).

The block diagram shown in figure 2-2 illustrates the most important functional groups of the WD3-007 power controller.

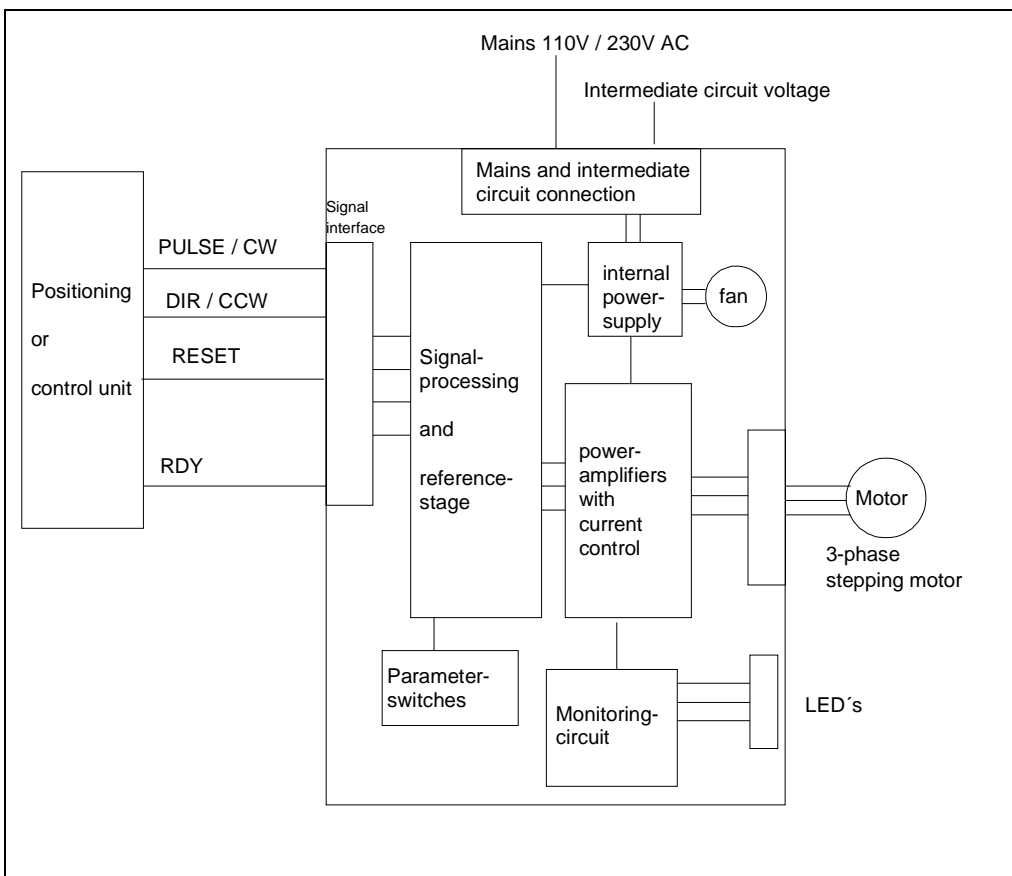

Figure 2-2 WD3-007 Block diagram

3. WD3-007 specifications

3.1 Electrical data

Mains connection	Mains voltage	110 V or 230 V AC Tolerance: -30% / +20% Frequency range: 45 Hz to 66 Hz
	Internal fuse	6,3 A
	Input current max.	5 A (110 V-type) 2,5 A (230 V-type)
	Inrush current	100 A max.
	Leakage current (IEC60990)	motorcable <5m : <15mA motorcable 5-50m : <90mA
	Mains buffering time	> 1 ms at motor standstill
	Maximum power loss	80 W
	Intermediate circuit connection	Intermediate circuit voltage
ON-OFF-ON cycle (Mains)		> 5 s
Motor connection	Phase current	1.35 A to 5.5 A (110V-type) 0.66 A to 2.5 A (230V-type)
	Motor voltage (connected to mains)	3 x 155 V (110V-type) 3 x 325 V (230V-type)
	Motor cable shield	Trailing cable with double 3 x 1.5 CC Length Wire cross-section Capacity
		50 m max. 3 x 1.5 mm ² < 10nF / 100m

Pulse interface

Note

All signals are PELV (protected extra low voltage) signals as defined by VDE 0160.

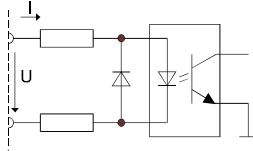

Pulse interface inputs

PULSE / CW (clock), DIR / CCW (sense of rotation), RESET (power controller Disable).
For a signal description, see chapter 4.

	5V inputs WD3-007.1401 WD3-007.1501	24 V inputs WD3-007.0401 WD3-007.0501
Voltage Control		
$U_{high, min}$	2.5 V	20 V
$U_{high, max}$	5.25 V	30 V
$U_{low, max}$	0.4 V	3 V
$U_{low, min}$	-5.25 V	-30V
$I_{max} = 30 \text{ mA}$		
Current Control		
$I_{high, min}$	7 mA	7 mA
$I_{high, max}$	15 mA	15 mA
$I_{low, max}$	0.2 mA	0.2 mA
$I_{low, min}$	-25 mA	-25 mA
$U_{max} = 5.25 \text{ V}$		

Note

It is recommended to use push-pull control for reasons of noise suppression.

Pulse interface output

RDY (readiness). For a signal description, see chapter 4.

Relais-Output

U_{max} : 36 V max.

I : 10mA to 200 mA resistive load

3.2 Mechanical data

Dimensions (H x W x D)	145 x 66 x 155 mm
Weight	1100g

3.3 Ambient Conditions

Non-condensing	
Transport and storage temperature	-40°C to +70 °C
Operating temperature	0°C to +50 °C
Free fall	non-packaged : 100 mm packaged : 500 mm
Drop and topple admissible	
Continuous sound pressure level	<50 dB(A)

3.4 Applicable standards, regulations, laws

The following standards, regulations and laws must be observed when operating the WD3-007 power control :

- DIN EN 60204 Part 1 (VDE 0113) Electrical equipment of machines
- DIN VDE 0100 Erection of power installations with nominal voltages up to 1000 V
- DIN VDE 0106 Protection against electric shock
- DIN VDE 0470 (and: IEC 529) IP degrees of protection
- DIN VDE 0875 (EN 55011) Radio interference suppression of electrical appliances and systems
- DIN EN 954-1 Safety of machines
Safety-related parts of control systems
General design guidelines

4. Signal description

4.1 Pulse Interface

The pulse interface has three optocoupler inputs and one relay output.

The signal timing of the inputs/outputs is described in chapter 4.3

INPUT SIGNALS

The power controller is designed for the following 2 different pulse input systems :

- **1-pulse input system (PULSE/DIR function)**
- **2-pulse input system (PULSE Up/Down function)**

Use parameter switch (see chapter 7) to select the right pulse-input system. If PULSE/DIR-function is selected, you have to observe the timing diagram in chapter 4.2 (figure4-2). If PULSE UP/DOWN-function is selected, no propagation or delay time is necessary (see chapter 4-2, figure 4-3).

PULSE / CW

To start motor shaft rotation, rectangular clock pulses must be supplied to the PULSE input.

1-pulse input system : Each positive pulse edge triggers one motor step. The sense of rotation is preset with the direction input (DIR).

2-pulse input system : A positive pulse edge triggers one clockwise (CW) motor step.

DIR / CCW

1-pulse input system : When the DIR signal input is deenergized, the motor turns in a clockwise direction (as seen from front towards motor shaft). When this signal input is energized, the motor turns in a counterclockwise direction (as seen from front towards motor shaft).

2-pulse input system : A positive pulse edge triggers one counterclockwise (CCW) motor step.

Note

The sense of rotation can also be inverted by interchanging two motor phase leads.

RESET (Disable) When the RESET input is **deenergized**, the power controller is enabled. After approx. 500 ms, the power controller reports readiness via the RDY- outputs and the motor is energized. When the RESET input is **energized**, the internal step count status is stored (see also chapter 2 <internal counter backup>).

Output Signal :

RDY (readiness) When the RESET input is deactivated, the power controller reports readiness via the RDY- output. When the power controller is ready, the RDY- output has low resistance(Internal Relay is closed). In case of a power controller fault, or if the power controller receives a RESET signal, the RDY- output has high resistance (Internal Relay is open).

4.2 Signal timing diagrams

The timing diagrams below illustrate the timing of the input/output signals of the pulse and signal interfaces.

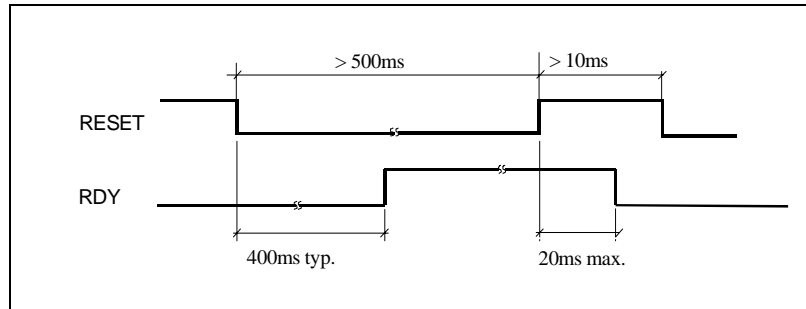

Figure 4-1 : RESET / RDY timing diagram

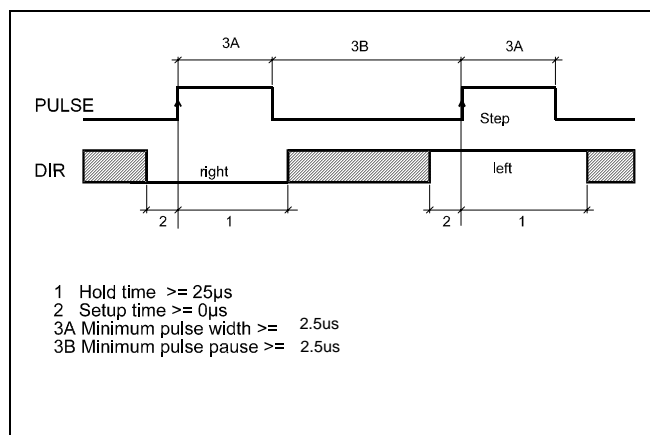

Figure 4-2 : PULSE / DIR timing diagram (1-pulse input system)

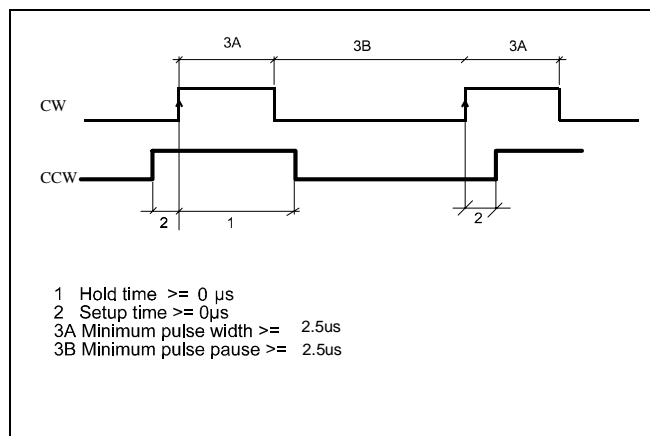

Figure 4-3 : PULSE UP/DOWN timing diagram (2-pulse input system)

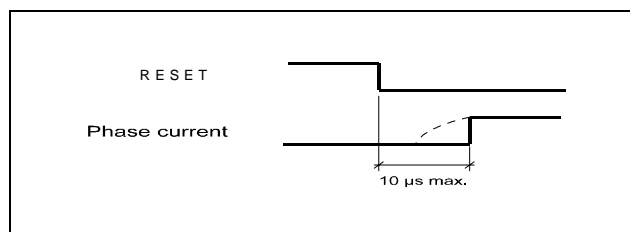
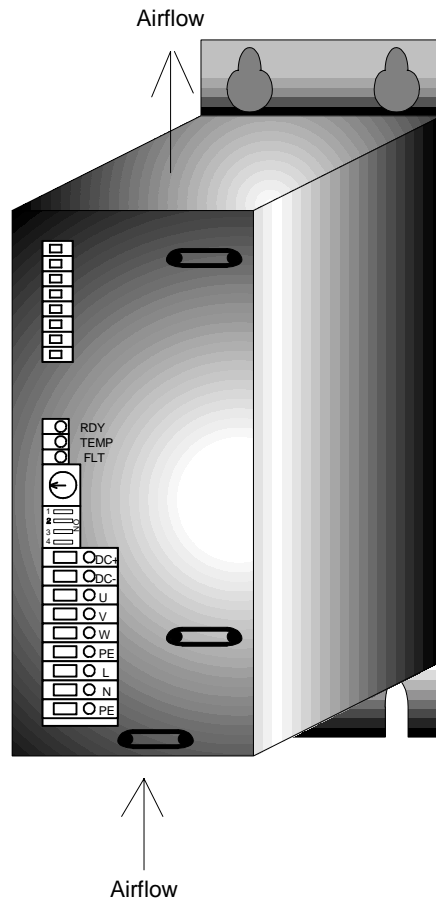

Figure 4-3 : RESET and motor phase current timing diagram

5. Mounting



Danger

Voltage must be disconnected whenever mounting work or setting is carried out.

Figure 5-1 : Mounting the WD3-007 power controller

Mount the WD3-007 as follows:

1. Hook the WD3-007 to the mounting screws and let it down.
2. Fasten the 4 screws.

Note

A fan is installed in the power controller. When mounting, leave 5 cm of space for the air flow at the top and bottom of the unit.

Units must not be mounted on top of each other without a partition.

6 Wiring

6.1 WD3-007 Wiring

Mains connection The unit has a built-in fuse (6,3 Amperes).

The additional PE terminal must be connected to the housing (bottom) on account of the high leakage currents.

In order to fulfil the EMC requirements, a mains filter must be inserted into the mains supply line motor (see accessory table chapter 6.2).

Intermediate circuit connection When the motor decelerates mechanical energy is transformed into electrical energy. Consequently the intermediate circuit voltage may rise. When considerable masses have to be decelerated within a short time, an additional external Capacitor may be required to ensure that the voltage does not exceed the upper limit of 400 VDC (230 V-type) respectively 190 VDC (110 V-type). For single-axis systems the recommended value for the external capacitor to be connected to DC+ and DC- is between 500uF and 2000 uF/450V. In multi-axis systems alternatively the intermediate circuit connections DC+ and DC- of the individual axis can be interconnected to summarize the internal capacities, provided the power controllers have identical AC-voltage.

Motor wiring

The shield drain wire of the motor cable must be connected on the motor and the device end.

The protective earth connection on the motor is usually established via the motor fastening components. If this connection should be insufficient, the protective conductor may be connected to the external terminal of the motor.

A shielded 3-wire standard cable should be used for connecting the motor (see accessory table chapter 6.2).

The cable shield must be clamped with the motor cable gland on the motor and connected to the strain relief spring on the power controller (remove the sheath at the strain relief element).

Behind the strain relief element, the cable sheath should reach as far as possible to the motor connection on the WD3-007.

At the cable entry into the cabinet, the cable shield must be connected to a grounded shield terminal (remove the sheath at the terminal).

Pulse interface For Pulse interface a shielded Signal cable is recommended. (see accessory table chapter 6.2).

Note

It is essential to use original BERGER LAHR accessories, to fulfil the EMC regulations and the CE conformity.

6.2 Accessories

Accessories	Order number	Ordering information
Mains filter for one axis with single-phase power supply	62501100200	FF 343
Motor cable (non-terminated): Length 5 m Length 10 m Length 20 m Length 50 m	62501313005 62501313010 62501313020 62501313050	
Cable for pulse interface: (max. length 35 m)	62501422035 (35m)	

7. Setup

After mounting and wiring, and with the mains voltage disconnected, make the following adjustments on the power controller:



Danger

The settings may only be made with the power supply disconnected.

Changing switch positions during mains on and RESET deenergized may cause power controller malfunction.

Death will result, when operating with blank setup tools (e.g. blank screw drivers).

1. Set the motor phase current on the selector switch.

Position	Current 110V-Type	Current 230V-type
0	1,35	0,6
1	1,65	0,8
2	1,90	0,9
3	2,20	1,0
4	2,45	1,1
5	2,75	1,3
6	3,00	1,4
7	3,30	1,5
8	3,60	1,6
9	3,90	1,8
A	4,15	1,9
B	4,40	2,0
C	4,70	2,1
D	5,00	2,3
E	5,20	2,4
F	5,50	2,5

Recommended switch positions for 110V-motors:

	397 LN	3910 LN	3913 LN	31117 LW	31122 LW
torque max.	2Nm	4Nm	6Nm	10Nm	15Nm
Switch-Position	B	D	D	A	C

Recommended switch positions for 230V-motors:

	397 LW	3910 LW	3913 LW		
torque max.	2Nm	4Nm	6Nm		
Switch-Position	9	B	D		



Warning

Higher phase current settings than those specified above are not permitted since they may cause motor overheating.

Lower phase current settings are admissible, however, they will result in a lower motor torque.

2. Set the number of steps,
the current reduction at standstill (to 60% after 100ms) and
the pulse input system (see also chapter 2 <internal counter backup>)

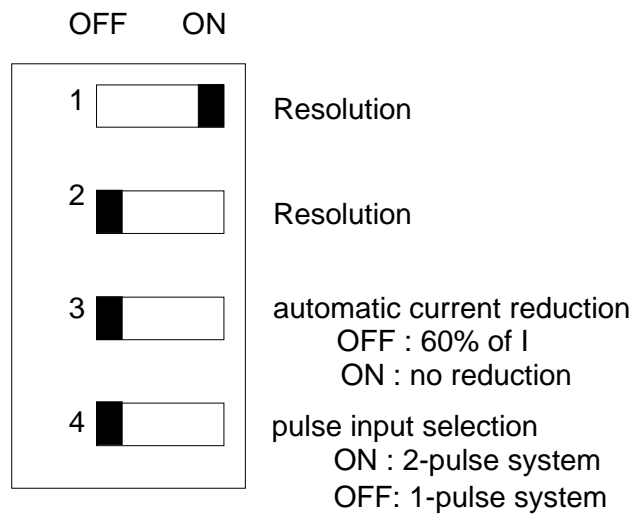

Resolution	Switch 1	Switch 2
500	OFF	OFF
1000	ON	OFF
5000	OFF	ON
10000	ON	ON

Switch-settings shown in delivering-status.

3. Connect the mains voltage
4. Make sure that the RESET input is deactivated.
When the power controller operates properly, the LED RDY lights and the RDY - output indicate readiness.
5. Clock pulses can now be supplied.
With each clock pulse, the motor performs one step (see signal description chapter 4).



8. Status indicators and troubleshooting



Danger

If a malfunction occurs, the motor is deenergized and the power controller indicates not ready status (LED RDY goes out). The RDY-output has high resistance.

A motor does not have any holding torque when deenergized. This may cause undesirable effects.

- green  RDY (Ready)
- red  TMP (Overtemperature)
- red  FLT (General Failure)

All malfunctions causes the storage of then internal step counter.
(see also chapter 2 <internal counter backup>)

Indication	Cause	Rectification
FLT (FAULT) lights	Short-circuit between motor phases	<ol style="list-style-type: none"> 1. Switch off mains voltage. 2. Check motor wiring; replace motor if necessary. 3. Switch on mains voltage.
	Under-/Overvoltage	Check mains supply
TMP (TEMP) lights	Overtemperature	<ol style="list-style-type: none"> 1. Ensure sufficient air supply, or reduce ambient temperature. 2. After cooling down: Switch mains voltage or RESET signal on and off again.
RDY (READY) lights	Unit is ready for operation.	-
FLT and RDY light	RESET input is active.	Deactivate RESET input.

**Other malfunctions
that are not
indicated**

Malfunction	Cause	Rectification
None of the LEDs light	Mains voltage not available	Check mains voltage and mains connection wiring.
Motor does not rotate and does not have a holding torque	Motor line(s) interrupted	With the mains voltage disconnected, check the motor wiring.
Motor does not rotate but does have a holding torque	No clock signal present on PULSE input	Supply clock signal to PULSE input.
Motor turns in incorrect direction	Motor phases interchanged	Connect the motor phases properly.
	DIR signal input set incorrectly	Invert signal on DIR input.
Motor torque is too low (motor slips)	Motor phase current set too low	Set phase current correctly.
	Acceleration ramp too steep	Reduce acceleration ramp on control unit.
	The drive is mechanically blocked	Eliminate mechanical blocking.
	Connected motor's rating is insufficient	Connect a more powerful motor.

9. Stepping motor parameters and characteristics

9.1 Basic concepts

Step angle	A step refers to a motor shaft rotation by the step angle α ; the step is initiated by a control pulse.
Number of steps	The number of steps specifies the number of steps the rotor performs per revolution. The number of steps can be adjusted for a 3-phase stepping motor.
Holding torque	The rotor is held in each step position due to the DC excitation of the coils unless its holding torque M_H is exceeded on the motor shaft.
Systematic angle tolerance	The systematic angle tolerance per step $\Delta\alpha_s$ specifies the maximum number of angular minutes a step may deviate from the nominal step angle.
Control and stepping frequency	With a continuous sequence of control pulses at a control frequency f_s , the motor shaft will also execute a sequence of steps at the (same) stepping frequency f_z .
Speed	From a specific control frequency onwards (depending on motor type and mechanical load) the step-by-step movement of the motor shaft verges into a continuous rotary movement. The following then applies for the speed n of the motor: $n = \alpha/360^\circ \cdot f_z \cdot 60 \text{ r.p.m. } (f_z[\text{Hz}])$
Torques	If the rotating motor shaft is subjected to a load torque M_L , the motor will continue to follow the control frequency synchronously unless the load torque exceeds a certain limit, i.e. the maximum torque at maximum slew stepping rate M_{Bm} . In this case, the rotor cannot follow the control frequency any more, and a step "loss" will occur, where control frequency and stepping frequency are no longer identical. Such a situation can be avoided by selecting the correct motor and by controlling it correctly.

9.2 Torque characteristics

The maximum torque at maximum slew stepping rate M_{Bm} of a stepping motor depends on its type size, on the type of electrical control and, in particular, on the stepping frequency. This relationship is specified as a characteristic curve for each stepping motor system.

The maximum torque at maximum slew stepping rate M_{Bm} can be output by the motor at low stepping frequencies; the higher the stepping frequency, the lower the maximum torque at maximum slew stepping rate.

The operating range of the motor given by the maximum torque at maximum slew stepping rate is divided into the starting range and the acceleration range. In the starting range, the motor is able to follow a suddenly activated or interrupted control frequency without a stepping error; in the acceleration range, the control frequency may only be changed gradually (frequency ramp) in order to prevent the motor from losing synchronicity.

The starting range is limited by the characteristic curve of the starting limit frequency f_{Am} (start/stop characteristic): Without load, the motor can start at the maximum starting frequency f_{Aom} ; with a load, the starting frequency is reduced.

Load inertia

The size of the starting range also depends on the load inertia J_L exerted by the load on the motor shaft. With J_L increasing, the start/stop characteristic shifts towards lower frequencies. The start/stop characteristic shows the maximum starting frequency f_{Aom} as a function of the load inertia J_L . If a load inertia and a load torque are present at the same time, the starting limit frequency f_{Am} is determined by moving the start/stop characteristic in the torque diagram in parallel to the left until the maximum starting frequency f_{Aom} corresponds to the one determined in the J_L diagram (see figure).

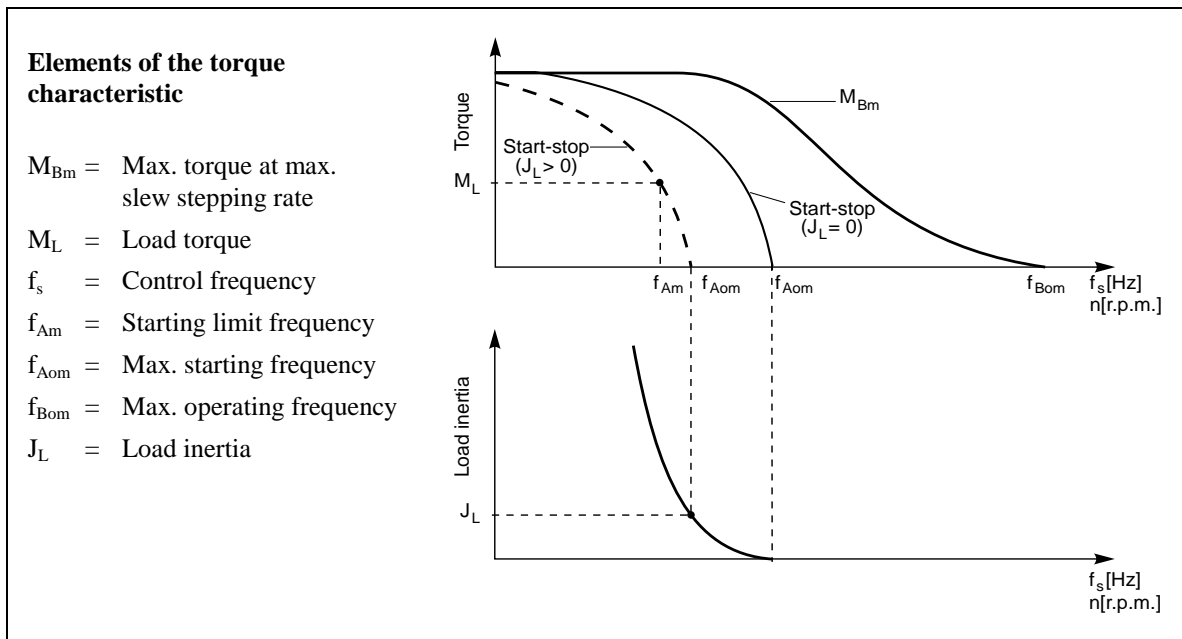

Figure 9-1 : Elements of the torque characteristic

9.3 Special torque diagrams

The motortypes VRDM 31117 and VRDM 31122 should only be used in applications with reduced speed. The torque diagrams for this motors are shown below. All other motors are BERGER-LAHR standard motors with their guaranteed torques.

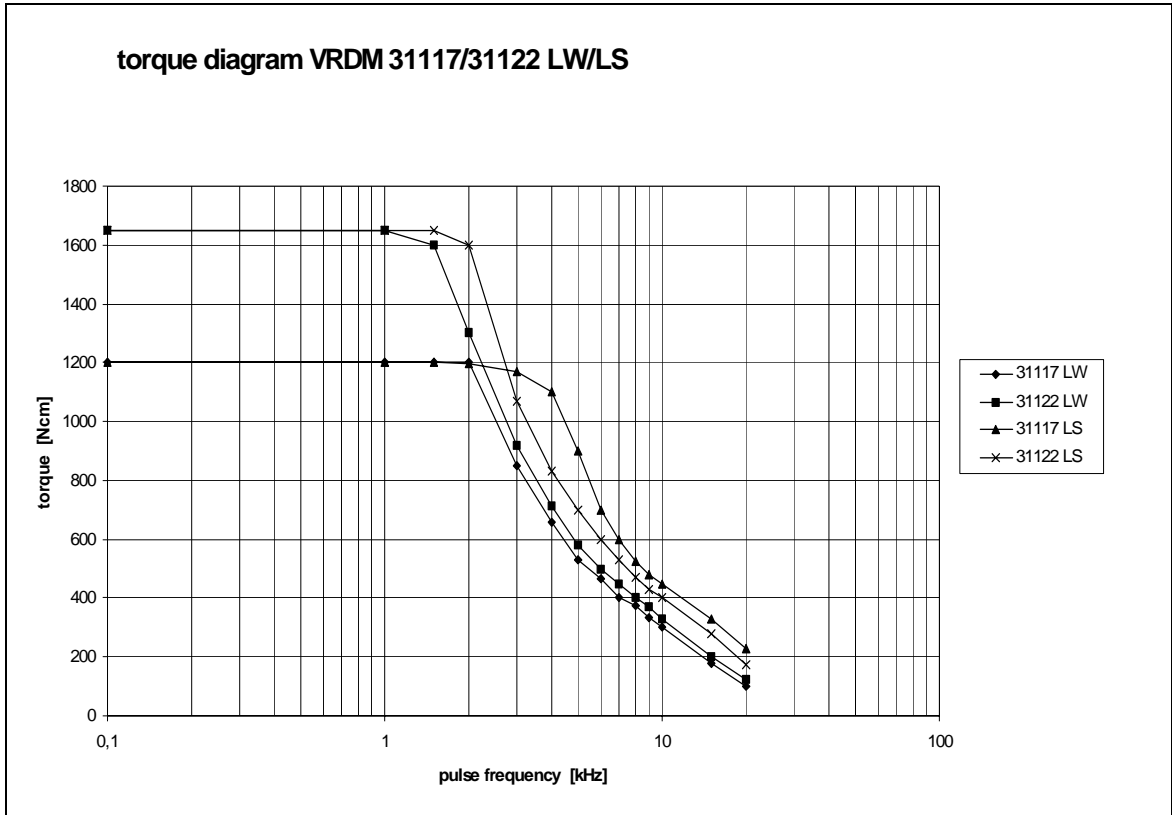

Figure 9-2 : torque characteristic

operation with 110VAC : VRDM31117 LW and 31122LW
 operation with 230VAC : VRDM31117 LS and 31122LS
 resolution : 1000 steps/rev.