

Electronic Room Temperature Sensors
General Instructions

APPLICATION

Electronic sensing of room temperature at wall locations.

SPECIFICATIONS

Sensing Element: Temperature sensitive Balco resistance.

TS-8101 Series, 1000 ohms $\pm 0.1\%$ at 70°F (21°C); changes 2.2 ohms per 1°F (0.5°C at 70°F (21°C).

TS-811 Series, 1000 ohms when control dial is set to sensed temperature.

Control Dial Range: See Table 1.

Environment:

Ambient Temperature Limits,

Shipping and Storage -40 to 160°F (-40 to 71°C).

Operating 40 to 140°F (4 to 60°C).

Humidity, 5 to 95% RH, non-condensing.

Locations, NEMA Type 1 indoor only.

Connections: Coded screw terminals.

Cover: Beige plastic.

Mounting: Wall.

Dimensions: 4-3/8" high x 2-3/4" wide x 1-5/8" deep (111 mm x 70 mm x 43 mm).

STANDARD

TS-8111 °F

TS-8111-116 °C

TS-8111-770 °F only

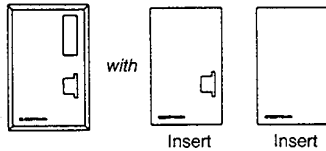

OPTIONS (TS-8111 & TS-8111-116 only)

(for quantities of 24 or more of each part number)

Add "dash-number" (-XXX) suffix to base part no. for desired option.

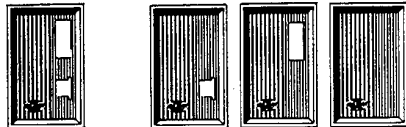

°F TS-8111-399 -400 -403†† -404††
 °C TS-8111-398 -410 -413†† -414††

††5/64" Allen screw used to secure cover.

Table-1 Specifications.

Part Number	Company Identification	Control Dial Range	Cover Configuration
TS-8101	Schneider Electric	-	Blank
TS-8101-770	Robertshaw	-	
TS-8111	Schneider Electric	55-85°F	Standard cover and two inserts (see Options also)
TS-8111-116		13 to 29°C	
TS-8111-770	Robertshaw	55-85°F	Standard cover and two inserts

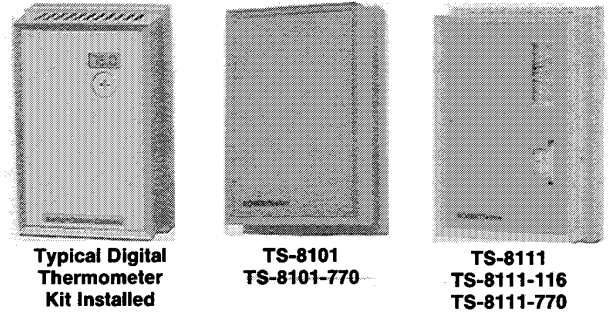

ACCESSORIES

- AT-61 Series Brushed bronze cover plates
- AT-70 Series Brushed bronze cover plates (TS-81XX-770)
- AT-82 Series Digital thermometer cover kit
- AT-82-770 Digital thermometer cover kit (TS-81XX-770)
- AT-101 Lock cover kit
- AT-104 Dial stop pins
- AT-504 Plaster hole cover kit (small)
- AT-505 Surface mounting base
- AT-546 Auxiliary mounting plate
- AT-602 Selector switch sub-base DP4T
- AT-1103 Wire guard
- AT-1104 Cast aluminum guard
- AT-1105 Plastic guard
- AT-1155 Plastic guard
- AT-1165 Plastic guard
- PKG-1093 Digital thermometer battery replacement kit

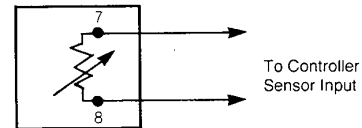

TS-8101 Series

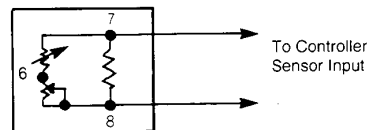

TS-8111 Series

Figure-1 Sensor Wiring.

PRE-INSTALLATION

Inspection

Inspect the carton for damage. If damaged, notify the appropriate carrier immediately. If undamaged, open the carton and inspect the device for obvious damage. Return damaged products.

Required Installation Items

- Wiring diagrams
- Tools (not provided):
DVM (digital volt-ohm meter)
Appropriate screwdriver for mounting screws and terminal connections
- Appropriate accessories
- Mounting screws, two (2) provided for securing to a 2 x 4 conduit box

INSTALLATION

Caution:

- Installer must be a qualified, experienced technician.
- Make all connections in accordance with the wiring diagram, and in accordance with national and local electrical codes. Use copper conductors only.
- Do not exceed ratings of the device.

Mounting

LOCATION

Locate the sensor on a wall where it will be exposed to unrestricted air circulation, at a minimum of 15 ft./min., which represents the average temperature of the sensed space.

Normally, the sensor is located 5-1/2 to 6-1/2 ft. (1.7 to 2.0 m) from floor level.

Caution: Do not locate the sensor near sources of heat or cold, such as lamps, motors, sunlight or concealed ducts or pipes. Avoid location where excessive vibration, moisture, corrosive fumes or vapors are present. NEMA Type 1 covers are intended for indoor use primarily to provide a degree of protection against contact with the enclosed equipment.

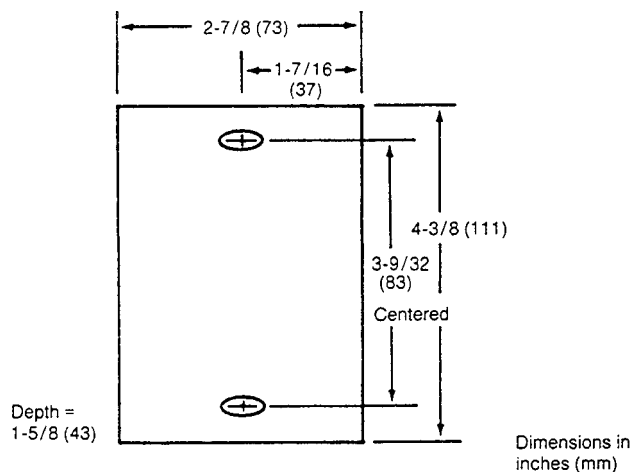

Figure-2 Mounting Dimensions.

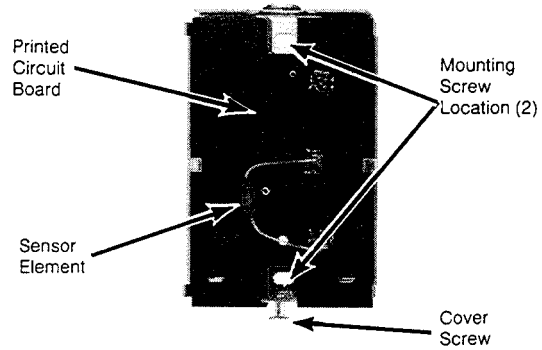

Figure-3 TS-8101 Series Mounting (Cover Removed) and Part Identification.

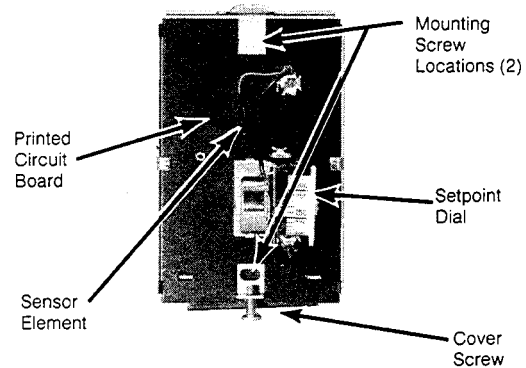

Figure-4 TS-8111 Series Mounting (Cover Removed) and Part Identification.

Wiring

Two conductor twisted pair wires (six turns per foot), Class II, low voltage, are suitable for the sensor leads except as stated below.

Caution: Shielded cable must be used when it is necessary to install the sensor lead in the same conduit with power wiring, or when it is known that high RFI/EMI generating devices are near. System ground the shield at the controller only on the COM (-) terminal or Blue (-) lead. Do not use an earth ground.

Do not use inside of the cover as a junction box for other control circuits.

Restrict element lead to shortest length practical (see Table 2).

Table-2 MAXIMUM SENSOR WIRING RUN.

Wire Gauge	Length of Run in ft. (m)	
	TS-81XX/TS-81XX-770 Sensor to Controller (except TP-810X or "TSP" Transmitter)	TS-8101/TS-8101-770 Sensor to TP-810X
22	150 (46)	125 (38)
18	1000 (305)	300 (91)
16	2250 (686)	-
14	4000 (1219)	-

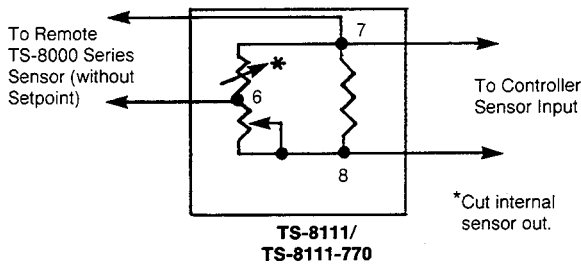

Figure-5 Wiring for TS-8111 Series with Remote Sensor.

ADJUSTMENTS

Turn the control dial knob to required setting on TS-8111 adjustable models. No adjustments are possible on TS-8101.

CHECKOUT

Measure the resistance between terminals 7 and 8 (see Figure 1).

TS-8101 Series: 100 ohms $\pm 0.1\%$ at 70°F (21°C); changes 2.2 ohms per 1°F (0.5°C) at 70°F (21°C).

TS-8111 Series (see Figure 5): 1000 ohms when control dial is set to sensed temperature.

CONCEALED CONTROL DIAL ADJUSTMENT

Knurled Dial Removal

See Figure 6.

1. Remove sensor cover.
2. Secure the control dial with hand so that the dial will not rotate.
3. Place needle nose pliers at knurled ring of the control dial at the points where the knurled ring is attached to the control dial.
4. Twist the pliers at each knurled ring attachment point until the entire knurled ring of the control dial is removed.

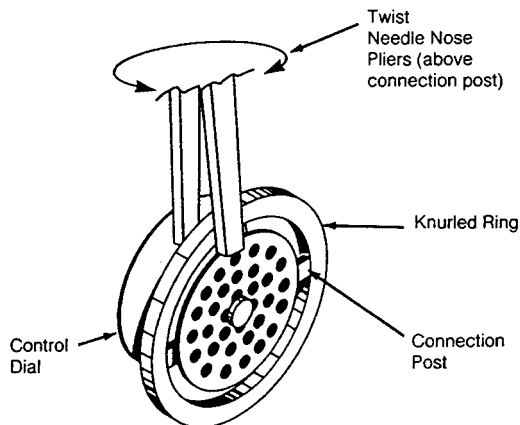

Figure-6 Knurled Dial Removal.

LIMIT CONTROL DIAL RANGE

Dial Stop Pin Insertion - Included with Mounting Plate

See Figure 7.

1. Remove sensor cover.
2. Secure the control dial with hand so that the dial will not rotate.
3. Place a dial stop pin in the jaws of a needle nose pliers.
4. Insert the dial stop pin in the appropriate hole on either (or both) side(s) of the control dial to restrict dial rotation.

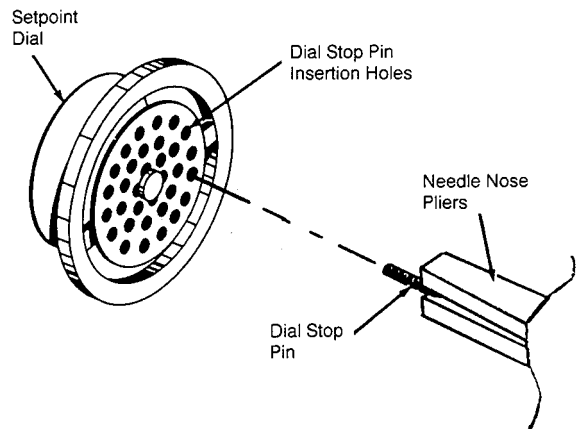

Figure-7 Dial Stop Pin Insertion.

Cover Insert Installation (See Figure 8)

1. Select appropriate cover insert.

Note: If blank insert is used, The knurled ring must be removed from the setpoint dial. See Knurled Dial Removal above. Also, remove dial window by sliding and/or pressing window from front of cover.

2. Remove protective backing and protective skin on face of cover insert.
3. Press insert uniformly on the thermostat with company logo in lower left-hand corner.

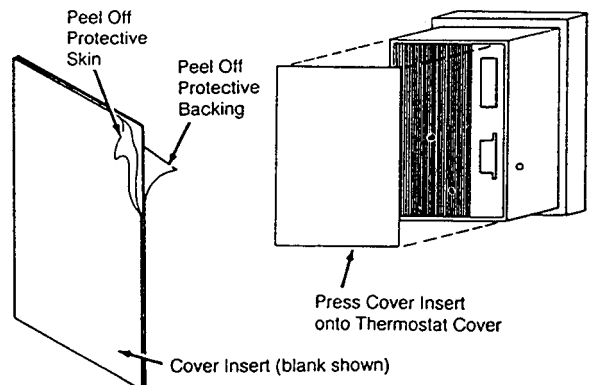

Figure-8 Cover Insert Installation.

MAINTENANCE

Regular maintenance of the total system is needed to assure sustained optimum performance. Sensors should be periodically inspected for dirt or blockage of air over the elements.

FIELD REPAIR

These sensors are not field repairable. Replace a defective sensor with a functional unit.

On October 1st, 2009, TAC became the Buildings business of its parent company Schneider Electric. This document reflects the visual identity of Schneider Electric, however there remains references to TAC as a corporate brand in the body copy. As each document is updated, the body copy will be changed to reflect appropriate corporate brand changes.

Copyright 2010, Schneider Electric
All brand names, trademarks and registered trademarks are the property of their respective owners. Information contained within this document is subject to change without notice.

Schneider Electric
1354 Clifford Avenue
P.O. Box 2940
Loves Park, IL 61132-2940
www.schneider-electric.com/buildings

