



by Schneider Electric

User Manual Easy UPS On-Line SRV1KUXI-IN, SRV2KUXI-IN and SRV3KUXI-IN

Important Safety Instructions

SAVE THESE INSTRUCTIONS - This manual contains important instructions that should be followed during installation and maintenance of the Easy UPS.

Read these instructions carefully and look at the equipment to become familiar with the device before trying to install, operate, service or maintain it. The following special messages may appear throughout this manual or on the equipment to warn of potential hazards or to call attention to information that clarifies or simplifies a procedure.



The addition of either symbol to a “Danger” or “Warning” safety label indicates that an electrical hazard exists which will result in personal injury if the instructions are not followed.



This is the safety alert symbol. It is used to alert you to potential personal injury hazards. Obey all safety messages that follow this symbol to avoid possible injury or death.

DANGER

DANGER indicates a hazardous situation which, if not avoided, **will result in death or serious injury**.

WARNING

WARNING indicates a hazardous situation which, if not avoided, **could result in death or serious injury**.

CAUTION

CAUTION indicates a hazardous situation which, if not avoided, **could result in minor or moderate injury**.

NOTICE

NOTICE is used to address practices not related to physical injury.

Product Handling Guidelines



<18 kg
<40 lb



18-32 kg
40-70 lb



32-55 kg
70-120 lb



>55 kg
>120 lb



Safety and General Information

Inspect the package contents upon receipt. Notify the carrier and dealer if there is any damage.

Read the Safety Guide before installing the UPS.

- This UPS is for indoor use only.
- Do not operate this UPS in direct sunlight, in contact with fluids, or where there is excessive dust or high humidity.
- Do not operate the UPS near open windows or doors.
- Be sure the air vents on the UPS are not blocked. Allow adequate space for proper ventilation.
NOTE: Allow a minimum of 20 cm clearance on both front and rear sides of the Easy UPS.
- Environmental factors impact battery life. Elevated ambient temperatures and poor quality utility power causing frequent discharges will shorten battery life. Follow the battery manufacturer recommendations.

Electrical safety

- When grounding cannot be verified, disconnect the equipment from the utility power outlet before installing or connecting to other equipment. Reconnect the power cord only after all connections are made.
- Connection to the branch circuit (mains) must be performed by a qualified electrician.
- The protective earth conductor for the UPS carries the leakage current from the load devices (computer equipment). An insulated ground conductor is to be installed as part of the branch circuit that supplies input power to the UPS. The conductor must have the same size and insulation material as the grounded and ungrounded branch circuit supply conductors. The conductor will be green and with or without a yellow stripe.
- The grounding conductor is to be grounded to earth at the service equipment, or if supplied by a separately derived system, at the supply transformer or motor generator set.

Battery safety

- Replace batteries with the same number and type of batteries as originally installed in the equipment.
- Over charging, over heating or other misuse of batteries can result in a discharge of battery electrolyte. Released electrolyte is toxic and may be harmful to the skin and eyes.
- Use tool with insulated handles.
- Wear rubber gloves and boots.
- CAUTION: Before installing or replacing the batteries, remove jewelry such as wristwatches and rings. High short circuit current through conductive materials could cause severe burns.
- CAUTION: Do not dispose of batteries in a fire. The batteries may explode.
- CAUTION: Do not open or mutilate batteries. Released material is harmful to the skin and eyes and may be toxic.

Hardwiring safety

- Verify that all branch circuit (mains) and low voltage (control) circuits are de-energized, and locked out before installing cables or making connections, whether in the junction box or to the UPS.
- Wiring by a qualified electrician is required.
- Adhere to national and local codes.
- Select wire size and connectors according to national and local codes.
- All openings allowing access to UPS hardwiring terminals must be covered. Failure to do so may result in personal injury or equipment damage.

Radio Frequency Warning







This is a category C2 UPS product. In a residential environment, this product may cause radio interference, in which case the user may be required to take additional measures.

Product Description

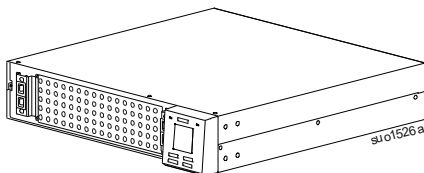
The APC by Schneider Electric Easy UPS is a high performance, uninterruptible power supply (UPS). The Easy UPS helps to provide protection to connected equipment from utility power blackouts, brownouts, sags, surges, small utility fluctuations and large disturbances. The Easy UPS also provides battery backup power to connected equipment until utility power returns to normal levels or the batteries are fully discharged.

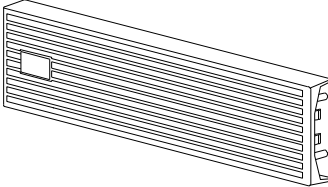
This user manual is available on the enclosed Documentation CD and on the APC by Schneider Electric Web site, www.apc.com.

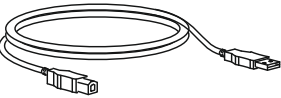
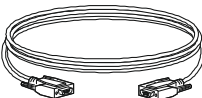
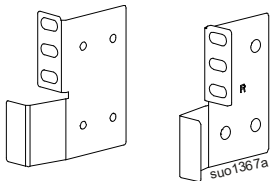
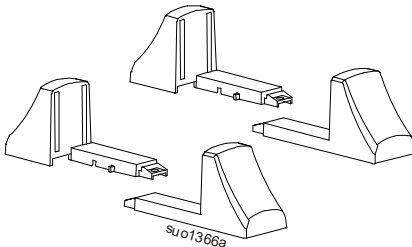
Package Contents

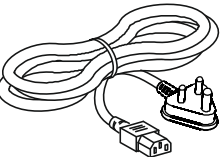
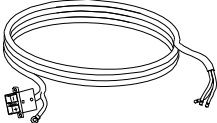
<p>Easy UPS</p>  <p>suo1526a</p>	<p>Software, User documentation CD</p> 
<p>Front bezel</p> 	<p>User documentation</p> 
<p>USB cable</p> 	<p>Serial communication cable</p> 
<p>Rack-mount bracket x1 pair</p>  <p>suo1367a</p>	<p>Stabilizer brackets x2 pairs</p>  <p>suo1366a</p>
<p>Flat head screws x8</p> 	<p>Pan head screws x4</p> 
<p>Utility power cable</p>  <p>NOTE: Supplied with SRV1KUXI-IN model only.</p>	<p>Battery cable</p> 

NOTE:

The model and serial numbers are located on a label in the top panel.

The packaging is recyclable; save it for reuse or dispose of it properly.

Optional Accessories

Refer to the APC by Schneider Electric Web site, www.apc.com, for available accessories.

Specifications

Environmental specifications

NOTICE

RISK OF EQUIPMENT DAMAGE

- Easy UPS must be used indoors only.
- The installation location should be sturdy to withstand the weight of the Easy UPS.
- Do not operate Easy UPS where there is excessive dust or where the temperature or humidity are outside specified limits.

Failure to follow these instructions can result in equipment damage.

		SRV1KUXI-IN	SRV2KUXI-IN	SRV3KUXI-IN
Temperature	Operating	<ul style="list-style-type: none"> • 0 to 40 °C at rated load • 40 to 50 °C linearly derated to 80% of maximum load capacity 		
	Storage	-20 to 60 °C		
Elevation	Operating	<ul style="list-style-type: none"> • 0 to 2,000 m: Normal operation • 2,000 to 3,000 m: The output power reduces @ 1% for increase in height of every 100 m • > 3,000 m: UPS will not work 		
	Storage	0 to 15,000 m		
Humidity		0 to 95% relative humidity, non-condensing		
International Protection Code		IP 20		

Physical specifications

	SRV1KUXI-IN	SRV2KUXI-IN	SRV3KUXI-IN
Dimensions with package Width x Height x Depth	500 x 240 x 550 mm (19.7 x 9.5 x 21.7 in)	545 x 240 x 700 mm (21.5 x 9.45 x 27.6 in)	
Dimensions without package Width x Height x Depth	438 x 86.2 x 332.2 mm (17.2 x 3.4 x 13.1 in)	438 x 86.2 x 462.2 mm (17.2 x 3.4 x 18.2 in)	
Weight with package (approx.)	10.3 kg	13.9 kg	13.7 kg
Weight without package (approx.)	7.2 kg	9.8 kg	10.1 kg

Input specifications

	SRV1KUXI-IN	SRV2KUXI-IN	SRV3KUXI-IN
Nominal input voltage	230 VAC		
Input frequency*	40 - 70 Hz (auto-sensing)		
Input voltage range (100% load)	160 to 280 VAC at 35 °C		
Input voltage range (50% load)	110 to 280 VAC		
Input power factor (100% resistive load at nominal voltage)	≥ 0.95		
Input protection	Circuit breaker		

*NOTE: Refer to product specifications for derating in frequency converter mode.

Output specifications

	SRV1KUXI-IN	SRV2KUXI-IN	SRV3KUXI-IN
Easy UPS Capacity	1000 VA / 800 W	2000 VA / 1600 W	3000 VA / 2400 W
Nominal output voltage	230 VAC		
Other programmable voltage	220 VAC, 240 VAC		
Efficiency at rated load	≥ 88%		≥ 90%
Output voltage regulation	±1% static		
Output voltage distortion	<ul style="list-style-type: none"> • 3% max. for full linear load • 6% max. for full non linear load (100% VA, 0.8 PF) • 15% for the last 60 seconds of the backup time 		
Frequency - On battery	50 Hz ± 0.5 Hz / 60 Hz ± 0.5 Hz		
Frequency - AC mode	50 Hz ± 3 Hz / 60 Hz ± 3 Hz		
Crest factor	3:1		
Waveform	Sinewave		
Output connection	Refer "Rear Panel Features" on page 13 for details.		
Bypass	Internal Lower setting: 161/173/184/196 VAC Upper setting: 242/253/265/276 VAC		

Battery bank

CAUTION

RISK OF HYDROGEN SULPHIDE GAS AND EXCESSIVE SMOKE

- Replace the battery at least every 5 years or at the end of its service life, whichever is earlier.
- Replace the battery immediately when the UPS indicates battery replacement is necessary.
- Replace batteries with the same number and type of batteries as originally installed in the equipment.
- Replace the battery immediately when the UPS indicates a battery over-temperature condition, or when there is evidence of electrolyte leakage. Power off the Easy UPS, unplug it from the AC input, and disconnect the batteries. Do not operate the Easy UPS until the batteries have been replaced.

Failure to follow these instructions can result in minor or moderate injury and equipment damage.

	SRV1KUXI-IN	SRV2KUXI-IN	SRV3KUXI-IN
Configuration	External battery		
Type	Sealed maintenance free valve regulated lead acid type (SMF)/ Tubular (TUB) type		
Battery bank voltage	24 VDC	72 VDC	

Tower Installation

⚠ CAUTION

RISK OF FALLING EQUIPMENT

- The Easy UPS is heavy.
- Always practice safe lifting techniques adequate for the weight of the equipment.
- Do not lift the Easy UPS by holding the front panel display.
- Ensure that the stabilizer brackets are installed along with the Easy UPS in tower orientation.

Failure to follow these instructions can result in minor or moderate injury and equipment damage.

Front panel display rotation

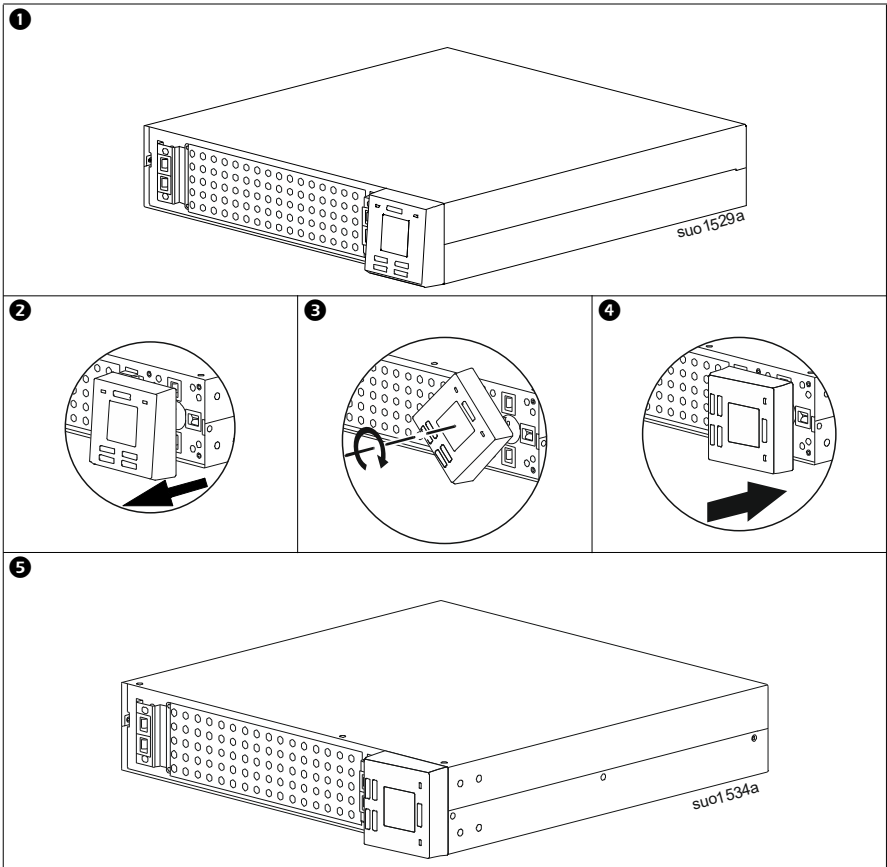

Installing stabilizer brackets

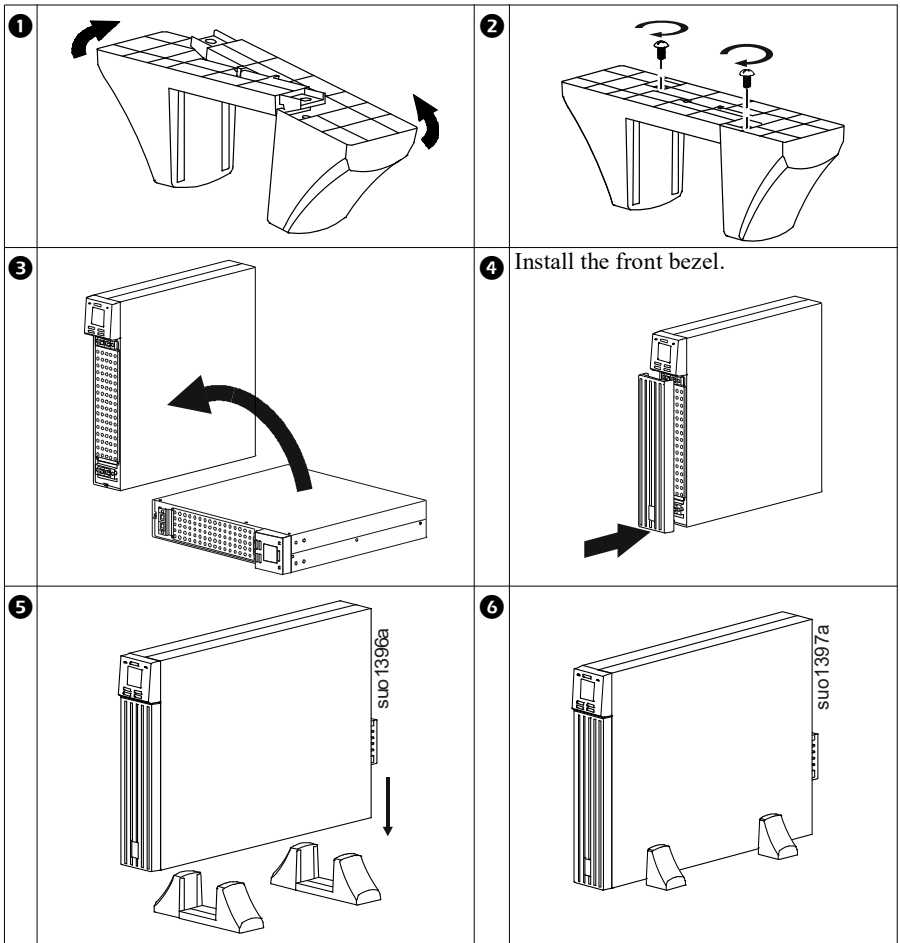

NOTE: Maintain approximately 35 mm distance from the edge of the unit, when installing the stabilizer brackets to the Easy UPS.

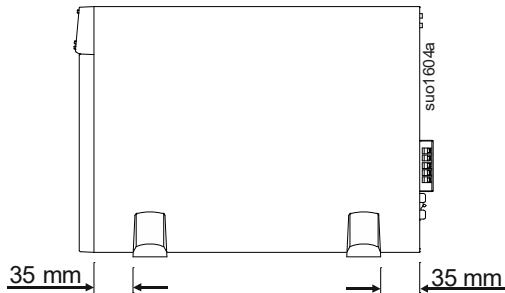

Rack-Mount Installation

⚠ CAUTION

RISK OF FALLING EQUIPMENT

- The Easy UPS is heavy.
- Always practice safe lifting techniques adequate for the weight of the equipment.
- Do not lift the Easy UPS by holding the front panel display.
- Always install the UPS at the bottom of the rack.
- Always use the recommended number of screws to secure brackets to the UPS.
- Given the heavy weight, the use of rack-mount brackets is mandatory during rack installation (guide with L-shaped support).
- Secure the unit in the rack using all the screws supplied for the purpose.

Failure to follow these instructions can result in minor or moderate injury and equipment damage.

Optional Rail Kit accessories SRVRK1 to enable the installation of Easy UPS in rack-mount configuration is available for purchase.

- 1 Install the rack-mount brackets.

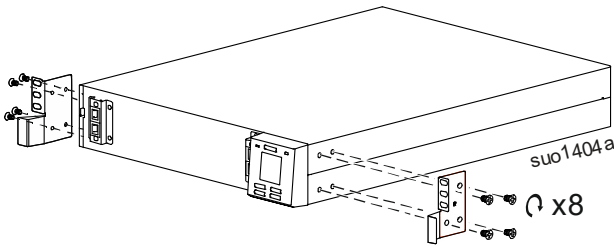

- 2** Lift the Easy UPS module and slide it into rack enclosure.

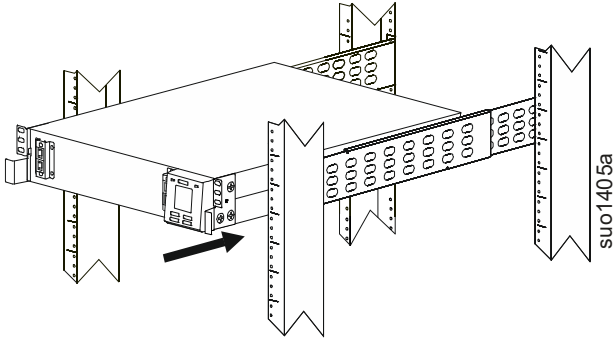

- 3** Secure the Easy UPS module to the rack with screws, nuts and washers (not supplied in the package).

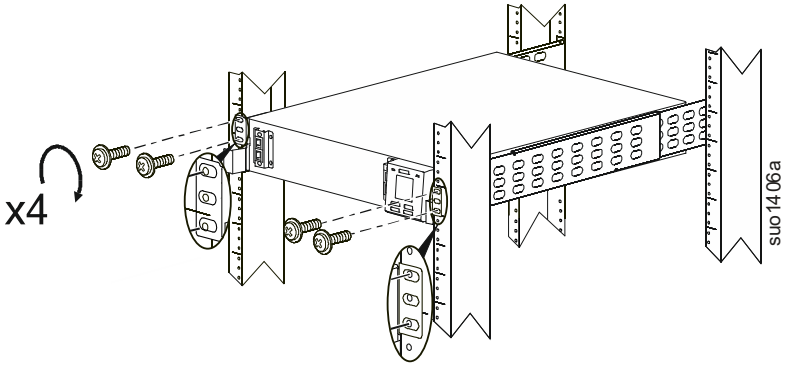

- 4** Install the front bezel.

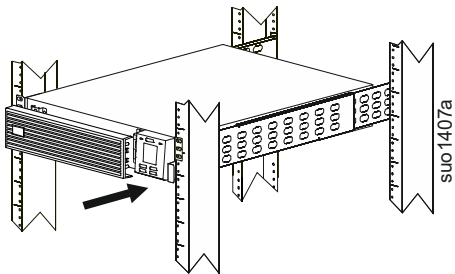

Rear Panel Features

SRV1KUXI-IN

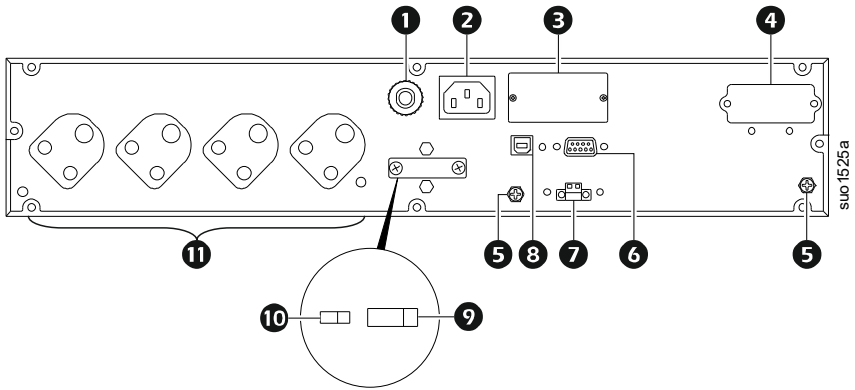

SRV2KUXI-IN and SRV3KUXI-IN

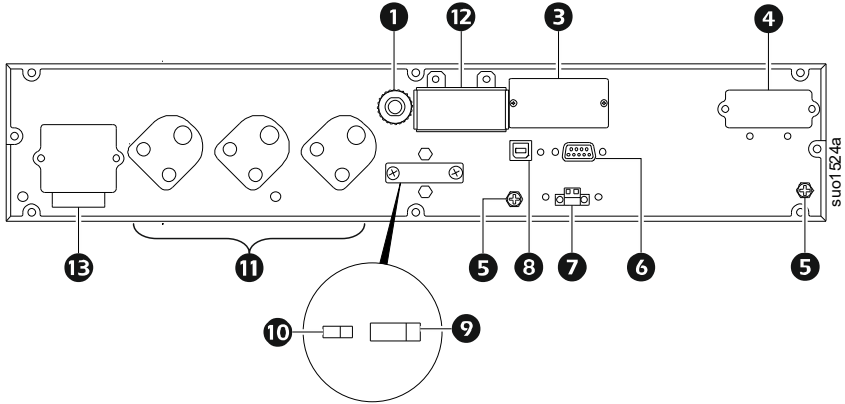

Actual UPS may differ in appearance from the illustration.

1 Input circuit breaker	8 USB port
2 Utility power connector	9 Battery charging current selector switch
3 Intelligent slot for management accessories	10 Battery type selector switch
4 Battery connector	11 Battery backup outlets
5 Ground screw	12 Input terminal block
6 Serial communication port	13 Output terminal block
7 Emergency power off (EPO) connector	

Hardwiring - SRV2KUXI-IN and SRV3KUXI-IN

⚠ CAUTION

RISK OF ELECTRIC SHOCK

- Adhere to all national and local electrical codes.
- All electrical work must be performed by a qualified electrician.
- Turn off all power to this equipment before working on the equipment.
- Switch the external circuit breaker off. Practice lockout/tagout procedures.
- Do not wear jewelry when working with electrical equipment.
- Select wire size and connectors according to national and local codes.

Failure to follow these instructions can result in moderate injury.

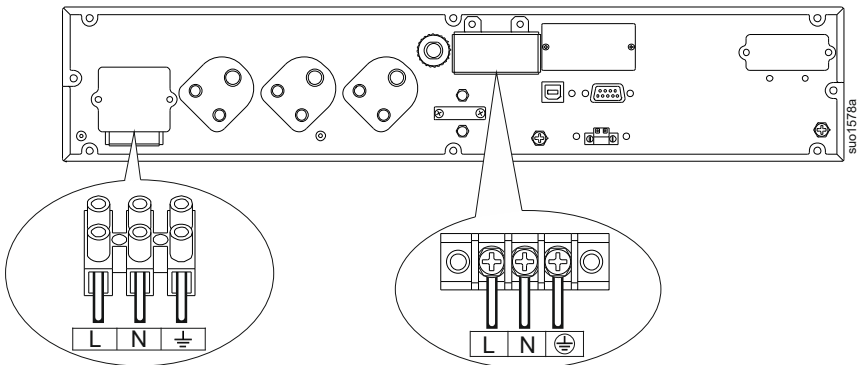

Input hardwiring

- Use 12 AWG (4 mm²) wire (not supplied) for hardwiring the input.
1. Locate the cover of the input hardwire terminal block on the rear panel.
 2. Remove the screws securing the cover and remove the cover.
 3. Connect the line, neutral and earth/ground wires to the terminal block. Terminals are labeled for proper wire configuration.
 4. Replace and secure the cover using the screws removed in *step 2*.

Output hardwiring

- Use 12 AWG (4 mm²) wire (not supplied) for hardwiring the output.
1. Locate the cover of the 16 A output hardwire terminal block on the rear panel.
 2. Remove the screws securing the cover and remove the cover.
 3. Connect the line, neutral and ground wires to the terminal block. Terminals are labeled for proper wire configuration.
 4. Replace and secure the cover using the screws removed in *step 2*.

Connect the Battery Bank to Easy UPS

CAUTION

RISK OF ELECTRIC SHOCK

- Adhere to all national and local electrical codes.
- All electrical work must be performed by a qualified electrician.
- Identify the polarities of the battery terminals before connecting the battery. Be sure grounding is connected firmly.
- Do not short the battery terminals.
- Do not touch multiple terminals in the battery at the same time.
- Do not wear jewelry when working with electrical equipment.

Failure to follow these instructions can result in moderate injury.

NOTICE

RISK OF IMPROPER CONNECTION

Connect the battery according to the battery voltage indicated on the rear panel. If the connected battery voltage is incorrect, UPS may be damaged and cannot be repaired. Therefore, be sure to confirm that the battery voltage is in accordance with the UPS specification.

Failure to follow these instructions can result in equipment damage.

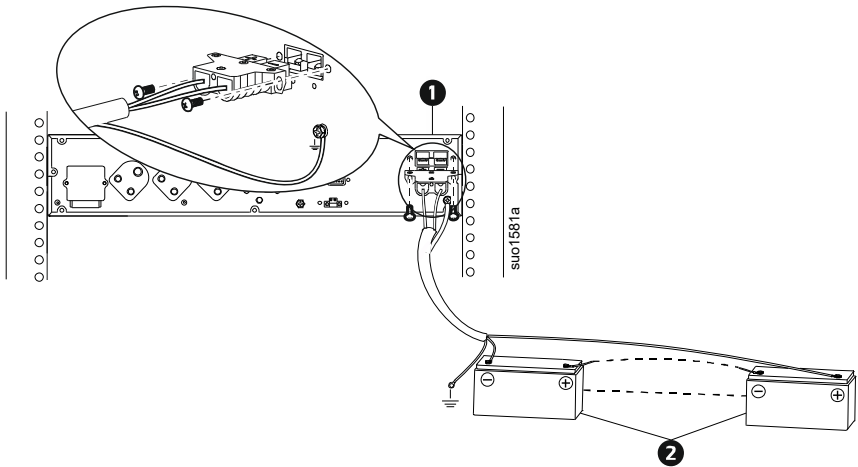

1	Easy UPS
2	Battery

NOTE: The illustration is shown for SRV2KUXI-IN and SRV3KUXI-IN Easy UPS. Follow the same procedure to connect the battery to SRV1KUXI-IN Easy UPS.

1. Locate the battery connector cover on rear panel of Easy UPS.
2. Remove the screws securing the cover and remove the cover.
3. Use the supplied battery connection cable.
4. Crimp the appropriate size lugs suitable for the battery to each end of the loose wires of the battery connection cable.
5. Connect the lugs of the positive (red) and negative (black) wires, to the positive and negative terminals respectively, on the battery bank.
NOTE: Connect the ground wire of the battery connection cable to the to the metal frame housing the batteries.
 If a metal frame is not used for housing the batteries, then be sure to properly insulate this ground wire.
6. Plug the battery cable connector into the battery connector receptacle on the rear side of the UPS.
7. Insert and tighten the screws removed in *step 2* to secure the battery connector receptacle to the battery connector of Easy UPS.
8. Connect the ground wire at the battery cable connector end to the ground terminal in the Easy UPS.

Start Up

Connect equipment and input power to the Easy UPS

CAUTION

RISK OF ELECTRIC SHOCK

- All electrical work must be performed by a qualified electrician.
- Turn off all power to this equipment before working on the equipment.
- Practice lockout/tagout procedures.
- Do not wear jewelry when working with electrical equipment.

Failure to follow these instructions can result in moderate injury.

1. Connect equipment to SRV1KUXI-IN Easy UPS. Refer “Rear Panel Features” on page 13 for details.
Connect equipment either to the 6 A outlets or to the 16 A hardwire terminal block in SRV2KUXI-IN and SRV3KUXI-IN Easy UPS. For connecting equipment to the 16 A hardwire terminal block refer “Output hardwiring” on page 15 for details.
2. Connect battery bank to the Easy UPS. Refer “Connect the Battery Bank to Easy UPS” on page 15 for details.
3. Set the battery type using the battery type selector switch on the rear panel. Refer “Battery type and Charger current selection” on page 24 for details.
4. Set the charger current for the batteries connected to the Easy UPS. Refer “Battery type and Charger current selection” on page 24 for details.
5. Connect input utility power to the Easy UPS.
For SRV1KUXI-IN connect input utility power cable to the utility power connector.
For SRV2KUXI-IN and SRV3KUXI-IN refer “Input hardwiring” on page 14 for details.
6. Switch on the input utility power. The Easy UPS display panel will illuminate.

Start the Easy UPS

Press and hold the POWER ON/OFF button located on the front panel of Easy UPS until a beep is heard. The **Status** LED will illuminate green.

- Be sure to charge the battery to its full capacity initially.
- **Do not** expect full backup time during this initial charge period.

Cold start the Easy UPS

Use cold start feature to supply power to connected equipment from the batteries.

Press and hold the POWER ON/OFF button located on the front panel of Easy UPS until a beep is heard. The display panel will illuminate.

Press the POWER ON/OFF button again to supply battery power to the connected equipment.

Turn off Easy UPS

To turn off the Easy UPS, press and hold the POWER ON/OFF button on the front panel display until a beep is heard.

Connect and install management software

Easy UPS is provided with SchneiderUPS management software for unattended operating system shutdown, monitoring, control and energy reporting. The following diagram is a representation of a typical server installation.

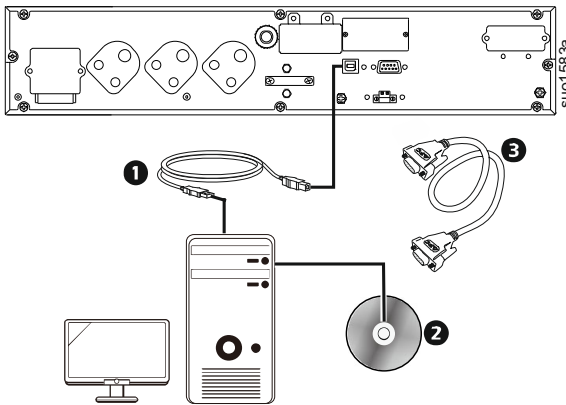

1	Connect the USB cable from the rear of the Easy UPS to the computer.
2	Load the SchneiderUPS CD and follow the on-screen set-up instructions.
3	A built-in serial port is also available for additional communication options with serial cable.

Additional communication options are available via the built-in intelligent slot. Refer to APC by Schneider Electric Web site, www.apc.com for more information.

Emergency Power Off

NOTICE

RISK OF EQUIPMENT DAMAGE

- Adhere to all national and local electrical codes.
- All electrical work must be performed by a qualified electrician.
- Do not connect the EPO interface to any circuit other than an unused circuit.

Failure to follow these instructions can result in equipment damage.

The Emergency Power Off (EPO) function is a feature that will immediately remove power to all connected equipment.

The EPO switch is internally powered by the Easy UPS for use with non-powered switches or potential free normally closed (N/C) contacts.

Connecting normally closed (N/C) contacts

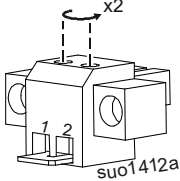
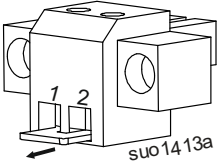
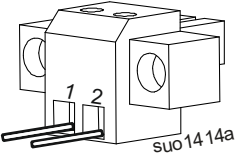
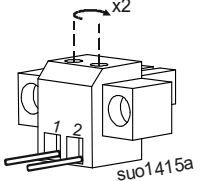
<p>1 Loosen the screws of terminals 1 and 2 in the EPO connector.</p> 	<p>2 Remove the metal link between pins 1 and 2.</p> 
<p>3 Connect N/C relay contacts between pins 1 and 2 of the EPO terminal block. Use 0.5 to 1 mm² wire.</p> 	<p>4 Secure the EPO connector screws beneath pins 1 and 2.</p> 

NOTE: If the N/C contact is open, the Easy UPS will turn off. Power to the connected equipment will be immediately turned off.

The EPO interface is a Safety Extra Low Voltage (SELV) circuit. Connect it only to other SELV circuits. The EPO interface monitors circuits that have no determined voltage potential. Such closure circuits may be provided by a switch or relay properly isolated from the utility. To avoid damage to the Easy UPS, do not connect the EPO interface to any circuit other than an unused circuit.

Use one of the following cable types to connect the Easy UPS to the EPO switch.

- CL2: Class 2 cable for general use.
- CL2P: Plenum cable for use in ducts, plenums, and other spaces used for environmental air.
- CL2R: Riser cable for use in a vertical run in a floor-to-floor shaft.

Operation

Front panel display features



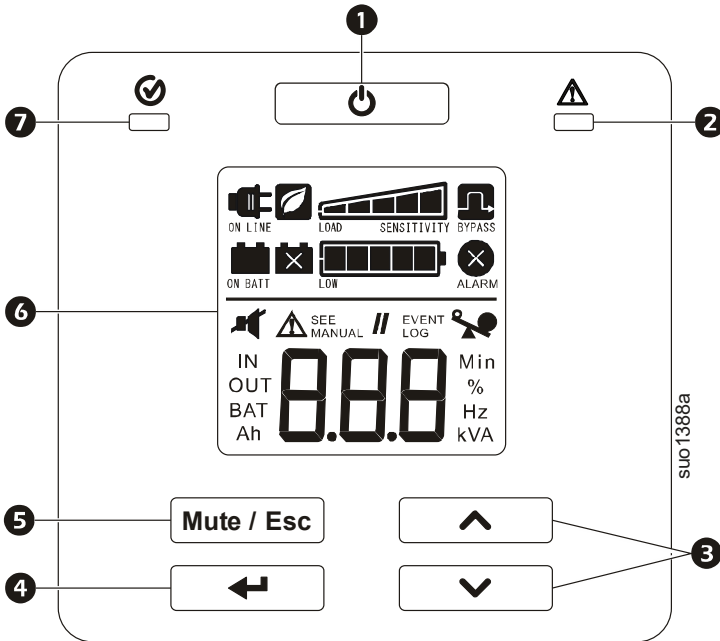







Easy UPS models are equipped with an intuitive and configurable LCD display. The display complements the software interface as they convey similar information and either may be used to configure the Easy UPS settings.



1	POWER ON/OFF button	Press the POWER ON/OFF button to turn on the Easy UPS. Press and hold the POWER ON/OFF button until a beep is heard to turn off the Easy UPS. Press the POWER ON/OFF button to reset alerts.
2	Alert LED	The Alert LED illuminates red when the Easy UPS detects an internal error and blinks red for Easy UPS notifications. Refer “Alerts and Notifications” on page 30 for details.
3	UP/DOWN ARROW button	Press the UP/DOWN ARROW button to scroll through the main menu options and display screens.
4	ENTER button	Press the ENTER button to enter the menu or to select a menu item/value during navigation.
5	MUTE/ESC button	Press the MUTE/ESC button: <ul style="list-style-type: none"> To acknowledge audible alerts and suppress them temporarily. To exit a sub menu and return to the main menu.

6	LCD Display	The display interface options are visible on this LCD screen. Press any button to activate LCD, if the display is not illuminated.
7	Status LED	<p>The Status LED illuminates green when the power is on. The LED indicates two different states of output power:</p> <ul style="list-style-type: none"> • Output off: LED blinks on and off. Press POWER ON/OFF button to turn the output power on. • Output on: LED illuminates green continuously.

Front panel display icons

	<p>On Line: The Easy UPS is drawing utility power and performing double conversion to supply power to the connected equipment.</p>
	<p>On Battery: The Easy UPS is supplying battery backup power to the connected equipment.</p>
	<p>Replace Battery: The battery is not connected securely or the battery is nearing the end of its service life and should be replaced.</p>
	<p>Bypass: The Easy UPS is in bypass mode, sending utility power directly to connected equipment. Bypass mode operation is the result of an internal UPS event, an overload condition, or a user initiated command either through the display interface or through an accessory. Battery operation is not available while the Easy UPS is in bypass mode. Refer “Alerts and Notifications” on page 30 for details.</p>
	<p>System Alerts: The Easy UPS has detected an internal error. See “Alerts and Notifications” on page 30 in this manual.</p>
	<p>Overload: The equipment connected to the Easy UPS is drawing more power than rated.</p>
	<p>Battery Charge: The battery charge level is indicated by the number of bar sections illuminated. When all five blocks are illuminated, the battery is fully charged. Each bar represents approximately 20% of the battery charge capacity.</p>
	<p>Load Level: The load percentage is indicated by the number of load bar sections illuminated. Each bar represents approximately 20% of the load.</p>
	<p>Mute: An illuminated line through the icon indicates that the audible alert is disabled.</p>
	<p>Green Mode: An illuminated icon indicates that the unit is working in Green mode. The connected equipment is receiving the utility input directly as long as the input voltage and frequency are within the configured limits.</p>

 SEE MANUAL	Alert or notification: The Easy UPS has detected an internal error or the Easy UPS is in configuration mode. Refer “Alerts and Notifications” on page 30 for details.
EVENT LOG	Event: The icon is illuminated when the user is viewing the event log.

Status Indicators

Audible Alert	Condition
Continuous beeps, every half second	Low Battery State - The battery is nearing its discharge state. The Easy UPS is about to shutdown. Overload condition - The equipment connected to the Easy UPS is drawing more power than rated.
4 beeps every 30 sec (first beep starts after 4 sec on battery)	On Battery State - The Easy UPS is supplying battery backup power to the connected equipment.
Continuous beeps	Alert State - Easy UPS has detected an internal error. Refer “Alerts and Notifications” on page 30 for details.
Short beep every 2.5 sec	Battery disconnected.
Continuous short beeps for every half second for 1 minute, repeats every 5 hours	Replace battery.
Two short beeps every 5 sec	Event Bypass State - Easy UPS has detected an internal error. Connected equipment receives utility input power through the bypass relay.

Easy UPS Display Parameters

Operational data displayed in the display panel is given in the table. Navigate using the UP/DOWN ARROW buttons.

Parameter	Units	Indicator Icons
Output voltage	VAC	OUT, V
Output frequency	Hz	OUT, Hz
Input voltage	VAC	IN, V
Input frequency	Hz	IN, Hz
State of battery charge	%	BAT, %
Battery voltage	VDC	BAT, V
Ambient temperature	°C	NUMBER, C
Remaining On Battery runtime	Minutes	BAT, Min
Load level in percentage (Maximum of Watts or VA)	%	OUT, %
Load level in kVA	kVA	OUT, kVA
Total Ah capacity of connected battery	Ah	BAT, Ah

Configuration

Battery type and Charger current selection

1. Locate the cover of the battery type and charging current selector switches on the rear panel. Refer “Rear Panel Features” on page 13 for details.
2. Remove the screws securing the cover and remove the cover.
3. Set the type of battery through the battery type selector switch.
4. Set the charger current through the charger current selector switch.
5. Replace and secure the cover removed in *step 2*.

WARNING

RISK OF FIRE

Select the correct charger current for the batteries connected to the Easy UPS.

Failure to follow this instruction could result in death or serious injury.

Charging current	1 A	2 A	4 A	8 A
SMF battery capacity	7 Ah to 10 Ah	12 Ah to 20 Ah	26 Ah to 42 Ah	> 65 Ah
Tubular battery capacity			40 Ah	> 60 Ah

Easy UPS settings

Configure Easy UPS settings using the display interface. Refer “Configure Easy UPS parameters” on page 27 to edit the parameters.

Function	Factory Default	User Selectable Options	Description
Output voltage	230 VAC	220, 230, 240 VAC	Allows the user to select output voltage while the Easy UPS is in standby mode.
Audible alert	🔊 (Enable)	🔊 (Enable) 🔇 (Disable)	Easy UPS will mute audible alerts when set to disable or when the display panel buttons are pressed.

Function	Factory Default	User Selectable Options	Description
Green mode/ high efficiency mode	☐ (Disable)	☑ (Enable) ☐ (Disable)	When this mode is enabled, connected equipment receives utility input power through the bypass relay as long as input voltage is within the range of $\pm 5\%$ of configured output voltage and ± 3 Hz of configured output frequency. Inverter is turned off during this mode. If utility power input goes out of range, inverter is turned on and the load is transferred to online mode or battery mode. The power to the connected equipment may be interrupted up to 10 milliseconds.
Battery Ah capacity	7 Ah	7 to 200 Ah	Allows the user to set the Total Ah of the batteries connected to the Easy UPS.
Minimum battery capacity to restart setting	0%	0%, 15%, 50%, 90%	Easy UPS output will not be turned on until the battery is charged to a level such that it can provide the runtime configured by this setting. If configured to 0%, Easy UPS output is turned on immediately after utility power returns.
Low battery state indication setting	2 min	2 min, 5 min, 7 min, 10 min	The Easy UPS will emit an audible alarm when the remaining run time reaches the limit set by the user when the Easy UPS is in battery mode. Audible alarm will continue in online mode till the run time of the Easy UPS reaches the set limit.
Bypass setting			
Lower voltage	184 VAC	161, 173, 196 VAC	Allows the user to set the upper and lower voltage settings for Bypass.
Upper voltage	276 VAC	253, 242, 265 VAC	

Advanced Display Navigation

The Easy UPS display has five menu options in the main menu options. Press the ENTER button from the Home Screen to access these menu options. Use the UP/DOWN ARROW buttons to navigate between the menu options.

Menu option	Description
<p>SEt</p>	<p>Configure the Easy UPS Use this menu option to configure the Easy UPS parameters. Press the ENTER button to see the configuration options. Refer “Configure Easy UPS parameters” on page 27 for details. Press the MUTE/ESC button to return to the Home Screen.</p>
<p>LOG</p>	<p>Show Event Log Use this menu option to see the Easy UPS event log. The Easy UPS records the last 10 events and displays the codes in this log. Press the ENTER button to see the log. Use the UP/DOWN ARROW buttons to see the logged events. The UP ARROW button navigates towards old events and the DOWN ARROW button navigates to new events. Every log entry has a numeric and textual event code. At the end of the log, the word “End” will be displayed. Press the MUTE/ESC button to return to the Home Screen.</p>
<p>UPS</p>	<p>Show Easy UPS information Use this menu option to see the Easy UPS information. Press the ENTER button to see the rating of the Easy UPS. Press the UP ARROW button to see the Easy UPS firmware version. Press the MUTE/ESC button to return to the Home Screen.</p>
<p>bYP</p>	<p>User Command to bypass Use this menu option to switch the Easy UPS to bypass mode or bring the Easy UPS to online mode from bypass mode. Press ENTER button:</p> <p>Put Put: Use to switch the Easy UPS to bypass mode of operation.</p> <p>NOTE: Power to the connected equipment will drop, if the mains voltage is not within the threshold limits.</p> <p>Out Out: Bring the Easy UPS out of bypass and restore clean power to the connected equipment.</p> <p>The Easy UPS will start a count down on the display while switching to Bypass mode or coming out of Bypass mode.</p>

Menu option	Description
Est	<p>Execute Battery Self Test Use this menu option to conduct a self test and determine the battery status. Press the ENTER button to initiate the test. If the test command is accepted, the Easy UPS will initiate a self test and will start a count down on the display. Display messages are shown at the end of the test.</p> <p>rFd Test refused. The output is off or battery is not charged or battery is disconnected.</p> <p>FLd Test not passed.</p> <p>PA5 Test passed.</p> <p>Abt Test is aborted due to internal reasons.</p> <p>Press the MUTE/ESC button to return to the Home Screen.</p>

Configure Easy UPS parameters

Follow the steps to configure parameters in the Easy UPS:

1. Press the ENTER button.
2. Press the UP/DOWN ARROW buttons to navigate to “Set”.
3. Press the ENTER button.
4. Navigate through the parameters using the UP/DOWN ARROW buttons.
5. Press the ENTER button to edit a parameter. Icons start flashing to indicate the editing.
6. Press the UP/DOWN ARROW buttons to navigate between the options available for the selected parameter.
7. Press the ENTER button to select the option or MUTE/ESC button to abort the editing of current parameter. Flashing of icons stops after this.
8. Press the UP/DOWN ARROW buttons to navigate between parameters.
9. Press the MUTE/ESC button to exit menu navigation.

Troubleshooting

Use the table below to solve minor installation and operation problems. Refer to the APC by Schneider Electric Web site, www.apc.com for assistance with complex Easy UPS problems.

Problem and/or Possible Cause	Solution
Easy UPS will not turn On when utility input is available	
The Easy UPS is not turned on.	Press the POWER button to turn on the Easy UPS.
The Easy UPS is not connected to utility power supply.	Check that the power cable from the Easy UPS to the utility power supply is securely connected at both ends.
Input circuit breaker on the Easy UPS is tripped.	Press the input thermal circuit breaker RESET button in the rear panel.
The Easy UPS is operating on battery, while connected to the input utility power	
Input voltage and frequency are beyond specifications.	Connect the UPS to a different outlet on a different circuit. Test the utility input power to ensure the unit is receiving input power. If display is on, navigate and check the input voltage and frequency.
Easy UPS, when connected to battery, is not supplying power to the connected equipment	
The Easy UPS is not turned on.	If the Easy UPS has shutdown (the display is not on), follow the “Cold start the Easy UPS” on page 18 for procedure.
The battery is not connected.	Connect battery to the Easy UPS. Refer “Connect the Battery Bank to Easy UPS” on page 15 for details.
Low battery cut off. Easy UPS may have discharged the battery due to utility power outage and turned the output off due to low battery condition.	Wait for the utility power to return and charge the battery.
Easy UPS emits an audible beeping sound at long intervals	
The Easy UPS is operating normally when running on battery.	The Easy UPS is operating on battery. See the status of the Easy UPS in the display panel.
Alert LED is illuminated. The Easy UPS displays an alert message and emits a constant beeping sound	
The Easy UPS has detected an internal error.	Refer “Alerts and Notifications” on page 30 for details.
No audible sounds from Easy UPS even when the Alert LED is illuminated	
Audible alert is disabled.	Change the Easy UPS configuration to enable audible alerts.

Problem and/or Possible Cause	Solution
Easy UPS is not providing expected backup time	
Battery is not charged properly.	Be sure that the battery is charged to its full capacity.
Charger taking more time to charge battery.	<ul style="list-style-type: none"> • Be sure that the correct charging current is selected using the charging selector switch. • Input voltage is low to charge the battery with full current.
The battery is near the end of its service life.	If the battery is near the end of its service life, consider replacing the battery, even if the replace battery indicator is not illuminated.
Easy UPS is not turning off	
POWER OFF button not pressed properly.	Press and hold the POWER OFF button until the beep is heard to power off the Easy UPS.
Easy UPS is in Bypass mode and the LED is not illuminated red	
Easy UPS is configured to stay in the bypass mode.	Change the configuration to exit bypass mode.
Easy UPS is in Bypass mode and the LED is illuminated red	
Easy UPS is in bypass mode even after over temperature alarm is cleared.	Wait for some time for the Easy UPS to come back to online mode.
The Easy UPS has experienced an overload condition and transferred to bypass.	<p>Connected equipment exceeds the maximum load as defined in specifications.</p> <p>The alerts remain on until the overload condition is corrected. Disconnect nonessential equipment from the Easy UPS to eliminate the overload condition.</p> <p>The Easy UPS continues to supply power as long as it is in bypass mode and the circuit breaker does not trip. The Easy UPS will not provide battery power in the event of an utility voltage interruption.</p>
Easy UPS detected an internal error and transferred to bypass.	Refer “Alerts and Notifications” on page 30 for details.

Alerts and Notifications

Easy UPS displays a text code and a numeric code on the display when it detects an internal error.

Alerts

Display code	Description	Solution
SC	Easy UPS has experienced a short circuit at the output.	Check if there is any short circuit at the Easy UPS output. Remove the short circuit and press POWER ON/OFF button to start the Easy UPS.
OL	Easy UPS is experiencing an overload condition.	Disconnect nonessential equipment from the Easy UPS to eliminate the overload condition. Wait for the Easy UPS to auto-recover.
dCH dCF	The Easy UPS has detected a DC voltage error. Unit will try to auto-recover from this condition.	If the Easy UPS does not recover automatically, contact APC by Schneider Electric.
HOT	Temperature of the unit is rising above the set limits.	Disconnect non-essential equipment from the Easy UPS to reduce the Easy UPS load. Ensure that ambient temperature is within limits. Ensure that adequate clearance is maintained.
CH9	Easy UPS has detected a charger error.	Press POWER ON/OFF button to start the Easy UPS. If the error is detected again contact APC by Schneider Electric Customer Support.
Contact APC by Schneider Electric for all other alert codes.		

Notifications

Display code	Description	Solution
bdc	Battery is not connected.	Connect battery to the Easy UPS. Refer “Connect the Battery Bank to Easy UPS” on page 15 for details.

Service

If the unit requires service, do not return it to the dealer. Follow these steps:

1. Review the *Troubleshooting* section of the manual to eliminate common problems.
2. If the problem persists, contact APC by Schneider Electric Customer Support.
 - a. Note the model number and serial number and the date of purchase. The model and serial numbers are located on a label in the top panel of the unit.
 - b. Call APC by Schneider Electric Customer Support and a technician will attempt to solve the problem over the phone. If this is not possible, the technician will issue a Service Request Number.
 - c. If the unit is under warranty, the repairs are free.

An Authorized Service Representative will visit your location and try to resolve the issue.

Limited Factory Warranty

Schneider Electric IT Business India Private Ltd. (SEITBIPL), warrants its products to be free from defects in materials and workmanship for a period of two (2) years from the date of purchase. The SEITBIPL obligation under this warranty is limited to repairing or replacing, at its own sole option, any such defective products or parts there of. Repair or replacement of a defective product or part thereof does not extend the original warranty period.

This warranty applies only to the original purchaser who must have properly registered the product within 10 days of purchase. Products may be registered online at warranty.apc.com or by mailing in the completed warranty registration card that is included with the documentation.

SEITBIPL shall not be liable under the warranty if its testing and examination disclose that the alleged defect in the product does not exist or was caused by end user or any third person misuse, negligence, improper installation, testing, operation or use of the product contrary to SEITBIPL recommendations or specifications. Further, SEITBIPL shall not be liable for defects resulting from: 1) unauthorized attempts to repair or modify the product, 2) incorrect or inadequate electrical voltage or connection, 3) inappropriate on site operation conditions, 4) Acts of God, 5) exposure to the elements, 6) theft. In no event shall SEITBIPL have any liability under this warranty for any product where the serial number has been altered, defaced, or removed, 7) normal wear resulting from frequent use.

EXCEPT AS SET FORTH ABOVE, THERE ARE NO WARRANTIES, EXPRESS OR IMPLIED, BY OPERATION OF LAW OR OTHERWISE, APPLICABLE TO PRODUCTS SOLD, SERVICED OR FURNISHED UNDER THIS AGREEMENT OR IN CONNECTION HEREWITH.

SEITBIPL DISCLAIMS ALL IMPLIED WARRANTIES OF MERCHANTABILITY, SATISFACTION AND FITNESS FOR A PARTICULAR PURPOSE.

SEITBIPL EXPRESS WARRANTIES WILL NOT BE ENLARGED, DIMINISHED, OR AFFECTED BY AND NO OBLIGATION OR LIABILITY WILL ARISE OUT OF, SEITBIPL RENDERING OF TECHNICAL OR OTHER ADVICE OR SERVICE IN CONNECTION WITH THE PRODUCTS.

THE FOREGOING WARRANTIES AND REMEDIES ARE EXCLUSIVE AND IN LIEU OF ALL OTHER WARRANTIES AND REMEDIES. THE WARRANTIES SET FORTH ABOVE CONSTITUTE SEITBIPL'S SOLE LIABILITY AND PURCHASER'S EXCLUSIVE REMEDY FOR ANY BREACH OF SUCH WARRANTIES. SEITBIPL WARRANTIES EXTEND ONLY TO ORIGINAL PURCHASER AND ARE NOT EXTENDED TO ANY THIRD PARTIES.

IN NO EVENT SHALL SEITBIPL, ITS OFFICERS, DIRECTORS, AFFILIATES OR EMPLOYEES BE LIABLE FOR ANY FORM OF INDIRECT, SPECIAL, CONSEQUENTIAL OR PUNITIVE DAMAGES, ARISING OUT OF THE USE, SERVICE OR INSTALLATION OF THE PRODUCTS, WHETHER SUCH DAMAGES ARISE IN CONTRACT OR TORT, IRRESPECTIVE OF FAULT, NEGLIGENCE OR STRICT LIABILITY OR WHETHER SEITBIPL HAS BEEN ADVISED IN ADVANCE OF THE POSSIBILITY OF SUCH DAMAGES. SPECIFICALLY, SEITBIPL IS NOT LIABLE FOR ANY COSTS, SUCH AS LOST PROFITS OR REVENUE, WHETHER DIRECT OR INDIRECT, LOSS OF EQUIPMENT, LOSS OF USE OF EQUIPMENT, LOSS OF SOFTWARE, LOSS OF DATA, COSTS OF SUBSTITUANTS, CLAIMS BY THIRD PARTIES, OR OTHERWISE.

To obtain service under warranty you must call customer support. Customers with warranty claims issues may access the SEITBIPL worldwide customer support network through the SEITBIPL Web site: **www.apc.com**. Select your country from the country selection drop down menu. Open the Support tab at the top of the web page to obtain information for customer support in your region. Refer to the product user manual for more information on how to contact customer support.

APC by Schneider Electric Customer Support

Internet	http://www.apc.com/in
Toll Free	18001030011/18004194272
E-mail	indiainfo@se.com