

User Manual Easy UPS On-Line SRV Series 1000 VA, 2000 VA, 3000 VA

Important Safety Instructions

SAVE THESE INSTRUCTIONS - This section contains important instructions that should be followed during installation and maintenance of the Easy UPS and batteries.

Read these instructions carefully and look at the equipment to become familiar with the device before trying to install, operate, service or maintain it. The following special messages may appear throughout this document or on the equipment to warn of potential hazards or to call attention to information that clarifies or simplifies a procedure.



The addition of this symbol to either a “Danger” or “Warning” safety label indicates that an electrical hazard exists which will result in personal injury if the instructions are not followed.



This is the safety alert symbol. It is used to alert you to potential personal injury hazards. Obey all safety messages that follow this symbol to avoid possible injury or death.

DANGER

DANGER indicates a hazardous situation which, if not avoided, **will result in death or serious injury**.

WARNING

WARNING indicates a hazardous situation which, if not avoided, **could result in death or serious injury**.

CAUTION

CAUTION indicates a hazardous situation which, if not avoided, **could result in minor or moderate injury**.

NOTICE

NOTICE is used to address practices not related to physical injury.

Product Handling Guidelines

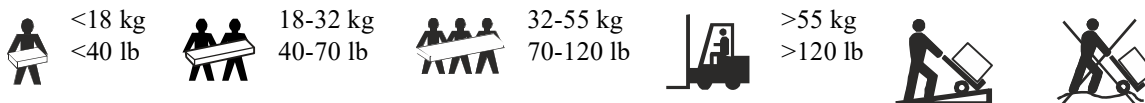

Safety and General Information

**Inspect the package contents upon receipt. Notify the carrier and dealer if there is any damage.
Read the Safety Guide supplied with this unit before installing the UPS.**

- Adhere to all national and local electrical codes.
- This UPS is intended for indoor use only.
- Do not operate this UPS in direct sunlight, in contact with fluids, or where there is excessive dust or humidity.
- Be sure that the air vents on the UPS are not blocked. Allow adequate space for proper ventilation.
NOTE: Allow a minimum of 20 cm clearance on all four sides of the UPS.
- Environmental factors impact battery life. Elevated ambient temperatures, poor quality utility power causing frequent short duration discharges will shorten battery life.
- Connect the UPS power cable directly to a wall outlet. Do not use surge protectors or extension cords.
- The equipment is heavy. Always practice safe lifting techniques adequate for the weight of the equipment.

Electrical safety

- When grounding cannot be verified, disconnect the equipment from the utility power outlet before installing or connecting to other equipment. Reconnect the power cord only after all connections are made.
- Connection to the branch circuit (mains) must be performed by a qualified electrician.
- The protective earth conductor for the UPS carries the leakage current from the load devices (computer equipment). An insulated ground conductor is to be installed as part of the branch circuit that supplies the UPS. The conductor must have the same size and insulation material as the grounded and ungrounded branch circuit supply conductors. The conductor will be green and with or without a yellow stripe.
- The grounding conductor is to be grounded to earth at the service equipment, or if supplied by a separately derived system, at the supply transformer or motor generator set.

Battery safety

- Servicing of user replaceable batteries should be performed or supervised by personnel knowledgeable about batteries and required precautions.
NOTE: In this case, batteries is not user replace.
- APC by Schneider Electric uses Maintenance-Free sealed Lead Acid batteries. Under normal use and handling, there is no contact with the internal components of the batteries. Over charging, over heating or other misuse of batteries can result in a discharge of battery electrolyte. Released electrolyte is toxic and may be harmful to the skin and eyes.
- Use tool with insulated handles.
- Wear rubber gloves and boots.
- Determine if battery is either intentionally or inadvertently grounded. Contact with any part of a grounded battery can result in electric shock and burns by high short-circuit current. The risk of such hazards can be reduced if grounds are removed during installation and maintenance by a skilled person.
- **CAUTION:** Failed batteries can reach temperatures that exceed the burn thresholds for touchable surfaces.
- **CAUTION:** A battery can present a risk of electric shock and burns by high short-circuit current. Contact with any part of a grounded battery can result in electrical shock.

Radio Frequency Warning





This equipment has been tested and found to comply with the limits for a Class A digital device, pursuant to part 15 of the FCC Rules. These limits are designed to provide reasonable protection against harmful interference when the equipment is operated in a commercial environment. This equipment generates, uses, and can radiate radio frequency energy and, if not installed and used in accordance with the instruction manual, may cause harmful interference to communications. Operation of this equipment in a residential area is likely to cause harmful interference in which case the user will be required to correct the interference at his own expense.

Product Description

The APC by Schneider Electric Easy UPS is a high performance, uninterruptible power supply (UPS). The UPS helps to provide protection for electronic equipment from utility power blackouts, brownouts, sags, and surges and small utility fluctuations and large disturbances. The UPS also provides battery backup power for connected equipment until utility power returns to normal levels or the batteries are fully discharged.

This user manual is available on the enclosed Documentation CD and on the APC by Schneider Electric Web site, www.apc.com.

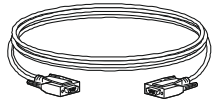
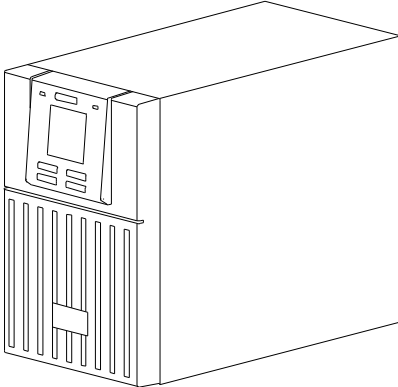
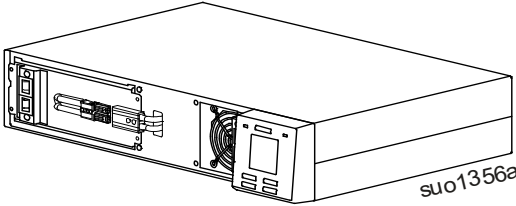
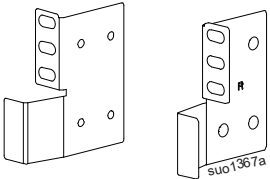
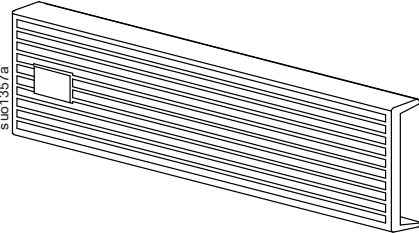
Package Contents

 User documentation	 Software, User documentation CD	 USB cable	 Serial communication cable
Tower Model		Rack Model	
 Easy UPS	 Easy UPS	 Rack-mount bracket x 1 pair	
 Front bezel	 Flat head screws x8		

NOTE:

The model and serial numbers are located on a label in the top panel.
 The packaging is recyclable; save it for reuse or dispose of it properly.

Optional Accessories

Refer to the APC by Schneider Electric Web site, www.apc.com, for optional accessories.

Specifications

Environmental specifications

NOTICE

RISK OF EQUIPMENT DAMAGE

- Easy UPS must be used indoors only.
- The installation location should be sturdy to withstand the weight of the Easy UPS.
- Do not operate Easy UPS where there is excessive dust or where the temperature or humidity are outside specified limits.

Failure to follow these instructions can result in equipment damage.

Temperature	Operating	<ul style="list-style-type: none"> • 0 to 40 °C at rated load • 40 to 50 °C linearly derated to 80% of maximum load capacity
	Storage	-20 to 50 °C
Elevation	Operating	<ul style="list-style-type: none"> • 0 to 2,000 m: Normal operation • > 2,000 m: The output power reduces @ 1% for increase in height of every 100 m
	Storage	0 to 15,000 m
Humidity		0 to 95% relative humidity, non-condensing
International Protection Code		IP20

NOTE: Charge the battery module at least once in every six months during storage.

Physical specifications

Tower Model

	SRV1KA-CA	SRV2KA-CA	SRV3KA-CA
Dimensions with package Width x Height x Depth	235 x 330 x 365 mm (9.25 x 12.99 x 14.37 in)	235 x 355 x 525 mm (9.25 x 13.98 x 20.67 in)	325 x 465 x 565 mm (12.8 x 18.31 x 22.24 in)
Dimensions without package Width x Height x Depth	145 x 223 x 288 mm (5.7 x 8.78 x 11.34 in)	145 x 238 x 400 mm (5.7 x 9.37 x 15.75 in)	190 x 336 x 425 mm (7.5 x 13.2 x 16.7 in)
Weight with package (approx.)	10.9 kg	18.3 kg	29.3 kg
Weight without package (approx.)	9.6 kg	17 kg	27.1 kg

Rack Model

	SRV1KRA-CA	SRV2KRA-CA	SRV3KRA-CA
Dimensions with package Width x Height x Depth	455 x 218 x 550 mm (17.9 x 8.6 x 21.7 in)	550 x 218 x 700 mm (21.7 x 8.6 x 27.56 in)	570 x 228 x 794 mm (22.4 x 9 x 31.3 in)
Dimensions without package Width x Height x Depth	438 x 86 x 312 mm (17.2 x 3.4 x 12.3 in)	438 x 86 x 462 mm (17.2 x 3.4 x 18.2 in)	438 x 86 x 632 mm (17.2 x 3.4 x 24.9 in)
Weight with package (approx.)	14 kg	22.5 kg	32.5 kg
Weight without package (approx.)	11.5 kg	18.8 kg	28.5 kg

Input specifications

	SRV1KA-CA SRV1KRA-CA	SRV2KA-CA SRV2KRA-CA	SRV3KA-CA SRV3KRA-CA
Nominal input voltage	120 VAC		
Input frequency	40 - 70 Hz		
Input voltage range (100% load)	85 - 150 VAC		
Input voltage range (50% load)	55 - 150 VAC		
Input power factor (100% resistive load at nominal voltage)	≥ 0.95		
Input protection	Circuit breaker		

Output specifications

	SRV1KA-CA SRV1KRA-CA	SRV2KA-CA SRV2KRA-CA	SRV3KA-CA SRV3KRA-CA
Easy UPS Capacity	1000 VA/800 W	2000 VA/1600 W	3000 VA/2400 W
Nominal output voltage	120 VAC		
Other programmable voltage	110 VAC, 115 VAC		
Efficiency at rated load	88% max.		
Output voltage regulation	±1% static		
Output voltage distortion	<ul style="list-style-type: none"> • 3% max. for full linear load • 6% max. for full RCD load (100% VA, 0.8 PF) • 15% for the last 60 seconds of the backup time (with full load only for the internal battery) 		
Frequency - On battery	50 Hz/60 Hz ± 0.5%		
Frequency - AC mode	50 Hz/60 Hz ± 3 Hz		
Crest factor	3:1		
Waveform	Sinewave		
Output connection	Refer "Rear Panel Features" on page 7 for details		
Bypass	Internal		

Battery

CAUTION

RISK OF HYDROGEN SULPHIDE GAS AND EXCESSIVE SMOKE

- Replace the battery at least every 5 years or at the end of its service life, whichever is earlier.
- Replace the battery immediately when the Easy UPS indicates battery replacement is necessary.
- Replace batteries with the same number and type of batteries as originally installed in the equipment.
- Replace the battery immediately when the Easy UPS indicates a battery over-temperature condition, or when there is evidence of electrolyte leakage. Power off the Easy UPS, unplug it from the AC input, and disconnect the batteries. Do not operate the Easy UPS until the batteries have been replaced.
- *Replace all Battery packs which are older than one year, when installing additional battery packs.

Failure to follow these instructions can result in minor or moderate injury and equipment damage.

* Contact APC by Schneider Electric Customer Support to determine the age of the installed battery modules.

UPS Model	SRV1KA-CA SRV1KRA-CA	SRV2KA-CA SRV2KRA-CA	SRV3KA-CA SRV3KRA-CA
Configuration	Internal battery		
Type	Sealed maintenance free valve regulated lead acid battery, 12 V, 9 Ah		
Battery Voltage	24 VDC	48 VDC	72 VDC

Rack-Mount Installation

⚠ CAUTION

RISK OF FALLING EQUIPMENT

- The Easy UPS is heavy.
- Always practice safe lifting techniques adequate for the weight of the equipment.
- Do not lift the Easy UPS by holding the front panel display.
- Always install the UPS at the bottom of the rack.
- Given the heavy weight, the use of rack-mount brackets is mandatory during rack installation (guide with L-shaped support).
- Always use the recommended number of screws to secure brackets to the UPS.
- Install the Easy UPS above the external battery pack.
- Secure the unit in the rack using all the screws supplied for the purpose.

Failure to follow these instructions can result in minor or moderate injury and equipment damage.

- Be sure that the 19 inch rack is equipped with a shelf before installing the UPS and battery pack into the rack enclosure.
- Be sure that the installed shelf can withstand the weight of the UPS and/or battery pack. Otherwise, install an optional rail kit accessory which can be purchased separately.

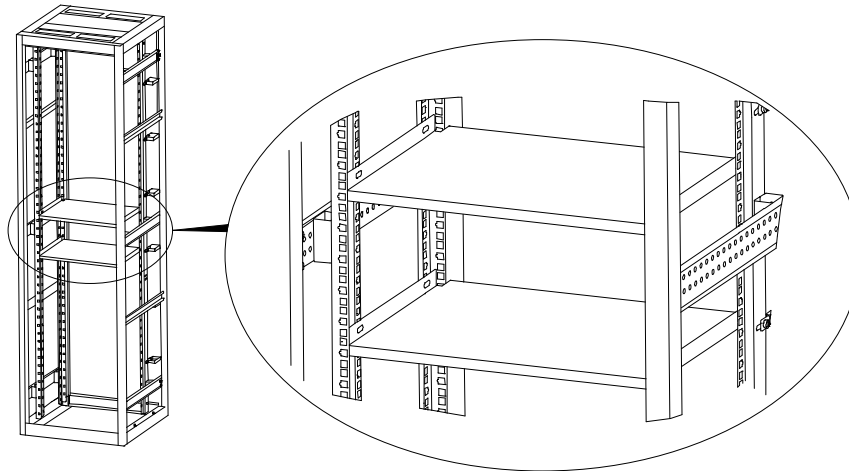

1 Install the rack-mount brackets.

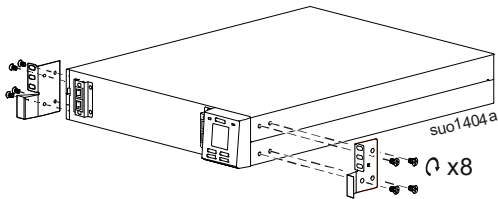

2 Lift the Easy UPS module and slide it into rack enclosure.

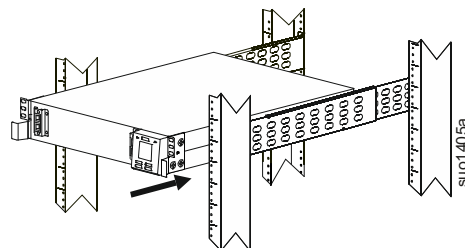

3 Secure the Easy UPS module to the rack with screws, nuts and washers (not supplied).

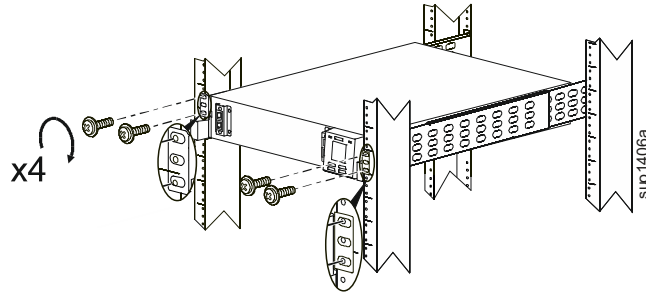

4 Snap the battery connectors together.
NOTE: The Rack Model Easy UPS is shipped with the internal battery disconnected.

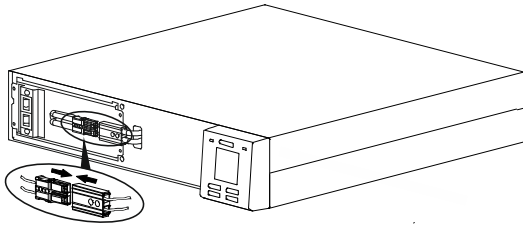

5 Install the front bezel.

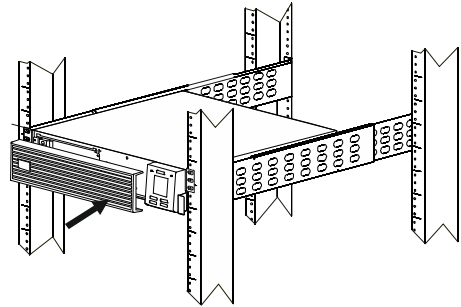

Rear Panel Features

Tower Model

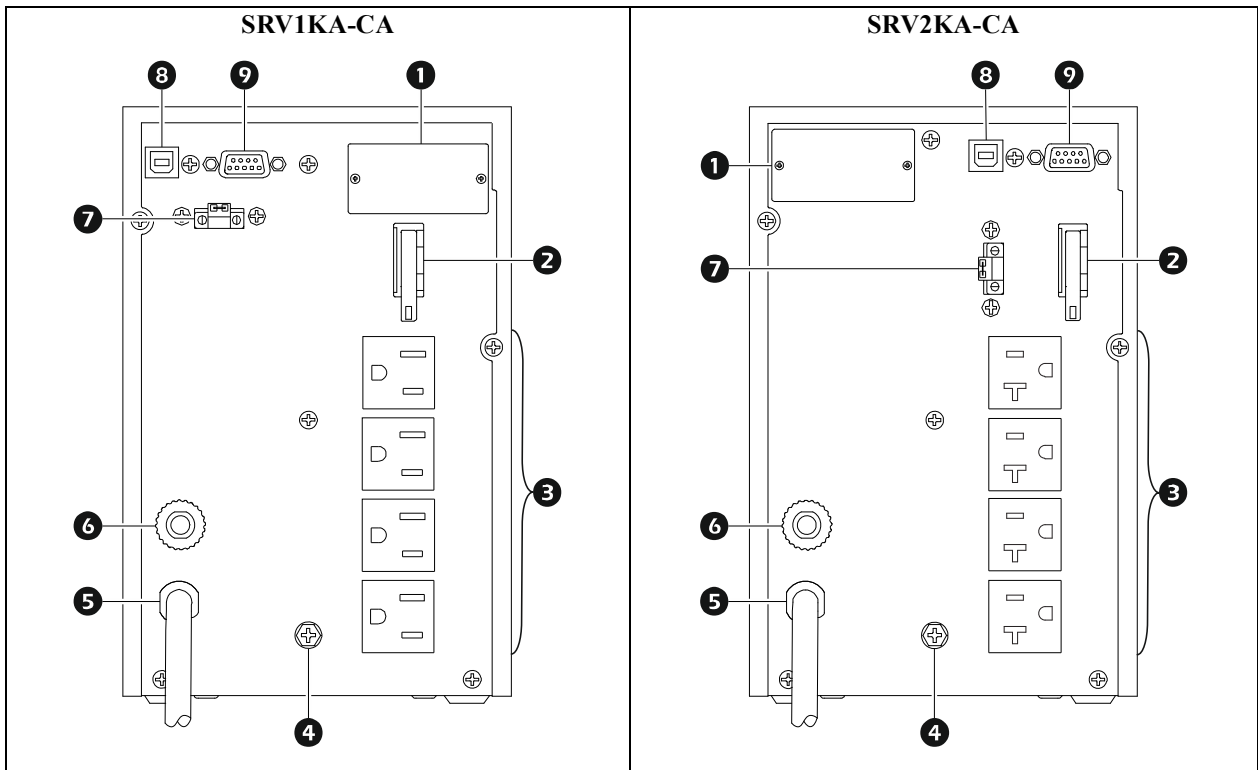

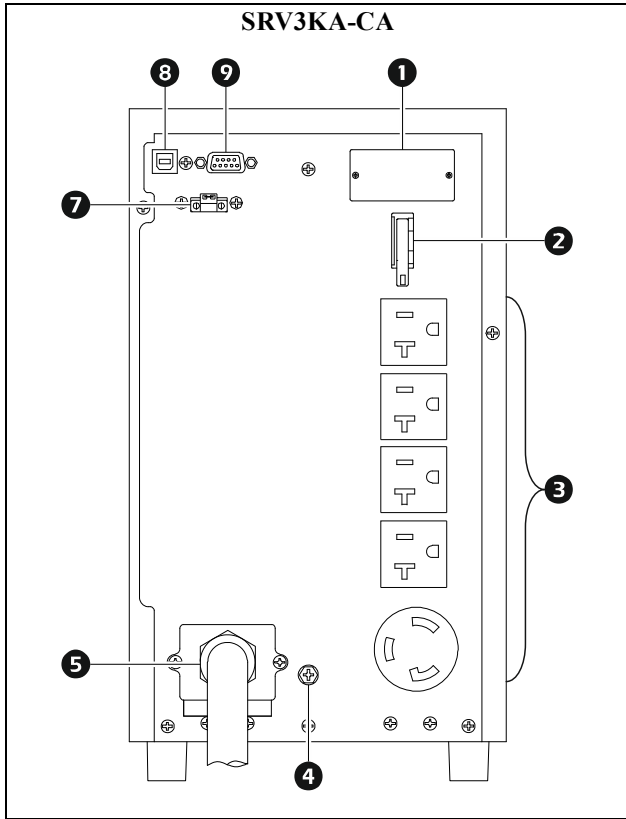

1	Intelligent Card Slot
2	Battery Connector
3	Output Outlets
4	Ground Terminal
5	AC Input
6	Input Circuit Breaker
7	Emergency Power Off (EPO) Switch
8	USB Communication Port
9	RS-232 Serial Port

Rack Model

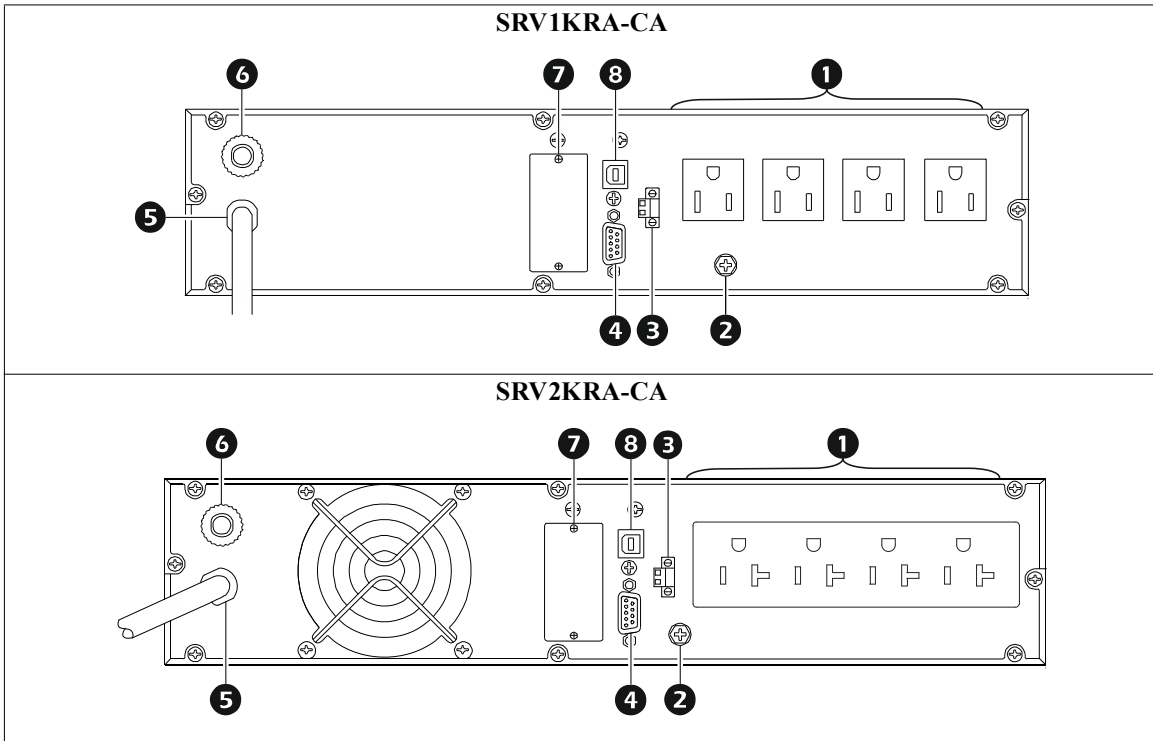

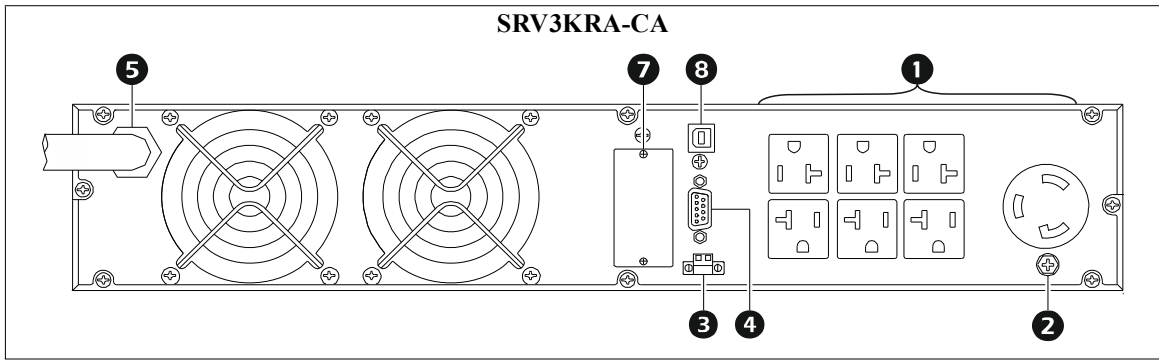

①	Battery Backup Outlets
②	Ground Terminal
③	Emergency Power Off (EPO) Switch
④	RS-232 Serial Port
⑤	AC Input
⑥	Input Circuit Breaker
⑦	Intelligent Card Slot
⑧	USB Communication Port

Start Up

Connect the battery

Tower model

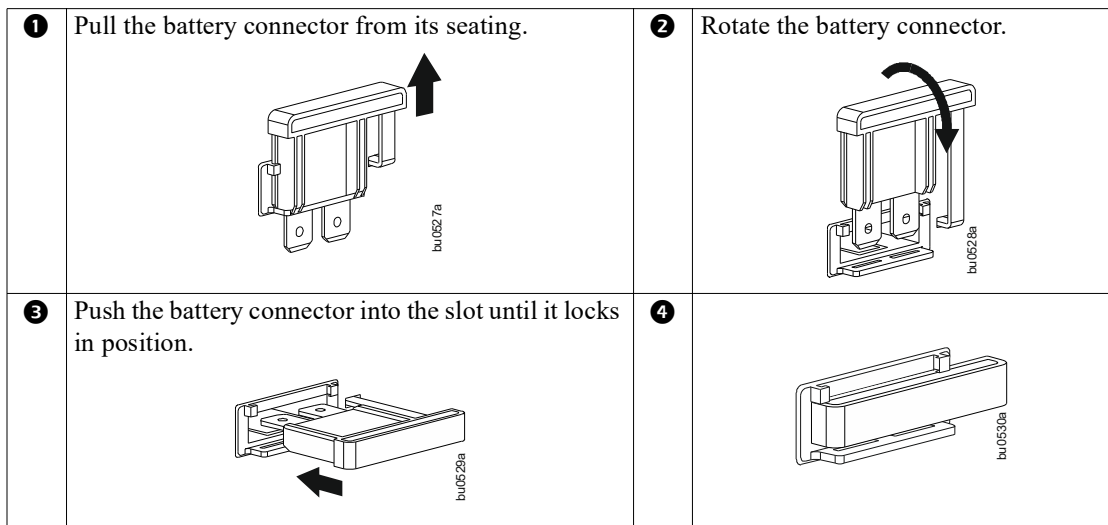

Rack model

Refer “Snap the battery connectors together.” on page 7 for connecting battery details.

Connect equipment and input power to the Easy UPS

⚠ CAUTION

RISK OF ELECTRIC SHOCK

- All electrical work must be performed by a qualified electrician.
- Turn off all power to this equipment before working on the equipment.
- Practice lockout/tagout procedures.
- Do not wear jewelry when working with electrical equipment.

Failure to follow these instructions can result in moderate injury.

1. Connect equipment to the output outlets of the Easy UPS. Refer “Rear Panel Features” on page 7 for details.
NOTE: Do not use extension cords.
2. Connect input utility power to the Easy UPS.
3. Turn on the input utility power. The Easy UPS front panel display will illuminate.

Start the Easy UPS

Press and hold the POWER ON/OFF button located on the front panel of Easy UPS until a beep is heard. The **Status** LED will illuminate green.

- The battery charges to 90% capacity during the first five hours of normal operation.
- **Do not** expect full backup time during this initial charge period.

Cold start the Easy UPS

Use cold start feature to supply power to connected equipment from the Easy UPS batteries.

Press and hold the POWER ON/OFF button located on the front panel of Easy UPS until a beep is heard. The front panel display will illuminate.

Press the POWER ON/OFF button again to supply battery power to the connected equipment.

Connect and install management software

Easy UPS is provided with SchneiderUPS management software for unattended operating system shutdown, monitoring, control and energy reporting. The following diagram is a representation of a typical server installation.

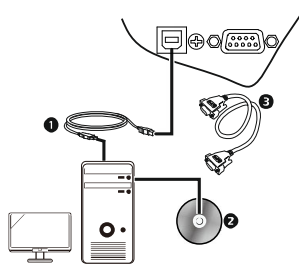

❶	Connect the USB cable from the rear of the Easy UPS to the computer.
❷	Load the SchneiderUPS CD and follow the on-screen set-up instructions.
❸	A built-in serial port is also available for additional communication options with serial cable.

Additional communication options are available via the built-in intelligent slot. Refer to APC by Schneider Electric Web site, www.apc.com for more information.

Emergency Power Off

NOTICE

RISK OF EQUIPMENT DAMAGE

- Do not connect the EPO interface to any circuit other than an unused circuit.
- Adhere to all national and local electrical codes.
- Wiring must be performed by a qualified electrician.

Failure to follow these instructions can result in equipment damage.

The Emergency Power Off (EPO) function is a feature that will immediately remove power to all connected equipment. When EPO button is pressed, all connected equipment will immediately turn off.

The EPO interface is a Safety Extra Low Voltage (SELV) circuit and should be connected only to other SELV circuits.

The EPO switch is internally powered by the Easy UPS for use with non-powered switches or potential free normally closed (N/C) contacts.

Connecting normally closed (N/C) contacts

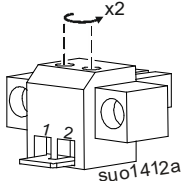
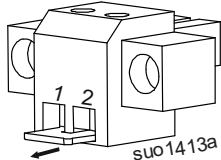
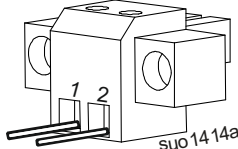
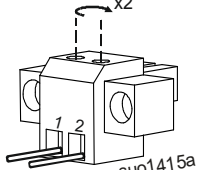
<p>❶ Loosen the screws of terminals 1 and 2 in the EPO connector.</p> 	<p>❷ Remove the metal link between pins 1 and 2.</p> 
<p>❸ Connect N/C relay contacts between pins 1 and 2 of the EPO terminal block. Use 0.5 to 1 mm² wire.</p> 	<p>❹ Secure the EPO connector screws beneath pins 1 and 2.</p> 

NOTE: If the N/C is open, the Easy UPS output power will turn off.

Use Class 2 cable (CL2) to connect the Easy UPS to the EPO switch.

Operation



Front panel display features

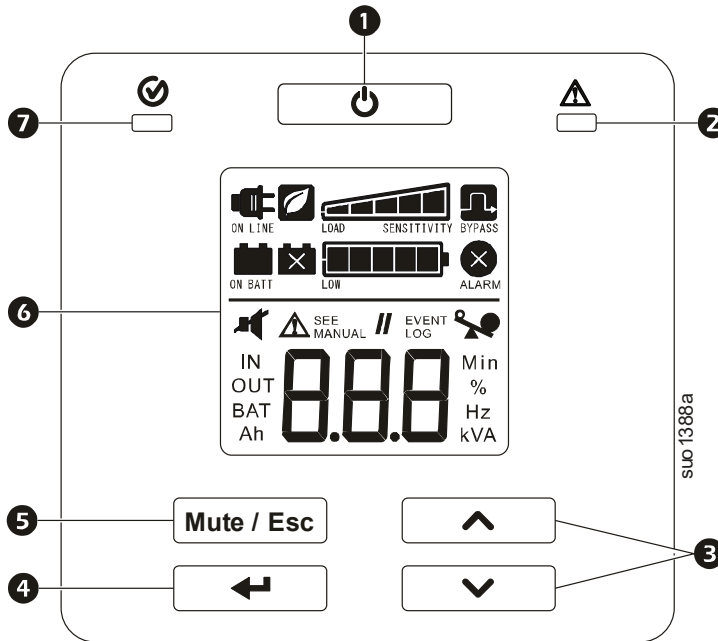









Easy UPS models are equipped with an intuitive and configurable LCD display. The display complements the software interface as they convey similar information and either may be used to configure the Easy UPS settings.



1 POWER ON/OFF button	Press the POWER ON/OFF button to turn the Easy UPS on. Press and hold the POWER ON/OFF button until a beep is heard to turn the Easy UPS off. Press the POWER ON/OFF button to reset alerts.
2 Alert LED	The Alert LED illuminates red when the Easy UPS detects an internal error and blinks red for Easy UPS notifications. Refer “Alerts and Notifications” on page 17 for details.
3 UP/DOWN ARROW button	Press the UP/DOWN ARROW button to scroll through the main menu options and display screens.
4 ENTER button	Press the ENTER button to enter the menu or to select a menu item/value during navigation.
5 MUTE/ESC button	Press the MUTE/ESC button: <ul style="list-style-type: none"> • To acknowledge audible alerts and suppress them temporarily. • To exit a sub menu and return to the main menu.
6 LCD Display	The display interface options are visible on this LCD screen. Press any button to activate LCD, if the display is not illuminated.
7 Status LED	The Status LED illuminates green when the power is on. The LED indicates two different states of output power: <ul style="list-style-type: none"> • Output off: LED blinks on and off. Press POWER ON/OFF button to turn the output power on. • Output on: LED illuminates green continuously.

Front panel display icons

	On Line: The Easy UPS is drawing utility power and performing double conversion to supply power to the connected equipment.
	On Battery: The Easy UPS is supplying battery backup power to the connected equipment.

	Replace Battery: The battery is not connected securely or the battery is nearing the end of its service life and should be replaced.
 BYPASS	Bypass: The Easy UPS is in bypass mode, sending utility power directly to connected equipment. Bypass mode operation is the result of an internal UPS event, an overload condition, or an user initiated command through an accessory. Battery operation is not available while the Easy UPS is in bypass mode. Refer “Alerts and Notifications” on page 17 for details. This icon in combination with Green Mode icon, indicates that the UPS is in Green Mode operation.
 ALARM	System Alerts: The Easy UPS has detected an internal error. Refer “Alerts and Notifications” on page 17 for more details.
	Overload: The equipment connected to the Easy UPS is drawing more power than rated.
	Battery Charge: The battery charge level is indicated by the number of bar sections illuminated. When all five blocks are illuminated, the battery is fully charged. Each bar represents approximately 20% of the battery charge capacity.
	Load Level: The load percentage is indicated by the number of load bar sections illuminated. Each bar represents approximately 20% of the load.
	Mute: An illuminated line through the icon indicates that the audible alert is disabled.
	Green Mode: An illuminated icon indicates that the unit is working in Green mode. The connected equipment is receiving the utility input directly as long as the input voltage and frequency are within the configured limits.
	Alert or notification: The Easy UPS has detected an internal error or the Easy UPS is in configuration mode. Refer “Alerts and Notifications” on page 17 for details.
	Event: The icon is illuminated when the user is viewing the event log.

Status Indicators

Audible Alert	Condition
Continuous beeps, every half second	Low Battery State - The battery is nearing its discharge state. The Easy UPS is about to shutdown. Overload condition - The equipment connected to the Easy UPS is drawing more power than rated.
4 beeps every 30 sec (first beep starts after 4 sec on battery)	On Battery State - The Easy UPS is supplying battery backup power to the connected equipment.
Continuous beeps	Alert State - Easy UPS has detected an internal error. Refer “Alerts and Notifications” on page 17 for details.
Short beep every 2.5 sec	Battery disconnected.
Continuous short beeps every half second for 1 minute, repeats every 5 hours	Replace battery.
Two short beeps every 5 sec	Event Bypass State - Easy UPS has detected an internal error. Connected equipment receives utility input power through the bypass relay.

Easy UPS Display Parameters

Operational data displayed in the front panel display is given in the table. Navigate using the UP/DOWN ARROW buttons.

Parameter	Units	Indicator Icons
Output voltage	VAC	OUT, V
Output frequency	Hz	OUT, Hz
Input voltage	VAC	IN, V
Input frequency	Hz	IN, Hz
Battery voltage	VDC	BAT, V
Ambient temperature	°C	Number, C
State of battery charge	%	BAT, %
Load level in percentage (Maximum of Watts or VA)	%	OUT, %
Load level in kVA	kVA	OUT, kVA
Total Ah capacity of connected battery	Ah	BAT, Ah
Remaining On Battery runtime	Minutes	BAT, Min

Configuration

Easy UPS settings

Configure Easy UPS settings using the display interface. Refer “Configure Easy UPS parameters” on page 16 to edit the parameters.

Function	Factory Default	User Selectable Options	Description
Output voltage	120 VAC	<ul style="list-style-type: none"> • 110 VAC • 115 VAC • 120 VAC 	Allows the user to select output voltage while the Easy UPS is operating online.
Audible alert	Enable	Enable/Disable	Allows the user to mute the audible alerts of the Easy UPS when set to disable or when the front panel display MUTE button is pressed.
Green mode / high efficiency mode	Disable	Enable/Disable	<p>When this mode is enabled, connected equipment receives utility input power through the bypass relay as long as input voltage is within the range of $\pm 5\%$ of configured output voltage and ± 3 Hz of configured output frequency. Inverter is turned off during this mode.</p> <p>If utility power input goes out of range, inverter is turned on. The load is transferred to online mode or battery mode. The power to the connected equipment may be interrupted up to 10 milliseconds.</p>
Minimum battery capacity to restart setting	0%	0%, 15%, 50%, 90%	Easy UPS output will not be turned on until the battery is charged to a level such that it can provide the runtime configured by this setting. If configured to 0%, Easy UPS output is turned on immediately after utility power returns.
Low battery state indication setting	2 min	2 min, 5 min, 7 min, 10 min	The Easy UPS will emit an audible alert when the actual run time reaches the limit set by the user. The audible alert will emit only when the Easy UPS is working in battery mode.

Advanced Display Navigation

The Easy UPS display has five menu options in the UPS display. Press the ENTER button from the Home Screen to access these menu options. Use the UP/DOWN ARROW buttons to navigate between the menu options.

Menu option	Description
SEt	<p>Configure the Easy UPS Use this menu option to configure the Easy UPS parameters. Press the ENTER button to see the configuration options. Refer “Configure Easy UPS parameters” on page 16 for details. Press the MUTE/ESC button to return to the Home Screen.</p>
LOG	<p>Show Event Log Use this menu option to see the Easy UPS event log. The Easy UPS records the last 10 events and displays the codes in this log. Press the ENTER button to see the log. Use the UP/DOWN ARROW buttons to see the logged events. The DOWN ARROW button navigates towards old events and the UP ARROW button navigates to new events. Every log entry has a numeric and textual event code. At the end of the log, the word “End” will be displayed. Press the MUTE/ESC button to return to the Home Screen.</p>
UPS	<p>Show Easy UPS information Use this menu option to see the Easy UPS information. Press the ENTER button to see the rating of the Easy UPS. Press the UP ARROW button to see the Easy UPS firmware version. Press the MUTE/ESC button to return to the Home Screen.</p>
bYP	<p>User Command to bypass Use this menu option to switch the Easy UPS to bypass mode or bring the Easy UPS to online mode from bypass mode. Press ENTER button:</p> <p>Put Put: Use to switch the Easy UPS to bypass mode of operation. NOTE: Power to the connected equipment will drop, if the mains voltage is not within the threshold limits.</p> <p>Out Out: Bring the Easy UPS out of bypass and restore clean power to the connected equipment. The Easy UPS will start a count down on the display while switching to Bypass mode or coming out of Bypass mode.</p>
tSt	<p>Execute Battery Self Test Use this menu option to conduct a self test and determine the battery status. Press the ENTER button to initiate the test. If the test command is accepted, the Easy UPS will initiate a self test and will start a count down on the display. Display messages are shown at the end of the test.</p> <p>rFd Test refused. The output is off or battery is not charged or battery is disconnected.</p> <p>FLd Test not passed.</p> <p>PRs Test passed.</p> <p>Abt Test is aborted due to internal reasons.</p> <p>Press the MUTE/ESC button to return to the Home Screen.</p>

Configure Easy UPS parameters

Follow the steps to configure parameters in the Easy UPS:

1. Press the ENTER button.
2. Press the UP/DOWN ARROW buttons to navigate to “Set”.
3. Press the ENTER button.
4. Navigate through the parameters using the UP/DOWN ARROW buttons.
5. Press the ENTER button to edit a parameter. Icons start flashing to indicate the editing.
6. Press the UP/DOWN ARROW buttons to navigate between the options available for the selected parameter.
7. Press the ENTER button to select the option or MUTE/ESC button to abort the editing of current parameter. Flashing of icons stops after this.
8. Press the UP/DOWN ARROW buttons to navigate between parameters.
9. Press the MUTE/ESC button to exit menu navigation.

Troubleshooting

Use the table below to solve minor installation and operation problems. Refer to the APC by Schneider Electric Web site, www.apc.com for assistance with complex Easy UPS problems.

Problem and/or Possible Cause	Solution
Easy UPS will not turn on when utility input is available	
The Easy UPS is not turned on.	Press the POWER ON/OFF button to turn on the Easy UPS.
The Easy UPS is not connected to utility power supply.	Be sure that the power cable from the Easy UPS to the utility power supply is securely connected at both ends.
Input circuit breaker on the Easy UPS is tripped.	Reset the thermal circuit breaker in the rear panel. Refer “Rear Panel Features” on page 7 for details.
Easy UPS is operating on battery, while connected to the input utility power	
There is high, low, or distorted input voltage or frequency.	Connect the UPS to a different outlet on a different circuit. Test the utility input power to ensure the unit is receiving input power. If display is on, navigate and check the input voltage and frequency.
Easy UPS, when connected to battery, is not supplying power to the connected equipment	
The Easy UPS is not turned on.	If the Easy UPS has shutdown (the display is not on), turn the Easy UPS on by following the Cold start procedure. Refer “Cold start the Easy UPS” on page 10 for details.
Low battery cut off. Easy UPS may have discharged the battery due to utility power outage and turned the output off due to low battery condition.	Wait for the utility power to be restored and charge the battery. Press the POWER ON/OFF button to turn on the output power after utility power returns.
Easy UPS emits an audible beeping sound at long intervals	
The Easy UPS is operating normally when running on battery.	Wait for the utility power to be restored.
Alert LED is illuminated. The Easy UPS displays an alert message and emits a constant beeping sound	
The Easy UPS has detected an internal error.	Refer “Alerts and Notifications” on page 17 for details.
No audible sounds from Easy UPS even when the Alert LED is illuminated	
Audible alert is disabled.	Change the Easy UPS configuration to enable audible alerts.

Problem and/or Possible Cause	Solution
Easy UPS is not providing expected backup time	
The Easy UPS battery is discharged due to a recent power outage.	The batteries require recharging after extended outages. Batteries can wear faster when put into service without proper recharging or when operated at elevated temperatures.
The battery is near the end of its service life.	If the battery is near the end of its service life, consider replacing the battery, even if the Replace Battery LED is not illuminated.
Easy UPS is not turning off	
POWER ON/OFF button not pressed properly.	Press and hold the power on/off button until the beep is heard to power off the UPS.
Utility input power is available.	Easy UPS logic power cannot be turned off if utility input power is available. To turn off the Easy UPS, turn off utility input power and press POWER OFF button. Release when a beep is heard.
Easy UPS is in Bypass mode and the LED is not illuminated red	
Easy UPS is in Green mode.	Disable Green mode if not required.
Easy UPS is configured to stay in the bypass mode.	Change the configuration to exit bypass mode.
Easy UPS is in bypass mode even after over temperature alarm is cleared.	Reduce the connected load to < 70% to bring the Easy UPS to online mode.
The Easy UPS has experienced an overload condition and transferred to bypass.	Connected equipment exceeds the maximum load as defined in specifications. The alerts remain on until the overload condition is corrected. Disconnect nonessential equipment from the Easy UPS to eliminate the overload condition. The Easy UPS continues to supply power as long as it is in bypass mode and the circuit breaker does not trip. Easy UPS will not transfer to battery in the event of power failure.
Easy UPS is in Bypass mode and the LED is illuminated red	
Easy UPS detected an internal error and transferred to bypass.	Refer "Alerts and Notifications" on page 17 for details.

Alerts and Notifications

Easy UPS displays a text code and a numeric code on the display when it detects an internal error.

Alerts

Display code	Description	Solution
SC	Easy UPS has experienced a short circuit at the output. Unit will try to auto-recover from this condition.	Check if there is any short circuit at the UPS output. Remove the short circuit wait the unit auto-recover or press POWER ON/OFF button to start the UPS. NOTE: The power supplied to the connected equipment is dropped when the UPS is in this condition.
OL	Easy UPS is experiencing an overload condition.	Disconnect nonessential equipment from the Easy UPS to eliminate the overload condition.
dCH	The Easy UPS has detected a DC voltage error. Unit will try to auto-recover from this condition.	If the Easy UPS does not recover automatically, contact APC by Schneider Electric.

Display code	Description	Solution
H0E	Temperature of the unit is rising above the set limits.	Disconnect nonessential equipment from the Easy UPS to reduce the load. Ensure that ambient temperature is within limits. Ensure that adequate clearance is maintained.
CH9	Easy UPS has detected a charger error.	Verify if there is any short circuit at the UPS battery terminal. Press POWER ON/OFF button to start the UPS.
Contact APC by Schneider Electric for all other alert codes.		

Notifications

Display code	Description	Solution
bdc	Battery is not connected.	Connect battery to the Easy UPS. Refer “Connect the battery” on page 9 for details.

Transport

1. Shut down and disconnect all connected equipment.
2. Disconnect the unit from mains power.
3. Disconnect external batteries.
4. Follow the shipping instructions outlined in the *Service* section of this manual.

Service

If the unit requires service, do not return it to the dealer. Follow these steps:

1. Review the *Troubleshooting* section of the manual to eliminate common problems.
2. If the problem persists, contact APC by Schneider Electric Customer Support through the APC by Schneider Electric Web site, www.apc.com.
 - a. Note the model number and serial number and the date of purchase. The model and serial numbers are located on a label in the top panel of the unit and are available through the LCD display on select models.
 - b. Call APC by Schneider Electric Customer Support and a technician will attempt to solve the problem over the phone. If this is not possible, the technician will issue a Returned Material Authorization Number (RMA#).
 - c. If the unit is under warranty, the repairs are free.
 - d. Service procedures and returns may vary internationally. For country specific instructions refer to the APC by Schneider Electric Web site, www.apc.com.
3. Pack the unit properly to avoid damage in transit. Never use foam beads for packaging. Damage sustained in transit is not covered under warranty. Note: Before shipping, always disconnect battery modules in a UPS or external battery pack. The disconnected internal batteries may remain inside the UPS or external battery pack.
4. Write the RMA# provided by Customer Support on the outside of the package.
5. Return the unit by insured, prepaid carrier to the address provided by Customer Support.

Limited Factory Warranty

Schneider Electric IT Corporation (SEIT), warrants its products to be free from defects in materials and workmanship for a period of two (2) years from the date of purchase. The SEIT obligation under this warranty is limited to repairing or replacing, at its own sole option, any such defective products. Repair or replacement of a defective product or part thereof does not extend the original warranty period.

This warranty applies only to the original purchaser who must have properly registered the product within 10 days of purchase. Products may be registered online at warranty.apc.com.

SEIT shall not be liable under the warranty if its testing and examination disclose that the alleged defect in the product does not exist or was caused by end user or any third person misuse, negligence, improper installation, testing, operation or use of the product contrary to SEIT recommendations of specifications. Further, SEIT shall not be liable for defects resulting from: 1) unauthorized attempts to repair or modify the product, 2) incorrect or inadequate electrical voltage or connection, 3) inappropriate on site operation conditions, 4) Acts of God, 5) exposure to the elements, or 6) theft. In no event shall SEIT have any liability under this warranty for any product where the serial number has been altered, defaced, or removed.

EXCEPT AS SET FORTH ABOVE, THERE ARE NO WARRANTIES, EXPRESS OR IMPLIED, BY OPERATION OF LAW OR OTHERWISE, APPLICABLE TO PRODUCTS SOLD, SERVICED OR FURNISHED UNDER THIS AGREEMENT OR IN CONNECTION HERewith. SEIT DISCLAIMS ALL IMPLIED WARRANTIES OF MERCHANTABILITY, SATISFACTION AND FITNESS FOR A PARTICULAR PURPOSE.

SEIT EXPRESS WARRANTIES WILL NOT BE ENLARGED, DIMINISHED, OR AFFECTED BY AND NO OBLIGATION OR LIABILITY WILL ARISE OUT OF, SEIT RENDERING OF TECHNICAL OR OTHER ADVICE OR SERVICE IN CONNECTION WITH THE PRODUCTS.

THE FOREGOING WARRANTIES AND REMEDIES ARE EXCLUSIVE AND IN LIEU OF ALL OTHER WARRANTIES AND REMEDIES. THE WARRANTIES SET FORTH ABOVE CONSTITUTE SEIT'S SOLE LIABILITY AND PURCHASER'S EXCLUSIVE REMEDY FOR ANY BREACH OF SUCH WARRANTIES. SEIT WARRANTIES EXTEND ONLY TO ORIGINAL PURCHASER AND ARE NOT EXTENDED TO ANY THIRD PARTIES.

IN NO EVENT SHALL SEIT, ITS OFFICERS, DIRECTORS, AFFILIATES OR EMPLOYEES BE LIABLE FOR ANY FORM OF INDIRECT, SPECIAL, CONSEQUENTIAL OR PUNITIVE DAMAGES, ARISING OUT OF THE USE, SERVICE OR INSTALLATION OF THE PRODUCTS, WHETHER SUCH DAMAGES ARISE IN CONTRACT OR TORT, IRRESPECTIVE OF FAULT, NEGLIGENCE OR STRICT LIABILITY OR WHETHER SEIT HAS BEEN ADVISED IN ADVANCE OF THE POSSIBILITY OF SUCH DAMAGES. SPECIFICALLY, SEIT IS NOT LIABLE FOR ANY COSTS, SUCH AS LOST PROFITS OR REVENUE, WHETHER DIRECT OR INDIRECT, LOSS OF EQUIPMENT, LOSS OF USE OF EQUIPMENT, LOSS OF SOFTWARE, LOSS OF DATA, COSTS OF SUBSTITUANTS, CLAIMS BY THIRD PARTIES, OR OTHERWISE.

NOTHING IN THIS LIMITED WARRANTY SHALL SEEK TO EXCLUDE OR LIMIT SEIT LIABILITY FOR DEATH OR PERSONAL INJURY RESULTING FROM ITS NEGLIGENCE OR ITS FRAUDULENT MISREPRESENTATION OF TO THE EXTENT THAT IT CANNOT BE EXCLUDED OR LIMITED BY APPLICABLE LAW.

To obtain service under warranty you must obtain a Returned Material Authorization (RMA) number from customer support. Customers with warranty claims issues may access the SEIT worldwide customer support network through the APC by Schneider Electric Web site: www.apc.com. Select your country from the country selection drop down menu. Open the Support tab at the top of the web page to obtain information for customer support in your region. Products must be returned with transportation charges prepaid and must be accompanied by a brief description of the problem encountered and proof of date and place of purchase.

APC by Schneider Electric Worldwide Customer Support

Customer support for this or any other APC by Schneider Electric product is available at no charge in any of the following ways:

- Visit the APC by Schneider Electric Web site to access documents in the APC by Schneider Electric Knowledge Base and to submit customer support requests.
 - www.apc.com (Corporate Headquarters)
Connect to localized APC by Schneider Electric Web sites for specific countries, each of which provides customer support information.
 - www.apc.com/support/
Global support searching APC by Schneider Electric Knowledge Base and using e-support.
- Contact the APC by Schneider Electric Customer Support Center by telephone or e-mail.
 - Local, country specific centers: go to www.apc.com/support/contact for contact information.

For information on how to obtain local customer support, contact the APC by Schneider Electric representative or other distributor from whom you purchased your APC by Schneider Electric product.