

Easergy MiCOM P138

Overcurrent Protection Device
for Railway Applications

P138/EN IN/Bc3

Version P138 -303 -407/408/409 -612ff

Supporting Documents

This document does not replace the Technical Manual.



Warning

When electrical equipment is in operation dangerous voltage will be present in certain parts of the equipment. Failure to observe warning notices, incorrect use or improper use may endanger personnel and equipment and cause personal injury or physical damage.

Before working in the terminal strip area, the device must be isolated. Where stranded conductors are used, wire end ferrules must be employed.

The signals 'Main: Blocked/faulty' and 'SFMON: Warning (LED)' (permanently assigned to the LEDs labelled 'OUT OF SERVICE' and 'ALARM') can be assigned to output relays to indicate the health of the device. Schneider Electric strongly recommends that these output relays are hardwired into the substation's automation system, for alarm purposes.

Any modifications to this device must be in accordance with the manual. If any other modification is made without the express permission of Schneider Electric, it will invalidate the warranty, and may render the product unsafe.

Proper and safe operation of this device depends on appropriate shipping and handling, proper storage, installation and commissioning, and on careful operation, maintenance and servicing.

For this reason only qualified personnel may work on or operate this device.

For this reason only qualified personnel may work on or operate this device. The user should be familiar with the warnings in the Safety Guide (SFTY/4LM/G11 or later version), before working on the equipment.

Installation of the DHMI:

A protective conductor (ground/earth) of at least 1.5mm² must be connected to the DHMI protective conductor terminal to link the DHMI and the main relay case; these must be located within the same substation.

To avoid the risk of electric shock the DHMI communication cable must not be in contact with hazardous live parts.

The DHMI communication cable must not be routed or placed alongside high-voltage cables or connections. Currents can be induced in the cable which may result in electromagnetic interference.

CE CE Marking

This product complies with the essential requirements of the following European directives:

Electromagnetic Compatibility Directive (EMC) 2004/108/EC

Low Voltage Directive (LVD) 2006/95/EC

Protective Conductor Terminal (PCT) / Case Grounding / Protective Earth

Location of Protection Conductor Terminal

Surface-mounted case

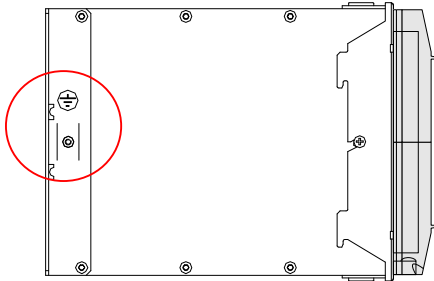

Flush-mounted case

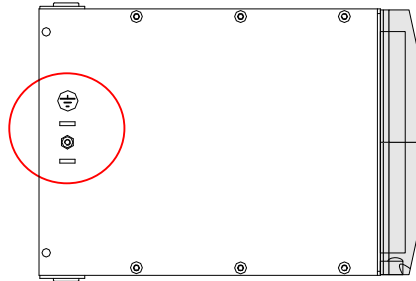

DHMI

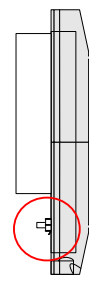

Assembly of Protection Conductor Terminal

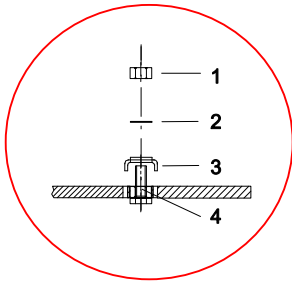

Pos.	Description
1	Nut M4
2	Tooth lock wash, A4.3
3	Clamp bracket
4	Bolt M4

The protective conductor must be permanently connected to the PCT (Protective Conductor Terminal) to maintain the safety features provided by the design. The clamp bracket is marked with a PCT symbol: . The cross-section of the ground conductor must conform to applicable national standards. A minimum cross-section of 2.5 mm² is required.

In addition, a protective ground connection at the terminal contact on the power supply module (identified by the letters "PE" on the terminal connection diagram) is required for proper operation of the device. The cross-section of this ground conductor must conform to applicable national standards. A minimum cross-section of 1.5 mm² is required.

If a detachable HMI is installed, a further protective conductor (ground/earth) of at least 1.5 mm² must be connected to the DHMI protective conductor terminal to link the DHMI and the main relay case; these must be located within the same substation.

All grounding connections must be low-inductance, i.e. they must be kept as short as possible.

Location

P138 for pin-terminal connection

- in case 40 TE (P138 -407)
- in case 84 TE (P138 -408)

01	P	A CH1 CH2			T 2J	X 6I 80	X 6I 80	Y 4I	V 4I 80	X 4H
02		A ETH CH2			T 2J 1V				X 6I 30	X 60
03		A Red. ETH CH2								
04										
05										
06										
07										
08										
09										
10										

01	P	A CH1 CH2			T 2J			X 6I 80	X 6I 80	X 60	X 60	X 60	X 60	X 60	X 60	X 4H	X 6I 30	X 60	V 4I 80
02		A ETH CH2			T 2J 1V			Y 4I											
03		A Red. ETH CH2																	
04																			
05																			
06																			
07																			
08																			
09																			
10																			
11																			
12																			
13																			
14																			
15																			
16																			
17																			
18																			
19																			
20																			
21																			

P138 for ring-terminal connection in case 84 TE (P138 -409)

01	P	A CH1 CH2			T 2J		X 6I 80	X 6I 80	X 60	X 60	X 60	X 60	X 4H	V 4I 80
02		A ETH CH2			T 2J 1V		Y 4I					X 6I 30	X 60	
03		A Red. ETH CH2												
04														
05														
06														
07														
08														
09														
10														
11														
12														
13														
14														
15														
16														
17														
18														
19														
20														
21														

Each of the numbered slots can be fitted with max. 1 module.

If a location diagram shows several modules for a particular slot, then these are alternatives, depending on the ordering options.

Connection

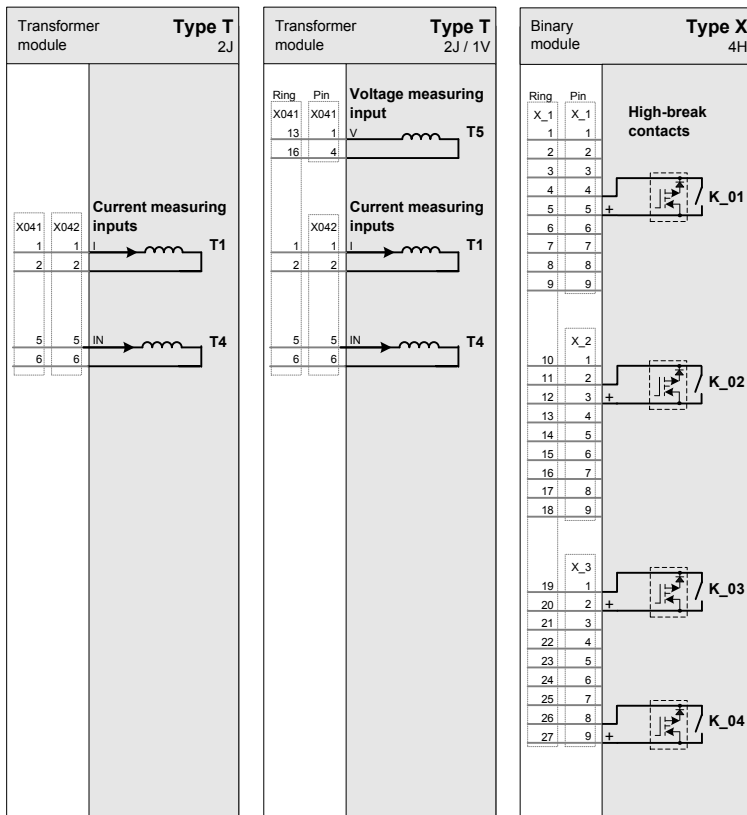

'_' is used as a wildcard for the location

See also section "Protection Conductor Terminal (PCT) / Case Grounding / Protective Earth"

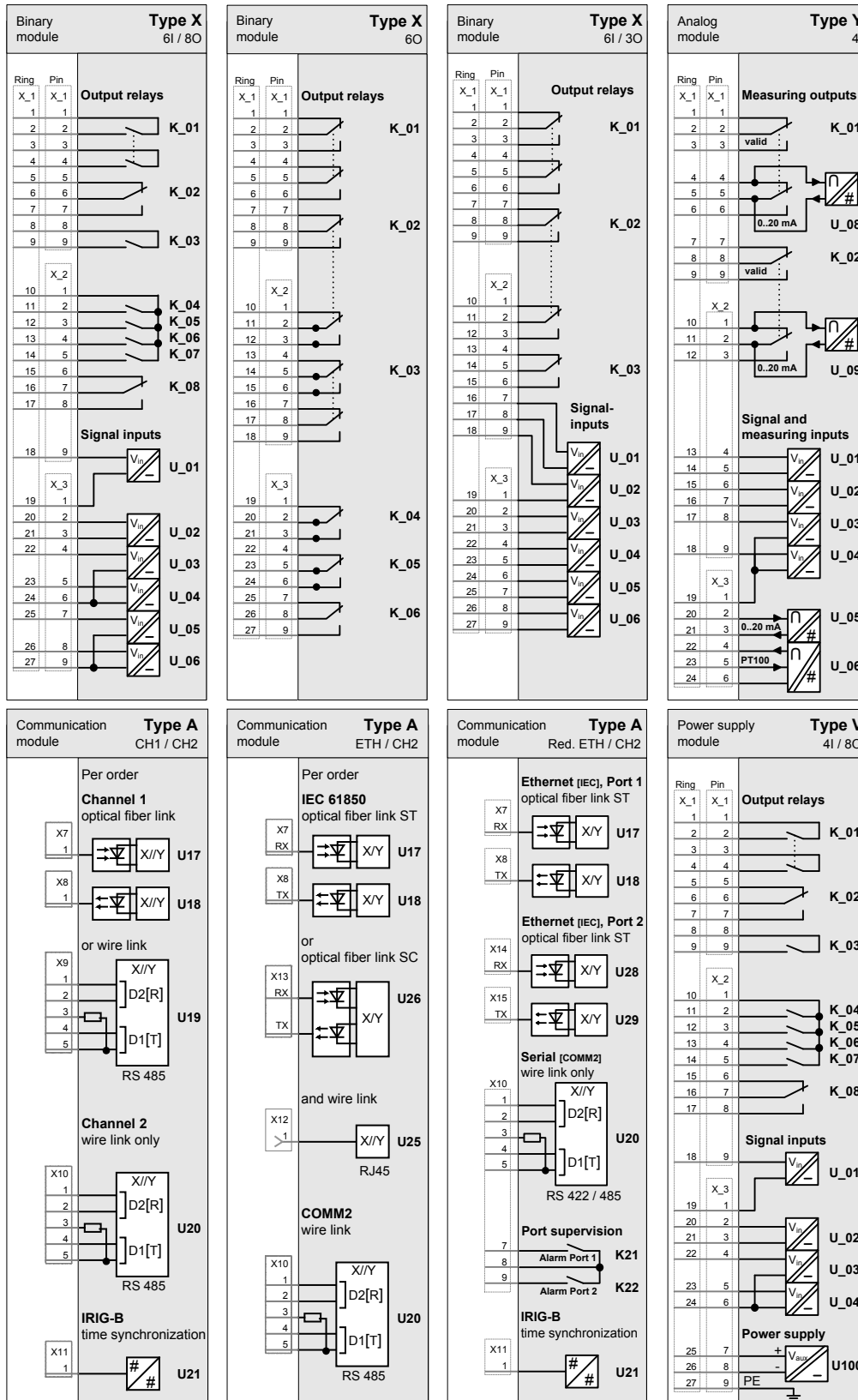

'_' is used as a wildcard for the location.

See also section "Protection Conductor Terminal (PCT) / Case Grounding / Protective Earth".



Customer Care Centre

<http://www.schneider-electric.com/cc>

Schneider Electric

35 rue Joseph Monier
92506 Rueil-Malmaison
FRANCE

Phone: +33 (0) 1 41 29 70 00
Fax: +33 (0) 1 41 29 71 00

www.schneider-electric.com

Publication: P138/EN IN/Bc3 // AFSV.10.11421 EN /// P138-303-407/-408/-409-612ff

Publishing: Schneider Electric

06/2016