

## User Manual Smart-UPS™ On-Line SRC1KXLI

### Important Safety Information

Read the instructions carefully to become familiar with the equipment before trying to install, operate, service or maintain it. The following special messages may appear throughout this manual or on the equipment to warn of potential hazards or to call attention to information that clarifies or simplifies a procedure.



The addition of this symbol to a Danger or Warning safety label indicates that an electrical hazard exists which will result in personal injury if the instructions are not followed.



This is the safety alert symbol. It is used to alert you to potential personal injury hazards. Obey all safety messages that follow this symbol to avoid possible injury or death.

### **DANGER**

**DANGER** indicates a hazardous situation which, if not avoided, will result in death or serious injury.

### **WARNING**

**WARNING** indicates a hazardous situation which, if not avoided, could result in death or serious injury.

### **CAUTION**

**CAUTION** indicates a hazardous situation which, if not avoided, could result in minor or moderate injury.

### **NOTICE**

**NOTICE** is used to address practices not related to physical injury.

# Safety and General Information

Inspect the package contents upon receipt. Notify the carrier and dealer if there is any damage.

Read the Safety Guide supplied with this unit before installing the UPS.

- Adhere to all national and local electrical codes.
- All wiring must be performed by a qualified electrician.
- Changes and modifications to this unit not expressly approved by APC could void the warranty.
- This UPS is for indoor use only.
- Do not operate this UPS in direct sunlight, in contact with fluids, or where there is excessive dust or high humidity.
- Do not operate the UPS near open windows or doors.
- Be sure the air vents on the UPS are not blocked. Allow adequate space for proper ventilation.  
**Note:** Allow 20 cm clearance on both front and rear sides of the UPS.
- Use only the mains and communication cables provided along with the UPS.
- The equipment is heavy. Always practice safe lifting techniques adequate for the weight of the equipment.

## Electrical safety

- Use tools with insulated handles.
- Do not handle any metallic connector before power has been disconnected.
- For models with a hardwired input, the connection to the branch circuit (mains) must be performed by a qualified electrician.
- Output cord connected to the UPS must not exceed 10 meters in length.
- The protective earth conductor for the UPS carries the leakage current from the load devices (computer equipment). An insulated ground conductor is to be installed as part of the branch circuit that supplies the UPS. The conductor must have the same size and insulation material as

the grounded and ungrounded branch circuit supply conductors. The conductor will typically be green, with or without a yellow stripe.

- Leakage current for a pluggable, Type A UPS may exceed 3.5 mA when a separate ground terminal is used.
- The UPS input ground conductor must be properly bonded to protective earth at the service panel.
- If the UPS input power is supplied by a separately derived system, the ground conductor must be properly bonded at the supply transformer or motor generator set.

## **Battery safety**

- Replace batteries with the same number and type of batteries as originally installed in the equipment.
- Schneider Electric uses Sealed Maintenance-Free (SMF) batteries. Under normal use and handling, there is no contact with the internal components of the battery. Over charging, over heating or other misuse of batteries can result in a discharge of battery electrolyte. Released electrolyte is toxic and may be harmful to the skin and eyes.
- CAUTION: Before installing or replacing the batteries, remove conductive jewelry such as chains, wrist watches and rings. High energy through conductive materials could cause severe burns.
- CAUTION: Do not dispose of batteries in a fire. The batteries may explode.
- CAUTION: Do not open or mutilate batteries. Released material is harmful to the skin and eyes and may be toxic.

## **Hardwire safety**

- Check that all branch circuit (mains) and low voltage (control) circuits are deenergized, and locked out before installing cables or making connections, whether in the junction box or to the UPS.
- Wiring by a qualified electrician is required.
- Check national and local codes before wiring.
- Strain relief is required for all hardwiring (supplied with select products).  
Snap in type strain reliefs are recommended.
- All openings that allow access to UPS hardwire terminals must be covered. Failure to do so may result in personal injury or equipment damage.
- Select wire size and connectors according to national and local codes.

# Radio Frequency Warning

This product has been tested and found to be category C2 device. This equipment generates, uses, and can radiate radio frequency energy and, if not installed and used in accordance with the instruction manual, may cause harmful interference to radio communications. Operation of this equipment is likely to cause radio interference with some communication devices like TV, mobiles, audio equipments, radio receivers, etc. Generally this issue can be corrected by moving the equipment a little away from the UPS, however sometimes additional measures may have to be taken at user's expense.

# Product Handling Guidelines



<18 kg  
<40 lb



18-32 kg  
40-70 lb



32-55 kg  
70-120 lb



>55 kg  
>120 lb



# Product Description

The APC by Schneider Electric Smart-UPS™ is a high performance uninterruptible power supply (UPS). The UPS helps to protect the connected electronic equipment from utility power blackouts, brownouts, sags, surges, small utility power fluctuations and large disturbances. The UPS also provides battery backup power for connected equipment until utility power returns to normal levels or the batteries are discharged.

This user manual is available on the APC by Schneider Electric Web site, [www.apc.com](http://www.apc.com).

# Package Contents

Read the Safety Guide before installing the UPS.

The packaging is recyclable; save it for reuse or dispose of it properly.

- UPS
- Literature kit containing:
  - Product documentation

## All models

Utility power cable

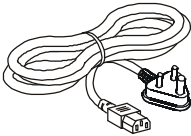

USB cable

Used to connect UPS to computer/laptop for PCBE monitoring

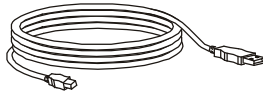

Serial communication cable

Used to upgrade the UPS firmware if and when a new version is available. Also used to monitor the UPS

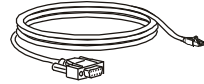

UPS management software CD



- 1 pair rack-mount bracket
- 8 screws to secure the rack-mount bracket with the USP

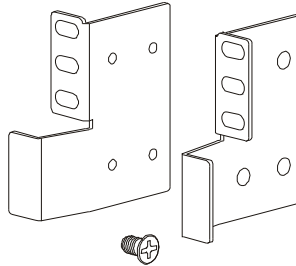

1 IEC output cable

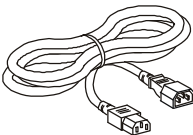

2 pairs foot

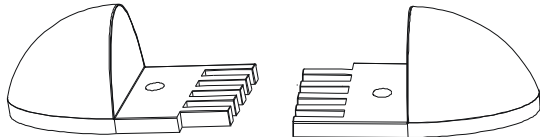

# Specifications

## Environmental specifications

### NOTICE

#### RISK OF EQUIPMENT DAMAGE

- UPS must be used indoors only.
- The installation location should be sturdy to withstand the weight of the UPS.
- Do not operate UPS where there is excessive dust or where the temperature or humidity are outside specified limits.

**Failure to follow these instructions can result in equipment damage.**

<b>Temperature</b>	<b>Operating</b>	0° to 40°C at rated load 40° to 50°C linearly derated to 80% of maximum load capacity	This unit is intended for indoor use only. Select a location sturdy enough to handle the weight.  Do not operate UPS where there is excessive dust or where the temperature or humidity are outside specified limits.
	<b>Storage</b>	-20° to 50°C	
<b>Elevation</b>	<b>Operating</b>	<ul style="list-style-type: none"> <li>• 0 - 1,000 m: normal operation</li> <li>• 1,000 - 3,000 m: The load reduces @ 1% at an increased height of every 100 m</li> <li>• &gt; 3,000 m: UPS will not work</li> </ul>	<b>Note:</b> Charge the battery modules every six months during storage.
	<b>Storage</b>	0 - 15,000 m	
<b>Humidity</b>		20 to 90% relative humidity, non-condensing	

## Physical specifications

<b>The UPS is heavy. Follow lifting guidelines.</b>	
<b>Dimensions without packaging Width x Height x Depth</b>	438 mm (17.24 in) x 88 mm (3.5 in) x 410 mm (16.14 in)
<b>Weight with packaging</b>	17.8 kg
<b>Weight without packaging</b>	15.4 kg

## Input specifications

Nominal input voltage	230 Vac Nominal
Input frequency	40 - 70 Hz
Input cable	10 A, 2.4 m
Input voltage range (100% load)	160 Vac - 280 Vac
Input voltage range (50% load)	110 Vac - 280 Vac
Input power factor (100% resistive load)	≥ 0.99 typical
Input protection	Input circuit breaker

## Output specifications

Output power capacity max.	1000 VA / 800 W
Nominal output voltage	230 Vac
Programmable voltages	200 Vac, 208 Vac, 230 Vac, 220 Vac, 240 Vac
Efficiency at rated load	88% Max.
Output voltage regulation	± 1% static
Output voltage distortion	<ul style="list-style-type: none"><li>• 3% max. for full linear load</li><li>• 6% max. for full RCD load (100% VA, 0.8 PF)</li><li>• 15% for the last 60 seconds of the backup time (with full load only for the internal battery)</li></ul>
Output frequency battery mode	50/60 Hz ± 0.5%
Output frequency AC mode	50/60 Hz ± 3 Hz
Crest factor	3:1
Waveform	Sinewave
Output connection	See “Rear Panel Features” on page 13
Bypass	Internal bypass

## Battery

### CAUTION

#### RISK OF HYDROGEN SULPHIDE GAS AND EXCESSIVE SMOKE

- Replace the battery at least every 5 years.
- Replace the battery immediately when the UPS indicates battery replacement is necessary.
- Replace battery at the end of its service life.
- Replace batteries with the same number and type of batteries as originally installed in the equipment.
- Replace the battery immediately when the UPS indicates a battery overtemperature condition, or when there is evidence of electrolyte leakage. Power off the UPS, unplug it from the AC input, and disconnect the batteries. Do not operate the UPS until the batteries have been replaced.
- Replace all battery modules (including the modules in External Battery Packs) which are older than one year, when installing additional battery packs or replacing the battery module(s).

**Failure to follow these instructions could result in equipment damage and minor or moderate injury.**

<b>Configuration</b>	Internal battery
<b>Type</b>	Sealed maintenance free (SMF) 12 V, 10 Ah
<b>Battery bank voltage</b>	36 V



# Installation

## CAUTION

### RISK OF FALLING EQUIPMENT

- The equipment is heavy.
- Ensure that the stabilizer brackets are installed when the UPS is installed in the tower orientation.

**Failure to follow these instructions can result in minor or moderate injury.**

### Rack-mount installation

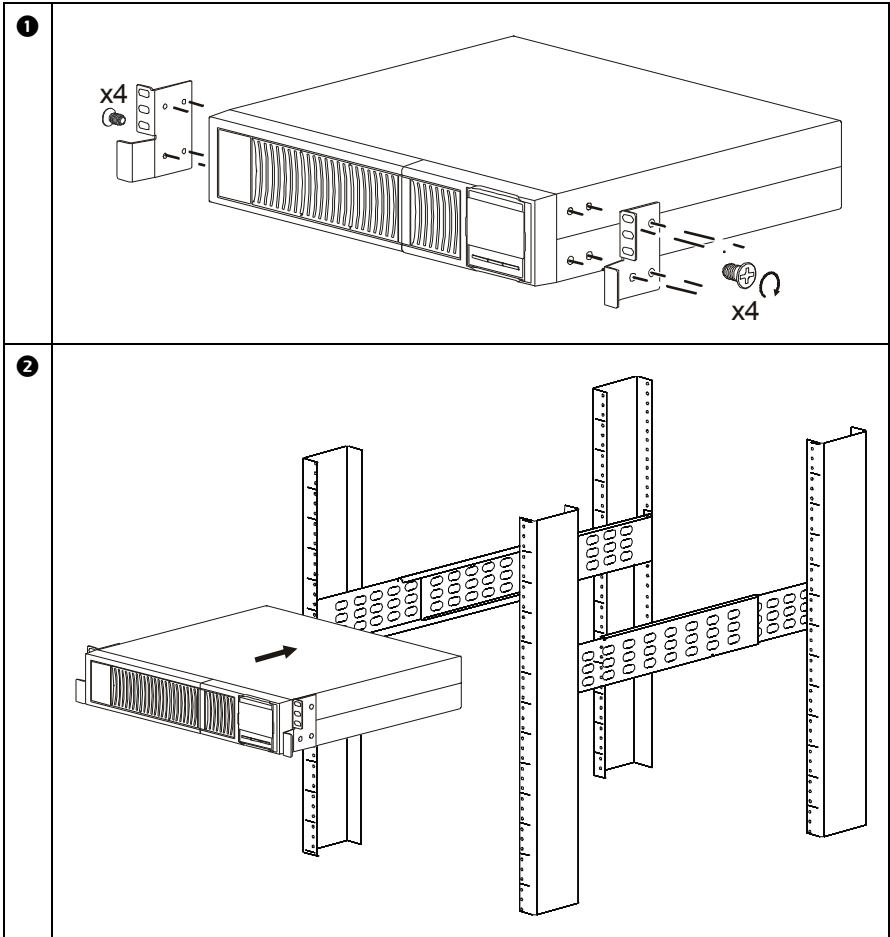

**3** Secure UPS to the rack with four screws (not supplied)

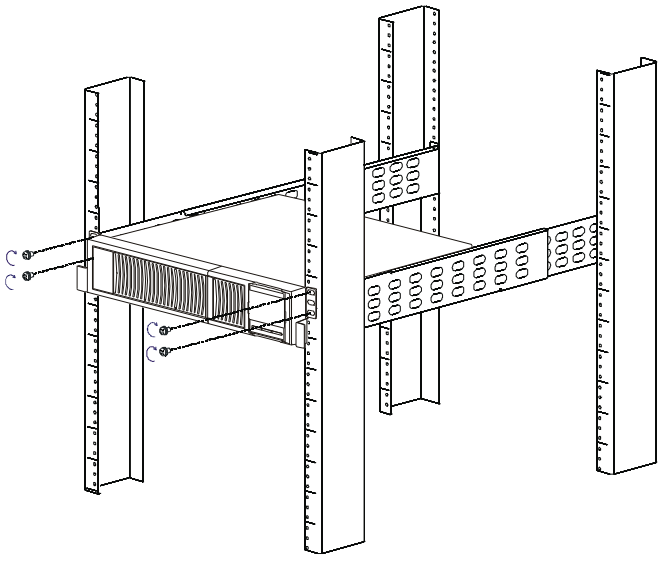

## Tower installation

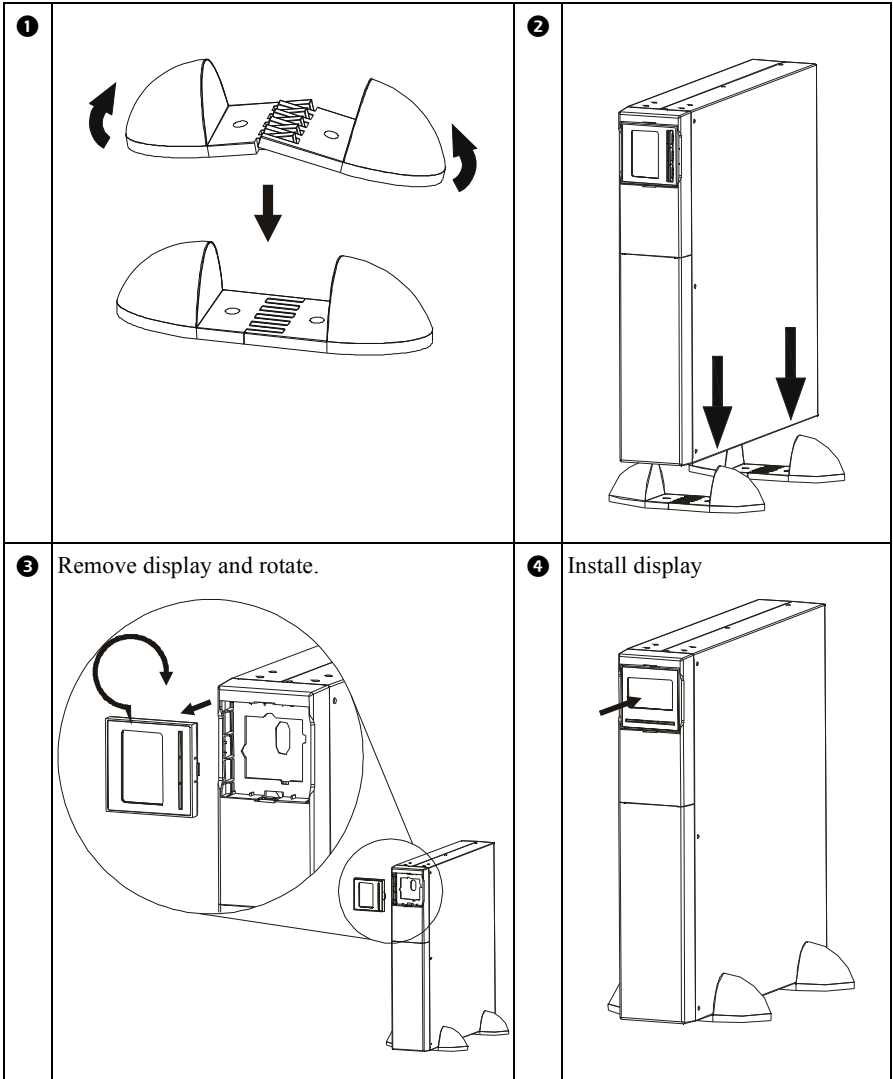

# Connect Internal Battery

- 1 Remove front panel from the left.

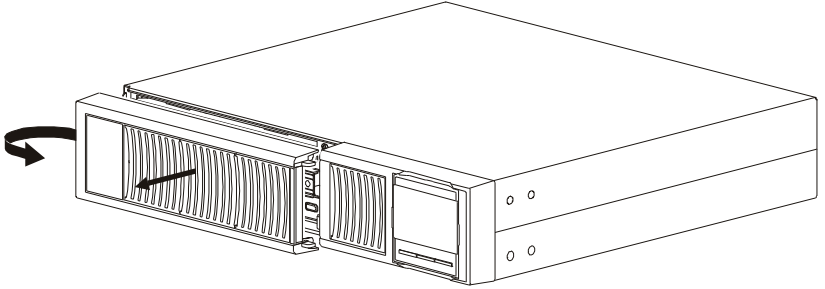

- 2 Connect the internal battery.

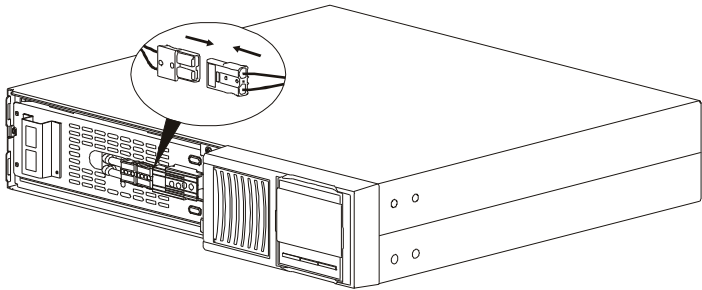

- 3 Install the front panel.

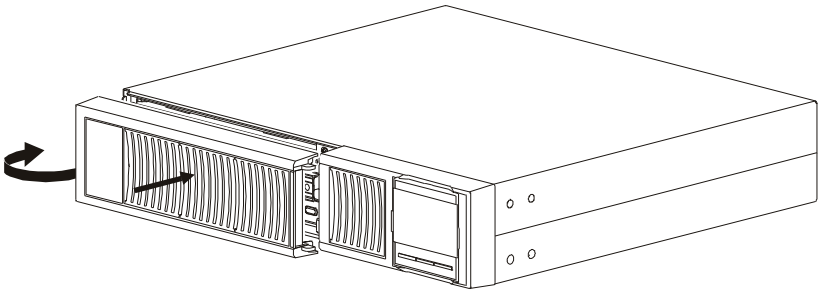

# Rear Panel Features

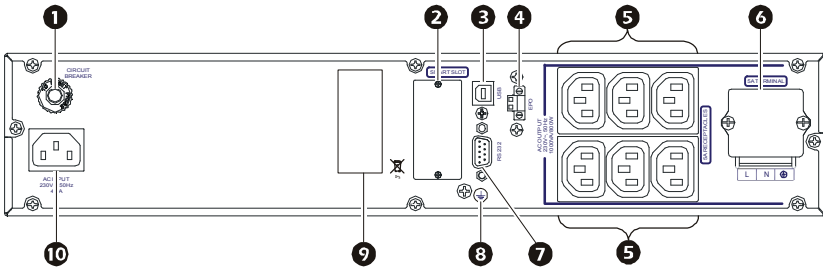

1	Input circuit breaker	6	Output terminal block
2	Smart slot	7	RS232
3	USB port	8	Ground screw
4	EPO	9	External battery connector
5	Outlets	10	AC input

## Start Up

Connect equipment, internal battery and input power to the UPS

**⚠ CAUTION**

**RISK OF ELECTRIC SHOCK**

All electrical work must be performed by a qualified electrician.  
 Turn off all power to this equipment before working on the equipment.  
 Practice lockout/tagout procedures. Do not wear jewelry when working with electrical equipment.

**Failure to follow these instructions can result in moderate injury.**

1. Connect equipment to UPS. Avoid using extension cords.
2. Connect internal battery. See “Connect Internal Battery” on page 12.
3. Connect input utility power to the UPS.
4. Switch the utility input power on. The display panel will illuminate when utility power is available.

**Note:** The UPS batteries will charge to 90% capacity in the first five hours of normal operation. Do not expect full battery runtime capability during this initial charge period.

## Start the UPS

Press the POWER ON/OFF button located on the front panel of the UPS until a beep is heard.

## Cold start the UPS

Use cold start feature to supply power to connected equipment from the UPS batteries.

Press the POWER ON/OFF button. The display panel will illuminate.

Press the POWER ON/OFF button again till a beep is heard, to supply battery power to the connected equipment.

## Install Management Software

The Smart-UPS is provided with UPS management software for unattended operating system shutdown, UPS monitoring, UPS control and energy reporting.

Install the software from the UPS management software CD.





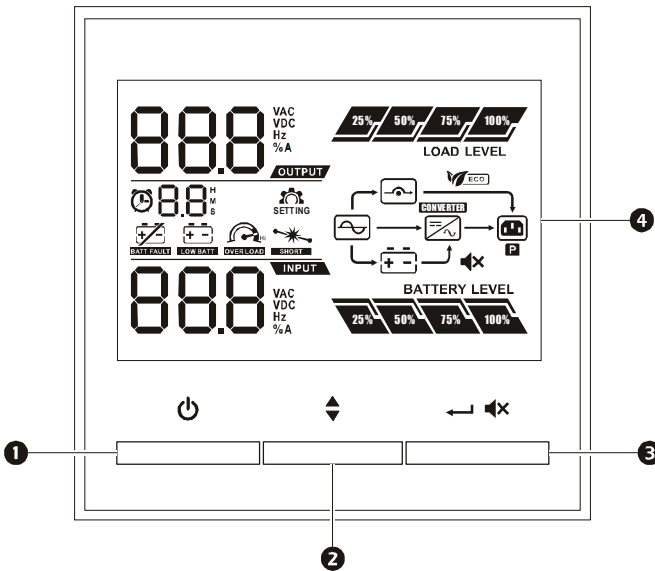

## Operation







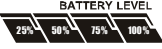



### Front display panel features



①	<b>UPS POWER ON/OFF button</b>	Press the POWER ON/OFF button to turn on/off the UPS.
②	<b>SELECT button</b>	Press the SELECT button: <ul style="list-style-type: none"> <li>• To enter the menu when UPS is in Standby mode or Bypass mode.</li> <li>• To scroll through display information screens.</li> <li>• To display next selection in UPS setting.</li> </ul>
③	<b>UPS ENTER/MUTE button</b>	Press the ENTER/MUTE button: <ul style="list-style-type: none"> <li>• To acknowledge audible alerts and suppress them temporarily while UPS is in battery mode.</li> <li>• To select a menu item/value during navigation in UPS setting.</li> </ul>
④	<b>LCD Display</b>	The display interface options are visible on this LCD screen. Press any button to activate LCD, if the display is not illuminated.
① + ②		Press POWER ON/OFF + SELECT buttons simultaneously to transfer the UPS to bypass mode when the utility power is normal. This action is ineffective when the input voltage is beyond the acceptable range.

### Front display icons

	<b>On battery runtime indicator:</b> Indicates the remaining on battery runtime as a pie chart.
	<b>On battery runtime:</b> Indicates the remaining on battery runtime in numbers. H: hours, M: minutes, S: seconds
	<b>Alert and notification information:</b> Indicates the alert and notification codes. See “Alerts and Notifications” on page 23.
	<b>Mute:</b> A cross mark in front of the icon indicates that the audible alert is disabled.
	<b>Output and battery information:</b> Indicates the output voltage and frequency. VAC: output voltage; Hz: output frequency
	<b>Battery Charge:</b> The battery charge level is indicated by the number of bar sections illuminated. When all four blocks are illuminated, the battery is fully charged. Each bar represents approximately 25% of the battery charge capacity.
	<b>Load Level:</b> The load percentage is indicated by the number of load bar sections illuminated. Each bar represents approximately 25% of the maximum load capacity.

	<p><b>Overload:</b> The equipment connected to the UPS is drawing more power than rated.</p>
	<p><b>Short circuit:</b> A short circuit has occurred at the UPS output.</p>
	<p><b>Utility normal:</b> The UPS is drawing utility power and performing double conversion to supply power to the connected equipment.</p>
	<p><b>On battery:</b> The UPS is supplying battery backup power to the connected equipment.</p>
	<p><b>Bypass:</b> The UPS is in bypass mode, sending utility power directly to connected equipment. Bypass mode operation is the result of an internal UPS event or an overload condition. Battery operation is not available while the UPS is in bypass mode. See “Alerts and Notifications” on page 23 in this manual. This icon in combination with Green Mode icon, indicates that the UPS is in green mode operation.</p>
	<p><b>Inverter operation:</b> The inverter circuit is working.</p>
	<p><b>Green Mode:</b> An illuminated icon indicates that the unit is working in Green mode. The connected equipment is receiving the utility input directly as long as the input voltage and frequency are within the configured limits.</p>
	<p><b>Output operation:</b> The illuminated icon indicates the output is working.</p>
	<p><b>Battery fault:</b> An error is detected in the battery.</p>
	<p><b>Low battery:</b> The battery is nearing its complete discharge state.</p>
	<p><b>Input and battery information:</b> Indicates the input voltage, frequency or battery voltage. VAC: Input voltage; VDC: Battery voltage, Hz: Input frequency</p>



## Front display text

Display	Description
ENR	Enable
d IS	Disable
ESC	Escape
HLS	High limit set
LLS	Low limit set
BAT	Battery



Display	Description
CF	Converter
TP	Temperature
CH	Charger
FU	Bypass frequency unstable
EE	EEPROM error
EP	EPO

## Status Indicators

Audible Alert	Condition
Continuous beeps, every second	<b>Low Battery State</b> - The battery is nearing its complete discharge state. The UPS is about to shutdown.
Two short beeps, every second	<b>Overload condition</b> - The equipment connected to the UPS is drawing more power than rated.
Two short beeps, every four second	<b>On Battery State</b> - The UPS is supplying battery backup power to the connected equipment.
Beeper continuously on	<b>Alert State</b> - UPS has detected an error. See “Alerts and Notifications” on page 23 in this manual.
Two short beeps every 10 seconds	<b>Event Bypass State</b> - UPS has detected an error. Connected equipment receives utility input power through the bypass relay.

# UPS Display Parameters

Operational data displayed in the display panel is given in the table.  
Navigate using the SELECT button.

Parameter	Units	Indicator Icons
Output voltage	Vac	
Output frequency	Hz	
Input voltage	Vac	
Input frequency	Hz	
Battery voltage	VDC	
Remaining On Battery runtime	Minutes	

## Configuration

### Configure UPS parameters

Follow these steps to configure the UPS parameters:

1. Press SELECT button to enter the UPS settings.
2. Navigate through the parameters using SELECT button.
3. Press ENTER/MUTE button to edit a parameter. The icon starts flashing to indicate it is ready for editing.
4. Press the SELECT button to navigate between the options available for the selected parameter.
5. Press ENTER/MUTE button to select the option. The flashing of icon stops after the selection.
6. Press the SELECT button to navigate between parameters.
7. Select program00 to exit the navigation menu.

### UPS settings

Configure UPS settings using the display interface. See “Configure UPS parameters” on page 18 to edit the parameters.

<b>Function</b>	<b>User Selectable Options</b>	<b>Description</b>
<b>Output voltage</b>	200, 208, 220, 230 (default), 240 Vac	Allows the user to select output voltage while the UPS is in standby mode.
<b>Frequency converter mode</b>	Enable; disable	Allows the user to set a constant output frequency of 50 Hz or 60 Hz.
<b>Output frequency</b>	BAT 50, BAT 60, CF 50, CF 60	Allows the user to select an initial frequency in battery mode and a constant output frequency in converter mode.
<b>Green mode</b>	Enable; disable	When this mode is enabled, connected equipment receives utility input power through the bypass relay as long as input voltage is within setting in program 05. If utility power input goes out of range, the load is transferred to online or battery mode. The power to the connected equipment may be interrupted up to 10 milliseconds.
<b>Green voltage range</b>	HLS: +7 V ~ +24 V of the nominal voltage (default: +12 V) LLS: -7 V ~ -24 V of the nominal voltage (default: -12 V)	Allows the user to select acceptable input voltage range for Green mode operation. HLS means upper limit. LLS means lower limit.
<b>Bypass mode</b>	Enable; disable	When this mode is enabled and acceptable input voltage range is set up, the UPS will enter bypass mode.
<b>Bypass voltage range</b>	HLS: 230 Vac ~ 264 Vac (default: 264 Vac) LLS: 170 Vac ~ 220 Vac (default: 170 Vac)	Allows the user to select acceptable input voltage range for bypass mode operation. HLS means upper limit. LLS means lower limit.
<b>On-battery runtime</b>	0 ~ 999 minutes (default: 999)	Allows the user to set up runtime. When 0 is selected, the runtime will be only 10 seconds. When 999 is selected, the runtime setting is disabled. The UPS will operate until battery is running out.
<b>Total battery Ah capacity connected</b>	7 ~ 200 (default: 10 Ah)	Allows the user to set the total Ah of the batteries connected to the UPS.

# Emergency Power Off

## NOTICE

### RISK OF EQUIPMENT DAMAGE

Do not connect the EPO interface to any circuit other than a unused circuit.

**Failure to follow these instructions can result in equipment damage.**

The Emergency Power Off (EPO) option is a feature that will immediately remove power to all connected equipment. When EPO button is pushed, all connected equipment will immediately turn off.

**Adhere to all national and local electrical codes. Wiring must be performed by a qualified electrician.**

The EPO switch is internally powered by the UPS for use with non-powered switches or potential free contacts.

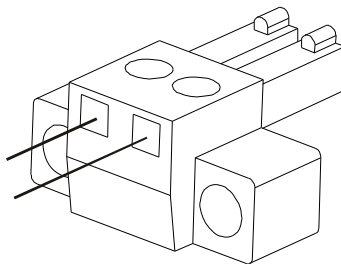

**The EPO interface is a Safety Extra Low Voltage (SELV) circuit. Connect it only to other SELV circuits. The EPO interface monitors circuits that have no determined voltage potential. Such closure circuits may be provided by a switch or relay properly isolated from the utility. To avoid damage to the UPS, do not connect the EPO interface to any circuit other than a unused circuit.**

Use one of the following cable types to connect the UPS to the EPO switch.

- CL2: Class 2 cable for general use.
- CL2P: Plenum cable for use in ducts, plenums, and other spaces used for environmental air.
- CL2R: Riser cable for use in a vertical run in a floor-to-floor shaft.
- CLEX: Limited use cable for use in dwellings and for use in raceways.

# Troubleshooting

See “Rear Panel Features” on page 13 and “Front display panel features” on page 14 for the locations and graphical representations of the buttons and LEDs referred to in this table.





Problem and/or Possible Cause	Solution
<b>UPS will not turn on when utility input is available or there is no power output</b>	
The UPS is not turned on.	Press the POWER ON/OFF button to turn on the UPS.
The UPS is not connected to utility power supply.	Check that the power cable from the UPS to the utility power supply is securely connected at both ends. See “Start Up” on page 13 in this manual.
Input thermal circuit breaker on the UPS is tripped.	Press the input thermal circuit breaker reset button in the rear panel.
<b>The UPS is operating on battery, while connected to the input utility power</b>	
There is high, low, or distorted input voltage or input frequency is out of range.	Connect the UPS to a different outlet on a different circuit. Test the utility input power to ensure the unit is receiving input power. If display is on, navigate and check the input voltage and frequency.
<b>UPS, when connected to battery, is not supplying power to the connected equipment</b>	
The UPS is not turned on.	If the UPS has shutdown (the display is not on), follow the procedure “Cold start the UPS” on page 14.
The battery is not connected.	Connect battery to the UPS. See “Connect Internal Battery” on page 12 in this manual.
Low battery cut off. UPS may have discharged the battery due to utility power outage and turned the output off due to low battery condition.	Wait for the utility power to return and charge the battery.
<b>UPS emits an audible beeping sound at long intervals</b>	
The UPS is operating normally when running on battery.	UPS has detected an error. See “Alerts and Notifications” on page 23 in this manual.

Problem and/or Possible Cause	Solution
<b>UPS is not providing expected backup time</b>	
The UPS battery is discharged due to a recent power outage.	The batteries require recharging after extended outages. Batteries can wear faster when put into service without proper recharging or when operated at elevated temperatures.
The battery is near the end of its service life.	If the battery is near the end of its service life, consider replacing the battery, even if the replace battery indicator is not illuminated. See “Start Up” on page 13 in this manual.
<b>An error code is displayed and alarm is heard continuously. UPS internal fault is detected.</b>	
The connected equipment is powered by the AC power through the UPS bypass mode.	Contact APC by Schneider Electric.
The UPS is not supplying power to the connected equipment	Contact APC by Schneider Electric.







# Alerts and Notifications

UPS displays a flashing icon and a numeric code when it detects an error.

## Alerts

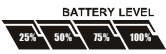
Display code	Icon	Description	Solution
01	NA	Bus start failure.	Contact APC by Schneider Electric
02	NA	Bus voltage is too high.	
03	NA	Bus voltage is too low.	
04	NA	Bus voltage is unbalanced.	
11	NA	Inverter soft start failure.	
12	NA	Inverter voltage is too high.	
13	NA	Inverter voltage is too low.	
14		UPS has experienced a short circuit at the output. Unit will try to auto-recover from this condition.	
27		Battery voltage is too high.	Contact APC by Schneider Electric
28		Battery voltage is too low.	
41		Temperature of the unit is too high.	Disconnect nonessential equipment from the UPS to reduce the UPS load. Ensure that ambient temperature is within limits. Ensure that adequate clearance is maintained.
43		UPS is experiencing a heavy overload condition.	Disconnect nonessential equipment from the UPS to eliminate the overload condition.
45		UPS has detected a charger error.	Verify if there is any short circuit at the UPS battery terminal. Press POWER ON/OFF to start the UPS.
Contact APC by Schneider Electric for all other alert codes.			

## Notifications

Display icon	Description	Solution
	UPS is experiencing an overload condition.	Disconnect nonessential equipment from the UPS to eliminate the overload condition.
	The battery is nearing its complete discharge state.	Shut down the UPS and recharge the battery.
	Battery is not connected.	Connect battery to the UPS. See “Start Up” on page 13 in this manual.
	Overcharge.	Contact APC by Schneider Electric
	Input voltage is out of bypass voltage range.	Ensure the utility power supply is in the bypass range.
	Bypass frequency is unstable.	Contact APC by Schneider Electric
	EEPROM	Contact APC by Schneider Electric



## Transport

1. Shut down and disconnect all connected equipment.
2. Disconnect the unit from mains power.
3. Disconnect all internal and external batteries (if applicable).
4. Follow the shipping instructions outlined in the *Service* section of this manual.

## Service

If the unit requires service, do not return it to the dealer. Follow these steps:

1. Review the *Troubleshooting* section of the manual to eliminate common problems.
2. If the problem persists, contact APC by Schneider Electric Customer Support through the APC by Schneider Electric web site, **www.apc.com**.
  - a. Note the model number and serial number and the date of purchase. The model and serial numbers are located on the rear panel of the unit.
  - b. Call Customer Support. A technician will attempt to solve the problem over the phone. If this is not possible, the technician will issue a Returned Material Authorization Number (RMA#).
  - c. If the unit is under warranty, the repairs are free.
  - d. Service procedures and returns may vary internationally. For country specific instructions refer to the APC by Schneider Electric website, **www.apc.com**.
3. Pack the unit properly to avoid damage in transit. Never use foam beads for packaging.  
Damage sustained in transit is not covered under warranty.  
**Note:** Before shipping the UPS, disconnect the internal battery connector.
4. Write the RMA# provided by Customer Support on the outside of the package.
5. Return the unit by insured, prepaid carrier to the address provided by Customer Support.

## Limited Factory Warranty

Schneider Electric IT Corporation (SEIT), warrants its products to be free from defects in materials and workmanship for a period of two (2) years, including the batteries inside the unit, from the date of purchase. The SEIT obligation under this warranty is limited to repairing or replacing, at its own sole option, any such defective products. Repair or replacement of a defective product or part thereof does not extend the original warranty period.

This warranty applies only to the original purchaser who must have properly registered the product within 10 days of purchase. Products may be registered online at [warranty.apc.com](http://warranty.apc.com).

SEIT shall not be liable under the warranty if its testing and examination disclose that the alleged defect in the product does not exist or was caused by end user or any third person misuse, negligence, improper installation, testing, operation or use of the product contrary to SEIT recommendations of specifications. Further, SEIT shall not be liable for defects resulting from: 1) unauthorized attempts to repair or modify the product, 2) incorrect or inadequate electrical voltage or connection, 3) inappropriate on site operation conditions, 4) Acts of God, 5) exposure to the elements, or 6) theft. In no event shall SEIT have any liability under this warranty for any product where the serial number has been altered, defaced, or removed.

**EXCEPT AS SET FORTH ABOVE, THERE ARE NO WARRANTIES, EXPRESS OR IMPLIED, BY OPERATION OF LAW OR OTHERWISE, APPLICABLE TO PRODUCTS SOLD, SERVICED OR FURNISHED UNDER THIS AGREEMENT OR IN CONNECTION HEREWITH.**

**SEIT DISCLAIMS ALL IMPLIED WARRANTIES OF MERCHANTABILITY, SATISFACTION AND FITNESS FOR A PARTICULAR PURPOSE.**

**SEIT EXPRESS WARRANTIES WILL NOT BE ENLARGED, DIMINISHED, OR AFFECTED BY AND NO OBLIGATION OR LIABILITY WILL ARISE OUT OF, SEIT RENDERING OF TECHNICAL OR OTHER ADVICE OR SERVICE IN CONNECTION WITH THE PRODUCTS.**

**THE FOREGOING WARRANTIES AND REMEDIES ARE EXCLUSIVE AND IN LIEU OF ALL OTHER WARRANTIES AND REMEDIES. THE WARRANTIES SET FORTH ABOVE CONSTITUTE SEIT'S SOLE LIABILITY AND PURCHASER EXCLUSIVE REMEDY FOR ANY BREACH OF SUCH WARRANTIES. SEIT WARRANTIES EXTEND ONLY TO ORIGINAL PURCHASER AND ARE NOT EXTENDED TO ANY THIRD PARTIES.**

**IN NO EVENT SHALL SEIT, ITS OFFICERS, DIRECTORS, AFFILIATES OR EMPLOYEES BE LIABLE FOR ANY FORM OF INDIRECT, SPECIAL, CONSEQUENTIAL OR PUNITIVE DAMAGES, ARISING OUT OF THE USE, SERVICE OR INSTALLATION OF THE PRODUCTS, WHETHER SUCH DAMAGES ARISE IN CONTRACT OR TORT, IRRESPECTIVE OF FAULT, NEGLIGENCE OR STRICT LIABILITY OR WHETHER SEIT HAS BEEN ADVISED IN ADVANCE OF THE POSSIBILITY OF SUCH DAMAGES. SPECIFICALLY, SEIT IS NOT LIABLE FOR ANY COSTS, SUCH AS LOST PROFITS OR REVENUE, WHETHER DIRECT OR INDIRECT, LOSS OF EQUIPMENT, LOSS OF USE OF EQUIPMENT, LOSS OF SOFTWARE, LOSS OF DATA, COSTS OF SUBSTITUANTS, CLAIMS BY THIRD PARTIES, OR OTHERWISE.**

**NOTHING IN THIS LIMITED WARRANTY SHALL SEEK TO EXCLUDE OR LIMIT SEIT LIABILITY FOR DEATH OR PERSONAL INJURY RESULTING FROM ITS NEGLIGENCE OR ITS FRAUDULENT MISREPRESENTATION OF TO THE EXTENT THAT IT CANNOT BE EXCLUDED OR LIMITED BY APPLICABLE LAW.**

To obtain service under warranty you must obtain a Returned Material Authorization (RMA) number from customer support. Customers with warranty claims issues may access the SEIT worldwide customer support network through the APC by Schneider Electric web site: [www.apc.com](http://www.apc.com). Select your country from the country selection drop down menu. Open the Support tab at the top of the web page to obtain information for customer support in your region. Products must be returned with transportation charges prepaid and must be accompanied by a brief description of the problem encountered and proof of date and place of purchase.

# APC by Schneider Electric Worldwide Customer Support

Customer support for this or any other APC by Schneider Electric product is available at no charge in any of the following ways:

- Visit the APC by Schneider Electric web site to access documents in the APC by Schneider Electric Knowledge Base and to submit customer support requests.
  - **www.apc.com** (Corporate Headquarters)  
Connect to localized APC by Schneider Electric web sites for specific countries, each of which provides customer support information.
  - **www.apc.com/support/**  
Global support searching APC by Schneider Electric Knowledge Base and using e-support.
- Contact the APC by Schneider Electric Customer Support Center by telephone or e-mail.
  - Local, country specific centers: go to **www.apc.com/support/contact** for contact information.
  - For information on how to obtain local customer support, contact the APC by Schneider Electric representative or other distributor from whom you purchased your APC by Schneider Electric product.