

# SE7600F Series

## RTU Terminal Equipment Controller with Modulating Heat

### Installation Guide For Commercial HVAC Applications



#### CONTENTS

<b>Installation</b>	<b>2</b>
Location	2
Installation	2
<b>Operation Overview</b>	<b>3</b>
Features overview	3
<b>Model Chart</b>	<b>3</b>
Network ready	4
<b>Terminal, Identification and Function</b>	<b>4</b>
Screw terminal arrangement and wiring	4
Main outputs wiring	4
<b>Typical Applications</b>	<b>5</b>
Remote sensor accessories	5
<b>Configuring and Status Display Instructions</b>	<b>7</b>
Status display	7
<b>User interface</b>	<b>8</b>
User configuring instructions menu	8
Local keypad interface	8
<b>Installer Configuration Parameter Menu</b>	<b>13</b>
<b>Discharge Air Control</b>	<b>20</b>
<b>Specifications</b>	<b>21</b>
<b>Drawing &amp; Dimensions</b>	<b>22</b>

## INSTALLATION

### Inspection

- Remove the security screw on the bottom of the Terminal Equipment Controller cover.
- Open the unit by pulling on the bottom side of Terminal Equipment Controller (Figure-1).
- Remove the wiring terminals from the sticker.
- Please read the FCC ID and IC label installed in the cover upon removal of the cover for the wireless products.

### Location

- Do not install on an outside wall.
- Install away from any direct heat source.
- Do not install near an air discharge grill.
- Do not locate in direct sun radiation.
- Nothing should restrict vertical air circulation to the Terminal Equipment Controller.

### Installation

1. Swing open the Terminal Equipment Controller PCB to the left by pressing the two PCB retaining tabs (Figure-2).
2. Pull the cables 6" out from the wall.
3. The wall surface must be flat and clean.
4. Insert the cable into the central hole of the base.
5. Align the base and mark the location of the two mounting holes on the wall. Install the proper side of the base upward.
6. Install the screw anchors in the wall.
7. Insert screws in the mounting holes on each side of the base (Figure-2).
8. Gently swing back the circuit board on the base and push on it until the tabs lock it.
9. Strip each wire 1/4 inch from the end.
10. Insert each wire according to the wiring diagram.
11. Gently push excess wiring back into the hole in the base.
12. Reinstall the wiring terminals in their correct locations (Figure-3).
13. Reinstall the cover (top side first) and gently push any extra wire length back into the hole in the wall.
14. Install the security screw.

### Installation

If replacing an existing Terminal Equipment Controller, label the wires before removal of the Terminal Equipment Controller.

Electronic controls are static sensitive devices. Discharge yourself properly before manipulating and installing the Terminal Equipment Controller.

A short circuit or wrong wiring may permanently damage the Terminal Equipment Controller or the equipment.

All SE7000 series Terminal Equipment Controllers are designed for use as operating controls only and are not safety devices. These instruments have undergone rigorous tests and verification prior to shipping to ensure proper and reliable operation in the field. Whenever a control failure could lead to personal injury and/or loss of property, it becomes the responsibility of the user / installer / electrical system designer to incorporate safety devices (such as relays, flow switch, thermal protections, etc...) and/ or an alarm system to protect the entire system against such catastrophic failures. Tampering with the devices or unintended application of the devices will result in a void of warranty.

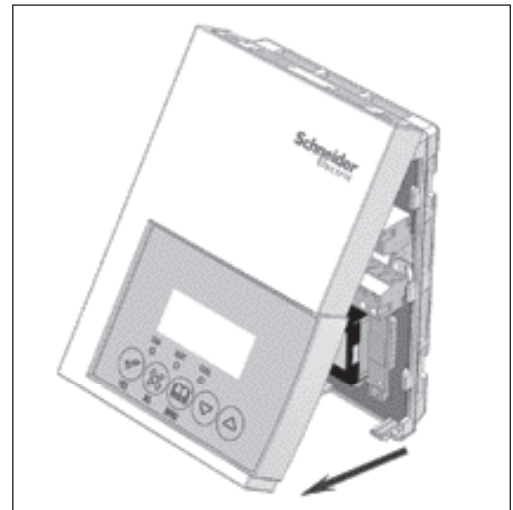

Figure-1 Opening the Cover

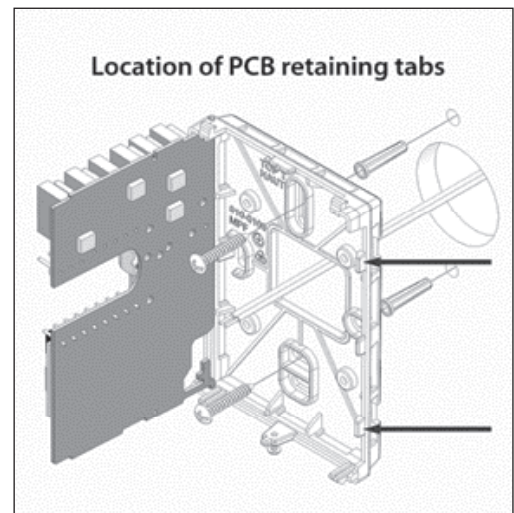

Figure-2 Opening the PCB

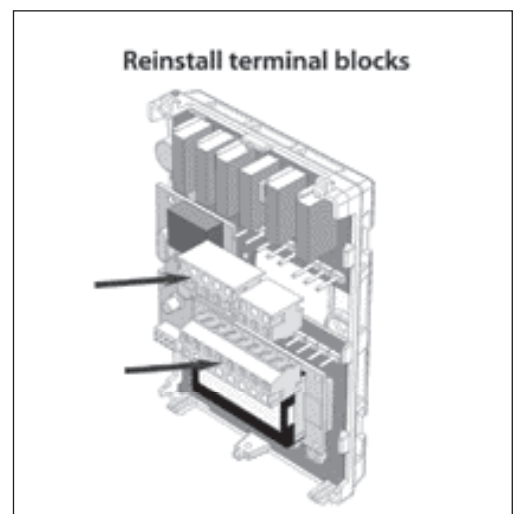

Figure-3 Terminal Block Reinstall

## THEORY OF OPERATION

The SE76X6F uses a Schneider Electric proprietary adaptive logic algorithm to control the space temperature. This algorithm controls the heating and air conditioning system to minimize overshoot while still providing comfort. It provides exceptional accuracy due to its unique PI time proportioning control algorithm, which virtually eliminates the temperature offset associated with traditional, differential-based, on-off Terminal Equipment Controllers. Note the comparison in Figure-4.

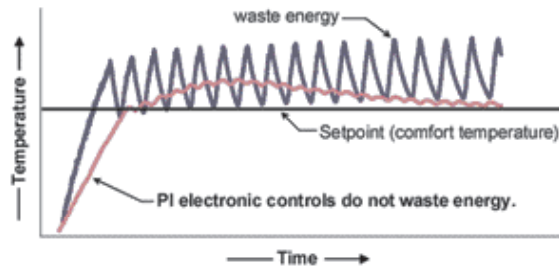

Figure-4 On-Off Mechanical vs PI Electronic Control

## FEATURES OVERVIEW

- 7 day schedule models, 2 or 4 events
- Gas, oil or electric system compatibility for all types of applications
- Remote indoor averaging sensing capability
- Temperature averaging with 2, 3, 4, 9 or 16 sensors
- Remote outdoor sensing capability for added flexibility
  - System mode heating and cooling lock out
- Remote discharge air sensor input for monitoring and control purpose.
  - System efficiency feedback
  - Discharge high limit heating lockout
  - Discharge low limit cooling lockout.
  - Minimum supply air temperature
  - Remote return air sensor input that replaces internal on board sensor
- Automatic smart fan operation saves energy during unoccupied periods.
- Non volatile EEPROM memory prevents loss of parameters during power shortage.
- Configurable SPST output relay on scheduling models for lighting, exhaust fan or fresh air control.
- 6 hour typical reserve time for clock in case of power loss.

## Easy configuration and self-binding operation

- Easy configuration without using any special software or additional tools.
- Can be used as stand-alone or with BACnet™ MS-TP supervision controller for monitoring purposes.
- Truly scalable in terms of supported number of zones and RTU units.
- Password protected configuration menu and lockable keypads for security.
- 2 configurable digital inputs for added flexibility. Each input can be configured as the following:

**None:** No function will be associated with the input

**Service:** A backlit flashing Service alarm is displayed on the Terminal Equipment Controller LCD screen when the input is energized. It can be tied in to the AC unit control card, which provides an alarm in case of malfunction.

**Filter:** A backlit flashing Filter alarm is displayed on the Terminal Equipment Controller LCD screen when the input is energized. It can be tied to a differential pressure switch that monitor filters

**Rem NSB:** Remote NSB timer clock input. Will disable the internal scheduling of the Terminal Equipment Controller. The scheduling will now be set as per the digital input. The menu part related to scheduling is disabled and no longer accessible. It provides low cost setback operation via occupancy sensor or from a dry contact

**RemOVR:** Temporary occupancy contact. Disables all override menu function of the Terminal Equipment Controller. The override function is now controlled by a manual remote, momentarily closed contact. When configured in this mode, the input operates in a toggle mode. With this function enabled it is now possible to toggle between unoccupied & occupied setpoints for the amount of time set by parameter (TOccTime) temporary occupancy time.

## MODEL CHART

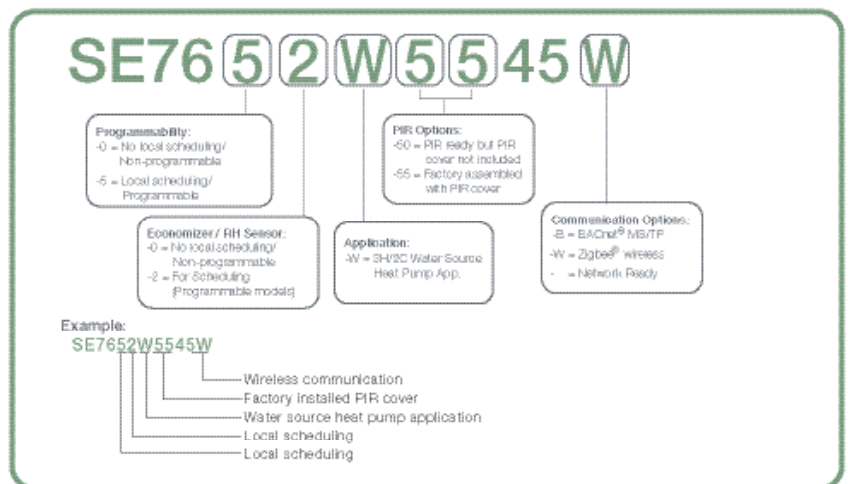

## NETWORK READY

- All Schneider Electric SE7600 series Terminal Equipment Controllers (TEC) are designed for stand-alone (Network Ready) operation.
- They can be fully integrated into your choice of automation systems using the available communication adapter options.
- If required, stand-alone (Network Ready) TECs can be field retrofitted with the following communication adapters:
  - VCM7000V5045W wireless Zigbee® communication adapter.
  - VCM7600V5045B BACnet® MS-TP® communication adapter.

## TERMINAL IDENTIFICATION

Terminal Use	Terminal Identification	Description
1 – Y2 2 <sup>nd</sup> cooling	Y2	Second cooling stage output.
2 – Y1 1 <sup>st</sup> cool	Y1	First cooling stage output.
3 – G Fan	G	Fan output.
4 – RC 24VAC hot	RC	Power supply of thermostat, hot side.
5 – C 24VAC com	C	Power supply of thermostat, common side.
9 – AO analog heat	AO	Analog 0 – 10 VDC heating output.
10 – Auxiliary output	AUX	Auxiliary output used to disable economizer minimum position or control lighting during unoccupied periods.
11 – DI 1	DI 1	Configurable extra digital input. See parameter section for more information.
12 – DI 2	DI 2	Configurable extra digital input. See parameter section for more information.
13 – RS	RS	Remote temperature sensor input.
14 - Scom	Scom	Reference input for DI 1, RS, OS & DS.
15 - OS	OS	Outside air temperature sensor input.
16 - DS	MS	Discharge air temperature sensor input.

## MAIN OUTPUTS WIRING

### Screw Terminal Arrangement

SE76XXF Controller Terminals

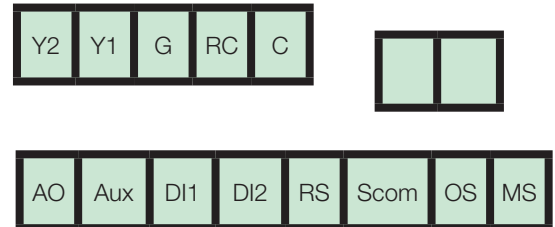

### Wiring Notes

#### Note 1

If the same power source is used for the heating stages, install a jumper across terminals RC and RH. The maximum current is 2.0 amps.

#### Note 2

If the auxiliary output is used to toggle occupancy of the electronic control card inside the equipment, configure the relay parameter (Aux cont) to the N.O. setting. A second relay can be added for additional functionality of the occupancy output.

#### Note 3

Economizer output uses a half-bridge rectifier. Reference of the control signal is the Common (Terminal C) of the power supply of the Terminal Equipment Controller.

#### Note 4

Electromechanical contacts are to be used with the digital inputs. Electronic triacs cannot be used as a means of switching for the input. The switched leg to the input for the input to activate is the Common (Terminal C).

#### Note 5

The transformer of the unit provides power to the Terminal Equipment Controller and the additional loads that will be wired to the Terminal Equipment Controller.

TYPICAL APPLICATIONS

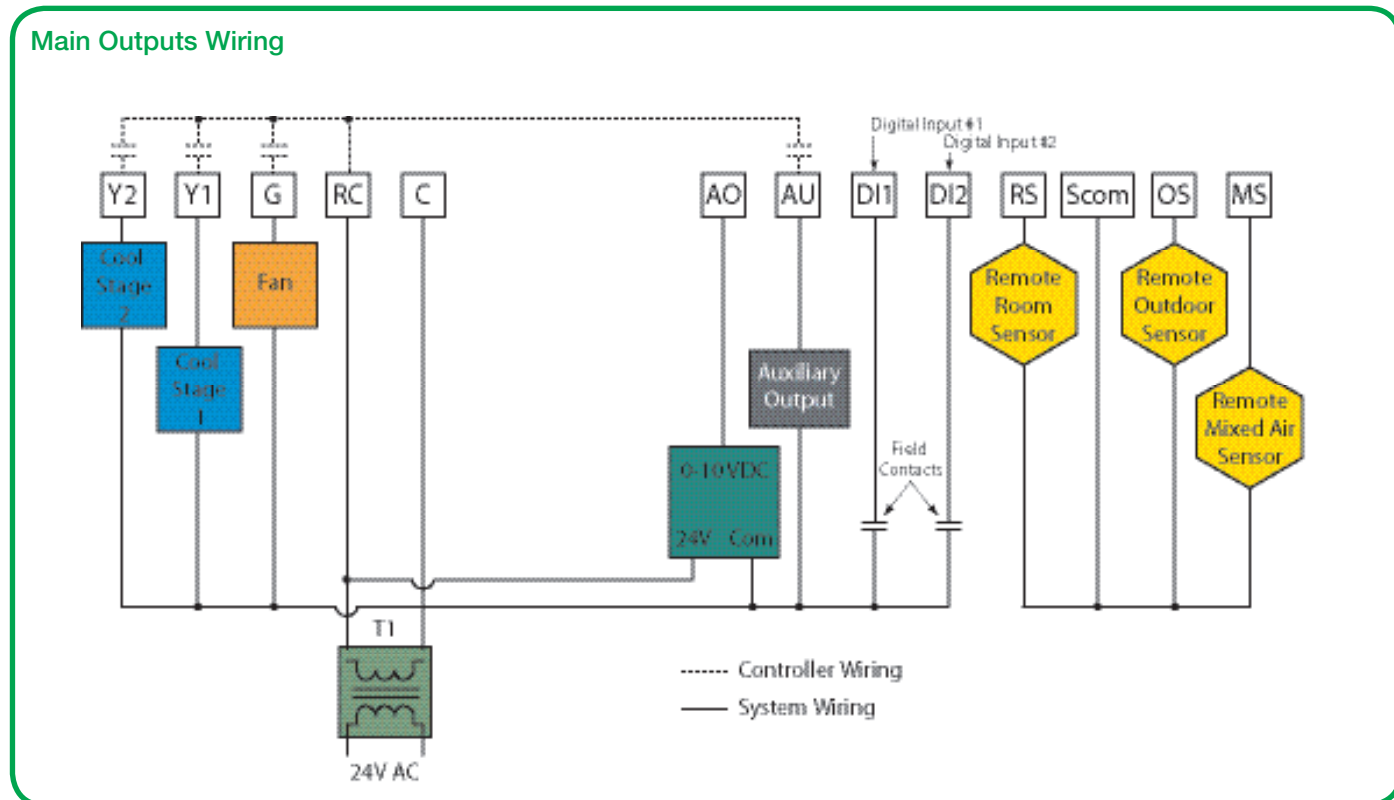

REMOTE SENSOR ACCESSORIES

Applicable Models

Model	Description	Application	Picture
SE3010W1045	Room sensor	<ul style="list-style-type: none"> <li>Remote room sensing</li> <li>3 thermistors with 2 dip switches are provided with each sensor for various averaging combinations</li> </ul>	
SE3020W1045	Room sensor with temporary override key and occupancy LED	<ul style="list-style-type: none"> <li>Remote room sensing with override key and occupancy LED</li> <li>3 thermistors with 2 dip switches are provided with each sensor for various averaging combinations</li> </ul>	

REMOTE TEMPERATURE SENSORS

Single Sensor

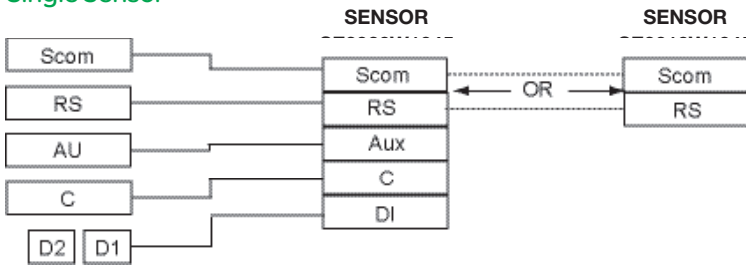

Two Sensor Averaging Application

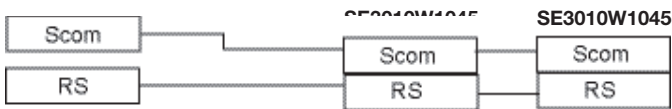
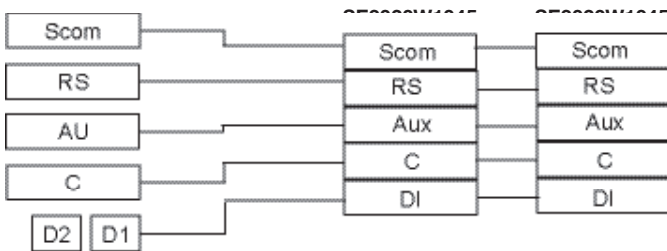
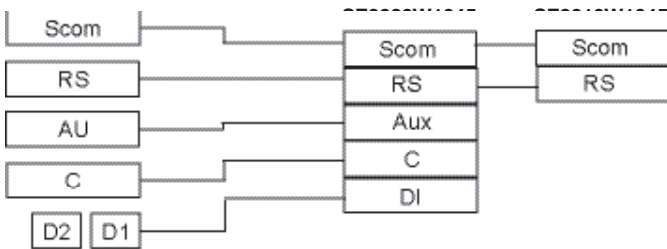

Three Sensor Application

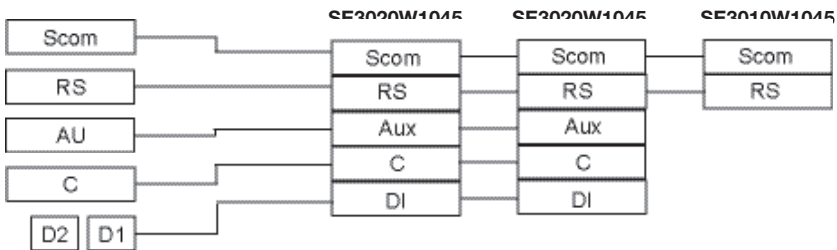
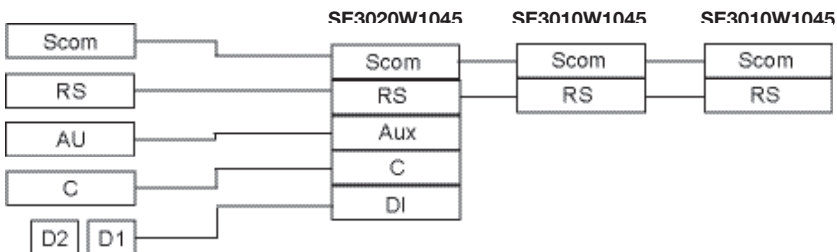

Temp. Sensor DIP Switch Settings

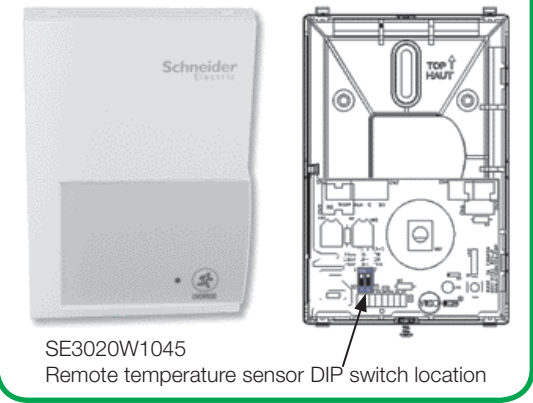
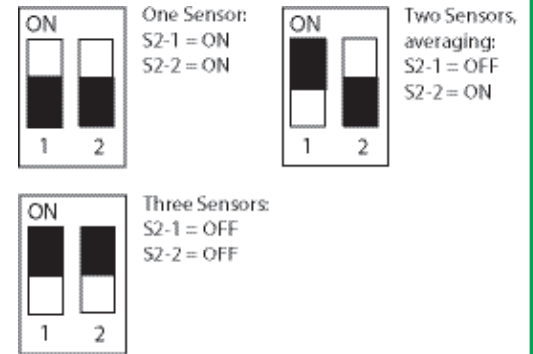

Temperature vs. resistance chart for 10 Kohm NTC thermistor

°C	°F	Kohm
-40	-40	324.3197
-35	-31	234.4009
-30	-22	171.3474
-25	-13	126.6109
-20	-4	94.5149
-15	5	71.2430
-10	14	54.1988
-5	23	41.5956
0	32	32.1910
5	41	25.1119
10	50	19.7390
15	59	15.6286
20	68	12.4601
25	77	10.0000
30	86	8.0694
35	95	6.5499
40	104	5.3467
45	113	4.3881
50	122	3.6202
55	131	3.0016

(R<sub>25°C</sub> = 10KΩ±3%, B25/85°C = 3975K±1.5%)

## CONFIGURING / STATUS DISPLAY INSTRUCTIONS

### Status Display

The TEC (Terminal Equipment Controller) features a two-line, eight-character display. A low-level, always-active backlight can be seen only at night.

Left unattended, the TEC shows an auto scrolling display that indicates the status of the system. Each item is scrolled one by one with the back lighting in low level mode. Pressing any key will cause the back light to increase to high level.

Manual scrolling of each menu item is achieved by pressing the YES (scroll) key repetitively. The last item viewed will be shown on the display for 30 seconds before returning to automatic scrolling. Temperature is automatically updated when scrolling is held.



	When any of the fan speeds are ON, the FAN LED will illuminate.
	When heating & reheat is ON, the HEAT LED will illuminate.
	When cooling is ON, the COOL LED will illuminate.

### Outdoor air temperature

- The outdoor air temperature display is only enabled when the outdoor air temperature sensor is connected.
- A maximum range status display of 50 °C (122 °F) indicates a shorted sensor. Associated functions, such as mode lockouts and economizer function are automatically disabled.
- A minimum range status -40 °C (-40 °F) indicates an open-circuited sensor or a sensor not connected. Associated functions, such as mode lockouts and economizer function are automatically disabled.

### Sequence of auto-scroll status display

CLOCK STATUS	SYSTEM MODE	SCHEDULE STATUS	OUTDOOR TEMP.	ALARMS
Monday 12:00 AM	Sys Mode Off	Occupied	Outdoor x.x °C or °F	Service
	Sys Mode Auto	Unoccupied		DAS Alarm
	Sys Mode Cool	Override		SetClock
	Sys Mode Heat			Filter
				Fan lock
				Frost ON

### Alarms

- If alarms are detected, they will be displayed automatically at the end of the status display scroll.
- During an alarm message display, the back lit screen will light up at the same time as the message and shut off during the rest of the status display.
- Two alarms maximum can appear at any given time. The priority for the alarms is as follows:

<b>Frost ON</b>	Indicates that the heating is energized by the low limit frost protection room temperature setpoint 5.6 °C (42 °F).
<b>SetClock</b>	Indicates that the clock needs to be reset. There has been a power failure which has lasted longer than 6 hours.
<b>Service</b>	Indicates that there is a service alarm as per one of the configurable digital inputs (DI1 or DI2).
<b>Filter</b>	Indicates that the filters are dirty as per one of the configurable digital inputs (DI1 or DI2).
<b>Fan lock</b>	Indicates that the heating and cooling action are locked out due to a fan malfunction.
<b>DAS Alarm</b>	Indicates that the discharge air temperature is either too low or too high.

## USER INTERFACE



### User Configuring Instructions Menu

The SE76X6 series of Terminal Equipment Controller feature an intuitive, menu-driven, back-lit LCD display that walks users through the configuring steps, making the configuring process extremely simple. This menu is typically accessed by the user to set the parameters such as temperature and time events, system mode, fan mode, etc...

It is possible to bring up the user menu at any time by pressing the MENU key. The status display automatically resumes after exiting the user-configuring menu.

If the user pauses at any given time during configuring, Auto Help text is displayed to help and guide the user through the usage and configuring of the Terminal Equipment Controller.

Example: Press the YES key to change the cooling temperature setpoint. Use the Up/Down Arrow keys to adjust the cooling setpoint.

Each of the sections in the menu is accessed and configured using 5 keys on the Terminal Equipment Controller cover.

When left unattended for 45 seconds, the display will resume automatic status display scrolling.

To turn on the back light, press any key on the front panel. The back light will turn off when the Terminal Equipment Controller is left unattended for 45 seconds.

## Local Keypad Interface

	The <b>YES</b> key is used to confirm a selection, to move onto the next menu item and to manually scroll through the displayed information.
	The <b>NO</b> key is used when you do not desire a parameter change, and to advance to the next menu item. May also be used to toggle between heating and cooling setpoints.
	The <b>MENU</b> key is used to access the Main User Menu or to exit the menu.
	The <b>DOWN ARROW</b> key is used to decrease a temperature setpoint and to adjust the desired values when configuring the Terminal Equipment Controller.
	The <b>UP ARROW</b> key is used to increase a temperature setpoint and to adjust the desired values when configuring the Terminal Equipment Controller.

## Sequence of User Menu

OVERRIDE RESUME	SYSTEM MODE SETTING	SCHEDULE SETTING	CLOCK SETTING
Override schd? Y/N (Appears only in unoccupied mode)	Sys mode set? Y/N	Schedule set? Y/N	Clock set? Y/N
Cancel ovrd? Y/N (Appears only in override mode)			



### A) Override an unoccupied period

**Override  
sched? Y/N**

This menu will appear only when the Terminal Equipment Controller is in unoccupied mode. The unoccupied mode is enabled either by the internal timer scheduling or by a remote NSB contact via DI1 or DI2.

If DI1 or DI2 is configured to operate as a remote temporary override contact, this menu will be disabled.

Answering yes to this prompt will cause the Terminal Equipment Controller to go into occupied mode for an amount of time equal to the parameter "TOccTime" (1 to 12 hours).

### B) Resume regular scheduling

**Cancel  
ovrd? Y/N**

This menu does not appear in regular operation. It will appear only when the Terminal Equipment Controller is in Unoccupied override mode. Answering "Yes" to this question will cause the Terminal Equipment Controller to resume the regular setpoints and scheduling.

### C) Temperature setpoints

#### Permanent setpoint changes

**Temperat  
set? Y/N**

This menu permits the adjustment of all permanent temperature setpoints (occupied and unoccupied) as well as the desired temperature units (°F or °C). Permanent setpoints are written to RAM and EEPROM.

COOLING SETPOINT OCCUPIED MODE		HEATING SETPOINT OCCUPIED MODE		COOLING SETPOINT UNOCCUPIED MODE	
Cooling set? Y/N	No next → Yes down ↓	Heating set? Y/N	No next → Yes down ↓	Unocc CL set? Y/N	No next → Yes down ↓
Use ▲▼ keys to set value, press Yes key to confirm					
Cooling 70.0 °F (21°C)	Use ▲▼ To set value	Heating 68.00 °F (20°C)	Use ▲▼ To set value	Unocc CL 80.0 °F (26.6°C)	Use ▲▼ To set value

HEATING SETPOINT UNOCCUPIED MODE		°F OR °C DISPLAY SETTING	
Unocc HT set? Y/N	No next → Yes down ↓	°F or °C set? Y/N	No next → Yes down ↓
Use ▲▼ keys to set value, press Yes key to confirm			
Unocc HT 60.0 °F (15.5°C)	Use ▲▼ To set value	Units °F (°C)	Use ▲▼ To set value

### Temporary setpoint changes

Temporary setpoints can be modified through the Up Arrow key (▲) and the Down Arrow key (▼). The user will be prompted with the present mode (Heating or Cooling) of the Terminal Equipment Controller and its setpoint. The Up (▲) arrow key will increment the setpoint by 0.5 degree (F or C). The Down (▼) arrow key will decrement the setpoint by 0.5 degree (F or C). Press the YES key to accept the new setpoint.

Local changes to the heating or cooling setpoints made by the user directly with the up/down arrow keys are temporary. They will remain effective for the duration specified by ToccTime. Setpoints will revert back to their default value after internal timer ToccTime expires. If a permanent change to the setpoints is required, use the **Temperat set? Y/N** menu.

### D) System mode setting

**Sys mode  
set ? Y/N**

This menu is accessed to set system mode operation. Use the arrow ▲▼ keys to set the value, the YES key to confirm the change.

<b>Sys mode auto</b>	<b>Automatic mode</b> Automatic changeover mode between heating and cooling operation
<b>Sys mode cooling</b>	<b>Cooling mode</b> Cooling operation mode only.
<b>Sys mode heating</b>	<b>Heating mode</b> Heating operation mode only.
<b>Sys mode emergency</b>	<b>Emergency heat mode</b> (Heat pump models only.) Forced auxiliary heat operation mode only.
<b>Sys mode off</b>	<b>Off mode</b> Normal cooling or heating operation disabled. If enabled in installer parameters, only the automatic heating frost protection at 50 °F ( 10 °C ) is enabled.

### E) Fan mode setting

**Fan mode set? Y/N**

This section of the menu permits the setting of the fan mode operation. Use the arrow ▲▼ keys to set the value, the YES key to confirm the change.

<b>Fan mode On</b>	<b>On fan mode</b> Fan is on continuously, even when system mode is OFF.
<b>Fan mode Auto</b>	<b>Automatic fan mode</b> Fan cycles on a call for heating or cooling for both occupied & unoccupied periods.
<b>Fan mode Smart</b>	<b>Smart fan mode</b> During occupied periods, fan is on continuously. In unoccupied mode, fan cycles on a call for heating or cooling. This selection is available on all models with a communication module, on all stand-alone (Network Ready) scheduling models or if DI1 or DI2 is set to RemNSB on stand-alone non-scheduling models.

### F) Schedule set (2 events)

Scheduling can have 2 or 4 events per day. This is set in the configuration menu as per parameter (2/4event).

**Schedule set? Y/N**

This section of the menu permits the user to select 2 or 4 events as needed. Each day can be tailored to specific schedules.

- 2 events can be scheduled per day.
- Occupied and unoccupied periods can be set for each day.

MONDAY TIMER SCHEDULE SET		TUESDAY TIMER SCHEDULE SET		WEDNESDAY TIMER SCHEDULE SET		OTHER DAYS ARE IDENTICAL
Monday set? Y/N	NO next → YES down ↓	Tuesday set? Y/N	NO next → YES down ↓	Wednesday set? Y/N	NO next → YES down ↓	Selects the day to be scheduled or modified
Use YES key to access day scheduling, NO key to jump to next day.						
Occupied day? Y/N	NO next → YES down ↓	Occupied day? Y/N	NO next → YES down ↓	Occupied day? Y/N	NO next → YES down ↓	YES = Daily schedules will be accessed NO = Unoccupied mode all day
Use YES key to access day scheduling, NO key to jump to next day.						
		Copy previous? Y/N	NO next → YES down ↓	Copy previous? Y/N	NO next → YES down ↓	YES = Will copy previous day schedule NO = Daily schedules will be accessed
Use YES key to copy previous day, NO key to set new time value for each day.						
Occupied 00:00 AM	Use ▲▼ To set value	Occupied 00:00 AM	Use ▲▼ To set value	Occupied 00:00 AM	Use ▲▼ To set value	Sets Event # 1 Occupied time will activate Occupied setpoints
Use ▲▼ to set value, YES key to confirm						
Unoccup 00:00 AM	Use ▲▼ To set value	Unoccup 00:00 AM	Use ▲▼ To set value	Unoccup 00:00 AM	Use ▲▼ To set value	Sets Event # 2 Unoccupied time will activate Unoccupied setpoints
Use ▲▼ to set value, YES key to confirm						

### Example 1: Office building closed all weekend

Setpoint	Period 1 Event 1		Period 1 Event 2		Daily Occupancy
	Cool	Heat	Cool	Heat	
	72 °F (22.2°C)	70 °F (21°C)	80 °F (26.6°C)	62 °F (16.6°C)	
Monday	7.00 AM		6.00 PM		Daytime only
Tuesday	7.00 AM		6.00 PM		Daytime only
Wednesday	7.00 AM		6.00 PM		Daytime only
Thursday	7.00 AM		6.00 PM		Daytime only
Friday	7.00 AM		6.00 PM		Daytime only
Saturday	12.00 PM *		12.00 PM *		Unoccupied
Sunday	12.00 PM *		12.00 PM *		Unoccupied

Notes

\*Scheduling consecutive events to the same time will cause the Terminal Equipment Controller to choose the last event as the time at which it will set its schedule. In the above example, the Terminal Equipment Controller will control to the unoccupied set point until 7:00 AM Monday.

### Example 2: Commercial building occupied all weekend

Setpoint	Period 1 Event 1		Period 1 Event 2		Daily Occupancy
	Cool	Heat	Cool	Heat	
	72 °F (22.2°C)	70 °F (21°C)	80 °F (26.6°C)	62 °F (16.6°C)	
Monday	8.00 AM		5.00 PM		Daytime only
Tuesday	8.00 AM		5.00 PM		Daytime only
Wednesday	8.00 AM		5.00 PM		Daytime only
Thursday	8.00 AM		5.00 PM		Daytime only
Friday	8.00 AM		5.00 PM		Daytime only
Saturday	12.00 AM **		11.59 PM **		Occupied
Sunday	12.00 AM **		11.59 PM **		Occupied

Notes

12:00 PM = Noon and 12:00 AM = Midnight

\*\*To schedule a day as occupied for 24 hours, set that day occupied time to 12:00 AM and Unoccupied time to 11:59 PM There will be a 1 minute unoccupied period every night at 11:59 PM with this schedule configuration.

G) Schedule set (4 events)

**Schedule set? Y/N**

This section of the menu permits the user to select 2 or 4 events as needed. Each day can be tailored to specific schedules.

- 4 events can be scheduled per day.
- Occupied and Unoccupied periods can be set for each day.
- Scheduling the 3rd & 4th events to the same time will cancel the last period.

MONDAY TIMER SCHEDULE SET		TUESDAY TIMER SCHEDULE SET		WEDNESDAY TIMER SCHEDULE SET		OTHER DAYS ARE IDENTICAL	
Monday set? Y/N	NO next → YES down ↓	Tuesday set? Y/N	NO next → YES down ↓	Wednesday set? Y/N	NO next → YES down ↓	Selects the day to be scheduled or modified	
Use YES key to access day scheduling, NO key to jump to next day.							
Occupied day? Y/N	NO next → YES down ↓	Occupied day? Y/N	NO next → YES down ↓	Occupied day? Y/N	NO next → YES down ↓	YES = Daily schedules will be accessed NO = Unoccupied mode all day	
Use YES key to access day scheduling, NO key to jump to next day.							
		Copy previous? Y/N	NO next → YES down ↓	Copy previous? Y/N	NO next → YES down ↓	YES = Will copy previous day schedule NO = Daily schedules will be accessed	
Use YES key to copy previous day, NO key to set new time value for each day.							
Occupied 00:00 AM	Use ▲▼ To set value	Occupied 00:00 AM	Use ▲▼ To set value	Occupied 00:00 AM	Use ▲▼ To set value	Sets Event # 1 Occupied time will activate Occupied setpoints	
Use ▲▼ to set value, YES key to confirm							
Unoccup 00:00 AM	Use ▲▼ To set value	Unoccup 00:00 AM	Use ▲▼ To set value	Unoccup 00:00 AM	Use ▲▼ To set value	Sets Event # 2 Unoccupied time will activate Unoccupied setpoints	
Use ▲▼ to set value, YES key to confirm							
Occupie2 00:00 AM	Use ▲▼ To set value	Occupie2 00:00 AM	Use ▲▼ To set value	Occupie2 00:00 AM	Use ▲▼ To set value	Sets Event # 3 Occupied time will activate Occupied setpoints	
Use ▲▼ to set value, YES key to confirm							
Unoccup2 00:00 AM	Use ▲▼ To set value	Unoccup2 00:00 AM	Use ▲▼ To set value	Unoccup2 00:00 AM	Use ▲▼ To set value	Sets Event # 4 Unoccupied time will activate Unoccupied setpoints	
Use ▲▼ to set value, YES key to confirm							

Example 1: Four event retail establishment schedule

Setpoint	Period 1 Event 1		Period 1 Event 2		Period 2 Event 3		Period 2 Event 4		Daily Occupancy
	Occupied		Unoccupied		Occupied		Unoccupied		
	Cool	Heat	Cool	Heat	Cool	Heat	Cool	Heat	
	72 °F (22.2°C)	70 °F (21°C)	80 °F (26.6°C)	62 °F (16.6°C)	72 °F (22.2°C)	70 °F (21°C)	80 °F (26.6°C)	62 °F (16.6°C)	
Monday	7.00 AM		5.00 PM		12.00 PM *		12.00 PM *		Daytime only
Tuesday	7.00 AM		5.00 PM		12.00 PM *		12.00 PM *		Daytime only
Wednesday	7.00 AM		5.00 PM		12.00 PM *		12.00 PM *		Daytime only
Thursday	7.00 AM		5.00 PM		7.00 PM		10.30 PM		Day/Eve only
Friday	7.00 AM		5.00 PM		7.00 PM		10.30 PM		Day/Eve only
Saturday	12.00 PM *		12.00 PM *		12.00 PM *		12.00 PM *		Unoccupied
Sunday	12.00 PM *		12.00 PM *		12.00 PM *		12.00 PM *		Unoccupied

Notes

\* Scheduling events to the same time will cancel the last period and leave the Terminal Equipment Controller in unoccupied mode

**Example 2: Four event residential schedule**

Setpoint	Period 1 Event 1		Period 1 Event 2		Period 2 Event 3		Period 2 Event 4		Daily Occupancy
	Occupied		Unoccupied		Occupied		Unoccupied		
	Cool	Heat	Cool	Heat	Cool	Heat	Cool	Heat	
	72 °F (22.2°C)	70 °F (21°C)	80 °F (26.6°C)	62 °F (16.6°C)	72 °F (22.2°C)	70 °F (21°C)	80 °F (26.6°C)	62 °F (16.6°C)	
<b>Monday</b>	6.00 AM		8.00 AM		4.00 PM		10.00 PM		Day/Eve only
<b>Tuesday</b>	6.00 AM		8.00 AM		4.00 PM		10.00 PM		Day/Eve only
<b>Wednesday</b>	6.00 AM		8.00 AM		4.00 PM		10.00 PM		Day/Eve only
<b>Thursday</b>	6.00 AM		8.00 AM		4.00 PM		10.00 PM		Day/Eve only
<b>Friday</b>	6.00 AM		8.00 AM		4.00 PM		11.30 PM		Day/Eve only
<b>Saturday</b>	8.00 AM *		8.00 AM *		8.00 AM *		11.59 PM *		Daytime only
<b>Sunday</b>	12.00 AM *		12.00 AM *		12.00 AM *		11.59 PM *		All day

**Notes**

\*Scheduling consecutive events to the same time will cause the Terminal Equipment Controller to choose the last event as the time at which it will set its schedule. In the above example for Saturday, the Terminal Equipment Controller will control to the occupied set point from 8:00 AM until 11:59 PM. Since it is desired to be in occupied mode throughout the night, then it is necessary to schedule the first event on Sunday at 12:00 AM. The Terminal Equipment Controller will force a one minute unoccupied period for a one minute period (between 11:59 PM and 12:00 AM on Saturday).

**H) Clock / Day Settings**

**Clock set? Y/N**

This section of the menu permits the user to set the time and day.

TIME SETTING	DAY SETTING	TIME FORMAT SETTING
Time set? Y/N 0:00	NO next → YES down ↓ Day set? Y/N	NO next → YES down ↓ 12/24hrs set? Y/N
Time 00:00	Use ▲▼ To set value Day Monday	12/24hrs 12 hrs Use ▲▼ To set value

**J) Schedule Hold**

**Schedule hold? Y/N**

- This menu appears only on stand-alone (Network Ready) Terminal Equipment Controller, i.e., without a BACnet® Echelon® module.
- This section of the menu permits the user to set a permanent schedule hold, which bypasses the internal Terminal Equipment Controller scheduling.
- The permanent schedule hold function is typically used for non-scheduled events that extend for various periods of time.
- Enabling a permanent occupied or permanent unoccupied schedule hold will cancel any active override.
- The use of temporary setpoints during permanent hold is permitted. The duration of the temporary setpoint is as set per the TOccTime parameter. Ex. 3 hours.
- Use the arrow ▲▼ keys to set the value, the YES key to confirm the change.

**Schedule Hold and Resume Functions**

<b>Schedule occ hold</b>	<p><b>Hold permanent occupied</b> Forces the Terminal Equipment Controller into a permanent occupied mode using the occupied setpoints. All timed scheduling functions are by-passed.</p> <p>The PERMANENT OCCUPIED status will appear in the automatic status scroll. To resume to regular scheduling, scroll to the Schedule Hold menu and select the Schedule resume option.</p>
<b>Schedule uno hold</b>	<p><b>Hold permanent unoccupied</b> Forces the Terminal Equipment Controller into a permanent unoccupied mode using the unoccupied setpoints. All timed scheduling functions are by-passed.</p> <p>The PERMANENT UNOCCUPIED status will appear in the automatic status scroll. To resume to regular scheduling, scroll to the Schedule Hold menu and select the Schedule resume option.</p>
<b>Schedule resume</b>	<p><b>Resume regular scheduling</b> Cancels the permanent hold and re-enables the regular scheduling as set per internal schedule or as per remote NSB, via one of the DI's configured as remote NSB.</p> <p>This action can also be accomplished by using the Resume menu.</p> <p>Any temporary setpoints that are active will be left active for the duration of the period, as set per the TOccTime parameter.</p>

## INSTALLER CONFIGURATION PARAMETER MENU

Configuration can be performed through the network or locally at the Terminal Equipment Controller.

### Enter configuration

Press and hold the middle key (MENU) for eight seconds.

### Password

If a password lockout is active, "Password" is prompted. Enter a password value using the up/down arrow keys and then press the middle key again to gain access to all configuration properties of the Terminal Equipment Controller. Entering an incorrect password will prevent local access to the configuration menu.

### Scroll parameters

Press the NO key repetitively to scroll between all the available parameters.





### Adjust parameter

When the desired parameter is displayed, press the YES key to select it, then use the up/down arrow keys to adjust it to the desired value.

### Save new value

To acknowledge and save the new value, press YES key again. The next parameter will be displayed.

## Configuration interface

	The <b>YES</b> key is used to confirm a selection, to move onto the next menu item and to manually scroll through the displayed information.
	The <b>NO</b> key is used when you do not desire a parameter change, and to advance to the next menu item. May also be used to toggle between heating and cooling setpoints.
	The <b>MENU</b> key is used to access the Main User Menu or to exit the menu.
	The <b>DOWN ARROW</b> key is used to decrease a temperature setpoint and to adjust the desired values when configuring the Terminal Equipment Controller.
	The <b>UP ARROW</b> key is used to increase a temperature setpoint and to adjust the desired values when configuring the Terminal Equipment Controller.

**CONFIGURATION PARAMETERS**

Default Value	Significant Adjustments
<p><b>PswrdSet</b> Configuration parameters menu access password Default: 0 No password prompted</p>	<p>This parameter sets a password access to prevent unauthorized access to the configuration menu parameters. A default value of "0" will not prompt a password or lock the access to the configuration menu.</p> <p>Range is: 0 to 1000</p>
<p><b>Com Addr</b> Terminal Equipment Controller networking address Default: 254 Range is: 0 to 254</p>	<p><b>Conditional parameter to BACnet® MS-TP models SE76xxX5x45B</b></p> <p><b>Conditional parameter to Wireless models SE76xxX5x45W</b></p> <p>This parameter will only appear when a BACnet® or wireless network adapter is present. If the Terminal Equipment Controller is installed as a stand-alone (Network Ready) unit or with an Echelon® adapter, this parameter will not be used or displayed</p> <p>For BACnet® MS-TP models, the valid range is from 1 to 127. Default value of 254 disables BACnet® communication for the Terminal Equipment Controller. For wireless models, the valid range is 0 to 254 with a maximum of 30 Terminal Equipment Controllers per VWG</p>
<p><b>PAN ID</b> Personal Area Network Identification Default: 0 Range is: 0 to 1045</p>	<p><b>Conditional parameter to Wireless models SE76xxX5x45W</b></p> <p>This parameter will only appear when a wireless network adapter is present. If the Terminal Equipment Controller is installed as a stand-alone (Network Ready) unit or with a BACnet® or Echelon® adapter, this parameter will not be used or displayed.</p> <p>This parameter (Personal Area Network Identification) is used to link specific Terminal Equipment Controllers to a single specific Schneider Electric wireless gateway (VWG) . For every Terminal Equipment Controller reporting to a gateway (maximum of 30 Terminal Equipment Controllers per gateway), be sure you set the SAME PAN ID value both on the gateway and the Terminal Equipment Controller(s).</p> <p>The default value of 0 is NOT a valid PAN ID.</p>
<p><b>Channel</b> Channel selection Default: 10 Range is: 10 to 26</p>	<p><b>Conditional parameter to Wireless models SE76xxX5x45W</b></p> <p>This parameter will only appear when a wireless network adapter is present. If the Terminal Equipment Controller is installed as a stand-alone (Network Ready) unit or with a BACnet® or Echelon® adapter, this parameter will not be used or displayed.</p> <p>This parameter (Channel) is used to link specific Terminal Equipment Terminal Equipment Controllers to specific Schneider Electric wireless gateway(s) (VWG). For every Terminal Equipment Terminal Equipment Controller reporting to a gateway (maximum of 30 Terminal Equipment Controllers per gateway), be sure you set the SAME channel value both on the gateway and the Terminal Equipment Controller(s).</p> <p><b>Schneider Electric recommends using only channels 15 and 25.</b></p> <p>The default value of 10 is NOT a valid channel. The valid range of available channels is from 11 to 26</p>

**CONFIGURATION PARAMETERS**

Default Value	Significant Adjustments
<p><b>DI 1</b>                      Digital input no.1 configuration                      Open contact input = function not energized                      Closed contact input = function energized                      Default Value = None</p>	<p><b>(None)</b> : No function will be associated with the input</p> <p><b>(Rem NSB)</b>: remote NSB timer clock input. Will disable the internal scheduling of the Terminal Equipment Controller. The scheduling will now be set as per the digital input. The time is still displayed as information, but the menu part related to scheduling is disabled and no longer accessible.</p> <ul style="list-style-type: none"> <li>• Open contact = occupied setpoints</li> <li>• Closed contacts = unoccupied setpoints</li> </ul> <p><b>(RemOVR)</b>: Temporary override remote contact. Disables all override menu function of the Terminal Equipment Controller. The override function is now controlled by a manual remote momentarily closed contact. When configured in this mode, the input operates in a toggle mode. With this function enabled it is now possible to toggle between unoccupied &amp; occupied setpoints for the amount of time set by parameter (TOccTime) temporary occupancy time. When Override is enabled, an Override status message will be displayed</p> <p><b>(Filter)</b>: a back-lit flashing Filter alarm will be displayed on the Terminal Equipment Controller LCD screen when the input is energized</p> <p><b>(Service)</b>: a back-lit flashing Service alarm will be displayed on the Terminal Equipment Controller LCD screen when the input is energized</p> <p><b>(Fan lock)</b>: a back-lit flashing Fan lock alarm will be displayed on the Terminal Equipment Controller LCD screen when the input is not energized. Used in conjunction with a local airflow sensor connected to the input. Locks out the Terminal Equipment Controller heating and cooling action if no airflow is detected 10 seconds after the fan ( G terminal ) is energized.</p> <ul style="list-style-type: none"> <li>• Open contact = no airflow</li> <li>• Closed contacts = airflow present</li> </ul>
<p><b>DI 2</b>                      Digital input no. 2 configuration                      Default Value = None</p>	<p>Same as above. It is possible to configure both inputs to have the same function.</p>
<p><b>MenuScro</b>                      Menu scroll                      Default: On - Scroll active</p>	<p>Removes the scrolling display and displays the room temperature/humidity to the user. With this option enabled, no mode, schedule and outdoor temperature status is given.</p> <ul style="list-style-type: none"> <li>• On = Scroll active</li> <li>• Off = Scroll not active</li> </ul>

**CONFIGURATION PARAMETERS**

Default Value		Significant Adjustments																														
<b>lockout</b> Keypad lockout levels Default value = 0 (No lock)		0 = No lock 1 = Low level 2 = High level																														
<b>USER KEY FUNCTIONS</b>																																
LEVEL	Resume/ Override Scheduling	Permanent Occupied and Unoccupied Setpoints	Temporary setpoints using arrows	System mode setting	Fan mode setting	Schedules setting	Clock setting	Permanent hold																								
0	Unlocked	Unlocked	Unlocked	Unlocked	Unlocked	Unlocked	Unlocked	Unlocked																								
1	Unlocked	Locked	Unlocked	Locked	Locked	Locked	Unlocked	Locked																								
2	Locked	Locked	Locked	Locked	Locked	Locked	Unlocked	Locked																								
<b>pwr del</b> Power-up delay Default value = 10 seconds		On initial power up of the Terminal Equipment Controller (each time 24 Vac power supply is removed & re-applied) there is a delay before any operation is authorized (fan, cooling or heating). This can be used to sequence start up multiple units / Terminal Equipment Controller in one location. 10 to 120 seconds																														
<b>Frost pr</b> Frost protection enabled Default value = Off		Off: no room frost protection On: room frost protection enabled in all system mode at: 42 °F ( 5.6 °C ) Frost protection is enabled even in system Off mode Off or On (On heat pump models the system mode will be forced to EMERGENCY mode if frost protection is activated.)																														
<b>Heat max</b> Maximum heating set point limit Default: 90 °F ( 32 °C )		Maximum occupied & unoccupied heating set point adjustment. Heating set point range is: 40 to 90 °F (4.5 to 32.0 °C)																														
<b>Cool min</b> Minimum cooling set point limit Default: 54 °F ( 12 °C )		Minimum occupied & unoccupied cooling set point adjustment. Cooling set point range is: 54 to 100 °F (12.0 to 37.5 °C)																														
<b>Pband</b> Proportional Band setting Default value 2 = 2.0 °F ( 0.6 °C )		Adjusts the proportional band used by the Terminal Equipment Controller PI control loop.   Note that the default value of 2.0 °F (1.1 °C) gives satisfactory operation in most normal installation cases. The use of a proportional band different than the factory one is normally warranted in applications where the Terminal Equipment Controller location is problematic and leads to unwanted cycling of the unit. A typical example is a wall mounted unit where the Terminal Equipment Controller is installed between the return and supply air feeds and is directly influenced by the supply air stream of the unit.																														
		<table border="1" style="margin-left: auto; margin-right: auto;"> <thead> <tr> <th>VALUE</th> <th>°F SCALE PBAND</th> <th>°C SCALE PBAND</th> </tr> </thead> <tbody> <tr> <td>2</td> <td>2 F</td> <td>1.1 C</td> </tr> <tr> <td>3</td> <td>3 F</td> <td>1.7 C</td> </tr> <tr> <td>4</td> <td>4 F</td> <td>2.2 C</td> </tr> <tr> <td>5</td> <td>5 F</td> <td>2.8 C</td> </tr> <tr> <td>6</td> <td>6 F</td> <td>3.3 C</td> </tr> <tr> <td>7</td> <td>7 F</td> <td>3.9 C</td> </tr> <tr> <td>8</td> <td>8 F</td> <td>4.4 C</td> </tr> </tbody> </table>							VALUE	°F SCALE PBAND	°C SCALE PBAND	2	2 F	1.1 C	3	3 F	1.7 C	4	4 F	2.2 C	5	5 F	2.8 C	6	6 F	3.3 C	7	7 F	3.9 C	8	8 F	4.4 C
VALUE	°F SCALE PBAND	°C SCALE PBAND																														
2	2 F	1.1 C																														
3	3 F	1.7 C																														
4	4 F	2.2 C																														
5	5 F	2.8 C																														
6	6 F	3.3 C																														
7	7 F	3.9 C																														
8	8 F	4.4 C																														



**CONFIGURATION PARAMETERS**

Default Value	Significant Adjustments
<p><b>Anticycle</b> Minimum On-Off operation time for stages Default value = 2 minutes</p>	<p>Minimum On-Off operation time of cooling &amp; heating stages.</p> <p>IMPORTANT, anti-short cycling can be set to 0 minutes for equipment that posses their own anti cycling timer. Do not use this value unless the equipment is equipped with such internal timer. Failure to do so can damage the equipment. 0, 1, 2, 3, 4 &amp; 5 minutes</p> <p>Anti-short cycling can be set to 0 minutes for equipment that posses their own anti cycling timer. Do not use that value unless the equipment is equipped with such internal timer. Failure to do so can damage the equipment.</p>
<p><b>cool cph</b> Cooling stages cycles per hour Default value = 4 C.P.H.</p>	<p>Will set the maximum number of cooling stage cycles per hour under normal control operation. It represents the maximum number of cycles that the equipment will turned on and off in one hour. Note that a higher C.P.H will represent a higher accuracy of control at the expense of wearing mechanical components faster. 3 or 4 C.P.H.</p> <p>For multistage models, cool cph applies to Y1 &amp; Y2</p> <p>For heat pump models, cool cph applies to Y1 &amp; Y2 in cooling and heating independently of the reversing valve position.</p>
<p><b>Deadband</b> Minimum deadband Default: 2.0 °F (1.1 °C)</p>	<p>The minimum deadband value between the heating and cooling set points. When modified, it will take effect only when any of the set points are modified.</p> <p>Range is: 2, 3, or 4 °F, 1.0 °F increments (1.0 to 2.0 °C)</p>
<p><b>fan cont</b> Fan control Default value = On</p>	<p>Fan control in heating mode. When selecting On; the Terminal Equipment Controller in all cases will always control the fan (terminal G). Valid for On or Auto fan mode When selecting Off; the fan (terminal G), when heating stages (terminals W1 &amp; W2) are solicited, will not be energized. The fan in this case will be controlled by the equipment fan limit control. Valid only for Auto fan mode. On fan mode will leave the fan always on.</p> <p>ON OR OFF</p> <p>For multistage models, fan control applies to W1 &amp; W2 For heat pump models, fan control applies to W1 only (Emergency heat).</p>

**CONFIGURATION PARAMETERS**

Default Value	Significant Adjustments
<b>fan del</b> Fan delay Default value = Off	Fan delay extends fan operation by 60 seconds after the call for heating or cooling ends. Valid only for Auto fan mode. "On" fan mode will leave the fan always on. Off or On
<b>TOccTime</b> Temporary occupancy time Default: 3 hours	Temporary occupancy time with occupied mode setpoints when override function is enabled.  When the Terminal Equipment Controller is in unoccupied mode, function is enabled with either the menu or DI1 or DI2 configured as remote override input.  0,1, 2, 3, 4, 5, 6, 7, 8, 9, 10, 11 & 12 hours
<b>Cal RS</b> Room air temperature sensor calibration Default: 0.0 °F or °C	Offset that can be added/subtracted to the actual displayed room temperature.  Range is: ± 5.0 °F (± 2.5 °C)
<b>Cal OS</b> Outside air temperature sensor calibration Default value = 0.0 °F or °C	Offset that can be added/subtracted to actual displayed outside air temperature ± 5.0 °F (± 2.5 °C)
<b>C stage or HP stage</b> Number of cooling stages. 2 stages model only Default value = 2 stages	Will revert the operation of 2 stage Terminal Equipment Controller to single stage operation only when the second cooling step is not needed.  1 or 2 stages  For heat pump models, HP stage selects the number of compressor stages.
<b>H lock</b> Outside air temperature heating lockout Default value = 120 °F (49 °C)	Disables heating stage operation based on outdoor air temperature. Function will only be enabled if OS (outside air temperature sensor ) is connected.  From -15 °F up to 120 °F ( -26 °C up to 49 °C )
<b>C lock</b> Outside air temperature mechanical cooling lockout. Default value = -40 °F (-40 °C)	Disables cooling stage operation based on outdoor air temperature. On economizer model, free cooling will not be disabled by this function. Function will only be enabled if OS (outside air temperature sensor) is connected.  From -40 °F up to 95 °F ( -40 °C up to 35 °C )
<b>Unocc TM</b> Unoccupied Timer value Default = 0.5 hours	Time delay between the moment where the Terminal Equipment Controller toggles from occupied to unoccupied after the last movement has been detected by the PIR.  Range is: 0.5 to 24.0 hours in 0.5 hour increments.

**CONFIGURATION PARAMETERS**

Default Value	Significant Adjustments									
<p><b>2/4event</b> Number of events configuration Default value = 2 events</p>	<p>2 events, will set up scheduling for the following: Event 1 is for Occupied setpoints Event 2 is for Unoccupied setpoints</p> <p>4 events, will set up scheduling for the following: Event 1 is for Occupied setpoints Event 2 is for Unoccupied setpoints Event 3 is for Occupied setpoints Event 4 is for Unoccupied setpoints</p>									
<p><b>aux cont</b> Auxiliary contact function &amp; configuration Default value = N.O. normally open</p>	<p>This contact can be used to energize peripheral devices such as: lighting equipment, exhaust fans, economizers, etc. This contact will operate in parallel with the internal occupied/unoccupied schedule of the Terminal Equipment Controller or the remote NSB contact if DI1 or DI2 is used. When the system is in OFF mode, the contact will remain in its unoccupied status independently of the occupied / unoccupied schedule.</p> <table border="1" style="margin-left: auto; margin-right: auto;"> <thead> <tr> <th style="background-color: #008000; color: white;">Configured</th> <th style="background-color: #008000; color: white;">Contact occupied status</th> <th style="background-color: #008000; color: white;">Contact unoccupied status</th> </tr> </thead> <tbody> <tr> <td style="text-align: center;"><b>N.O.</b></td> <td style="text-align: center;">Closed</td> <td style="text-align: center;">Opened</td> </tr> <tr> <td style="text-align: center;"><b>N.C.</b></td> <td style="text-align: center;">opened</td> <td style="text-align: center;">Closed</td> </tr> </tbody> </table>	Configured	Contact occupied status	Contact unoccupied status	<b>N.O.</b>	Closed	Opened	<b>N.C.</b>	opened	Closed
Configured	Contact occupied status	Contact unoccupied status								
<b>N.O.</b>	Closed	Opened								
<b>N.C.</b>	opened	Closed								
<p><b>SH lock</b> Outside air temperature supply heat lockout Default value = 32 °F (0 °C)</p>	<p>Disables heating operation based on outdoor air temperature. Please refer to the Schneider-Electric Zoning System Guide for recommended settings. From -15 °F up to 120 °F (-26 °C up to 49 °C) (increments: 5° or 50°)</p>									
<p><b>Min SH</b> Minimum supply heat temperature setpoint Default value = 64 °F (18 °C)</p>	<p>Sets the minimum supply heat to be maintained by the controller during occupied periods (Occupied or Temporary Override). From 50 °F up to 72 °F (10 °C up to 22 °C) (increments: 0.5° or 5°)</p>									

### CONFIGURATION PARAMETERS

Default Value	Significant Adjustments
<b>Prog rec</b> Progressive recovery enabled Default value = Off Progressive recovery is automatically disabled if DI 1 and / or DI 2 are configured remote NSB	Off, = no progressive recovery The occupied schedule time is the time at which the system will restart.  On, = progressive recovery active. The occupied schedule time is the time at which the desired occupied temperature will be attained. The Terminal Equipment Controller will automatically optimize the equipment start time.  In any case, the latest a system will restart is 10 minutes prior to the occupied period time.
<b>Dis HL</b> Discharge air temperature high limit Default: 120°F	Discharge air high temperature value at which the heating output will be locked out. 70°F to 150°F (21°C to 65°C) (increments: 0.5° or 5°)
<b>Dis LL</b> Discharge air temperature low limit Default: 45°F	Discharge air low temperature value at which the cooling stages will be locked out. 35°F to 65°F (2.0°C to 19.0°C) (increments: 0.5° or 5°)
<b>MS dis</b> Display mixed air temperature	Used as diagnostic aid to troubleshoot and diagnose economizer operation.

### DISCHARGE AIR CONTROL

The Schneider-Electric SE7600F controller has the ability to maintain a minimum heating supply temperature by using an analog 0-10VDC proportional output instead of using the staging outputs which will cause the unit to cycle. Using a full proportional output to maintain the minimum heating supply temperature can increase cost savings and reduce wear and tear on HVAC equipment.

The desired minimum setpoint temperature value can be set under the Min SH parameter and the following conditions must apply:

- The system mode is Heating.
- The occupancy mode is Occupied or in Temporary Override.
- The OA temperature value is below the SH lockout parameter value.

**SPECIFICATIONS**

Terminal Equipment Controller power requirements:	19-30 VAC 50 or 60 Hz; 2 VA Class 2 RC to RH jumper 2.0 Amps 48VA max.
Operating conditions	0 °C to 50 °C ( 32 °F to 122 °F ) 0% to 95% R.H. non-condensing
Storage conditions	-30 °C to 50 °C ( -22 °F to 122 °F ) 0% to 95% R.H. non-condensing
Temperature sensor	Local 10 K NTC thermistor
Temperature sensor resolution	± 0.1 °C ( ± 0.2 °F )
Temperature control accuracy	± 0.5 °C ( ± 0.9 °F ) @ 21 °C ( 70 °F ) typical calibrated
Contact output rating	Relay output: 30 VAC, 1 Amp. Maximum, 3 Amp. In-rush.
Occ, Stand-By and Unocc cooling set point range	12.0 to 37.5 °C ( 54 to 100 °F )
Occ, Stand-By and Unocc heating set point range	4.5 °C to 32 °C ( 40 °F to 90 °F )
Room and outdoor air temperature display range	-40 °C to 50 °C ( -40 °F to 122 °F )
Digital inputs	Dry contact across terminal DI1, DI2
Wire gauge	18 gauge max. 22 gauge min.
Approximate shipping weight	0.75 lb ( 0.34 kg )
Agency Approvals all models	UL: UL 873 (US) and CSA C22.2 No. 24 (Canada), File E27734 with CCN XAPX (US) and XAPX7 (Canada) Industry Canada: ICES-003 (Canada)
Agency Approvals all models	FCC: Compliant to CFR 47, Part 15, Subpart B, Class A (US) CE : EMC Directive 2004/108/EC (Europe Union) C-Tick: AS/NZS CISPR 22 Compliant (Australia / New Zealand) Supplier Code Number N10696
Agency Approvals Wireless models	FCC: Compliant to: Part 15, Subpart B, Class (US)
THIS DEVICE COMPLIES WITH PART 15 OF THE FCC RULES. OPERATION IS SUBJECT TO THE FOLLOWING TWO CONDITIONS: (1) THIS DEVICE MAY NOT CAUSE HARMFUL INTERFERENCE, AND (2) THIS DEVICE MUST ACCEPT ANY INTERFERENCE RECEIVED, INCLUDING INTERFERENCE THAT MAY CAUSE UNDESIRE OPERATION.	
 Please check with your local government for instruction on disposal of this product.	

DIMENSIONAL DRAWING

