

# Operation Manual

## Modular Power Distribution Unit 480V with Auto-transformer

PDPM288G6H

990-3342C

Publication Date: September, 2015

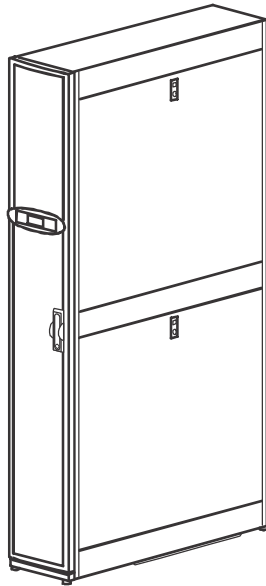

## Schneider Electric IT Corporation Legal Disclaimer

The information presented in this manual is not warranted by the Schneider Electric IT Corporation to be authoritative, error free, or complete. This publication is not meant to be a substitute for a detailed operational and site specific development plan. Therefore, Schneider Electric IT Corporation assumes no liability for damages, violations of codes, improper installation, system failures, or any other problems that could arise based on the use of this Publication.

The information contained in this Publication is provided as is and has been prepared solely for the purpose of evaluating data center design and construction. This Publication has been compiled in good faith by Schneider Electric IT Corporation. However, no representation is made or warranty given, either express or implied, as to the completeness or accuracy of the information this Publication contains.

**IN NO EVENT SHALL SCHNEIDER ELECTRIC IT CORPORATION, OR ANY PARENT, AFFILIATE OR SUBSIDIARY COMPANY OF SCHNEIDER ELECTRIC IT CORPORATION OR THEIR RESPECTIVE OFFICERS, DIRECTORS, OR EMPLOYEES BE LIABLE FOR ANY DIRECT, INDIRECT, CONSEQUENTIAL, PUNITIVE, SPECIAL, OR INCIDENTAL DAMAGES (INCLUDING, WITHOUT LIMITATION, DAMAGES FOR LOSS OF BUSINESS, CONTRACT, REVENUE, DATA, INFORMATION, OR BUSINESS INTERRUPTION) RESULTING FROM, ARISING OUT, OR IN CONNECTION WITH THE USE OF, OR INABILITY TO USE THIS PUBLICATION OR THE CONTENT, EVEN IF SCHNEIDER ELECTRIC IT CORPORATION HAS BEEN EXPRESSLY ADVISED OF THE POSSIBILITY OF SUCH DAMAGES. SCHNEIDER ELECTRIC IT CORPORATION RESERVES THE RIGHT TO MAKE CHANGES OR UPDATES WITH RESPECT TO OR IN THE CONTENT OF THE PUBLICATION OR THE FORMAT THEREOF AT ANY TIME WITHOUT NOTICE.**

Copyright, intellectual, and all other proprietary rights in the content (including but not limited to software, audio, video, text, and photographs) rests with Schneider Electric It Corporation or its licensors. All rights in the content not expressly granted herein are reserved. No rights of any kind are licensed or assigned or shall otherwise pass to persons accessing this information.

This Publication shall not be for resale in whole or in part.

# Contents

---

<b>Overview</b> .....	<b>1</b>
<b>Safety</b> .....	<b>2</b>
Regulatory agency approval .....	2
<b>Commissioning</b> .....	<b>3</b>
<b>Pre-Start Checklists</b> .....	<b>3</b>
Initial Inspection Checklist .....	3
Electrical Inspection Checklist .....	3
User Interface Inspection Checklist .....	3
Final Inspection Checklist .....	3
<b>Start-up Inspection Checklist</b> .....	<b>4</b>
<b>Operation</b> .....	<b>5</b>
<b>Display Interface</b> .....	<b>5</b>
Navigate the display interface .....	6
Top dynamic display .....	6
Main menu screen .....	7
Menu tree .....	7
Password protection .....	8
<b>Modules Submenu</b> .....	<b>9</b>
View Module status .....	9
View Power Distribution Module information .....	10
View circuit status information .....	11
View or reset module energy usage .....	12
Configure individual load name, location, and alarm thresholds .....	13
Enable/Disable alarm thresholds for individual loads .....	14
Enable/Disable module breaker-position alarms .....	14
Reset module alarm settings to default .....	15
Mass configuration of alarms .....	16
Reset module cable settings to their default values .....	17
<b>Subfeeds Submenu</b> .....	<b>18</b>
View general subfeed information .....	18
View subfeed operational status and configure name/location .....	19
Configure warning and critical alarm thresholds for subfeeds .....	20
Enable or disable alarm thresholds and alarms for subfeed breakers .....	21
Reset subfeed energy usage .....	21
<b>Totals Submenu</b> .....	<b>22</b>
View total load status .....	22
Total output current by phase .....	22
View or reset total energy usage by phase .....	23
View total voltage and frequency .....	24
View distribution panel settings .....	24
Configure critical and warning alarm thresholds for total output current .....	25
Configure critical and warning alarm thresholds for total output voltage .....	26
Configure the nominal frequency range to affect alarm conditions .....	27
<b>Environment Submenu</b> .....	<b>27</b>
View the status or configure input contact settings .....	27
Configure output relay settings .....	28
Configure the alarm relay map .....	29

<b>Alarms Submenu</b> .....	<b>30</b>
View alarms .....	30
<b>Log Submenu</b> .....	<b>31</b>
<b>Admin Submenu</b> .....	<b>32</b>
Configure the network address settings .....	32
Upgrade metering board firmware .....	33
Change the password .....	33
Change display interface settings .....	34
Change the date and time on the display interface .....	35
Configure device ID settings .....	35
View system component information .....	36
Set the configuration to factory defaults .....	36
<b>Help Submenu</b> .....	<b>36</b>
Use the Help feature .....	36
<b>Modbus Configuration</b> .....	<b>37</b>
Configure Modbus through the Display Interface .....	37
Modbus configuration .....	37
Modbus cable connection .....	38
<b>Network Management Configuration</b> .....	<b>39</b>
<b>Overview</b> .....	<b>39</b>
Initial setup .....	39
Device IP Configuration Wizard .....	39
Supported Web browsers .....	40
Network management features .....	40
<b>Log On</b> .....	<b>41</b>
URL address formats .....	41
<b>Security</b> .....	<b>42</b>
Access priority for logging on .....	42
User accounts .....	42
<b>Watchdog Features</b> .....	<b>42</b>
Network interface watchdog mechanism .....	42
Resetting the network timer .....	42
<b>Recover from a Lost Password</b> .....	<b>43</b>
<b>Maintenance</b> .....	<b>44</b>
<b>Parts Replacement</b> .....	<b>44</b>
Determine if you need a replacement part .....	44
Return parts .....	44
<b>Power Distribution Modules</b> .....	<b>45</b>
Component identification .....	45
Module circuit breaker operation .....	46
Installation .....	47
Remove a PDM .....	52
<b>Troubleshooting</b> .....	<b>53</b>
<b>LEDs on Power Distribution Modules</b> .....	<b>53</b>
<b>Status and Alarm Messages</b> .....	<b>53</b>

# Overview

---

Read the instructions carefully to become familiar with the device before trying to install, operate, service or maintain it.

**About This Manual.** This manual contains important safety warnings and instructions, gives an introduction to the display interface and provides detailed information for proper use of the equipment.

**Related Documents.** Download technical publications or look for updates to your manual at [www.schneider-electric.com](http://www.schneider-electric.com).

**User Comments.** Contact [www.schneider-electric.com](http://www.schneider-electric.com). We welcome your comments about this document.

# Safety

---

This manual contains important instructions that must be followed during installation, operation, and maintenance of the PDU. For safety reasons, only trained users are allowed to operate the display interface and replace the Power Distribution Modules (PDMs).

<b>⚠ ⚠ DANGER</b>
<b>HAZARD OF ELECTRIC SHOCK, EXPLOSION, OR ARC FLASH</b>
<ul style="list-style-type: none"><li>• Electrical equipment must be installed, operated, serviced, and maintained only by qualified personnel.</li><li>• To remove a Power Distribution Module:<ul style="list-style-type: none"><li>- Turn off all power supplying the equipment and perform appropriate lockout/tagout procedures before installing or removing the Power Distribution Module.</li><li>OR</li><li>- If a Symmetra PX UPS is providing power to the Modular PDU, place the UPS into battery operation (to reduce fault current) before removing the Power Distribution Module.</li></ul></li><li>• The PDU must be installed in accordance with the National Electrical Code or the Canadian Electrical Code and all applicable local codes.</li><li>• Service access areas are locked with a Red Key. The Red Keys must remain under the control of qualified service personnel.</li><li>• Wear appropriate personal protection equipment (PPE) when performing maintenance on this PDU.</li></ul>
<b>Failure to follow these instructions will result in death or serious injury.</b>

<b>⚠ WARNING</b>
<b>UNEXPECTED BEHAVIOR OF APPLICATION</b>
Only trained users should operate the display or replace the Power Distribution Modules.
<b>Failure to follow these instructions can result in death, serious injury, or equipment damage.</b>

<b>⚠ CAUTION</b>
<b>UNPROTECTED OUTPUTS</b>
Apply circuit protection to all outputs.
<b>Failure to follow these instructions can result in equipment damage.</b>

## Regulatory agency approval

This equipment has been tested and found to comply with the limits for a class A digital device, pursuant to part 15 of the FCC Rules. These limits are designed to provide reasonable protection against harmful interference when the equipment is operated in a commercial environment. This equipment generates, uses, and can radiate radio frequency energy and, if not installed and used in accordance with the installation guide, may cause harmful interference to radio communications. Operation of this equipment in a residential area is likely to cause harmful interference, in which case the user will be required to correct the interference at his own expense.

This class A digital apparatus complies with Canadian ICES-003.

Cet appareil numérique de la classe A est conforme à la norme NMB-003 du Canada.

This is a class A product. In a domestic environment this product may cause interference, in which case the user may be required to take adequate measures.

# Commissioning

## Pre-Start Checklists

<b>⚠ ⚠ DANGER</b>
<b>HAZARD OF ELECTRIC SHOCK, EXPLOSION, OR ARC FLASH</b>
<ul style="list-style-type: none"><li>• Procedures in this section should be performed by qualified personnel only.</li><li>• Equipment must be properly de-energized and locked-out prior to performing service.</li></ul>
<b>Failure to follow these instructions will result in death or serious injury.</b>

After installation, verify that all components are working properly and that the equipment is ready to begin operation.

### Initial Inspection Checklist

Ensure the:

<input type="checkbox"/>	Installation procedure is complete according to the installation manual.
<input type="checkbox"/>	Equipment shows no signs of damage.
<input type="checkbox"/>	Clearance around the equipment is in accordance with local and national codes and regulations as well as the installation manual.
<input type="checkbox"/>	Equipment is leveled and joined to the adjacent racks as specified in the installation manual.

### Electrical Inspection Checklist

Ensure the:

<input type="checkbox"/>	Incoming voltages match the phase and voltage listing on the nameplate.
<input type="checkbox"/>	Electrical wiring complies with local and national codes and regulations.
<input type="checkbox"/>	Equipment is properly grounded.
<input type="checkbox"/>	All field electrical connections are tight.
<input type="checkbox"/>	Circuit breakers are correct.

### User Interface Inspection Checklist

Ensure the:

<input type="checkbox"/>	Building management system is connected correctly..
<input type="checkbox"/>	Network port is connected correctly and an IP address has been assigned to the equipment.

### Final Inspection Checklist

Ensure the:

<input type="checkbox"/>	System is clean and free from debris.
<input type="checkbox"/>	Packaging materials are disposed of properly.

# Start-up Inspection Checklist

**⚡ ⚠ DANGER**

**HAZARD OF ELECTRIC SHOCK, EXPLOSION, OR ARC FLASH**

- Procedures in this section should be performed by qualified personnel only.
  - Wear appropriate personal protective equipment (PPE) when checking hazardous voltages.
- Failure to follow these instructions will result in death or serious injury.**

<input type="checkbox"/>	Verify that the PDU is in Total Power OFF mode. All circuit breakers and modules are OFF.
<input type="checkbox"/>	Set all modules that will be used to ON
<input type="checkbox"/>	1. Power Up the PDU. 2. Make sure the incoming power circuit breaker is set to ON. 3. If applicable, set the Subfeed circuit breaker to ON.
<input type="checkbox"/>	Verify that the display interface is working properly.
<input type="checkbox"/>	Verify through the display interface that the PDU sees the correct number of power modules.
<input type="checkbox"/>	Using a phase rotation meter, verify phase rotation.
<input type="checkbox"/>	Resolve any unexpected alarms.
<input type="checkbox"/>	Configure the date and time through the display interface.
<input type="checkbox"/>	Review the Event Log. Check for abnormalities in the log. Resolve any abnormalities in the log. Clear the Event Log when you are finished.



# Operation

## Display Interface

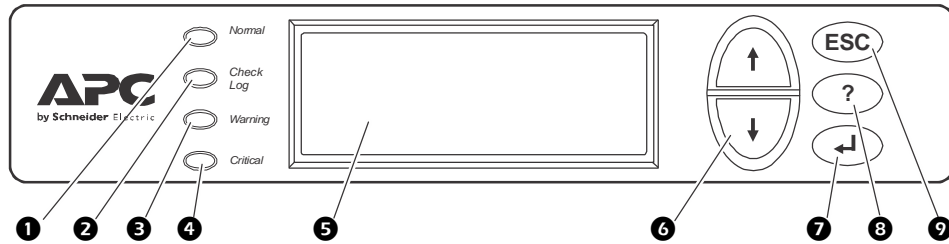

1	Normal LED	Green = no alarms are present.
2	Check Log LED	Green = a new event has been added to the log.
3	Warning LED	Yellow = there are one or more active warning alarms in the system.
4	Critical LED	Red = there are one or more active critical alarms in the system.
5	LCD Screen	Displays alarms, status data, instructional help, and configuration items.
6	UP and DOWN keys	Used to scroll through menu items.
7	ENTER	Press to display new screens, open menu items, and finalize selections.
8	HELP	Press to open content-sensitive help.
9	ESC	Press to return to the previous screen.

## Navigate the display interface

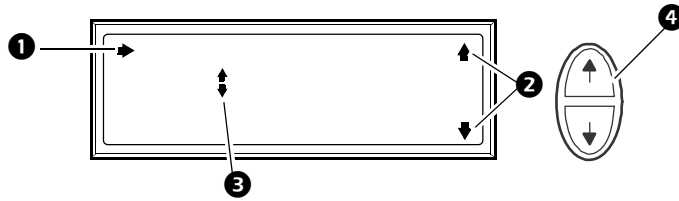

- 1 Selector arrow. Press the UP or DOWN arrow key 4 to move the selector arrow to a menu option or setting. Press the ENTER key to view the selected screen or modify the setting.
- 2 Continue arrows. Indicate that additional screens are available on a menu or status screen. Press the UP or DOWN arrow key to view the additional items.
- 3 Input arrows. Input arrows next to a selected setting indicate that the setting can be modified by pressing the UP or DOWN arrow key. Press the ENTER key to save the change or the ESC key to cancel.
- 4 Press the UP or DOWN arrow key to:
  - a. navigate the selector arrow through the menu prompts
  - b. change the target item
  - c. edit a text string.
 Press the UP or DOWN arrow key to change the character in the text string. Press ENTER to confirm and advance to the next character.

## Top dynamic display

When the system is running, the display interface will automatically scroll through a series of screens showing general information about the PDU and any active alarms on the system.

You can press the UP or DOWN arrow keys to manually scroll through these screens.

Press ENTER at any time to go to the main menu screen (see “Main menu screen” below).

**Note:** If the display interface is inactive for the duration of a user-configured time-out setting, it will return to the top dynamic display.

### Overview Screens (No active alarms)

<b>No Active Alarms</b>
<b>System Date/Time:</b> 28-May-2012 10:37:01

Out	Amps	kW	kVA
L1:	0.0	0.00	00.0
L2:	0.0	0.00	00.0
L3:	0.0	0.00	00.0

<b>Output Voltage</b>
L1: 00V L1-2: 0V
L2: 00V L2-3: 0V
L3: 00V L3-1: 0V

### Overview screen Alarm Shown

<b>Active Alarms: 1 of 15</b>
<b>Communication Lost</b>
<b>With Metering Board</b>
[1.6]

## Main menu screen

The main menu screen is the top-level screen on the display interface. The main menu contains eight submenus that allow you to monitor and configure specific aspects of the system.

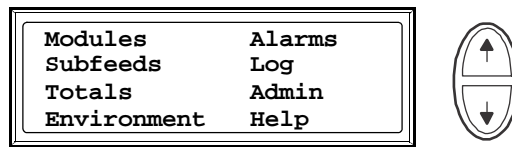

**Note:** Pressing the UP arrow key when the first item in the main menu is selected will result in the cursor moving to the last item on the screen, and vice versa.

## Menu tree

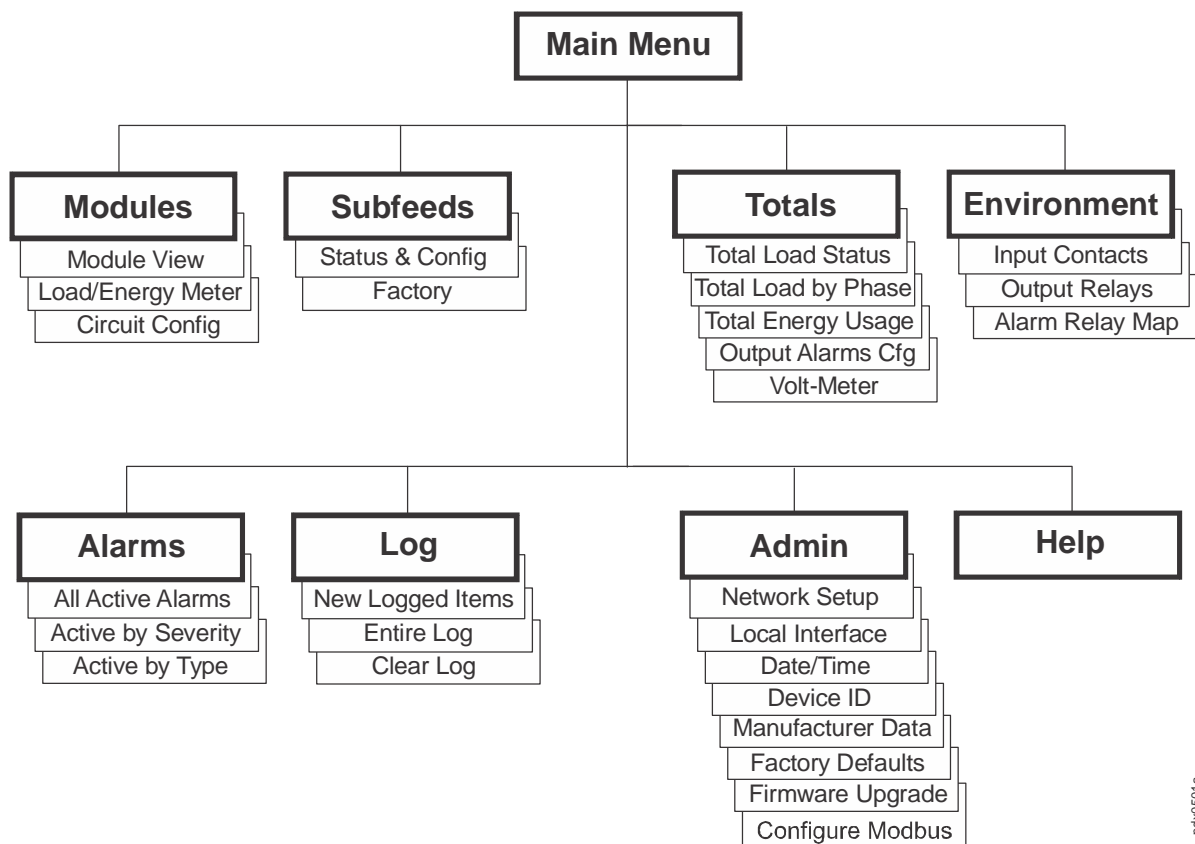

pdw0501a

## Password protection

Certain screens can be configured to require a predefined password in order to allow the user access to those screens. Pressing the ENTER key after selecting a protected screen will result in the user being prompted for the password.

Passwords can be up to eight characters in length. Use the UP or DOWN arrow keys to scroll to different letters in the alphabet, and then press the ENTER key to make a character selection. After you make your selection, the cursor will automatically move to the location of the next character. To end the string, select the underline (“\_”) character and press ENTER.

Your system administrator may configure some screens to be password-protected. The input password will expire after a period of inactivity also configured by the administrator.

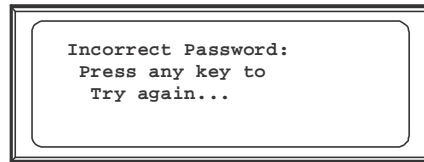
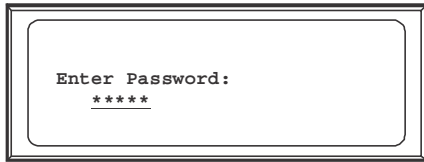

# Modules Submenu

## View Module status

**Path: Main Menu > Modules > Module View > Circuit Details**

- 1 Select Modules on the Main Menu Screen and press ENTER.
- 2 At the next screen, select Module View and press ENTER.
- 3 Press ENTER at the Module number. Scroll through the module list to the specific module and press ENTER.
- 4 To view more information about the module, select Circuit Details and press ENTER.
- 5 For 3-cord modules, select the relevant cable and press ENTER.
- 6 Scroll through the three status screens to view power level, amperage and alarm status of the selected module. Note the warning alarm on L2 in the example below. An alarm status of High!, Low!, Min!, or Max! indicates a reading above or below the threshold level.

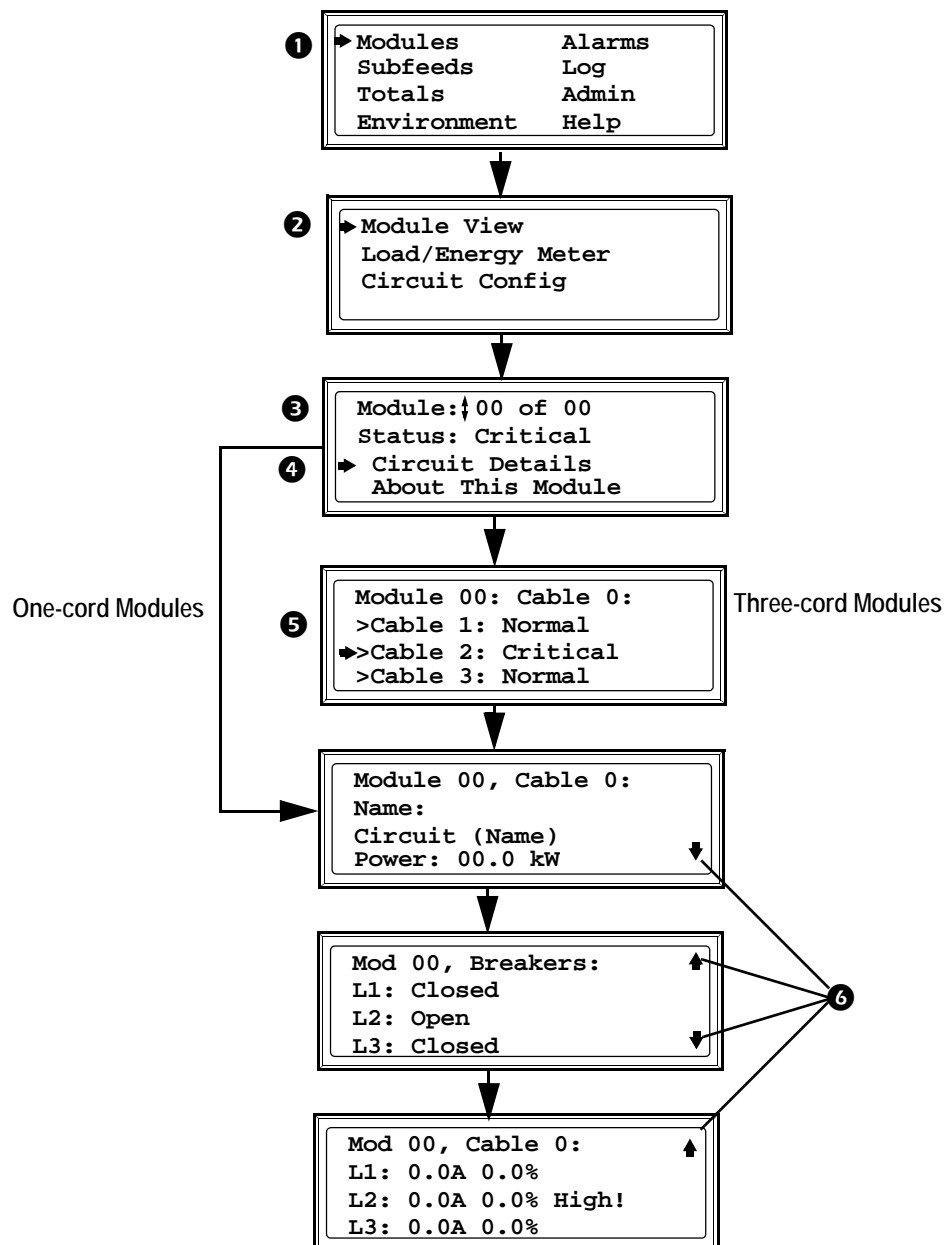

# View Power Distribution Module information

Path: Main Menu > Modules > Module View > Module # > About This Module

- 1 Select Modules on the Main Menu Screen and press ENTER.
- 2 On the next screen, select Module View on and press ENTER.
- 3 Press ENTER at the Module number and use the arrow keys to scroll through the list of modules. When you get to the module you want, press ENTER.
- 4 Select About This Module and press ENTER.
- 5 The selected module is shown in this submenu.  
Select to view either:
  - A Module Mfg Info
  - B Cable Details.
  - C Breaker Ratings

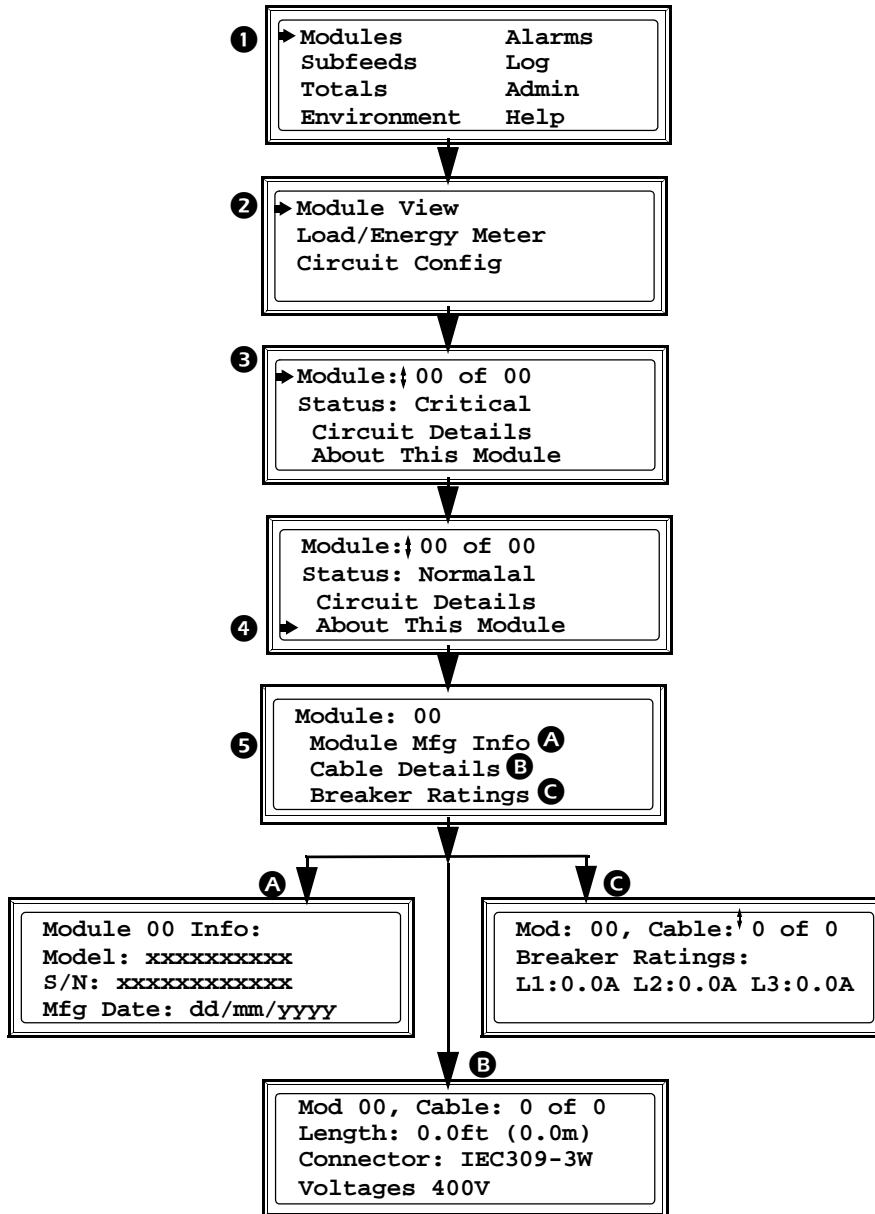

## View circuit status information

**Path: Main Menu > Modules > Load/Energy Meter > Circuit Loading >**

The Load/Energy screens are used for status information on a circuit level and the data is grouped by output cable. Scroll through the list to the specific circuit. The circuit names are stated for identification. See "Configure individual load name, location, and alarm thresholds" on page 13 to set the circuit name.

- ❶ Select Modules on the Main Menu Screen and press ENTER.
- ❷ Select Load/Energy Meter on the submenu screen and press ENTER.
- ❸ Select from the Circuit Loading submenu:
  - Ⓐ Current & Power
  - Ⓑ Percent Loading
  - Ⓒ Energy Usage (kWh)

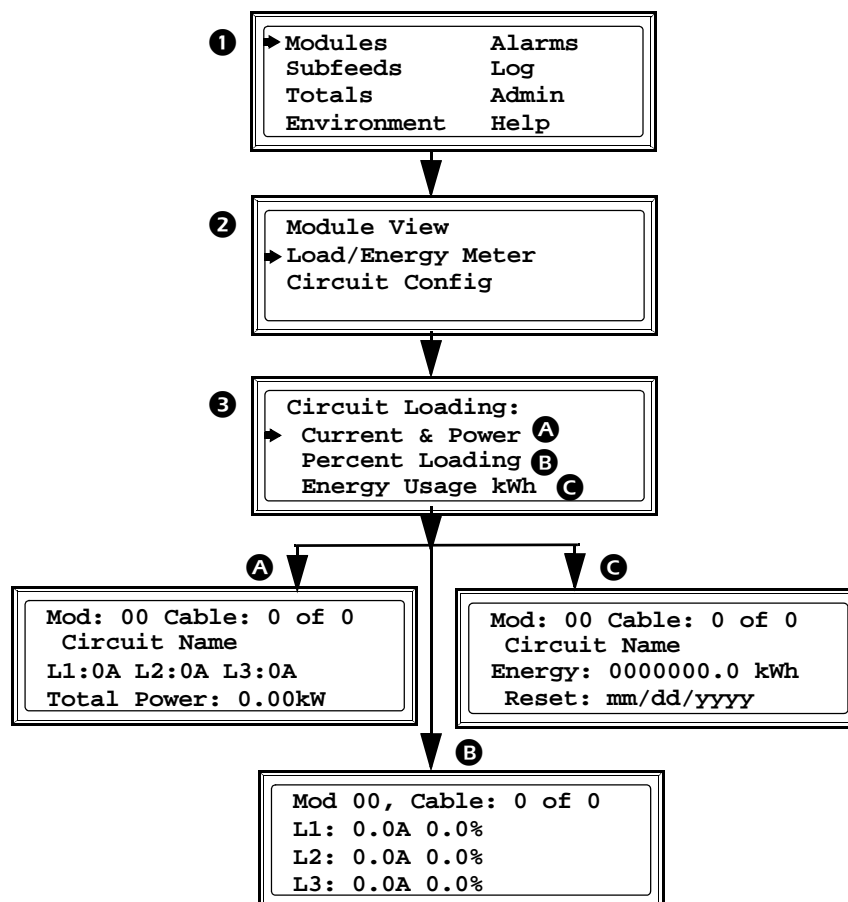

## View or reset module energy usage

**Path: Main Menu > Modules > Load/Energy Meter > Energy Usage > Module # >**

- ❶ Select Modules on the Main Menu Screen and press ENTER.
- ❷ Select Load/Energy Meter on the submenu screen and press ENTER.
- ❸ Select Energy Usage (kWh) and press ENTER.
- ❹ Scroll to the desired Module and Cable. Press ENTER.
- ❺ To reset usage, select Reset and press ENTER. The screens that follow are typically password protected. See "Password protection" on page 8.
- ❻ Select the scope of the reset: only the selected cable, only the selected module, or all modules in the PDU. Press ENTER.
- ❼ Select YES to authorize the reset, or NO to abort. Press ENTER.
- ❽ The screen confirms that the reset has been completed. Press any key to continue.

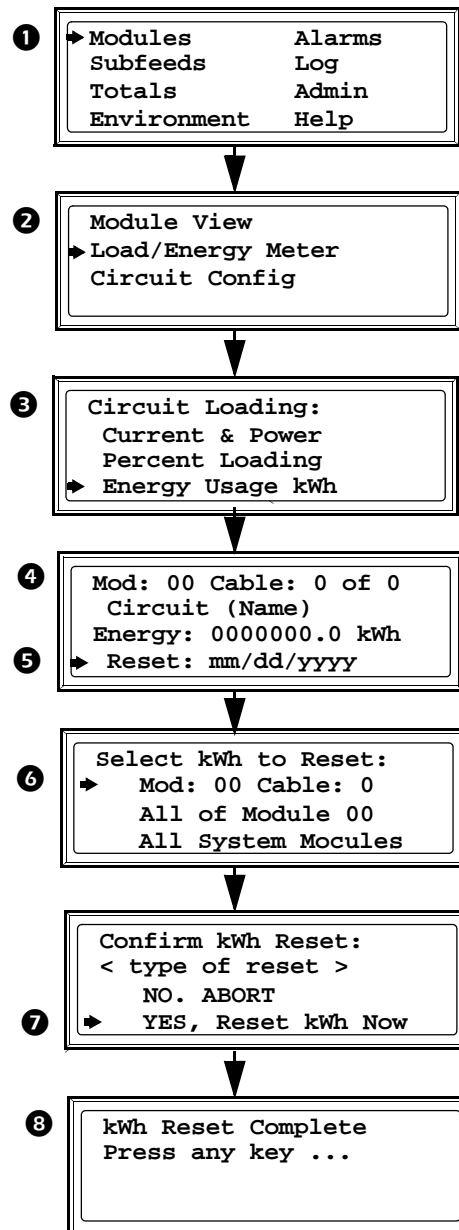



## Configure individual load name, location, and alarm thresholds

**Path: Main Menu > Modules > Circuit Config > Individual Load Cfg > Module # >**

- ❶ From the main menu, select Modules and press ENTER.
- ❷ Use the Down arrow key to move the selector arrow to Circuit Config and press ENTER.
- ❸ Select Individual Load Cfg from the submenu and press ENTER.
- ❹ Scroll to the desired Module and Cable and press ENTER.
  - Ⓐ Move the selector arrow to Name/Location and press ENTER  
Specify the name and location. See “Navigate the display interface” on page 6 for instructions for entering text strings. Press ENTER when the text string is finished.
  - Ⓑ Select Alarm Configuration and press ENTER.  
From the next screen, select Warning Thresholds or Critical Thresholds and press ENTER.  
Scroll to the desired High and Low threshold. Enable or Disable the Alarm for each. Press ENTER.

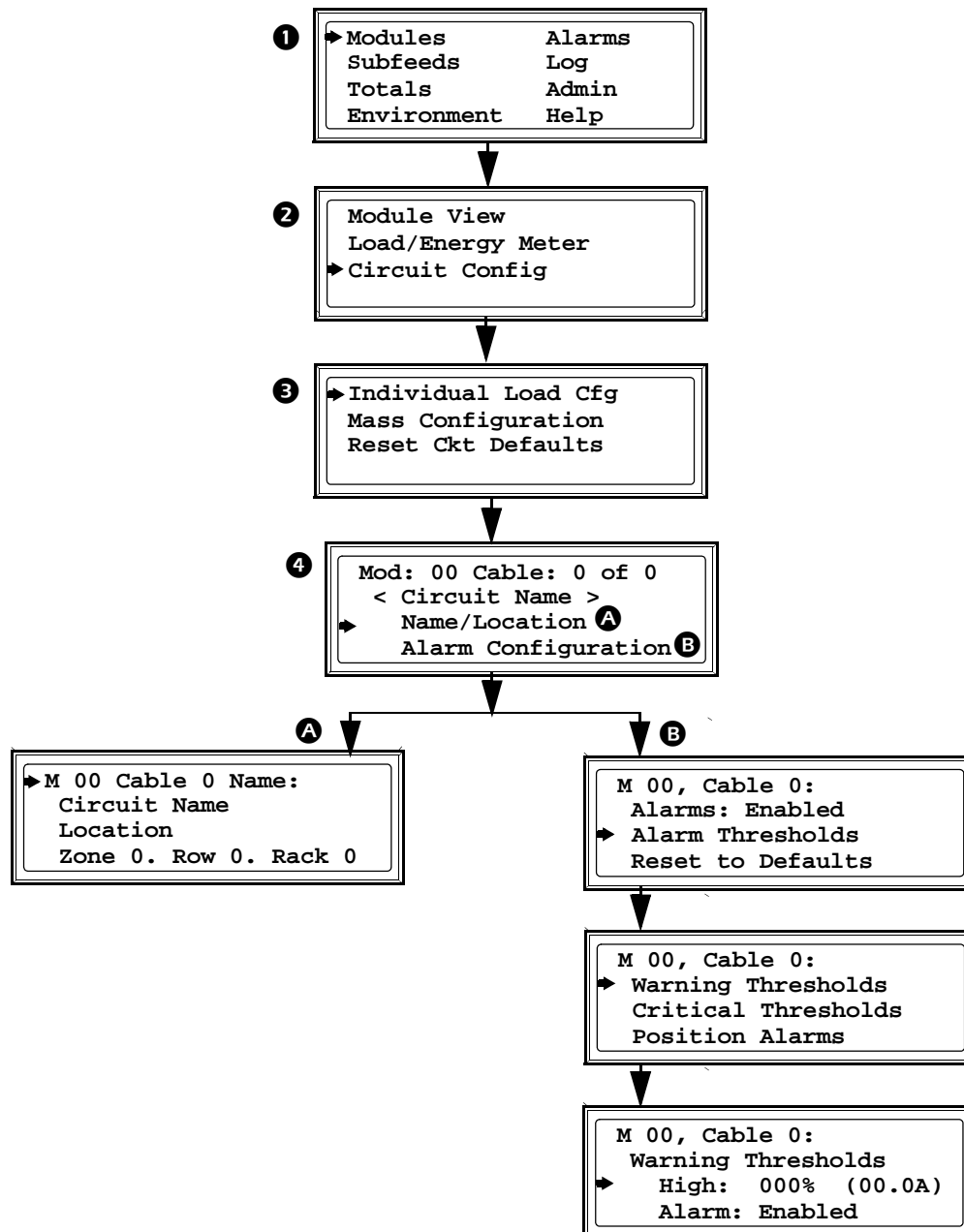

## Enable/Disable alarm thresholds for individual loads

Path: Main Menu > Modules > Circuit Config > Individual Load Cfg > Module # > Alarm Configuration

Refer to the previous task on page 13 for steps 1 through 4 B. Select Alarm Configuration and press ENTER.

- 1 Select Alarms and press ENTER. The input arrow will be activated and you can use the UP or DOWN arrow key to select Enabled or Disabled. Press ENTER when finished to save the setting.

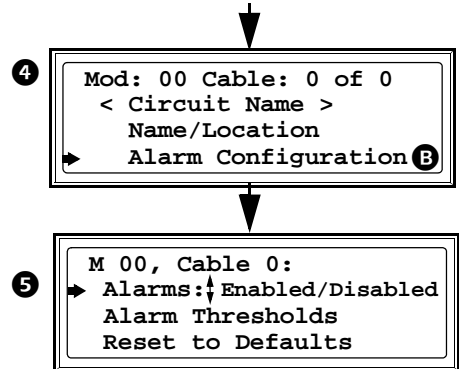

## Enable/Disable module breaker-position alarms

Refer to the task on page 13 for steps 1 through 4 B. Select Alarm Configuration and press ENTER.

- 1 Select Alarm Thresholds and press ENTER.
- 2 Select Position Alarms and press ENTER.
- 3 Move the selector arrow to the breaker you want. At the input arrow, use the UP or DOWN arrow key to select Enabled or Disabled for the selected breaker. Press ENTER to save the setting.

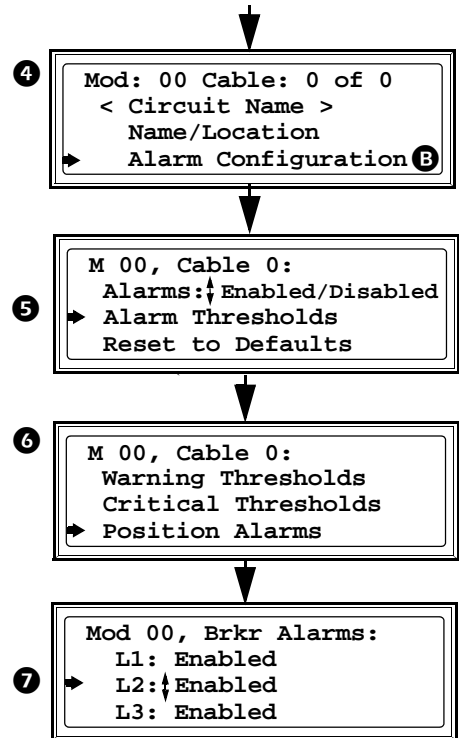

## Reset module alarm settings to default

Refer to the task on page 13 for steps 1 through 4 B. Select Alarm Configuration and press ENTER.

- 1 Select Reset to Defaults and press ENTER.
- 2 Select the Module and Cable you want or All Modules and press ENTER.
- 3 Select YES to authorize the reset, or NO to abort. Press ENTER.

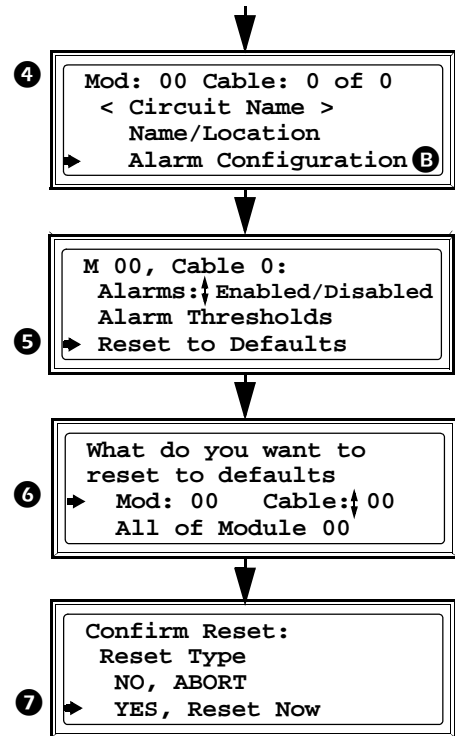

## Mass configuration of alarms

- 1 From the main menu, select Modules and press ENTER.
- 2 Select Circuit Config and press ENTER.
- 3 Select Mass Configuration and press ENTER. The submenu that opens lists three configuration options:
  - A Select Threshold Values and press ENTER.  
 Scroll to the desired High, Low, Min, and Max settings for alarm thresholds.  
 Select Apply to All and press ENTER. This screen is typically password protected. See "Password protection" on page 8.  
 Select YES to apply settings, or NO to abort the process. Press ENTER to save your settings.
  - B Select Threshold Enable and press ENTER. Set Alarms to *On*, *Off*, or \* (no change).  
 Set High, Low, Min, and Max threshold alarms to *On*, *Off*, or \* (no change).  
 Select Apply to All and press ENTER to save your settings.
  - C Select Breaker Position and press ENTER. Set Breaker Position Alarms for *Enabled* or *Disabled*.  
 Select Apply to All and press ENTER to save your settings.

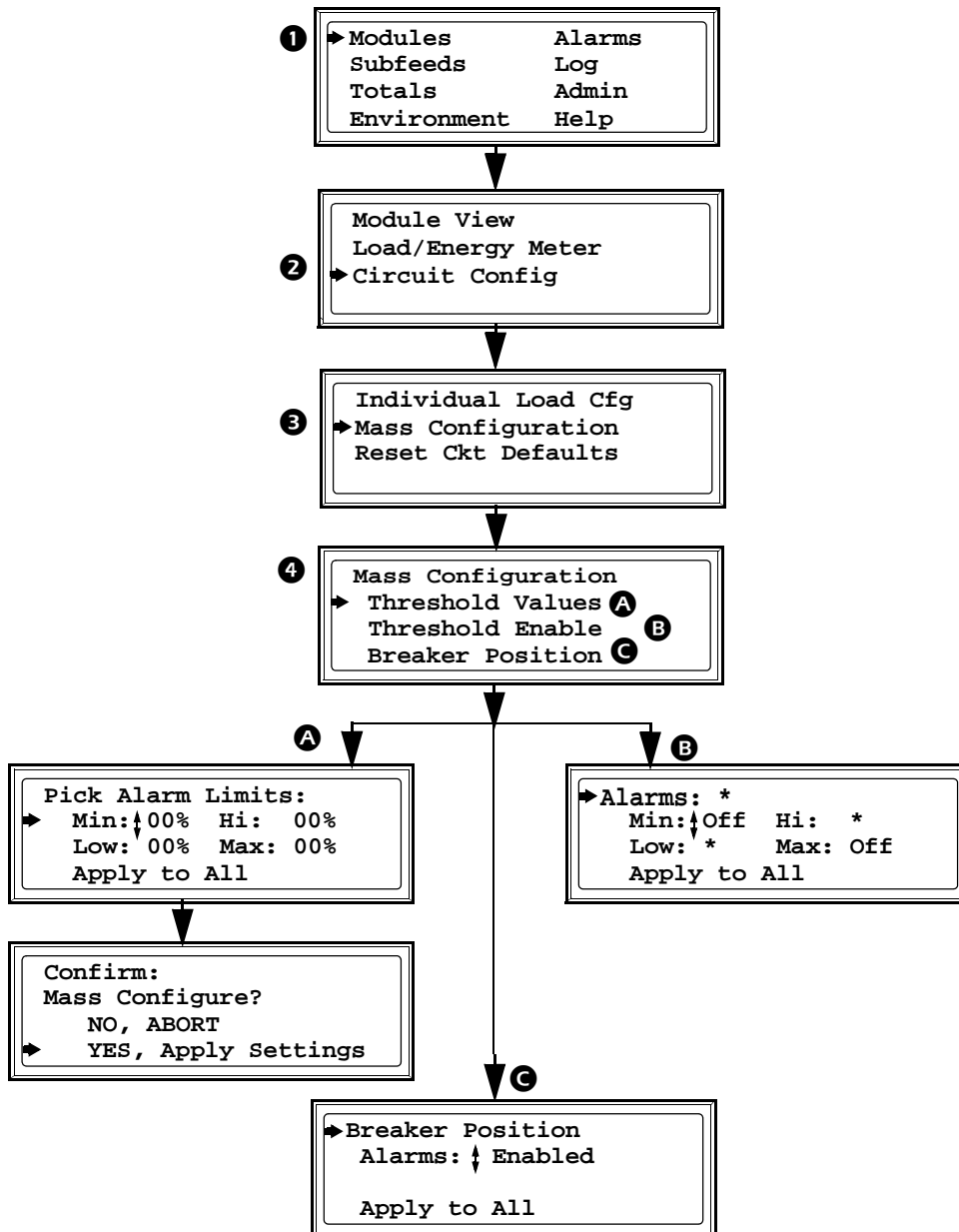

## Reset module cable settings to their default values

- 1 From the main menu, select Modules and press ENTER.
- 2 Select Circuit Config and press ENTER.
- 3 Select Reset Ckt Defaults and press ENTER. The following screens are typically password protected. See "Password protection" on page 8.
- 4 Select the scope of the reset: All Settings or Only Alarm Settings. Press ENTER.
- 5 Select YES to apply the reset, or NO to abort the reset. Press ENTER.

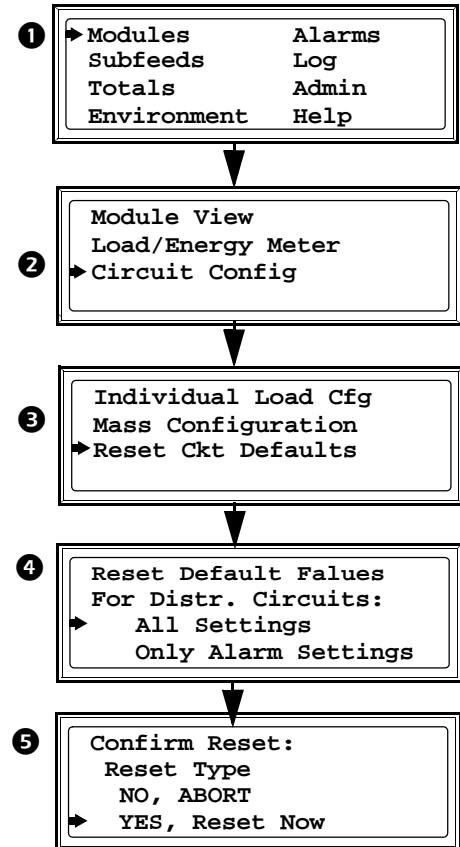

# Subfeeds Submenu

View information concerning the operational status of subfeeds, if installed. Also, set and reset alarm thresholds for the subfeeds.

**Note:** If your Modular PDU does not support subfeeds, ignore this section and all references to subfeeds.

## View general subfeed information

- 1 Select Subfeeds from the main menu and press the ENTER key.
- A If there are no subfeeds installed in your PDU, this screen A will be displayed after you select Subfeeds from the main menu.
- B To view general subfeed information, select Factory B and press ENTER. Scroll to the desired Subfeed to view its installation status and breaker rating.

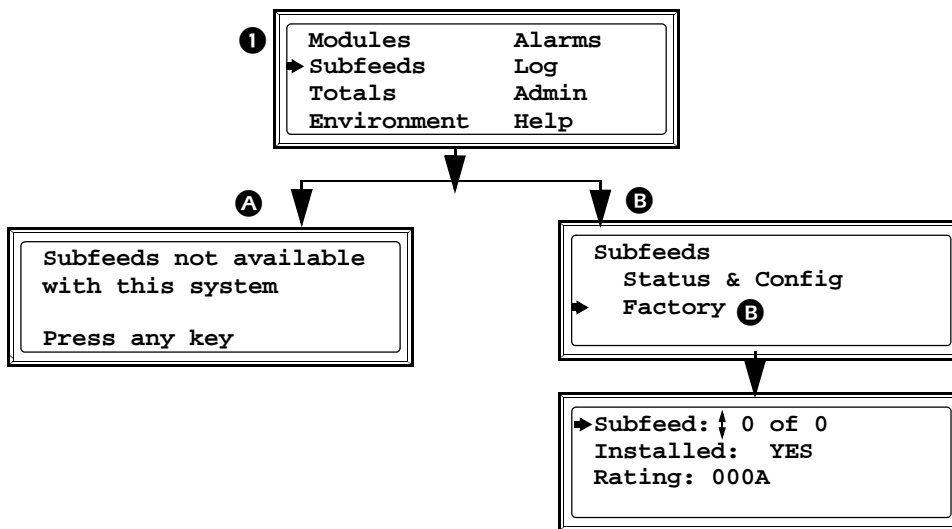

## View subfeed operational status and configure name/location

- 1 Select Subfeeds from the main menu and press the **ENTER** key.
- 2 Select Status & Config and press **ENTER**.
- 3 Scroll to the desired Subfeed. The Subfeed Name will reflect your selection.
  - A Select Status. The status entry may be *Normal*, *Warning*, or *Critical*. Press **ENTER** to view the current, power, energy usage, and operational status of the subfeed.
  - B Select Configuration and press **ENTER**.  
 Select Name/Location and press **ENTER**.  
 Specify the Name and Location of the subfeed.  
 Scroll through the characters. Press **ENTER** to select the displayed character and proceed to the next character. When you are finished entering the characters, press **ENTER** to save.

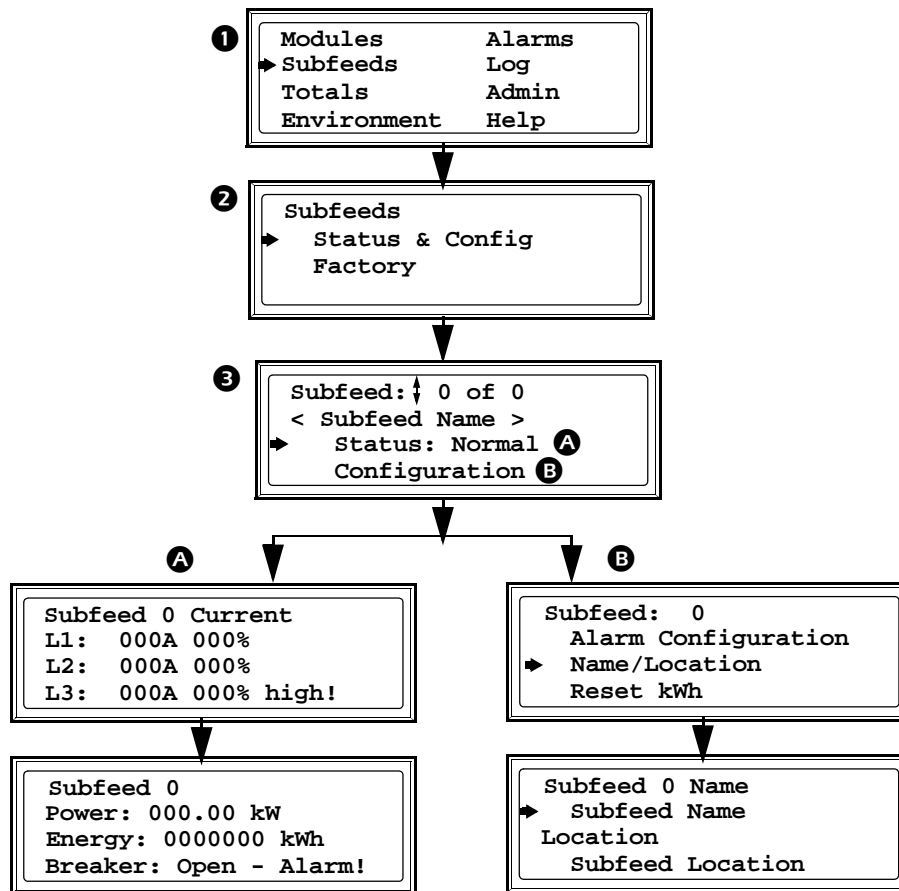

## Configure warning and critical alarm thresholds for subfeeds

- 1 Select Subfeeds from the main menu and press the ENTER key.
- 2 Select Status & Config and press ENTER.
- 3 Scroll to the desired Subfeed. Select Configuration and press ENTER.
- 4 Select Alarm Configuration and press ENTER.
- 5 Select Alarm Thresholds and press ENTER.
- 6 Select Warning Thresholds **A** or Critical Thresholds **B** and press ENTER.
  - A** Scroll to the desired High and Low warning thresholds and set Alarm as *Enabled* or *Disabled* for each of these thresholds. Press ENTER to save the settings.
  - B** Scroll to the desired Min (minimum) and Max (maximum) critical thresholds and set Alarm as *Enabled* or *Disabled* for each of these thresholds. Press ENTER to save the settings.

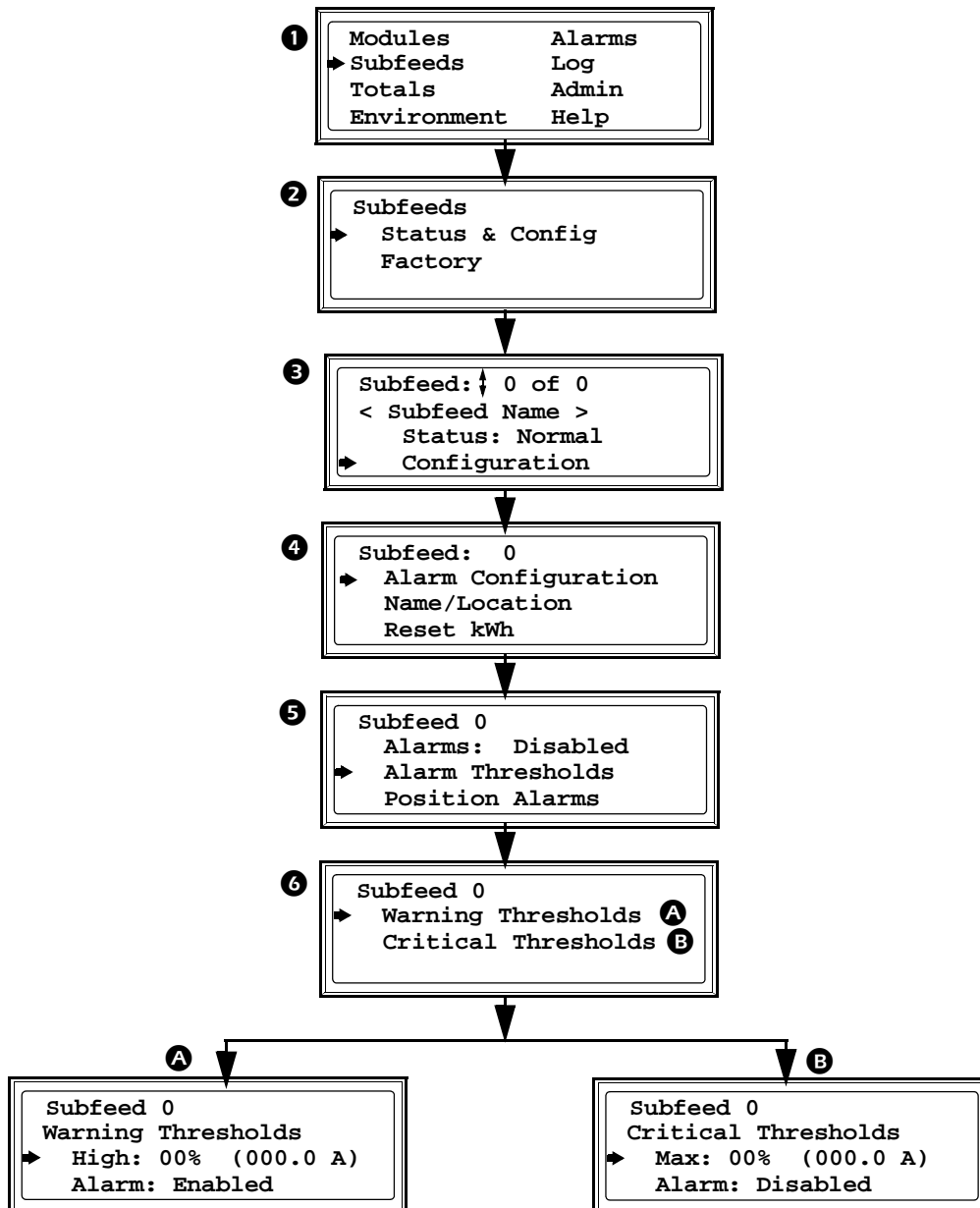



## Enable or disable alarm thresholds and alarms for subfeed breakers

- 1 Select Subfeeds from the main menu and press the ENTER key.
- 2 Select Status & Config and press ENTER.
- 3 Scroll to the desired Subfeed. Select Configuration and press ENTER.
- 4 Select Alarm Configuration and press ENTER.
- 5
  - A To configure alarm thresholds, select Alarms and set to *Enabled* or *Disabled*. Press ENTER.  
**Note:** When *Disabled*, this setting inhibits ALL alarms pertaining to the selected subfeed.
  - B To configure breaker position alarms, select Position Alarms and press ENTER. Select Alarm and set to *Enabled* or *Disabled*.

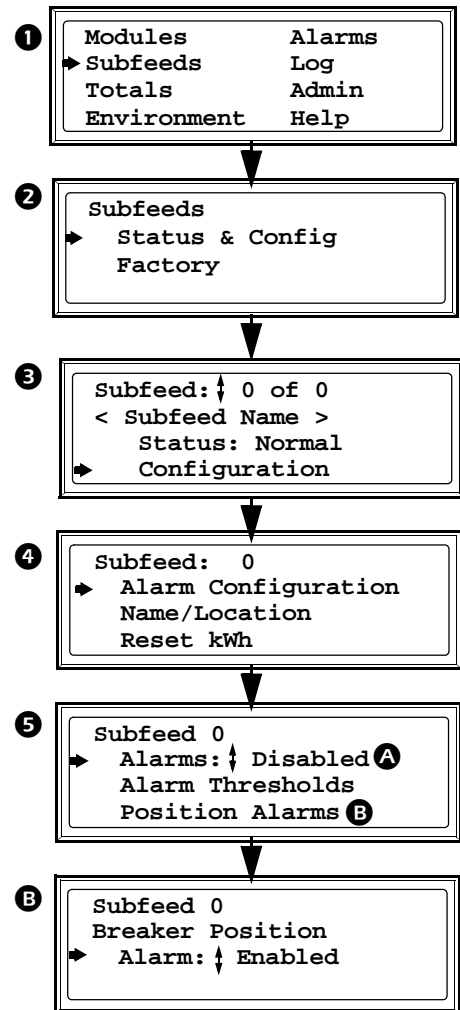

## Reset subfeed energy usage

To reset subfeed energy usage, repeat steps 1 through 3 of the previous task.

- 1 Select Reset kWh and press the ENTER key.
- 2 Select YES to apply the reset, or NO to abort. Press ENTER.
- 3 The confirmation screen confirms the reset was successful. Press any key to continue.

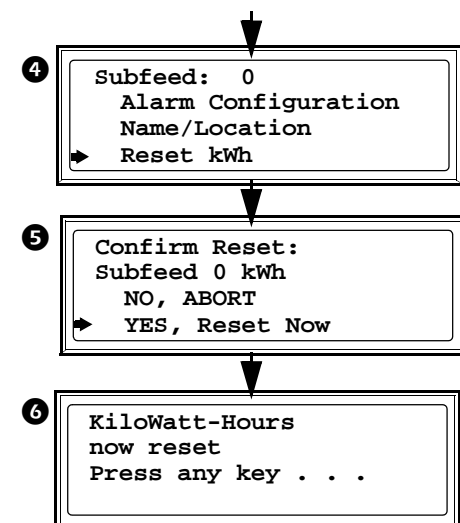

# Totals Submenu

The Totals submenu allows you to view comprehensive information concerning the operational status of the PDU. It also allows you to set and reset alarm thresholds for the entire system.

## View total load status

- 1 Select Totals from the main menu and press ENTER.
- 2 Select Total Load Status and press ENTER.
- 3 Status can be *Normal*, *Warning*, or *Critical*. View power factor and load (in kW and kVA).

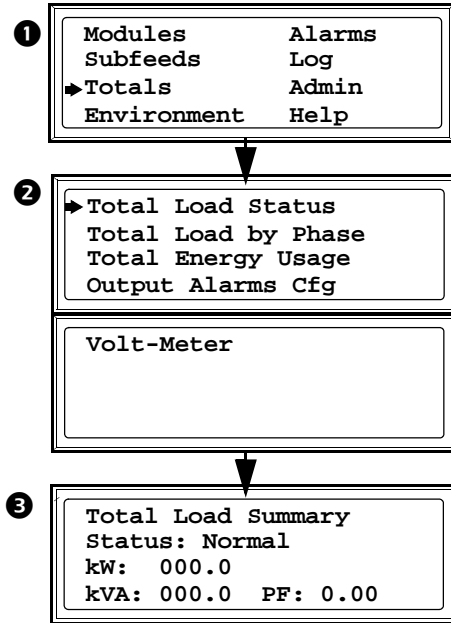

## Total output current by phase

- 1 Select Totals from the main menu and press ENTER.
- 2 Select Total Load by Phase and press ENTER.
- 3 View total output current and power factor for each phase. *High!*, *Low!*, *Min!* or *Max!* indicates a reading above or below the threshold level.

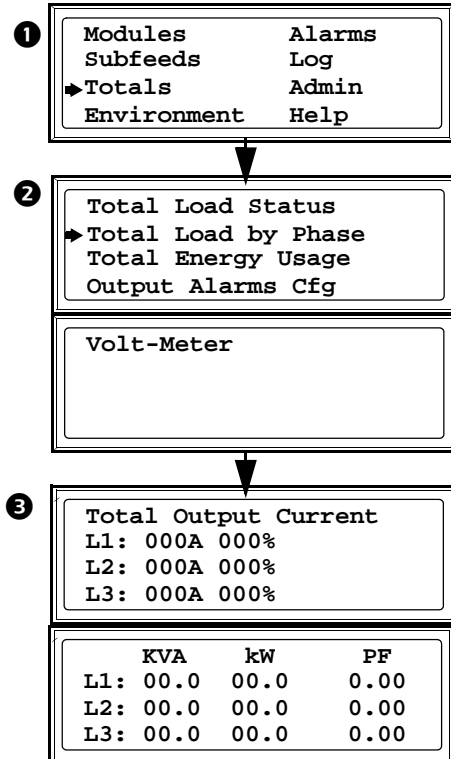

## View or reset total energy usage by phase

- 1 Select Totals and press ENTER.
  - 2 Select Total Energy Usage and press ENTER.
  - 3 View Total Energy Usage in kWh.
    - A Select Usage by Phase and press ENTER to view total energy usage by phase.
    - B Select Reset and press ENTER to reset the total KiloWatt-hours energy usage to zero.
- Note:** The date of the last reset is shown. The next screens may be password protected. Select YES to apply the reset, or NO to abort. Press ENTER.  
The next screen confirms that the reset has been completed. Press any key to continue.

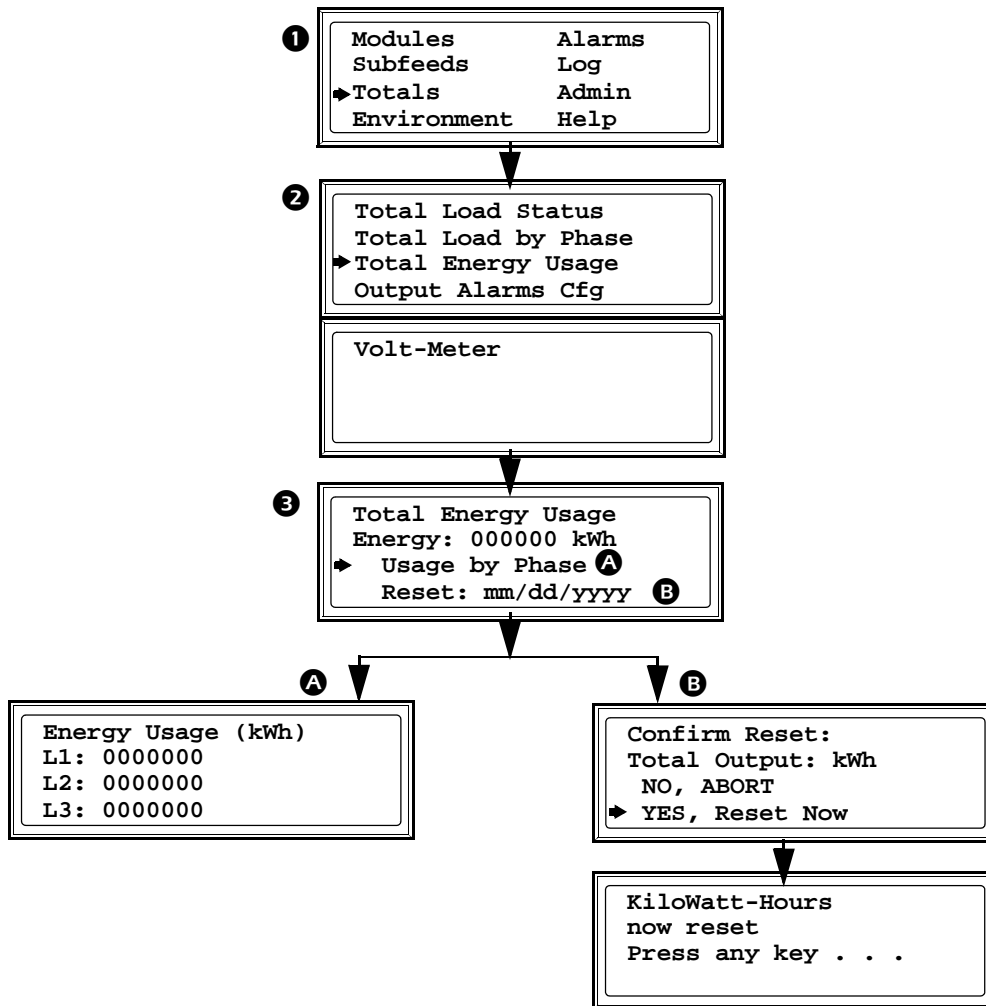

## View total voltage and frequency

- 1 Select Totals and press ENTER.
- 2 Select Volt-Meter on the submenu and press ENTER.
- 3 View frequency by phase.

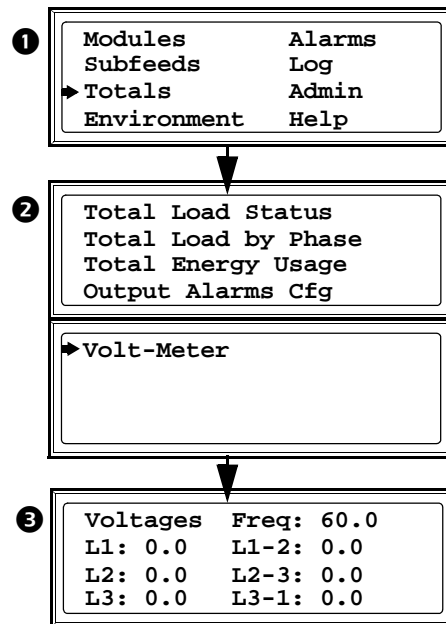

## View distribution panel settings

- 1 Select Totals and press ENTER.
- 2 Select Output Alarms Cfg and press ENTER.
- 3 Select Nominal Settings and press ENTER.
- 4 View Voltage, Frequency, and Ampere Rating for the distribution panel.

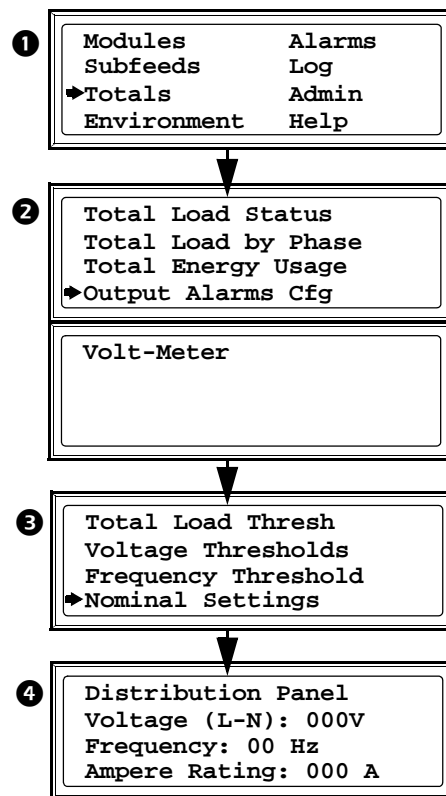

## Configure critical and warning alarm thresholds for total output current

- 1 Select Totals and press ENTER.
- 2 Select Output Alarms Cfg and press ENTER.
- 3 Select Total Load Thresh and press ENTER.
- 4 Select the Total Current Alarm threshold you want to configure.
  - A Select Warning Thresholds and press ENTER.  
Scroll to the desired High and Low warning thresholds and set Alarm as *Enabled* or *Disabled* for each of these thresholds. Press ENTER.
  - B Select Critical Thresholds and press ENTER.  
Scroll to the desired Max and Min critical thresholds and set Alarm as *Enabled* or *Disabled* for each of these thresholds. Press ENTER.

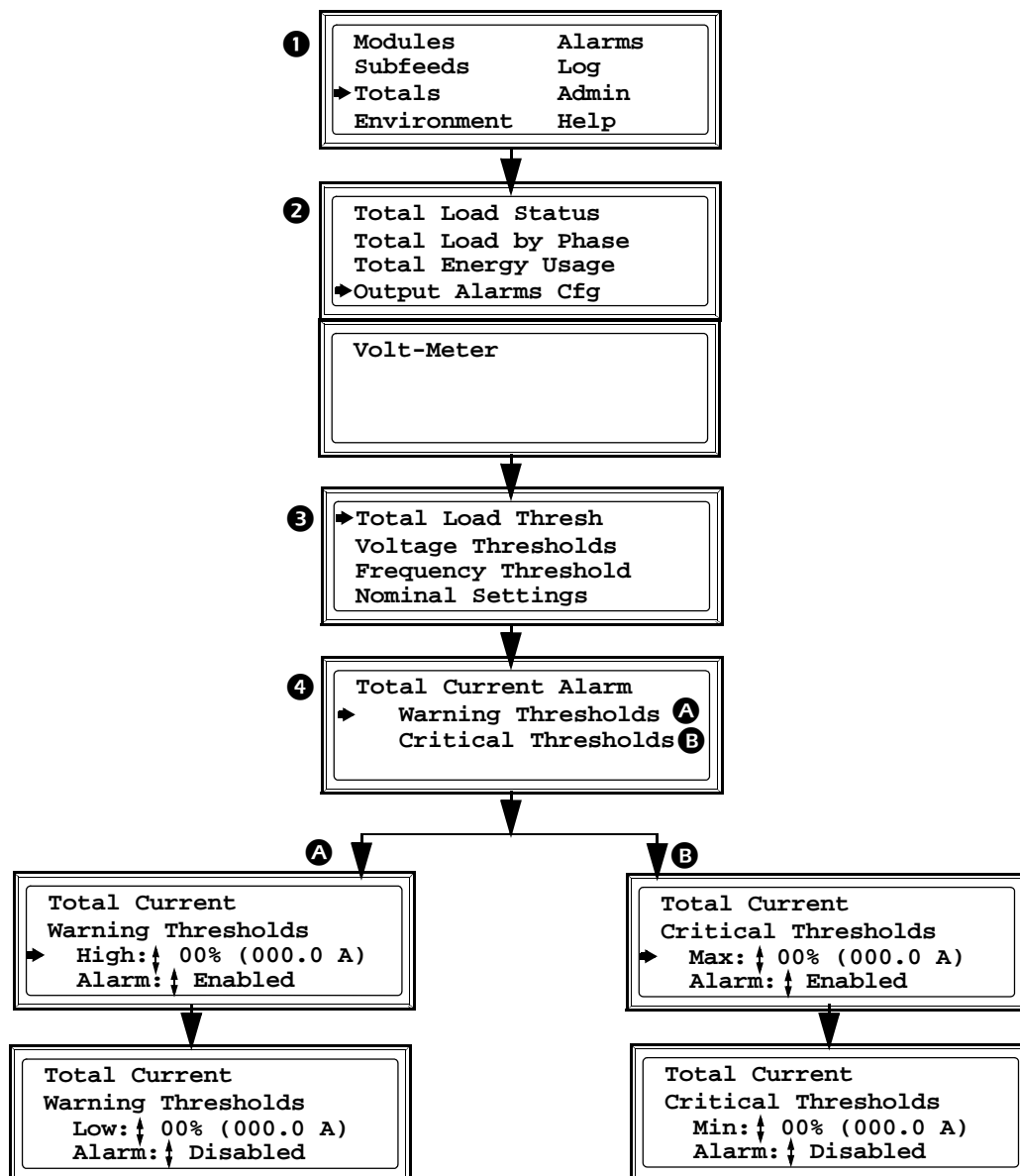

## Configure critical and warning alarm thresholds for total output voltage

- 1 Select Totals and press ENTER.
- 2 Select Output Alarms Cfg and press ENTER.
- 3 Select Voltage Thresholds and press ENTER.
- 4 Select the Output Voltage Alarm threshold you want to configure.
  - A Select Warning Thresholds and press ENTER.  
Scroll to the desired High and Low warning thresholds and set Alarm as *Enabled* or *Disabled* for each of these thresholds. Press ENTER.
  - B Select Critical Thresholds and press ENTER.  
Scroll to the desired Max and Min critical thresholds and set Alarm as *Enabled* or *Disabled* for each of these thresholds. Press ENTER.

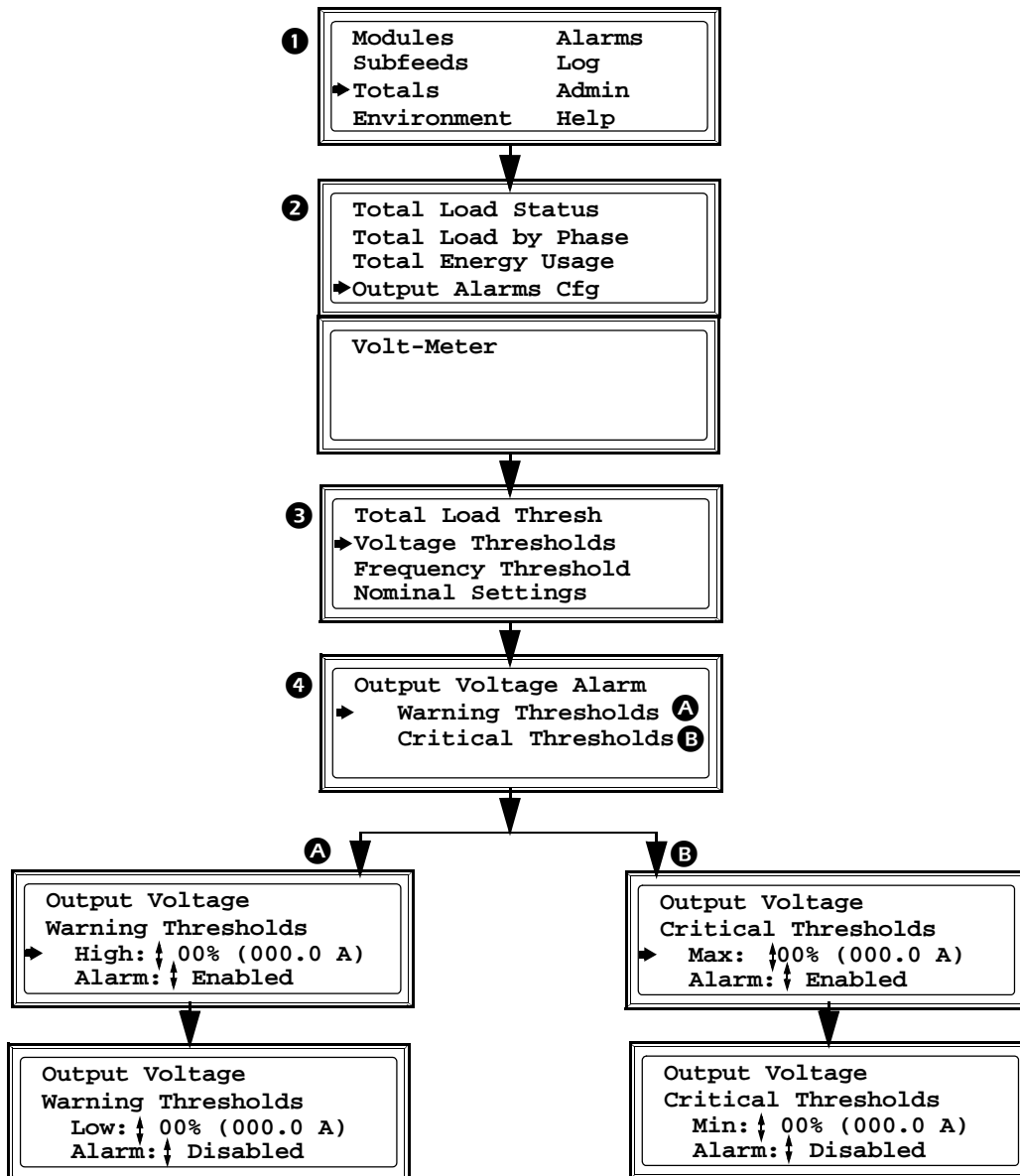

## Configure the nominal frequency range to affect alarm conditions

- 1 Select Totals and press ENTER.
- 2 Select Output Alarms Cfg and press ENTER.
- 3 Select Frequency Threshold and press ENTER.
- 4 Set Range for +/- 9.0 Hz, +/- 5.0 Hz, +/- 4.0 Hz, +/- 3.0 Hz, +/- 2.0 Hz, +/- 1.5 Hz, +/- 1.0 Hz, +/- 0.5 Hz, +/- 0.2 Hz, or Disabled. Press ENTER.

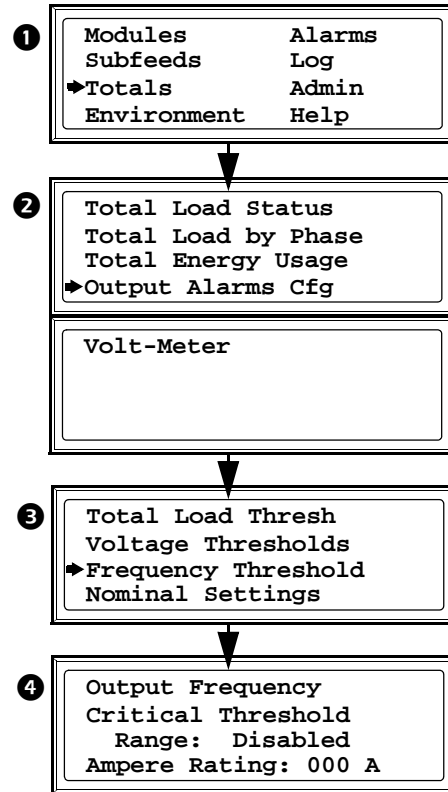

## Environment Submenu

### View the status or configure input contact settings

- 1 Select Environment from the main menu and press the ENTER key.
- 2 Select Input Contacts and press ENTER.
- 3 Scroll to the desired Input Contact. Up to 4 input contacts can be installed. The contact name reflects your selection. Status can be *Normal*, *Warning*, or *Critical*.
  - A Select Status and press ENTER.

View the Normal condition (*Open* or *Closed*) of the contact and the actual State of the contact (*Open* or *Closed*).

Note: When Normal and State are the same, the Status is *Normal*. When Normal and State are different, an alarm condition occurs.
  - B Select Configuration and press ENTER.

Set Alarms as *Enabled* or *Disabled*.

Set Severity as *Warning* or *Critical*.

Set Normal state as *Open* or *Closed*.

Select Name/Location and press ENTER.

Specify the Name and Location of the input contact by scrolling through the alphabet characters.

Press ENTER to select the displayed character and proceed to the next character. To end the string, select the underline (“\_”) character and press ENTER.

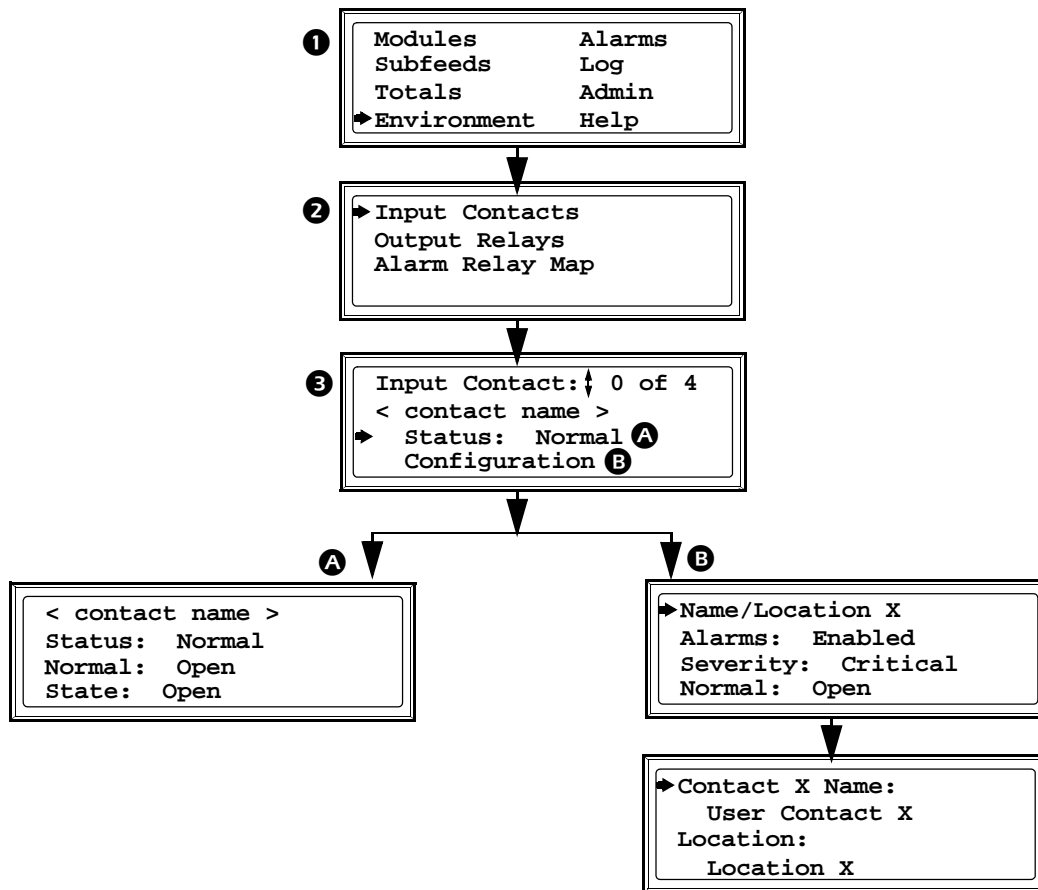

## Configure output relay settings

- 1 Select Environment from the main menu and press the ENTER key.
- 2 Select Output Relays and press ENTER.
- 3 Scroll to the desired Output Relay. Up to 4 output relays can be installed. The contact name reflects your selection. Status can be *Open* or *Closed*. Select Configuration and press ENTER.
- 4 Specify the Name of the output relay by scrolling through alphabet characters. Press ENTER to select the displayed character and proceed to the next character. To end the string, select underline (“\_”) and press ENTER. Set Normal state as *Open* or *Closed*. Press ENTER.

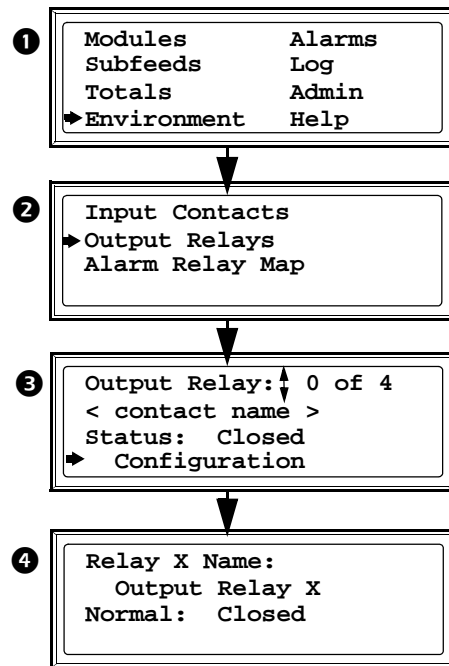



## Configure the alarm relay map

- 1 Select Environment from the main menu and press ENTER.
- 2 Select Alarm Relay Map and press ENTER.
- 3 Select a *category*: Environment, System Output, or Breaker Modules. Categories are system specific. Press ENTER.  
Select an *alarm condition* for the selected category ( **A**, **B**, or **C** ). Press ENTER.

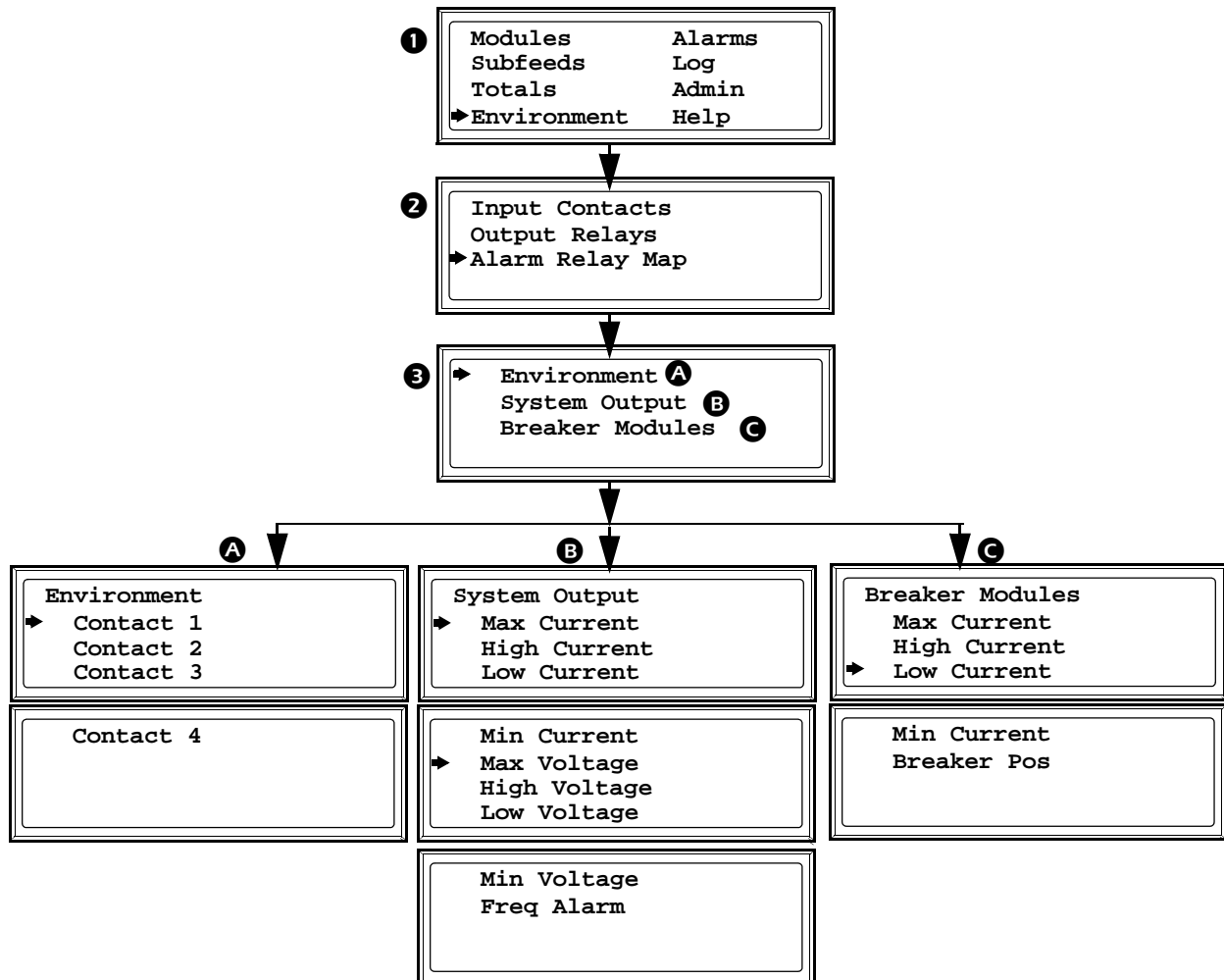

- 1 From **B**, select the Relay or Relays (*R1*, *R2*, *R3*, and *R4*) that will be activated when the specified alarm condition occurs. Press ENTER. Both *category* and *alarm condition* can be changed from this screen to allow you to configure the entire map using this screen.

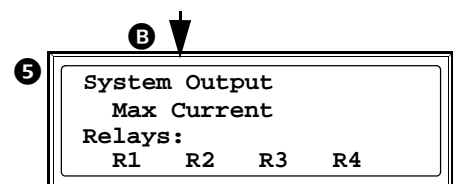

# Alarms Submenu

## View alarms

- 1 Select Alarms from the main menu and press the ENTER key.
- 2 Select from the submenu:
  - A Select All Active Alarms and press ENTER.  
The most recent Active Alarm is displayed. Press the ENTER or UP key to go to the next alarm in sequence. Press the DOWN key to go to the previous alarm in sequence.  
When there are no active alarms, the No Alarms screen displays.
  - B Select Active by Severity and press ENTER.  
Select Warning or Critical.  
0 is the number of active alarms of that type. Press ENTER.  
The most recent Active Alarm of the severity you chose is displayed. Press the ENTER or UP key to go to the next alarm in sequence.  
Press the DOWN key to go to the previous alarm in sequence.  
If there are no active alarms of the selected severity, the next screen will inform you.
  - C Select Active by Type and press ENTER.  
Select Distribution, or Environment. Press ENTER.  
The most recent Active Alarm of the type you chose is displayed. Press the ENTER or UP key to go to the next alarm in sequence. Press the DOWN key to go to the previous alarm in sequence.  
If there are no active alarms of your selected type, the next screen will inform you.

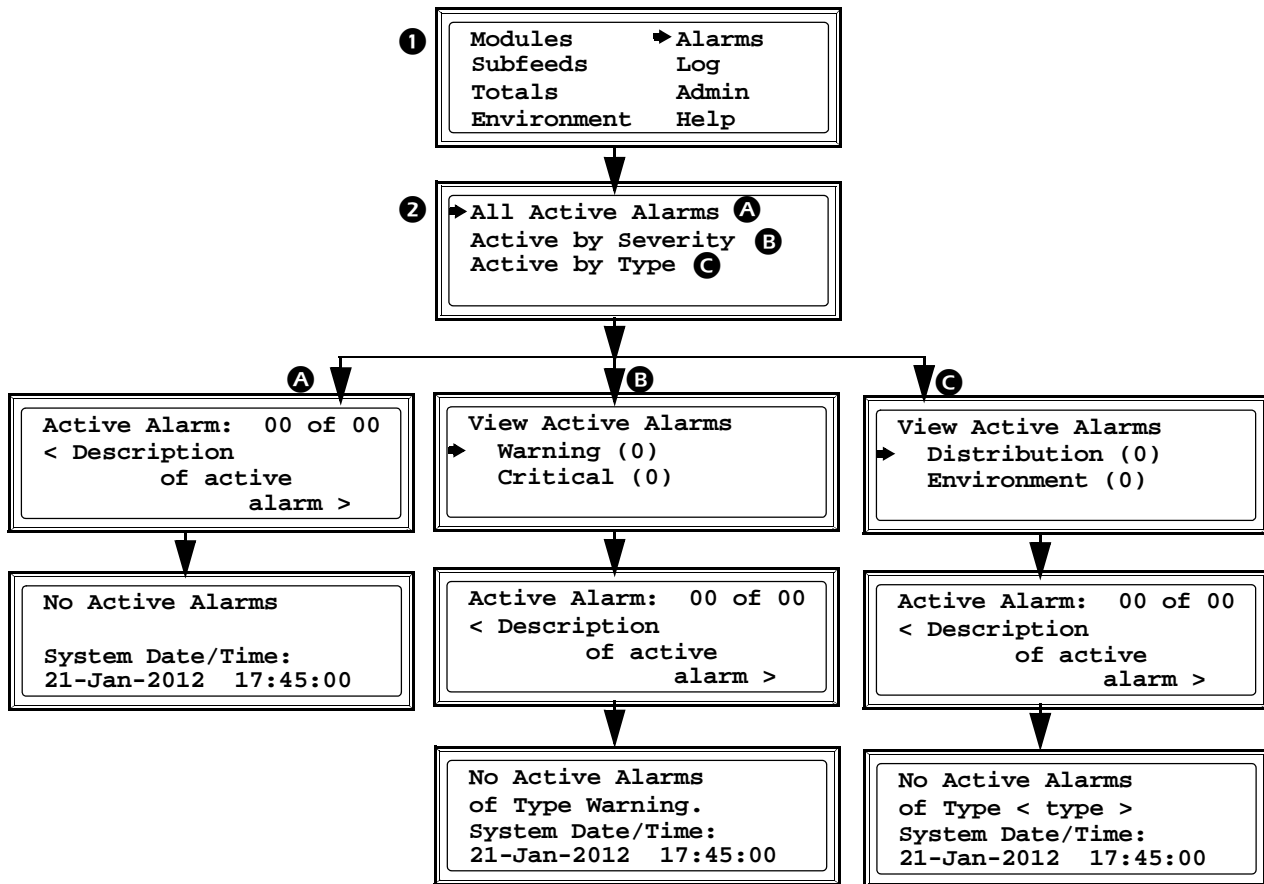

# Log Submenu

View or clear log items

- 1 Select Log from the main menu and press the ENTER key.
- 2 Select from the submenu:
  - A Select View New Logged Items and press ENTER. This results in the display of all events logged since your last viewing. The most recent item is displayed first.  
**Note:** All logged items include a time stamp. Press the ENTER or UP key to go to the next item in sequence. Press the DOWN key to go to the previous item in sequence. The No Logged Items screen displays when there are no new logged items.
  - B Select View Entire Log and press ENTER. This results in the display of all events logged since the log was last cleared. The most recent item is displayed first. Press the ENTER or UP key to go to the next item in sequence. Press the DOWN key to go to the previous item in sequence. The No Logged Items screen displays when there are no new logged items.
  - C Select Clear Entire Log and press ENTER. The following screens are typically password protected. Select YES to clear the log, or NO to cancel the process. Press ENTER. This screen confirms that the log has been cleared. Press any key to continue.

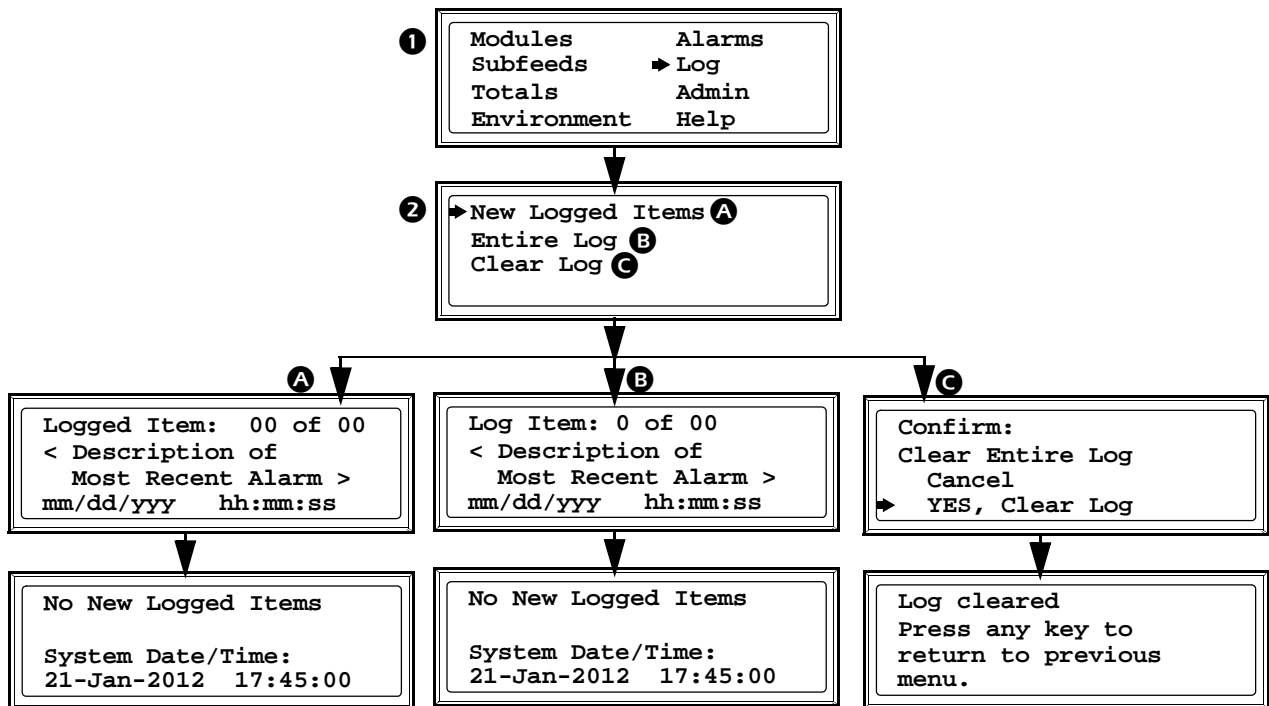

# Admin Submenu

## Configure the network address settings

1 Select Admin from the main menu and press ENTER.

2 Select Network Setup and press ENTER.

3 View network address information. Select Mode and press ENTER.

4 Select **A** to configure the Fixed IP Address and **B** to configure DHCP Only, BOOTP Only, or DHCP & BOOTP and

**A** Select Fixed IP Address and press ENTER. Specify the IP, Subnet Mask (SM), and Gateway (GW) addresses. Select Use Fixed Address and press ENTER.

**B** Select DHCP Only, BOOTP Only, or DHCP & BOOTP and press ENTER. Select YES to reboot with new address, or NO to revert to the previous address. Press ENTER.

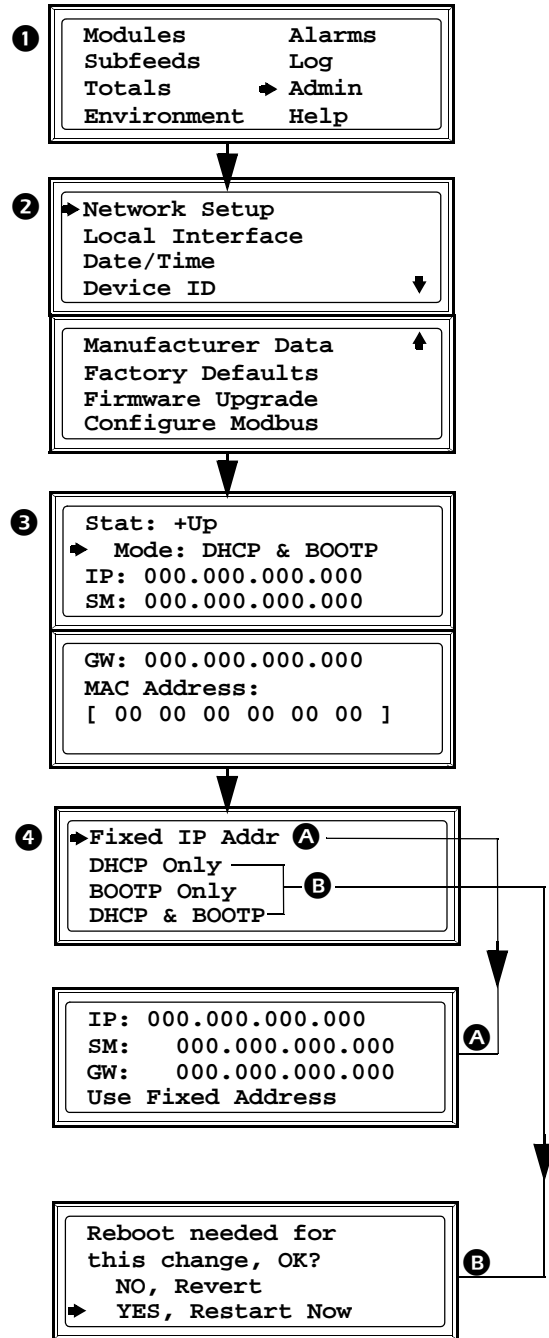

## Upgrade metering board firmware

**Note:** Firmware versions 3.7.1 and later will auto-update.

- 1 Select Admin from the main menu and press **ENTER**.
- 2 Select Firmware Upgrade and press **ENTER**.
- 3 Select YES to download firmware, or NO to abort the process. Press **ENTER**.
- 4 If YES is selected, this screen confirms that the firmware is being upgraded. Wait for the process to conclude and then press any key to continue

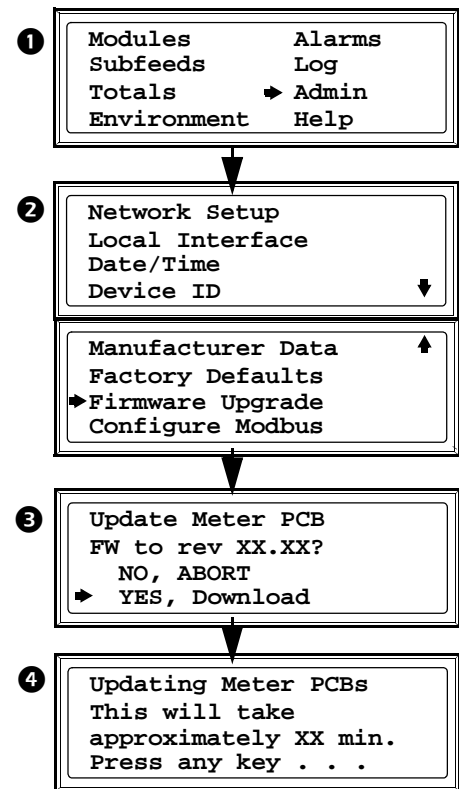

## Change the password

- 1 Select Admin from the main menu and press **ENTER**.
- 2 Select Local Interface and press **ENTER**.
- 3 Select Local Password and press **ENTER**.
- 4 Specify the new Password by scrolling through alphabet characters using the **UP** or **DOWN** arrow keys. Press **ENTER**. You can also change the Timeout period. Scroll to your numerical selection and press **ENTER**.

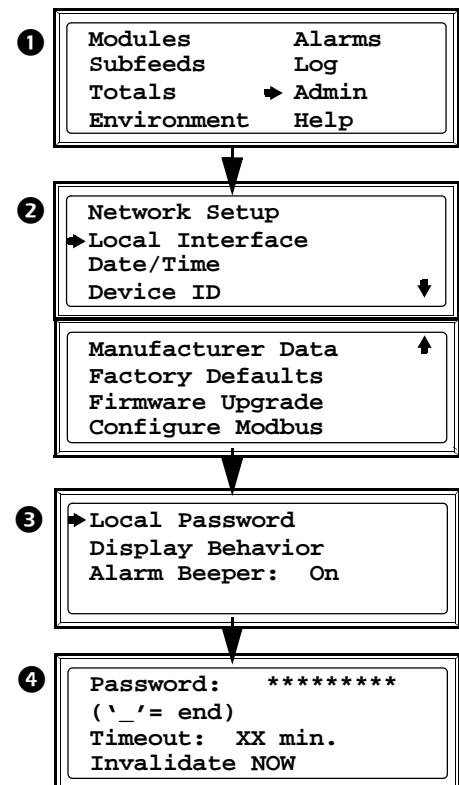

**Note:** Characters are presented in the following sequence: \_, (space), A, B, C, D, E, etc. Press the **ENTER** key to select the displayed character and proceed to the next character. Passwords can be up to eight characters in length. If your password is less than eight characters, end with underline character ("\_").

## Change display interface settings

- 1 Select Admin from the main menu and press ENTER.
- 2 Select Local Interface and press ENTER.
- 3 Select Display Behavior and press ENTER.
- 4 Scroll to change these settings: Press ENTER after making your selection to save it.
  - A Contrast can be set between 1 (low) and 7 (high).
  - B Key Click can be set to *On* or *Off*.
  - C Beeper Volume can be *Low*, *Med*, *High*, or *Off*.
  - D The Check Log Light option allows you to change the types of logged items that cause the Check Log LED to illuminate. Select Check Log Light and press ENTER. Scroll to choose *Info* (informational), *Warning*, *Critical*, or *Disabled* and press ENTER. Your selection represents the *minimal* type of event monitored by the Check Log LED.

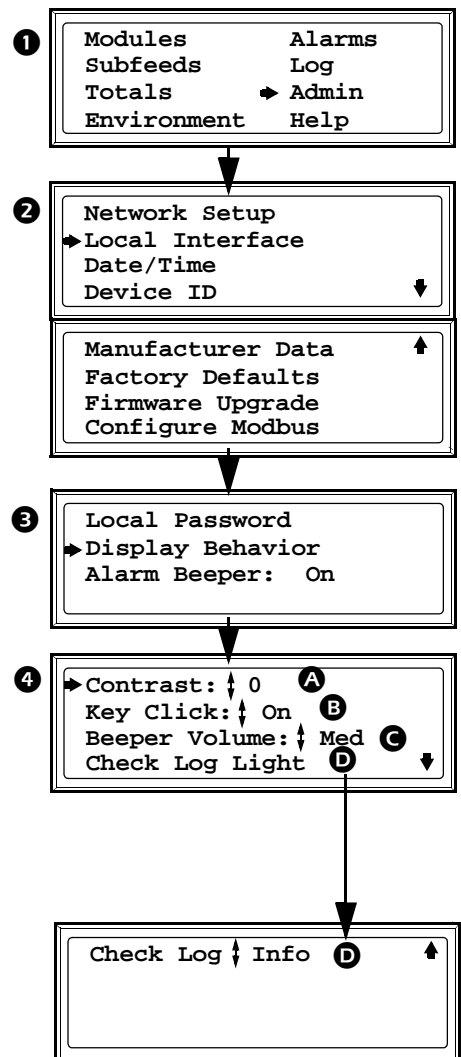

## Change the date and time on the display interface

- 1 Select Admin from the main menu and press ENTER.
- 2 Select Date/Time and press ENTER.
- 3 Select the setting you want to change and press ENTER.
  - A You can change how the date is presented by scrolling through the Format options.
  - B The Date screen may be password protected depending on your system. Scroll through the screen that opens to set the new Month, Day, and Year. Select Apply New Date and press ENTER to save your changes.
  - C The Time screen may be password protected depending on your system. Scroll through the screen that opens to set the new Time. Select Apply New Time and press ENTER to save your changes.

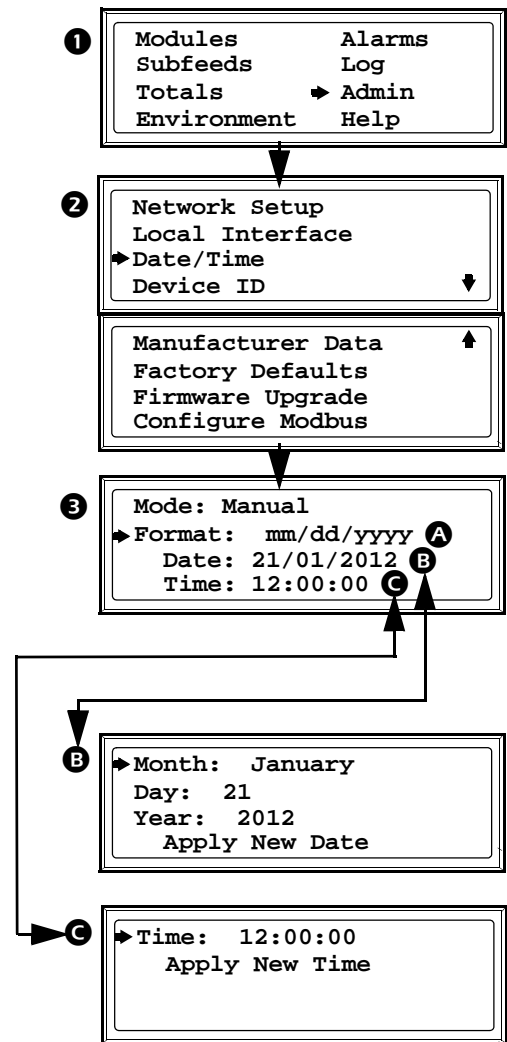

## Configure device ID settings

- 1 Select Admin from the main menu and press ENTER.
- 2 Select Device ID and press ENTER.
- 3 Select the setting you want to change and press ENTER. For Device Name A, Product Contact B, or Product Location C, specify the information for an external device by scrolling through alphabet characters. Press ENTER to select displayed character and proceed to the next character. To end the string, select underline ("\_") and press ENTER.

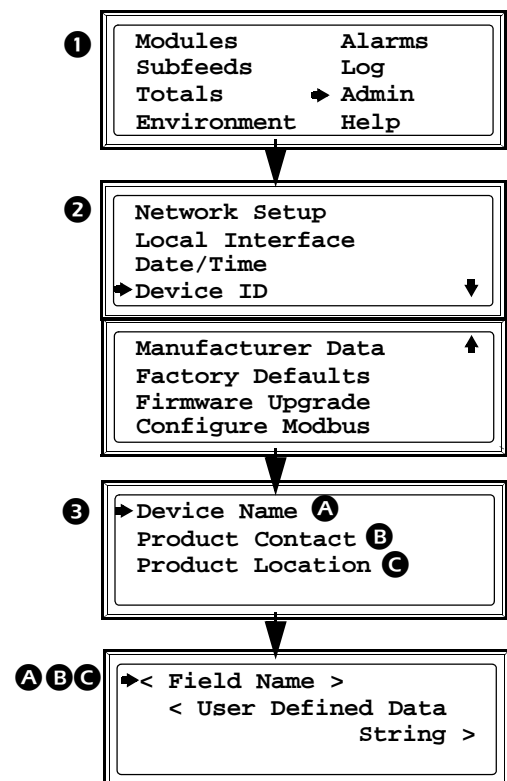

## View system component information

- 1 Select Admin from the main menu and press ENTER.
- 2 Select Manufacturer Data and press ENTER.
- 3 Scroll to the desired System Component and press ENTER. Up to 15 components can be viewed.

## Set the configuration to factory defaults

- 1 Select Admin from the main menu and press the ENTER key.
- 2 Select Factory Defaults and press ENTER.
- 3 Select YES to set to the configuration to factory defaults, or NO to abort the process. Press ENTER.

## Help Submenu

### Use the Help feature

- 1 Select Help from the main menu and press the ENTER key.
- 2 Press the ? key on any line of any screen on the display interface to receive context-sensitive help. Press the DOWN arrow key to view the rest of the help screen. Press the UP arrow key to go back to the previous screen. Press ESC to exit.

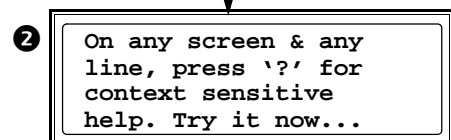
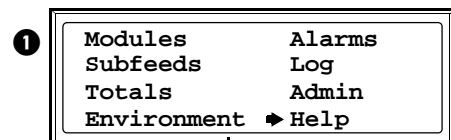
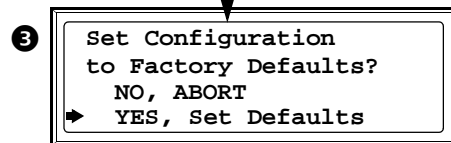
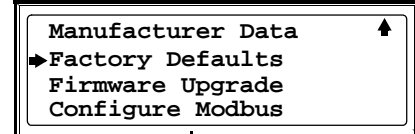
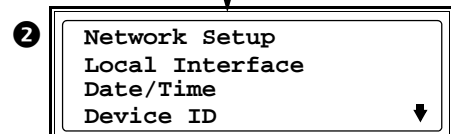
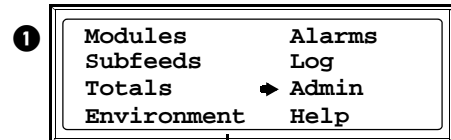
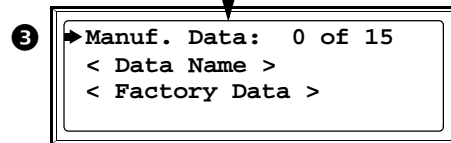
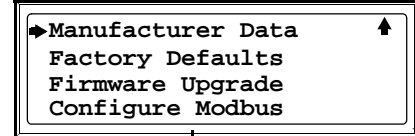
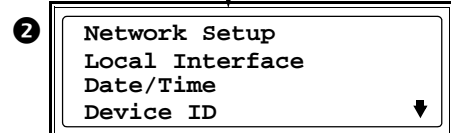
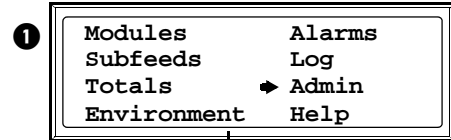



# Modbus Configuration

## Configure Modbus through the Display Interface

### Modbus configuration

**Path: Main > Admin > Configure Modbus**

Use the Configure Modbus menu to set up communications between the equipment and the building management system.

- ❶ Select Admin from the main menu and press the ENTER key.
- ❷ Select Configure Modbus and press ENTER.
- ❸ Choose your selection and press ENTER to set or change:
  - Ⓐ Access: Enable or disable Modbus
  - Ⓑ Target ID: Each Modbus device must have a unique target identification number. Enter a unique number for this unit.
  - Ⓒ Baud Rate: Choose either 9600 bps or 19200 bps.

Press ENTER to save your settings.

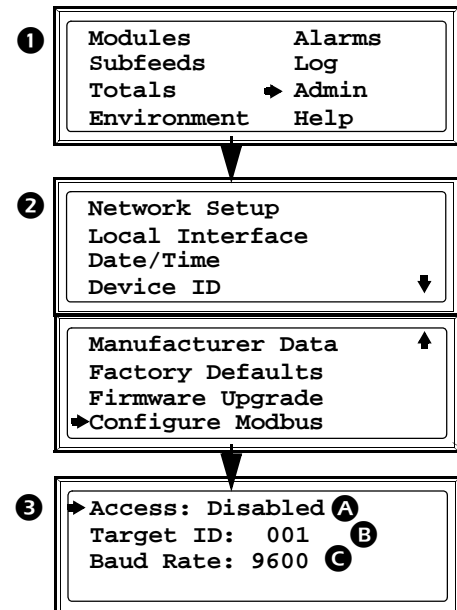

## Modbus cable connection

Modbus communication is available at the console port (RS232 DB-9 connector).

### **NOTICE**

- An RS232 to RS485 converter (not provided) must be used to connect to a building management system.
- All RS232 to RS485 converters tested relied on a power supply that plugs into 110V AC wall receptacle.
- There is a known modbus polarity labeling ambiguity between converters, so if the modbus communication is not successful, try reversing the 2-wire connection.

To communicate RS-232 to the PDU through the console port, the converter must be configured as a DTE device with Send Data Control rather than RTS control (most converters are DCE - some can be ordered as DTE). Some devices support DCE/DTE selection with a switch. Other devices require a zero ohm resistor re-position to configure as a DCE device - see the device datasheet for details. RTS or SD selection is generally accomplished with a jumper.

An appropriate RS-232 cable like the APC 940-0024D is also required.

The console port can be configured to run at either 9600 or 19200 baud. This must match the Building Management System or Modbus network transfer rate.

Most serial converters are capable of either 4-wire or 2-wire modbus connections. The unit is designed to handle 2-wire, half-duplex communication. For a 2-wire, half-duplex connection, jumper connectors should be placed between R+ & T+, and R- & T-. Then the modbus + wire is connected to R+/T+ and the - wire is connected to R-/T-. Some converters offer dip switches to accomplish the jumper connections.

# Network Management Configuration

---

## Overview

**Note:** For complete Network Management Card setup instructions, see the online User Guide at [www.apc.com](http://www.apc.com).

## Initial setup

You must configure the following three TCP/IP settings before the Modular PDU can operate on a network:

- IP address of the Modular PDU
- Subnet mask
- Default gateway  
If a default gateway is unavailable, use the IP address of a computer (that is usually running) located on the same subnet as the NMC. The NMC uses the default gateway to test the network when traffic is light.

**Note:** Do not use the loopback address as the default gateway address for the Network Management Card. You will lose communication with the equipment. Doing so will disable the card and require you to reset TCP/IP settings to their defaults using a local serial login.

**TCP/IP configuration methods.** Use one of the following methods to define the basic TCP/IP settings needed by the Network Management Card.

- APC Device IP Configuration Wizard
- BOOTP or DHCP server
- Networked computer

## Device IP Configuration Wizard

The Wizard runs on Microsoft Windows 2000, Windows 2003, and Windows XP operating systems. The APC Device IP Configuration Wizard configures the IP address, subnet mask, and default gateway of one or more NMCs.

You can use the Wizard in either of the following ways:

- Remotely over your TCP/IP network to discover and configure unconfigured NMCs on the same network segment as the computer running the Wizard.
- Through a direct connection from a serial port of your computer to the PDU to configure or reconfigure it.

**Installation.** Install the Wizard from a downloaded executable file:

1. Go to [www.apc.com/tools/download](http://www.apc.com/tools/download).
2. Download the Device IP Configuration Wizard.
3. Run the executable file in the folder in which it was downloaded.

**Launch the Wizard.** The installation creates a shortcut link in the Start menu to launch the Wizard. Most software firewalls must be temporarily disabled for the Wizard to discover unconfigured NMCs.

## Supported Web browsers

Use Microsoft® Internet Explorer (IE) 7.x and higher (Windows operating systems) or Mozilla Firefox 3.0.6 or higher (all operating systems) to access the NMC through its Web interface. Other commonly available browsers may work but have not been fully tested. The NMC cannot work with a proxy server. Before using a Web browser to access its Web interface, do one of the following:

- Configure the Web browser to disable the use of a proxy server for the NMC.
- Configure the proxy server so that it does not proxy the specific IP address of the NMC.

## Network management features

These applications and utilities work with a Modular PDU that connects to the network through its Network Management Card:

- StruxureWare® —Provide enterprise-level power management and management of APC agents, Modular PDUs, information controllers, and environmental monitors
- PowerNet® Management Information Base (MIB) with a standard MIB browser—Perform SNMP SETs and GETs and to use SNMP traps
- Device IP Configuration Wizard—Configure the basic settings of one or more NMCs over the network
- Security Wizard—Create the components needed for high security for the NMC when using Secure Sockets Layer (SSL) and related protocols and encryption routines

# Log On

Use the DNS name or System IP address of the NMC for the URL address of the Web interface. The default password is **apc** for all three account types. The default user name differs by account type:

- **apc** for an Administrator
- **device** for a Device user
- **readonly** for a Read-Only user

If you are using HTTPS (SSL/TSL) as your access protocol, your logon credentials are compared with information in a server certificate. If the certificate was created with the Security Wizard, and an IP address was specified as the common name in the certificate, you must use an IP address to log on to the NMC. If a DNS name was specified as the common name on the certificate, you must use a DNS name to log on.

## URL address formats

Type the DNS name or IP address of the NMC in the URL address field of the Web browser and press ENTER. When you specify a non-default Web server port in Internet Explorer, you must include `http://` or `https://` in the URL.

### Common browser error messages at log-on.

Error Message	Browser	Cause of the Error
"You are not authorized to view this page" or "Someone is currently logged in..."	Internet Explorer, Firefox	Someone else is logged on.
"This page cannot be displayed."	Internet Explorer	Web access is disabled, or the URL was not correct
"Unable to connect."	Firefox	

# Security

## Access priority for logging on

Only one user at a time can log on to the Modular PDU.

- Local access from a computer with a direct serial connection to the Modular PDU.
- Telnet or Secure SHell (SSH) access to the control console from a remote computer.
- Web access, either directly or through StruxureWare

## User accounts

The three levels of access are protected by user name and password requirements. During authentication, the user's credentials are compared against the Local User Database and/or are validated against a RADIUS server (depending on configuration). If valid, access with appropriate permissions is granted.

- An Administrator can use all the menus in the Web interface. The default user name and password are both **apc**.
- The default user name for the Device User is **device**, and the default password is **apc**. A Device User can access only the menus on the Home, Power Distribution, and Logs tabs in the Web interface.
- A Read-Only User has only Web interface access. The same menus as Device User are visible but no changes can be made. Links to configuration options are visible but disabled. Event and data logs display no button to clear the log. The default user name is **readonly**, and the default password is **apc**.

## Watchdog Features

Watchdog mechanisms detect internal problems. After a restart, a System: Warmstart event is recorded in the event log.

### Network interface watchdog mechanism

Watchdog mechanisms protect the NMC from becoming inaccessible over the network. If it does not receive any network traffic for 9.5 minutes, it assumes there is a problem with its interface and restarts.

### Resetting the network timer

To ensure the NMC does not restart if the network is quiet for 9.5 minutes, it attempts to contact the default gateway every 4.5 minutes. The gateway response resets the 9.5-minute timer. If your application does not require or have a gateway, specify the IP address of a computer that is running on the network most of the time and is on the same subnet. The network traffic of that computer will restart the 9.5-minute timer frequently enough to prevent the NMC from restarting.

## Recover from a Lost Password

1. At the local computer, select a serial port, and disable any service that uses it.
2. Connect the provided serial cable to the computer and the port on the PDU.
3. Run a terminal program (such as HyperTerminal<sup>®</sup>) and configure the port for 9600 bps, 8 data bits, no parity, 1 stop bit, and no flow control.
4. Press `ENTER`, repeatedly if necessary, to display the User Name prompt. If you are unable to display the User Name prompt, verify the following:
  - The serial port is not in use by another application.
  - The terminal settings are correct as specified in step 3.
  - The correct cable is being used.
5. Press the Reset button on the back of the unit. The Status LED will flash. Press the Reset button a second time while the LED is flashing to reset the user name and password to the default.
6. Press `ENTER` as many times as necessary until the User Name prompt displays, then use the default, **apc**, user name and password. (If you take longer than 30 seconds to log on after the User Name prompt is displayed, you must repeat step 5 and log on again.)
7. Select System, then User Manager.
8. Select Administrator, and change the User Name and Password settings from the default **apc**.
9. Press `CTRL+C` and log off. Return the local computer to its original configuration.

# Maintenance

---

## Parts Replacement

### Determine if you need a replacement part

To determine if you need a replacement part, contact Schneider Electric Customer Support online at [www.schneider-electric.com](http://www.schneider-electric.com) and follow the procedure below so that a representative can assist you promptly:

1. The display interface may show additional screens if module replacement is necessary. Press any key to scroll through these lists, record the information, and provide it to the representative.
2. Write down the serial number of the unit so that you will have it easily accessible when you contact Customer Support.
3. If possible, call Customer Support from a telephone that is within reach of the unit so that you can gather and report additional information to the representative.
4. Be prepared to provide a detailed description of the problem. A representative will attempt to help you over the telephone, if possible, or will assign a Return Material Authorization (RMA) number to you. If a module is returned, this RMA number must be clearly printed on the outside of the package.
5. If the unit is within the warranty period, repairs or replacements will be performed free of charge. If it is not within the warranty period, there will be a charge.
6. If the unit is covered by a service contract, have the contract available to provide information to the representative.

### Return parts

Contact Customer Support to obtain an (Returned Materials Authorization (RMA) number.

To return a module, pack the module in the original shipping materials, and return it by insured, prepaid carrier. The Customer Support representative will provide the destination address. If you no longer have the original shipping materials, ask the representative about obtaining a new set. Pack the module properly to avoid damage in transit. Never use Styrofoam beads or other loose packaging materials when shipping a module, as the module may settle in transit and become damaged. Enclose a letter in the package with your name, RMA number, address, a copy of the sales receipt, description of the problem, a phone number, and a check as payment (if necessary).

**Note:** Damages sustained in transit are not covered under warranty.



# Power Distribution Modules

**⚠ ⚠ DANGER**

**HAZARD OF ELECTRIC SHOCK, EXPLOSION, OR ARC FLASH**

- Electrical equipment must be installed, operated, serviced, and maintained only by qualified personnel.
- To remove a Power Distribution Module:
  - Turn off all power supplying the equipment and perform appropriate lockout/tagout procedures before installing or removing the Power Distribution Module.
  - OR
  - If a Symmetra PX UPS is providing power to the Modular PDU, place the UPS into battery operation (to reduce fault current) before removing the Power Distribution Module.

**Failure to follow these instructions will result in death or serious injury.**

**NOTICE**

- Install only Schneider Electric PDMs with matching output voltage.
- Install PDMs starting from the bottom of the panel to avoid cable congestion.
- Save filler plates for future re-use. If a module is removed, a filler plate must be installed to cover the open space.

Factory installed filler plates and slot locks cover each module position.

Before putting the unit into service, the backplane of each module position must be covered with a filler plate or by installing a Power Distribution Module (PDM). All positions must be secured with a slot lock.

## Component identification

- 1 Slot lock key
- 2 Slots (hold modules in place)
- 3 Backplane
- 4 Filler plate
- 5 Module slot lock
- 6 Power distribution module

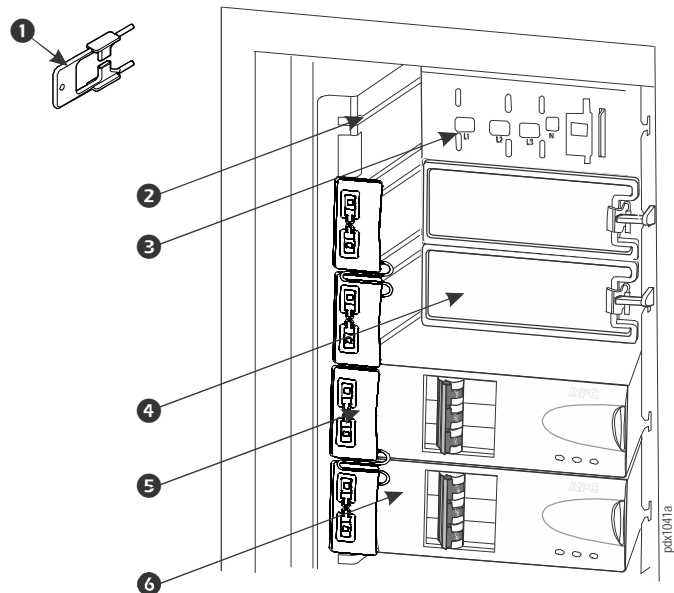

**Note:** Two slot locks are attached together as a pair.  
The illustration shows the top lock removed from its slot but still attached to the installed lock below it.

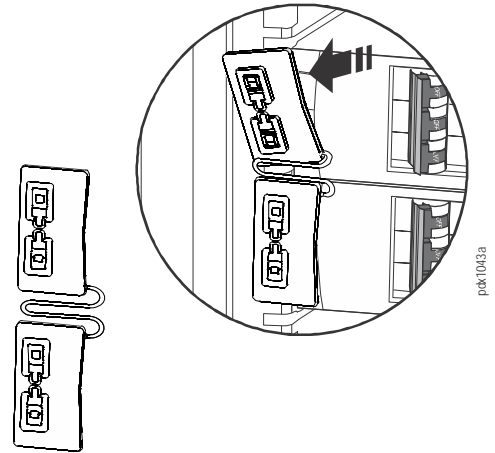

### Module circuit breaker operation

**Note:** The circuit breaker handle will pull all the breakers to the OFF position but can be flipped up to access the individual breakers separately.

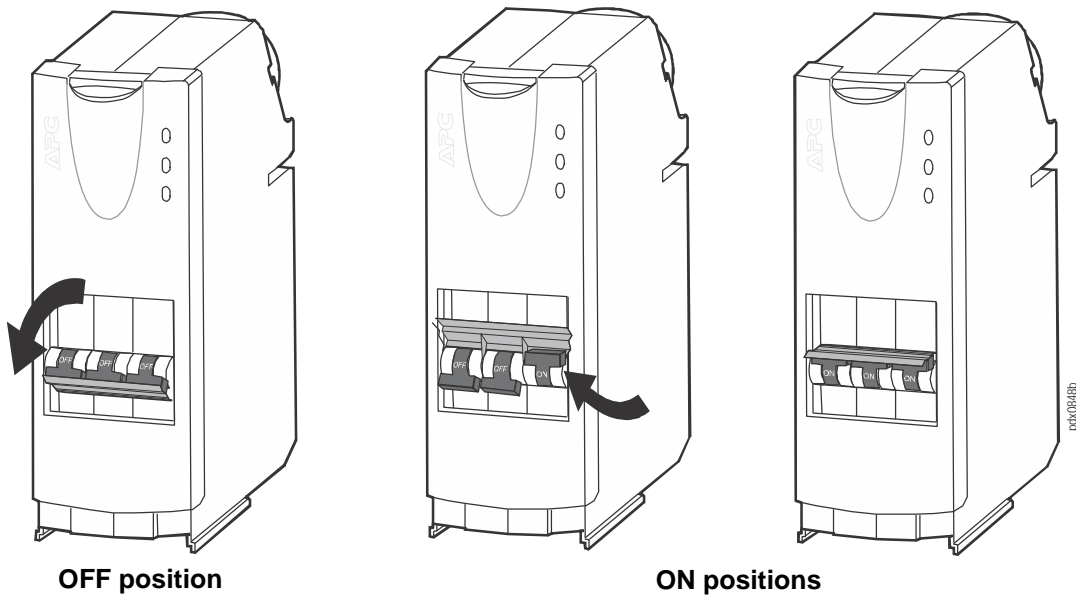

## Installation

Open the front door of the unit.

**⚠ ⚠ DANGER**

**HAZARD OF ELECTRIC SHOCK, EXPLOSION, OR ARC FLASH**

- Electrical equipment must be installed, operated, serviced, and maintained only by qualified personnel.
- To remove a Power Distribution Module:
  - Turn off all power supplying the equipment and perform appropriate lockout/tagout procedures before installing or removing the Power Distribution Module.
  - OR
  - If a Symmetra PX UPS is providing power to the Modular PDU, place the UPS into battery operation (to reduce fault current) before removing the Power Distribution Module.

**Failure to follow these instructions will result in death or serious injury.**

### Remove the slot lock .

Use the key (provided) to remove the slot lock.

- ❶ Insert the key in the slot lock as shown in the illustration at left.
- ❷ Squeeze the sides of the key inward to grasp the slot lock firmly.
- ❸ Pull the slot lock key out, while squeezing, to extract the lock from the slot.

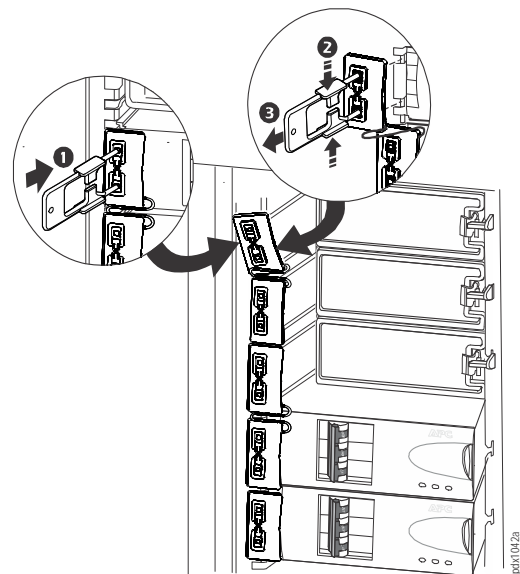

## Remove the filler plates.

- 1 Press down on the filler plate clip to release its locking mechanism.
- 2 Pull the filler plate directly toward you and along the slot until it is free.

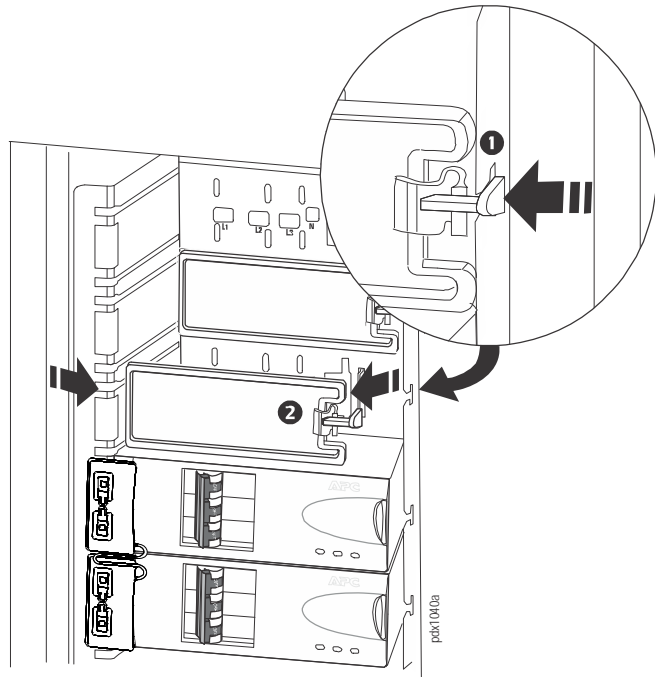

## Install a module

- 1 Make sure all breakers on the PDM being installed are in the OFF (open) position.

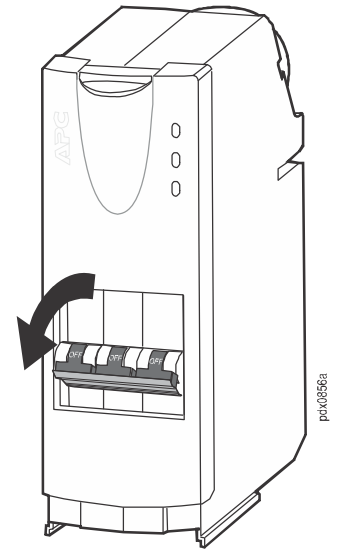

- 2 Press the red button to release the latch on the PDM.
- 3 Pull open the latch.

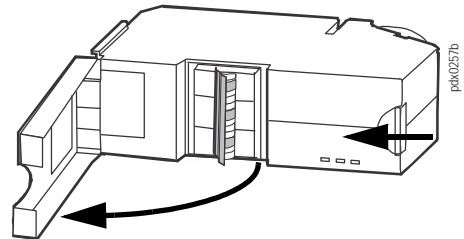

- Slide the PDM into the panel using the top and bottom guide tracks (slots) for that position. Make sure you slide the PDM all the way into its position. Close the latch to tighten the electrical contacts in the PDM against the bus bar.

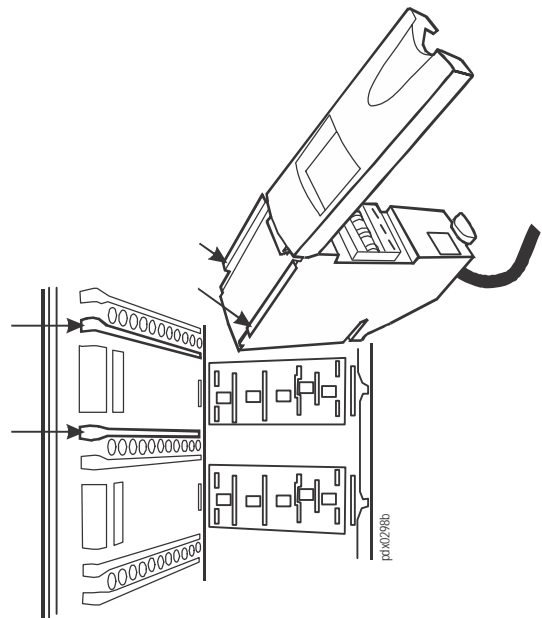

- Feed cable from the PDM through the slot in the roof.

Leave a minimum of 7 inches (178 mm) of slack in the cable behind the module. The slack is useful in case the module is ever removed or replaced. 10 to 20 inches (254 to 508 mm) is recommended but space restrictions in the PDU and cable diameter size will cause the amount of slack to necessarily vary.

**Note:** When installing PDMs near the top of the panel, feed the cable first, pulling up the slack, and then secure the module to the bus bar to avoid cable congestion between the panel and the slot.

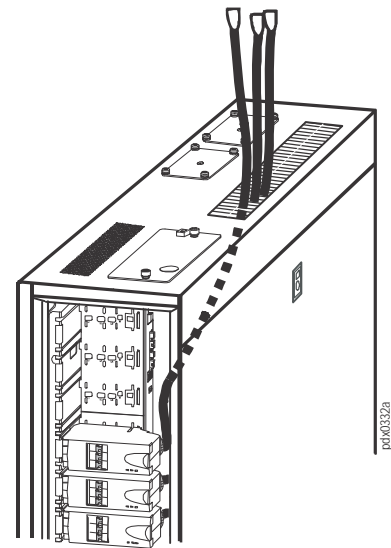

- 6 Use plastic ties to secure loose cable(s) to the enclosure (only in Vertical Rack Distribution Panels).

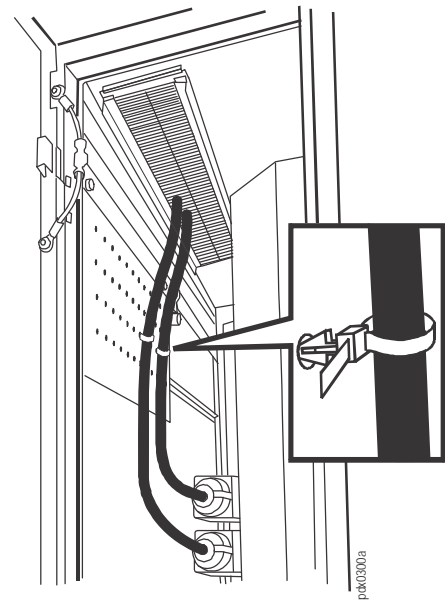

- 7 Set the required breakers on the newly installed PDM to the ON (closed) position.

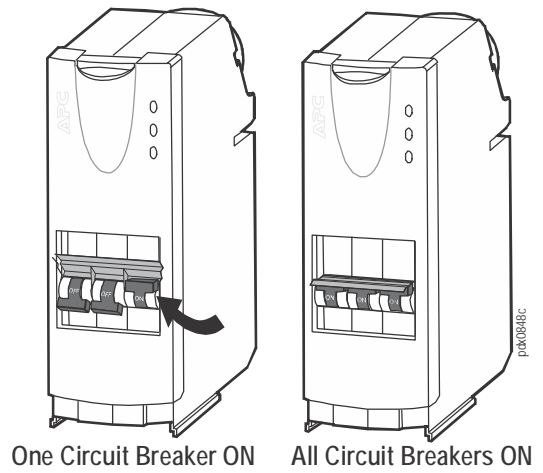

## Remove the filler plates.

Install filler plates to properly cover 3-pole panel positions not occupied by a PDM.

- 1 Position the filler plate in front of an open PDM location and insert the bottom tab of the filler plate into the slot.
- 2 Snap the filler plate into position. Check that the latch is secure.

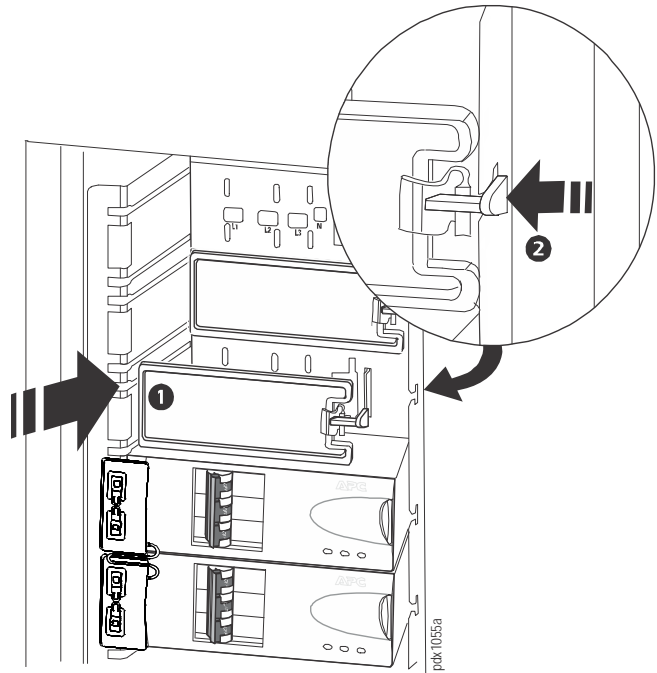

## Install a slot lock.

**Note:** A slot lock must be installed in each module space whether filled by a module or filler plate.

Press the slot lock into the slots as shown in the illustration.

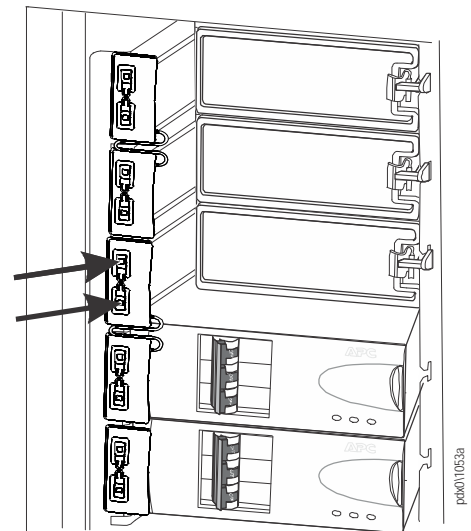

**Note:** Upon completion of PDM installation, close the door to the PDU.

## Connect Module cables.

Connect the PDM cable to the appropriate Rack PDU or other equipment.

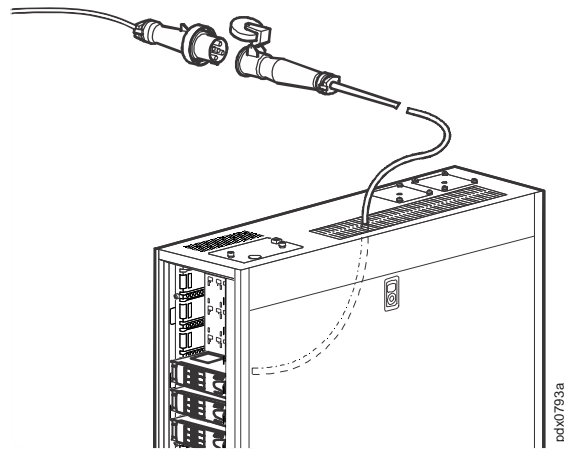

**Note:** Power can be restored to the PDU following connection of the PDM cables to the load.

## Remove a PDM

**⚠ ⚠ DANGER**

**HAZARD OF ELECTRIC SHOCK, EXPLOSION, OR ARC FLASH**

- Electrical equipment must be installed, operated, serviced, and maintained only by qualified personnel.
- To remove a Power Distribution Module:
  - Turn off all power supplying the equipment and perform appropriate lockout/tagout procedures before installing or removing the Power Distribution Module.
  - OR
  - If a Symmetra PX or Symmetra MW UPS is providing power to the Modular PDU, place the UPS into battery operation (to reduce fault current) before removing the Power Distribution Module.

**Failure to follow these instructions will result in death or serious injury.**

Reverse the module installation procedure to remove a PDM.



# Troubleshooting

## LEDs on Power Distribution Modules

There are three LEDs on each power distribution module. The LEDs indicate the following conditions:

- Red: Critical alarm
- Yellow: Warning alarm
- Green: No alarm
- Flashing green: The module is being identified by the system. The flashing should only last a few seconds. It will stop once the module has been identified.

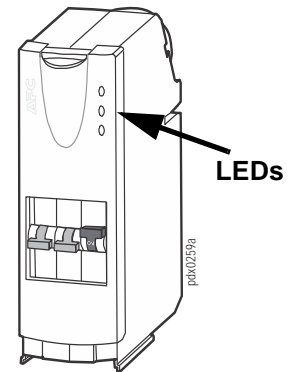

## Status and Alarm Messages

The PDU may display any of the following status and alarm messages. The messages are listed in alphabetical order, along with recommended corrective actions to help you troubleshoot problems.

Display Message	Meaning	Corrective Action
High Module Current	The module current exceeded the high threshold.	Evaluate the threshold setting. If necessary, adjust it to properly accommodate your situation.
High Subfeed Current	The subfeed current exceeded the high threshold.	Evaluate the threshold setting. If necessary, adjust it to properly accommodate your situation.
High Total Output Current	The total output current exceeded the high threshold.	Evaluate the threshold setting. If necessary, adjust it to properly accommodate your situation.
High Output Voltage	The output voltage exceeded the high threshold.	Evaluate the threshold setting. If necessary, adjust it to properly accommodate your situation.
Low Module Current	The module current dropped below the low threshold.	Evaluate the threshold setting. If necessary, adjust it to properly accommodate your situation.
Low Subfeed Current	The subfeed current dropped below the low threshold.	Evaluate the threshold setting. If necessary, adjust it to properly accommodate your situation.
Low Total Output Current	The total output current dropped below the low threshold.	Evaluate the threshold setting. If necessary, adjust it to properly accommodate your situation.
Low Output Voltage	The output voltage dropped below the low threshold.	Evaluate the threshold setting. If necessary, adjust it to properly accommodate your situation.
Maximum Module Current	The module current exceeded the maximum threshold.	Evaluate the threshold setting. If necessary, adjust it to properly accommodate your situation.

Maximum Subfeed Current	The subfeed current exceeded the maximum threshold.	Evaluate the threshold setting. If necessary, adjust it to properly accommodate your situation.
Max Total Output Current	The total output current exceeded the maximum threshold.	Evaluate the threshold setting. If necessary, adjust it to properly accommodate your situation.
Max Output Voltage	The output voltage exceeded the maximum threshold.	Evaluate the threshold setting. If necessary, adjust it to properly accommodate your situation.
Minimum Module Current	The module current dropped below the minimum threshold.	Evaluate the threshold setting. If necessary, adjust it to properly accommodate your situation.
Minimum Subfeed Current	The subfeed current dropped below the minimum threshold.	Evaluate the threshold setting. If necessary, adjust it to properly accommodate your situation.
Min Total Output Current	The total output current dropped below the minimum threshold.	Evaluate the threshold setting. If necessary, adjust it to properly accommodate your situation.
Min Output Voltage	The output voltage dropped below the minimum threshold.	Evaluate the threshold setting. If necessary, adjust it to properly accommodate your situation.
Modular Distribution Communication	Communication has been lost with the modular distribution breakers.	Check the communication cables to ensure they are properly connected. If properly connected, contact APC Customer Support for resolution.
Module Breaker Open	A modular circuit breaker is open.	Check the modular circuit breakers to see if one has been overloaded. Replace, if necessary.
Output Frequency	The output frequency is exceeding the frequency deviation threshold.	Evaluate the threshold setting and the power quality. If necessary, adjust the threshold setting to properly accommodate your situation. <b>Note:</b> Some backup generators do not tightly regulate their output during normal operation and can trigger this alarm.
Subfeed Breaker Open	A subfeed circuit breaker is open.	Check the subfeed circuit breakers to see if one has been overloaded.
Transformer Overheating	The transformer is too hot.	Ensure the loads are balanced evenly on each phase. If necessary, reduce the size of the load.



# Worldwide Customer Support

Customer support is available [www.schneider-electric.com](http://www.schneider-electric.com).

© 2015 Schneider Electric. APC, the APC logo, StruxureWare, Symmetra, and InfraStruxure are owned by Schneider Electric Industries S.A.S. All other trademarks are property of their respective owners.