

Modicon Quantum 140 NRP 312 00/01 Fiber Converter Modules User Guide

(Original Document)

12/2018

The information provided in this documentation contains general descriptions and/or technical characteristics of the performance of the products contained herein. This documentation is not intended as a substitute for and is not to be used for determining suitability or reliability of these products for specific user applications. It is the duty of any such user or integrator to perform the appropriate and complete risk analysis, evaluation and testing of the products with respect to the relevant specific application or use thereof. Neither Schneider Electric nor any of its affiliates or subsidiaries shall be responsible or liable for misuse of the information contained herein. If you have any suggestions for improvements or amendments or have found errors in this publication, please notify us.

You agree not to reproduce, other than for your own personal, noncommercial use, all or part of this document on any medium whatsoever without permission of Schneider Electric, given in writing. You also agree not to establish any hypertext links to this document or its content. Schneider Electric does not grant any right or license for the personal and noncommercial use of the document or its content, except for a non-exclusive license to consult it on an "as is" basis, at your own risk. All other rights are reserved.

All pertinent state, regional, and local safety regulations must be observed when installing and using this product. For reasons of safety and to help ensure compliance with documented system data, only the manufacturer should perform repairs to components.

When devices are used for applications with technical safety requirements, the relevant instructions must be followed.

Failure to use Schneider Electric software or approved software with our hardware products may result in injury, harm, or improper operating results.

Failure to observe this information can result in injury or equipment damage.

© 2018 Schneider Electric. All rights reserved.

Table of Contents



	Safety Information	5
	About the Book	7
Chapter 1	Introducing the 140 NRP 312 00/01 Fiber Converter Module	9
	140 NRP 312 00/01 Introduction	10
	140 NRP 312 00/01 Description	11
	140 NRP 312 00/01 LED Indicators	13
	140 NRP 312 00/01 Topologies	14
	140 NRP 312 00/01 Specifications	19
	Index	21

Safety Information



Important Information

NOTICE

Read these instructions carefully, and look at the equipment to become familiar with the device before trying to install, operate, service, or maintain it. The following special messages may appear throughout this documentation or on the equipment to warn of potential hazards or to call attention to information that clarifies or simplifies a procedure.



The addition of this symbol to a “Danger” or “Warning” safety label indicates that an electrical hazard exists which will result in personal injury if the instructions are not followed.



This is the safety alert symbol. It is used to alert you to potential personal injury hazards. Obey all safety messages that follow this symbol to avoid possible injury or death.

DANGER

DANGER indicates a hazardous situation which, if not avoided, **will result in** death or serious injury.

WARNING

WARNING indicates a hazardous situation which, if not avoided, **could result in** death or serious injury.

CAUTION

CAUTION indicates a hazardous situation which, if not avoided, **could result in** minor or moderate injury.

NOTICE

NOTICE is used to address practices not related to physical injury.

PLEASE NOTE

Electrical equipment should be installed, operated, serviced, and maintained only by qualified personnel. No responsibility is assumed by Schneider Electric for any consequences arising out of the use of this material.

A qualified person is one who has skills and knowledge related to the construction and operation of electrical equipment and its installation, and has received safety training to recognize and avoid the hazards involved.

About the Book



At a Glance

Document Scope

This document is the reference guide for the Quantum 140 NRP 312 00/01 fiber converter modules.

Validity Note

This documentation is valid for EcoStruxure™ Control Expert 14.0 or later.

Related Documents

Title of Documentation	Reference Number
Modicon Remote I/O Cable System Planning and Installation Guide	35014629 (English), 35014630 (French), 35014632 (German), 35014633 (Spanish)
Modicon Quantum Hot Standby System User Manual	35010533 (English), 35010534 (French), 35010535 (German), 35010536 (Spanish), 35013993 (Italian), 35012188 (Chinese)
Quantum With EcoStruxure™ Control Expert Experts and Communication Reference Manual	35010574 (English), 3501575 (French), 3501576 (German), 3501577 (Spanish), 3504012 (Italian), 35012187 (Chinese)

Title of Documentation	Reference Number
Quantum With EcoStruxure™ Control Expert Hardware Reference Manual	35010529 (English), 35010530 (French), 35010531 (German), 35010532 (Spanish), 35013975 (Italian), 35012184 (Chinese)
Modicon Fiber Optic Repeater's User Guide	EIO0000000872 (English), EIO0000000952 (French), EIO0000000953 (German), EIO0000000955 (Spanish), EIO0000000954 (Italian), EIO0000000956 (Chinese)

You can download these technical publications and other technical information from our website at <https://www.schneider-electric.com/en/download>

Product Related Information

 WARNING
<p>UNINTENDED EQUIPMENT OPERATION</p>
<p>The application of this product requires expertise in the design and programming of control systems. Only persons with such expertise should be allowed to program, install, alter, and apply this product.</p>
<p>Follow all local and national safety codes and standards.</p>
<p>Failure to follow these instructions can result in death, serious injury, or equipment damage.</p>

Chapter 1

Introducing the 140 NRP 312 00/01 Fiber Converter Module

Introduction

This chapter describes the 140 NRP 312 00/01 fiber converter module and how to use it within a Quantum EIO system.

What Is in This Chapter?

This chapter contains the following topics:

Topic	Page
140 NRP 312 00/01 Introduction	10
140 NRP 312 00/01 Description	11
140 NRP 312 00/01 LED Indicators	13
140 NRP 312 00/01 Topologies	14
140 NRP 312 00/01 Specifications	19

140 NRP 312 00/01 Introduction

Using 140 NRP 312 00/01 Fiber Converter Modules

WARNING

UNINTENDED EQUIPMENT OPERATION

Do not connect a 140 NRP 312 01 single-mode fiber converter module to a 140 NRP 312 00 multi-mode fiber converter module.

Failure to follow these instructions can result in death, serious injury, or equipment damage.

140 NRP 312 00/01 fiber converter modules are an alternative method to using a dual-ring switch (DRS) to provide fiber optic communications in a Quantum EIO system.

You can install 140 NRP 312 00/01 modules on Quantum local and RIO drops to:

- extend the total length of the Quantum EIO network (RIO drops in separate areas of a factory that are more than 100 m apart)
- improve noise immunity
- resolve possible grounding issues when using different grounding methods is required between 2 buildings

You can connect a 140 NRP 312 00/01 module to any 100Mbps-based Ethernet module on a Quantum rack to extend the transmission distance. Examples:

- You can connect a 140 NRP 312 00/01 module to a 140 CRP 312 00 RIO head module or a 140 CRA 312 0• RIO adapter module in a Quantum EIO system.
- You can connect a 140 NRP 312 00/01 module to a 140 NOC 780 00 DIO head module to manage DIO devices.

There are 2 models of fiber converter modules, each supporting one type of fiber cable:

- 140 NRP 312 00 supports multi-mode fiber cable.
- 140 NRP 312 01 supports single-mode fiber cable.

For details on other fiber converter modules and how they operate within Quantum and M340 networks, refer to the *140 NRP 954 00/01C Fiber Optic Repeater Modules User Guide* and the *BMX NRP 0200/01 Fiber Converter Module User Guide*.

140 NRP 312 00/01 Description

Introduction

140 NRP 312 00/01 fiber converter modules have 2 copper ports and 2 fiber ports. The fiber ports, in both multi-mode and single-mode modules, use LC-type connectors. One fiber port is used as the transmitter signal (Tx), and the other fiber port is used as the receiver signal (Rx).

There are 2 models of fiber converter modules, each supporting one type of fiber cable:

- 140 NRP 312 00 supports multi-mode fiber cable.
- 140 NRP 312 01 supports single-mode fiber cable.

140 NRP 312 00/01 Description

The following figure shows the 140 NRP 312 00/01 fiber converter module:

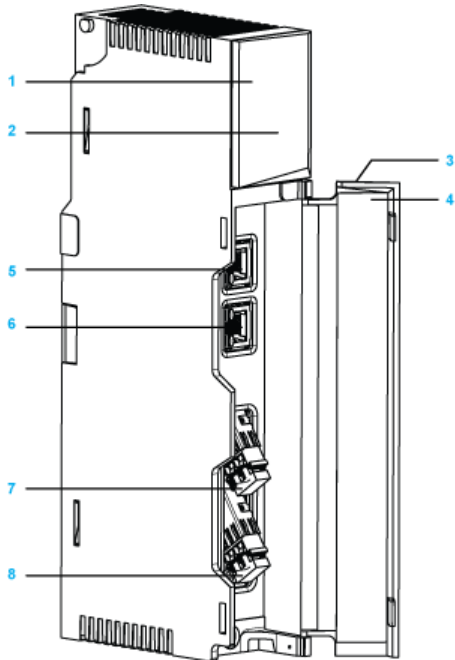

- 1 model number, description code, color code
- 2 LEDs
- 3 removable door
- 4 customer identification label (Fold label and place it inside door.)
- 5 Ethernet port 1
- 6 Ethernet port 2
- 7 fiber port 1
- 8 fiber port 2

NOTE:

There are 2 separate pairs:

- pair 1: Ethernet port 1 + fiber port 1
- pair 2: Ethernet port 2 + fiber port 2

140 NRP 312 00/01 LED Indicators

LED Description

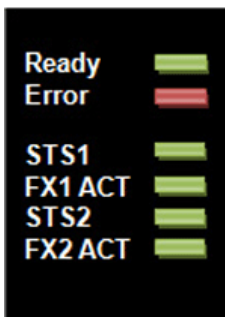

The following table describes the status of the LEDs:

LED	Color	State	Indication
Ready	Green	off	The module is not powered.
		on	The module is powered.
Error	Red	off	No error has been detected.
		on	An error has been detected.
STS1 / STS2	Green	flashing ¹	No link is detected on the fiber port.
		on	A link is detected on the fiber port.
FX1 ACT / FX2 ACT	Red	flashing ¹	Communication activity is detected on the fiber port.

¹ The LED flashes in a pattern of on for 200 ms and off for 200 ms.

140 NRP 312 00/01 Topologies

Introduction

 WARNING
--

UNINTENDED EQUIPMENT OPERATION

Do not connect a 140 NRP 312 01 single-mode fiber converter module to a 140 NRP 312 00 multi-mode fiber converter module.

Failure to follow these instructions can result in death, serious injury, or equipment damage.

Using 140 NRP 312 00/01 fiber converter modules in a Quantum EIO network allows you to transition from copper to fiber cable then back again to copper cable.

140 NRP 312 00/01 modules can be used to extend the distance between the local rack and an RIO drop, between 2 RIO drops, or between primary and standby racks in a Hot Standby system.

Installing Fiber Converter Modules to Extend Distance Between the Local Rack and an RIO Drop

The following figure shows a Quantum EIO network using 140 NRP 312 00/01 fiber converter modules to extend the distance between the local rack and RIO drops beyond 100 m.

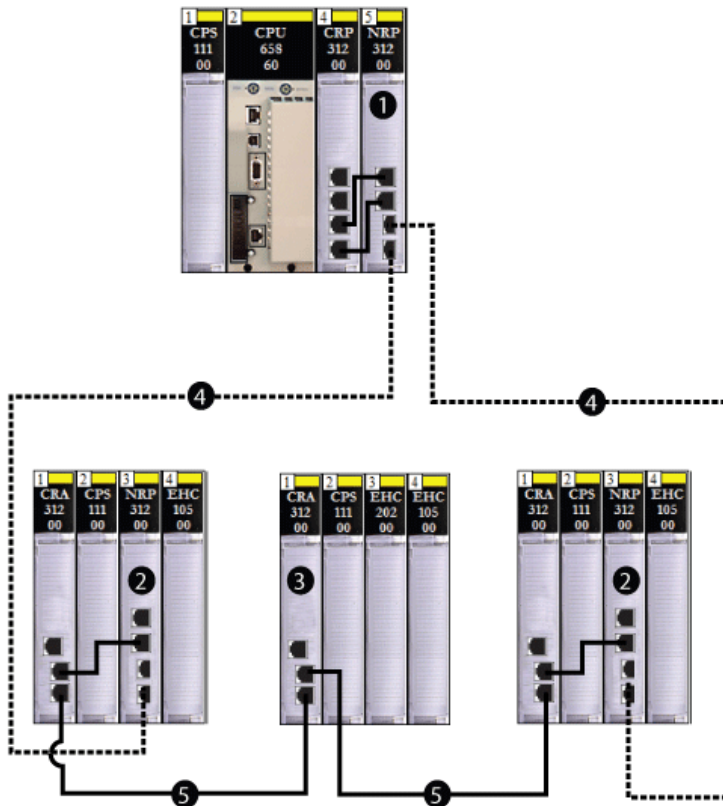

- 1 140 NRP 312 00/01 fiber converter module interlinked with the 140 CRP 312 00 RIO head module on the local rack
- 2 RIO drop **with** a 140 NRP 312 00/01 fiber converter module interlinked with a 140 CRA 312 00 RIO adapter for fiber cable connection
- 3 RIO drop **without** a 140 NRP 312 00/01 fiber converter module for copper cable connection
- 4 fiber cable on the main ring used for distances greater than 100 m
- 5 copper cable on the main ring used for distances less than 100 m

Installing Fiber Converter Modules to Extend Distance Between RIO Drops

The following figure shows a Quantum EIO network using 140 NRP 312 00/01 fiber converter modules to extend the distance between the local rack and RIO drops beyond 100 m.

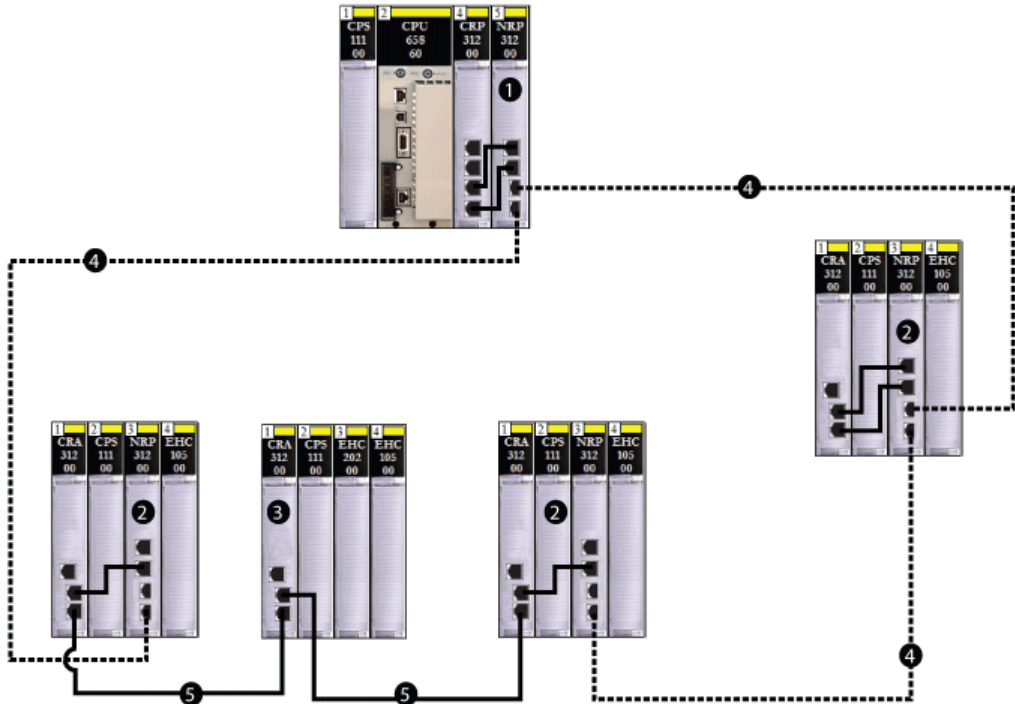

- 1 140 NRP 312 00/01 fiber converter module interlinked with the 140 CRP 312 00 RIO head module on the local rack
- 2 RIO drop **with** a 140 NRP 312 00/01 fiber converter module interlinked with a 140 CRA 312 +0 RIO adapter for fiber cable connection
- 3 RIO drop **without** a 140 NRP 312 00/01 fiber converter module for copper cable connection
- 4 fiber cable on the main ring used for distances greater than 100 m
- 5 copper cable on the main ring used for distances less than 100 m

Installing Fiber Converter Modules to Extend Distance Between DIO Devices

The following figure shows a Quantum EIO network using 140 NRP 312 00/01 fiber converter modules to extend the distance between DIO devices beyond 100 m.

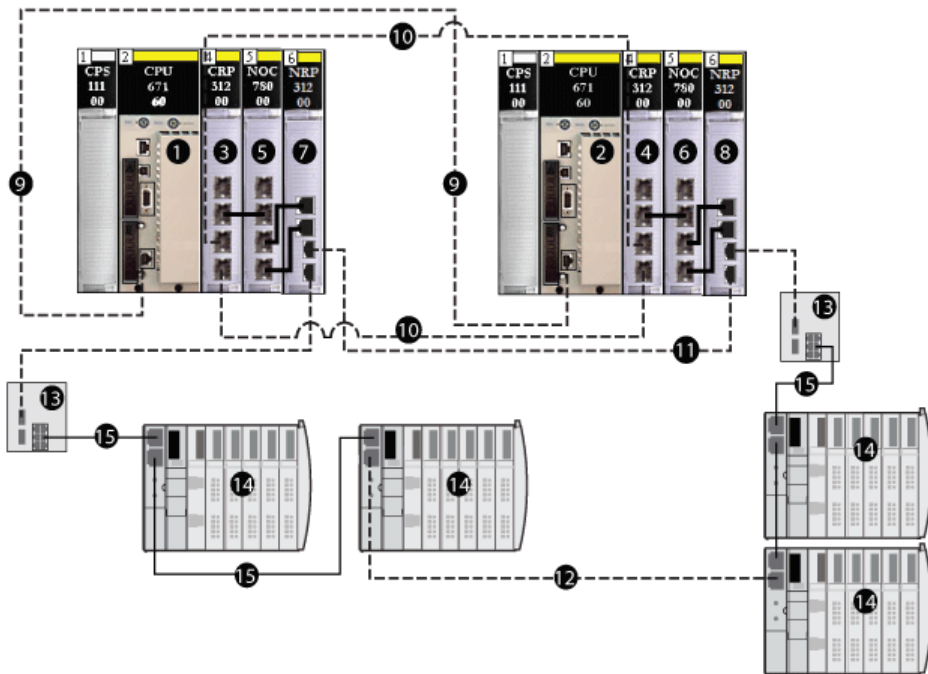

- 1 Quantum CPU on the primary local rack
- 2 Quantum CPU on the standby local rack
- 3 140 CRP 312 00 RIO head module on the primary local rack
- 4 140 CRP 312 00 RIO head module on the standby local rack
- 5 140 NOC 750 00 DIO head module interlinked with the 140 CRP 312 00 module (3) and the 140 NRP 312 00/01 fiber converter module (7) on the primary local rack
- 6 140 NOC 750 00 DIO head module interlinked with the 140 CRP 312 00 module (4) and the 140 NRP 312 00/01 fiber converter module (8) on the standby local rack
- 7 140 NRP 312 00/01 fiber converter module interlinked with the 140 NOC 750 00 DIO head module (5) on the primary local rack
- 8 140 NRP 312 00/01 fiber converter module interlinked with the 140 NOC 750 00 DIO head module (6) on the standby local rack
- 9 fiber sync-link connecting the primary and standby CPUs (1 & 2)
- 10 fiber sync-link connecting the primary and standby 140 CRP 312 00 modules (3 & 4)
- 11 fiber sync-link connecting the primary and standby 140 NRP 312 00/01 modules (7 & 8)
- 12 fiber cable on the main ring used for distances greater than 100 m
- 13 dual-ring switch (DRS) used to connect DIO devices (14) to the main ring
- 14 DIO device
- 15 copper cable on the main ring used for distances less than 100 m

Installing Fiber Converter Modules in a Hot Standby System

The following figure shows a Quantum EIO Hot Standby network using 140 NRP 312 00/01 fiber converter modules to extend the distance between the local rack and RIO drops beyond 100 m. The use of fiber converter modules are useful to help avoid noise, attenuation, and/or distant grounding when the distance between the primary and standby PLCs exceeds 100 m.

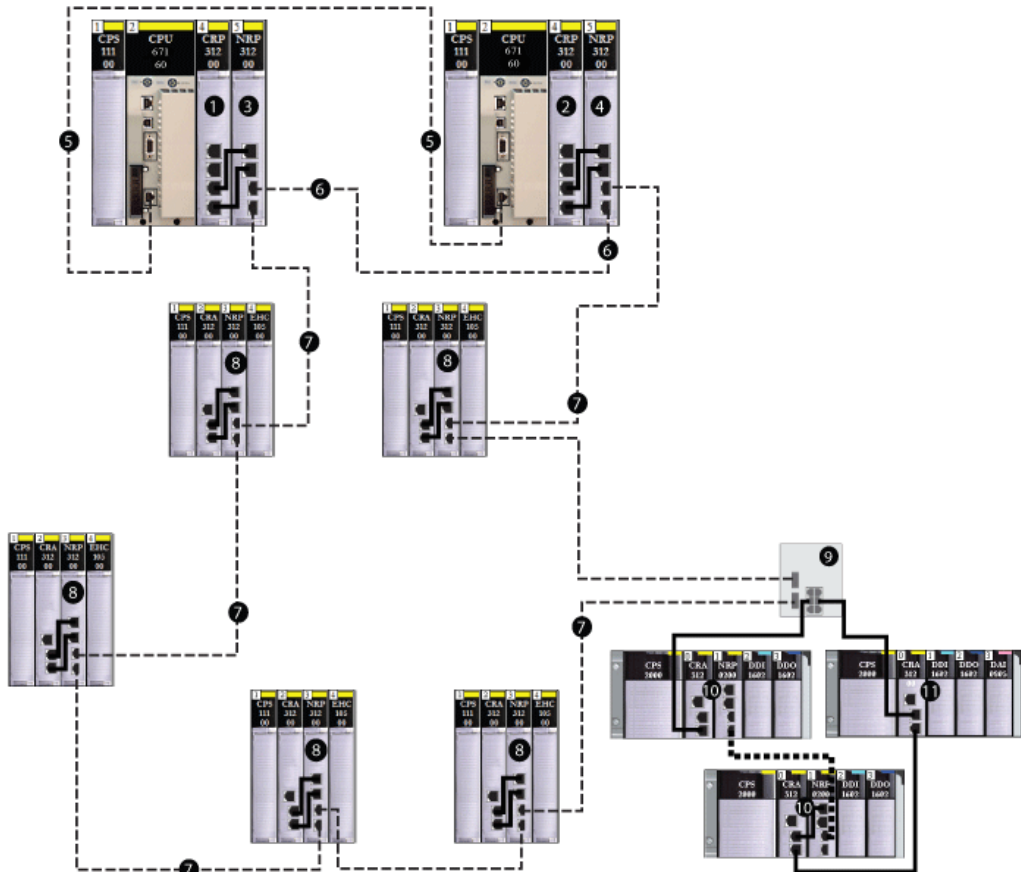

- 1 Quantum CPU on the primary local rack
- 2 Quantum CPU on the standby local rack
- 3 140 NRP 312 0• fiber converter module interlinked with the 140 CRP 312 00 RIO head module on the primary local rack
- 4 140 NRP 312 0• fiber converter module interlinked with the 140 CRP 312 00 RIO head module on the standby local rack
- 5 fiber sync-link connecting the primary and standby CPUs
- 6 fiber sync-link connecting the primary and standby 140 NRP 312 0• fiber converter modules
- 7 fiber main ring
- 8 Quantum RIO drop
- 9 X80 RIO drop

140 NRP 312 00/01 Specifications

General Specifications

WARNING

UNINTENDED EQUIPMENT OPERATION

Do not exceed any of the rated values specified in the following tables.

Failure to follow these instructions can result in death, serious injury, or equipment damage.

Item	140 NRP 312 00	140 NRP 312 01
power consumption in backplane (5VDC)	Typical: 760 mA Maximum: 1000 mA	Typical: 760 mA Maximum: 1000 mA
wavelength	1310 nm	1310 nm
fiber	50/125 μm 62.5/125 μm	9/125 μm
expansion	0-2 km	0-15 km

Optical Transmitter Specifications

Item	140 NRP 312 00	140 NRP 312 01
optical power	-23.5...-14 dBm with 50/125 μm fiber cable -20...-15 dBm with 62.5/125 μm fiber cable	-15...-8 dBm with 9/125 μm fiber cable
rise / fall time	3 nsec or better	2.5 nsec or better
transmitter disable off power	-45 dBm	-45 dBm

Optical Receiver Specifications

Item	140 NRP 312 00	140 NRP 312 01
receiver sensitivity	-30 dBm	-28 dBm
loss of signal deassert	-45 dBm	-45 dBm

Mechanical Specifications

weight	1 kg (2 lb) max
dimensions (h x d x w)	250 x 103.85 x 40.34 mm (9.84 x 4.09 x 1.59 in)
material (enclosures and bezels)	polycarbonates
space requirements	1 rack slot

Electrical Specifications

RFI immunity (IEC 1000-4-3)	80...1000 MHz, 10 V/m
surge (IEC 1000-4-5)	1 kV shield to ground
electrostatic discharge (IEC 1000-4-2)	8 kV air / 4 kV contact
dielectric strength	field to bus: 1400 Vdc channel to channel: 500 Vdc

Operating Conditions

temperature	0...60 °C (32...140 °F)
humidity	90...95% RH non-condensing at 6 °C
chemical interactions	Enclosures and terminal strips are made of polycarbonates. This material can be damaged by strong alkalis and various hydrocarbons, esters, halogens and ketones in combination with heat. Common products containing these include detergents, PVC products, petroleum products, pesticides, disinfectants, paint removers, and spray paints.
altitude	2,000 m. When the altitude exceeds this, reduce the 60 °C maximum operating temperature by 6 °C/1000 m of additional elevation.
vibration	10...57 Hz at 0.075 mm constant displacement amplitude 57...150 Hz at 1 g
shock	+/-15 g peak, 11 ms, half-sine wave

Storage Conditions

temperature	-40... 85 °C. C -40... 185 °F
humidity	0... 95% RH non-condensing at 60 °C
free fall	1 m (3 ft)



0-9

- 140 NRP 312 0•
 - description, *11*
 - specifications, *19*
 - topologies, *14*
- 140 NRP 312 00/01, *10*

F

- fiber converter module
 - 140 NRP 312 00/01, *10*
 - topologies, *14*

H

- Hot Standby
 - fiber converter modules, *14*

S

- specifications, *19*

