

Back-UPS® RS 550 Installation & Operation

Inventory

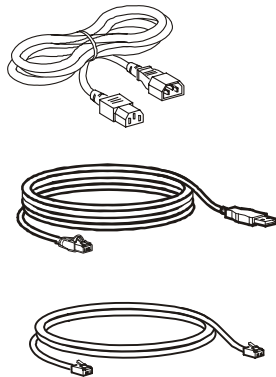
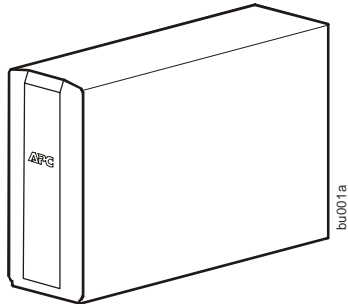

Safety

Do not install the UPS in direct sunlight, in excessive heat, humidity, or in contact with fluids.

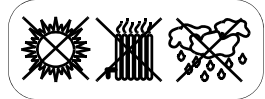

Do not connect a laser printer or hair dryer to the unit.

Ensure that the connected equipment does not exceed the maximum load.

Overview

Front panel

- ❶ Mute
- ❷ Power On/Off
- ❸ Display/Menu
- ❹ Display interface

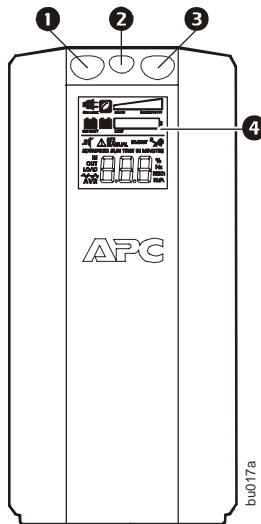

Rear Panel

- ❶ Ethernet ports
- ❷ Circuit breaker
- ❸ Master outlet
- ❹ Battery Back-UPS outlets
- ❺ Surge protected outlets
- ❻ Controlled outlets
- ❼ Data port

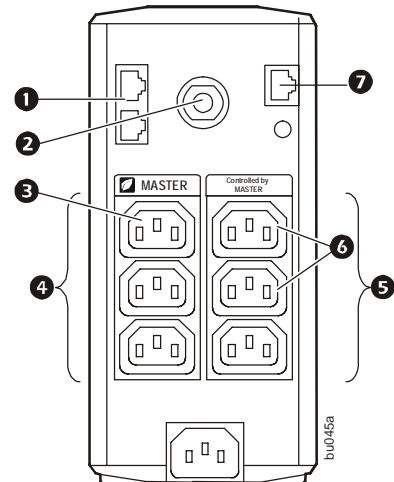

Connect the battery

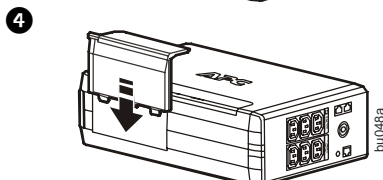
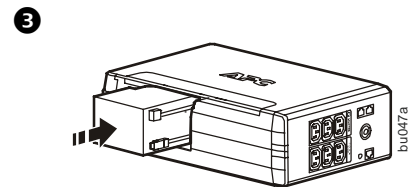
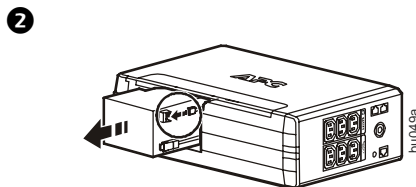
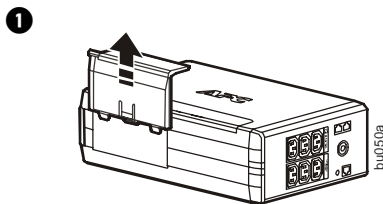

- ❺ Charge the battery for at least 16 hours before use.

Connect the equipment

Connect the equipment

1. Connect equipment to the Battery Backup and Surge Protection outlets. When the Back-UPS is receiving AC power, these outlets will supply power to connected equipment. During a power outage or other utility problems, the Battery Backup outlets receive power for a limited time from the unit.
2. Use the AC power cord to connect the Back-UPS directly to a utility power outlet.
3. Connect a router or cable modem to the corresponding ports.

Install PowerChute® Personal Edition software

1. Connect the supplied USB software interface cable to the data port, and the other end to a computer with access to the internet.
2. Go to www.apc.com/tools/download.
3. Select **PowerChute Personal Edition**. Then select the appropriate operating system and follow the instructions to download the software.

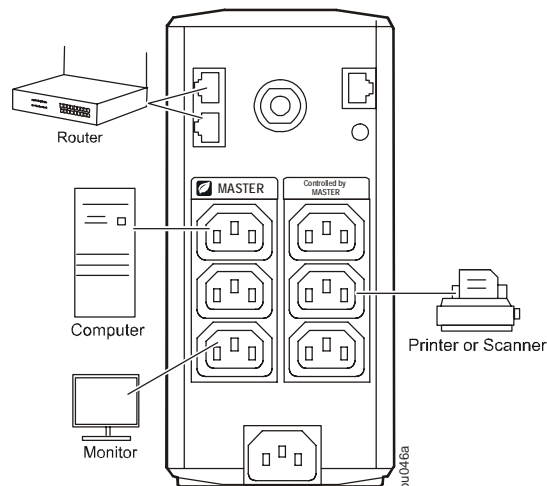

Operation

Display interface

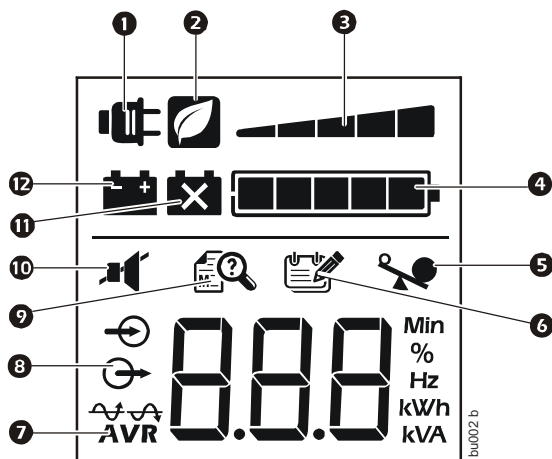

Description, if the icon is illuminated:

- ❶ **On Line**—The UPS is supplying utility power to connected equipment
- ❷ **Power-Saving**—Master and controlled outlets are enabled, saving power when the master device goes into sleep or standby mode
- ❸ **Load Capacity**—The load is indicated by the number of sections illuminated, one to five. If the load exceeds the rated capacity, the Overload symbol will flash off and on.
- ❹ **Battery Charge**—The battery charge level is indicated by the number of sections illuminated. When all five blocks are illuminated, the Back-UPS is at full charge. When one block is filled, the Back-UPS is near the end of its battery capacity, the indicator will flash and the unit will beep continuously.
- ❺ **Overload**—The power demand from the load has exceeded the capacity of the Back-UPS.
- ❻ **Event**—An event has occurred and the unit needs attention.
- ❼ **Automatic Voltage Regulation**—The unit is compensating for extremely low input voltage, but is not using battery power.
- ❽ **In**—Input voltage.
Out—Output voltage.
- ❾ **System Faults**—The system has a fault. The fault number will illuminate on the display interface. See “System Faults” on page 4.
- ❿ **Mute**—The audible alarm has been turned off.
- ⓫ **Replace Battery**—The battery is not connected or is nearing the end of its useful life. Replace the battery.
- ⓬ **On Battery**—The unit is supplying battery backup power to the connected equipment, it will beep four times every 30 seconds.

Modes of operation

Press DISPLAY to scroll through the display screens.

On Line Mode

Input Voltage
Counter
Estimated run time
Load in Watts
Load in %
Output Voltage
Output Frequency

On Battery Mode

Estimated runtime in minutes
Power Event Counter
Output Voltage
Input Voltage
Load in Watts
Load in %
Output Frequency

Other status indicators



AVR: The Automatic Voltage Regulation (AVR) feature will compensate for excessively low input voltages, without using battery power. When the AVR symbol is illuminated on the LCD, the unit is in Boost mode, using the AVR feature.

Configuration

Power-Saving Master and Controlled outlets



To conserve electricity, configure the Back-UPS to recognize a Master device, such as a desktop computer or an A/V receiver, and Controlled peripheral devices, such as a printer, speakers, or a scanner. When the Master device goes into Sleep or Standby mode, or turns OFF, the Controlled device(s) will shut down as well, saving electricity.

Enable the Power-Saving feature. Press and hold MUTE and DISPLAY simultaneously for two seconds. The unit will beep to indicate that the feature is enabled. The leaf icon on the display will illuminate.

Disable the Power-Saving feature. Press and hold MUTE and DISPLAY simultaneously for two seconds. The unit will beep to indicate that the feature is disabled. The leaf icon on the display will darken.

Setting the threshold. The amount of power used by a device in Sleep or Standby mode varies between devices. It may be necessary to adjust the threshold at which the Master outlet signals the Controlled outlets to shut down.

1. Ensure a master device is connected to the Master outlet. Put that device into Sleep or Standby mode, or turn it OFF.
2. Press DISPLAY and MUTE simultaneously and hold for six seconds, until the leaf icon flashes three times and the unit beeps three times.
3. The Back-UPS unit will now recognize the threshold level of the Master device and save it as the new threshold setting.

Power-Saving LCD Display

When unit power is On, the LCD may remain illuminated or be darkened for energy savings.

1. Full Time LCD Mode: Press and hold DISPLAY for two seconds. The LCD will illuminate and the unit will beep to confirm the Full-Time mode.
2. Power-Saving Mode: Press and hold DISPLAY for two seconds. The LCD will darken and the unit will beep to confirm the Power-Saving mode. While in Power-Saving Mode, the LCD will illuminate if a button is pressed, it then darkens after 60 seconds of no activity.

Unit sensitivity

Adjust the sensitivity of the UPS to control when it will switch to battery power; the higher the sensitivity, the more often the unit will switch to battery power.

1. Ensure the unit is connected to utility power, but is OFF.
2. Press and hold the POWER button for six seconds. The LOAD CAPACITY bar will flash on and off, indicating that the unit is in programming mode.
3. Press POWER again to rotate through the menu options. Stop at selected sensitivity. The unit will beep to confirm the selection.

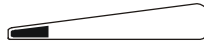

Low sensitivity

156-288 Vac

Input voltage is extremely low or high. (Not recommended for computer loads.)



Medium sensitivity

176-282 Vac

The Back-UPS frequently switches to battery power.



High sensitivity

176-276 Vac

The connected equipment is sensitive to voltage fluctuations.

Warnings and System Faults

Warnings

Press DISPLAY to scroll through the display screens.

Warning 1



ON LINE overload condition, indicated by the illuminated ON LINE icon, and the flashing overload icon.

Warning 3



In ON LINE mode, and there is a bad battery, indicated by the flashing icon.

Warning 2



Backup battery (ON BATT) overload condition. This is indicated by the flashing overload icon.

Warning 4

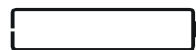

The battery charge is low, and the Battery Charge indicator bar is flashing.

System Faults

The unit will display the fault messages. Contact APC Technical Support for additional support.





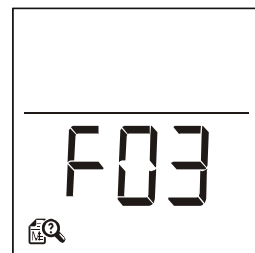









- F01 - On-Battery Overload
- F02 - On-Battery Output Short
- F03 - On-Battery Xcap Overload
- F04 - Clamp Short
- F05 - Charge Fault
- F06 - Relay Welding
- F07 - Temperature
- F08 - Fan Fault
- F09 - Internal Fault



b10021a

Function Button Quick-Reference

Function	Button	Timing (seconds)	UPS Status	Description
Power				
Power On		0.2	Off	Press POWER to start receiving input utility power. If A/C input power is not available, the unit will run on battery power.
Power Off		2	On	The unit is not receiving input utility power, but is providing surge protection.
Display				
Status Inquiry		0.2	On	Verify the status or condition of the unit. The LCD will illuminate for 60 seconds.
Full-Time/Power-Saving mode		2	On	The LCD will illuminate and the unit will beep to confirm the Full-Time mode. The LCD will darken and the unit will beep to confirm the Power-Saving mode. While in Power-Saving Mode, the LCD will illuminate if a button is pressed, then darkens after 60 seconds of no activity.
Mute				
Event Specific		0.2	On	Disable any audible alarms caused by an event.
General Status Enable/Disable		2	On	Enable or disable the audible alarms. The Mute icon will illuminate and the unit will beep one time. The Mute function will not activate unless the UPS is operating on battery power.
Sensitivity				
		6	Off	The Load Capacity icon will blink, indicating that the unit is in programming mode. Use the POWER button to scroll through Low, Medium, and High, stop at selected sensitivity. The unit will beep to confirm selection. See Configuration for details.
Master/Controlled outlet Enable/Disable				
		2	On	The leaf icon will darken indicating that the Master Outlet feature is disabled or illuminate to indicate the Master Outlet feature is enabled. The unit will beep once.
Master/Enable Threshold Calibration				
		6	On	While calibrating the threshold setting, the device connected to the Master Outlet should be turned off or placed in Standby or Sleep mode. Upon completion, Power-Saving icon will flash 3 and beep 3 times.
Self-Test (manual)				
		6	On	The UPS will perform a test of the internal battery. Note: This will happen automatically when the unit is turned ON.
Event Reset				
		0.2	On	When the Event screen is visible, press and hold DISPLAY, then press POWER, to clear the utility failure event counter.
Fault Reset				
		2	Fault	After a fault has been identified, press POWER to remove the visual indication and return to standby status.

Troubleshooting

Problem	Possible Cause	Corrective Action
Back-UPS will not switch on.	The unit is not connected to utility power.	Ensure that the unit is securely connected to an AC outlet.
	The circuit breaker has been tripped.	Disconnect non-essential equipment from the unit. Reset the circuit breaker. Re-connect equipment one item at a time. If the circuit breaker is tripped again, disconnect the device that caused the trip.
	The internal battery is not connected.	Connect the battery.
	The utility input voltage is out of range.	Adjust the transfer voltage and sensitivity range.
The unit does not provide power during a utility power outage.	Ensure that essential equipment is not plugged into a SURGE ONLY outlet.	Disconnect equipment from the SURGE ONLY outlet and re-connect to a BATTERY BACKUP outlet.
The unit is operating on battery power, while connected to utility power.	The plug has partially pulled out of the wall outlet, the wall outlet is no longer receiving utility power, or the circuit breaker has been tripped.	Ensure that the plug is fully inserted into the wall outlet. Ensure that the wall outlet is receiving utility power by checking it with another device.
	The unit is performing an automatic self test.	No action is necessary.
	The utility input voltage is out of range, the frequency is out of range, or the waveform is distorted.	Adjust the transfer voltage and sensitivity range.
The unit does not provide the expected amount of backup time.	Battery Backup outlets may be fully or improperly loaded.	Disconnect non-essential equipment from the BATTERY BACKUP outlets and connect the equipment to SURGE ONLY outlets.
	The battery was recently discharged due to a power outage and has not fully recharged.	Charge the battery cartridge for 16 hours.
	The battery has reached the end of its useful life.	Replace the battery.
The REPLACE BATTERY indicator is illuminated.	The battery has reached the end of its useful life.	Replace the battery.
The OVERLOAD indicator is illuminated.	The equipment connected to the unit is drawing more power than the unit can provide.	Disconnect non-essential equipment from the BATTERY BACKUP outlets and connect the equipment to SURGE ONLY outlets.
The SYSTEM FAULT indicator is illuminated, all the front panel indicators are flashing.	There is an internal fault.	Determine which internal fault message is displayed by matching the number displayed on the LCD with the corresponding Fault Message (see System Faults) and contact APC Technical Support.
Power is not supplied to some outlets.	Power to the Controlled Outlets has intentionally been turned off.	Confirm that the correct peripherals are connected to Controlled Outlets. If this feature is not desired, disable the Power-Saving Master and Controlled Outlets.
The Controlled Outlets are not supplying power, even though the Master device is not in sleep mode.	The Master Outlet threshold may be incorrectly set.	Adjust the threshold when the Master outlet signals the Controlled Outlets to shut down.

Specifications

VA	550 VA
Maximum Load	330 W
Nominal Input Voltage	230 V
Online Input Voltage Range	176 - 282 V
Frequency Range	50/60 Hz \pm 1 Hz
On-battery Waveshape	Step-approximated sine-wave
Typical Recharge Time	12 hours
Transfer Time	8 ms, maximum
Operating Temperature	32° to 104°F (0° to 40°C)
Storage Temperature	23° to 113°F (-5° to 45°C)
Unit Weight	14.8 lbs (6.7 kg)
Interface	USB
EMI Classification	CE, C-Tick, KETI
Approvals	CE, TUV-GS, GOST, A-Tick, KETI, TISI

APC Worldwide Customer Support

Technical Support	http://www.apc.com/support
Internet	http://www.apc.com
Worldwide	+1 800 555 2725

Service

If the Back-UPS arrived damaged, notify the carrier.

If the Back-UPS requires service, do not return it to the dealer.

1. Consult the Troubleshooting section to eliminate common problems.
2. If the problem persists, go to <http://www.apc.com/support/>.
3. If the problem still persists, contact APC Technical Support. Have the Back-UPS model number, serial number and date of purchase available. Be prepared to troubleshoot the problem with an APC Technical Support representative. If this is not successful, APC will issue a Return Merchandise Authorization (RMA) number and a shipping address.

Warranty

The standard warranty is three (3) years from the date of purchase in the European Community. For all other regions, the standard warranty is two (2) years from the date of purchase. The APC standard procedure is to replace the original unit with a factory reconditioned unit. Customers who must have the original unit back due to the assignment of asset tags and set depreciation schedules must declare such a need at first contact with an APC Technical Support representative. APC will ship the replacement unit once the defective unit has been received by the repair department, or cross-ship upon the receipt of a valid credit card number. The customer pays for shipping the unit to APC. APC pays ground freight transportation costs to ship the replacement unit to the customer.

Customer support and warranty information is available at the APC Web site, www.apc.com.

