

User Manual Easy-UPS™ On-Line SRV5KL-IN and SRV6KL-IN

Important Safety Information

SAVE THESE INSTRUCTIONS - This manual contains important instructions that should be followed during installation and maintenance of the Easy-UPS and batteries.

Read these instructions carefully and look at the equipment to become familiar with the device before trying to install, operate, service or maintain it. The following special messages may appear throughout this bulletin or on the equipment to warn of potential hazards or to call attention to information that clarifies or simplifies a procedure.



The addition of either symbol to a “Danger” or “Warning” safety label indicates that an electrical hazard exists which will result in personal injury if the instructions are not followed.



This is the safety alert symbol. It is used to alert you to potential personal injury hazards. Obey all safety messages that follow this symbol to avoid possible injury or death.

DANGER

DANGER indicates a hazardous situation which, if not avoided, will result in death or serious injury.

WARNING

WARNING indicates a hazardous situation which, if not avoided, could result in death or serious injury.

CAUTION

CAUTION indicates a hazardous situation which, if not avoided, could result in minor or moderate injury.

NOTICE

NOTICE is used to address practices not related to physical injury.

Product Handling Guidelines



<18 kg
<40 lb



18-32 kg
40-70 lb



32-55 kg
70-120 lb



>55 kg
>120 lb



Safety and General Information

Inspect the package contents upon receipt. Notify the carrier and dealer if there is any damage.

- This Easy-UPS is for indoor use only.
- Do not operate this Easy-UPS in direct sunlight, in contact with fluids, or where there is excessive dust or high humidity.
- Do not operate the Easy-UPS near open windows or doors.
- Be sure the air vents on the Easy-UPS are not blocked. Allow adequate space for proper ventilation.
Note: Allow a minimum of 20 cm clearance on both front and rear sides of the Easy-UPS.
- Upto 10 XLBPs can be connected to the Easy-UPS in parallel.
Note: For each XLBP added, increased recharge time will be required.
- Environmental factors impact battery life. Elevated ambient temperatures, poor quality utility power, and frequent discharges will shorten battery life. Follow the battery manufacturer recommendations.
- Connect the Easy-UPS power cable directly to a wall outlet. Do not use surge protectors or extension cords.

Electrical safety

- When grounding cannot be verified, disconnect the equipment from the utility power outlet before installing or connecting to other equipment. Reconnect the power cord only after all connections are made.
- Connection to the branch circuit (mains) must be performed by a qualified electrician.
- The protective earth conductor for the UPS carries the leakage current from the load devices (computer equipment). An insulated ground conductor is to be installed as part of the branch circuit that supplies the UPS. The conductor must have the same size and insulation material as the grounded and ungrounded branch circuit supply conductors. The conductor will be green and with or without a yellow stripe.

- The grounding conductor is to be grounded to earth at the service equipment, or if supplied by a separately derived system, at the supply transformer or motor generator set.

Battery safety

- APC by Schneider Electric uses Sealed Maintenance-Free VRLA batteries. Under normal use and handling, there is no contact with the internal components of the batteries. Over charging, over heating or other misuse of batteries can result in leakage of battery electrolyte. Released electrolyte is toxic and may be harmful to the skin and eyes.
- Use tool with insulated handles.
- Wear rubber gloves and boots.
- Determine if battery is either intentionally or inadvertently grounded. Contact with any part of a grounded battery can result in electric shock or burns by high short-circuit current. The risk of such hazards can be reduced if grounds are removed during installation and maintenance by a skilled person.
- CAUTION: Before installing or replacing the batteries, remove jewelry such as wristwatches and rings. High short circuit current through conductive materials could cause severe burns.
- CAUTION: Do not dispose of batteries in a fire. The batteries may explode.
- CAUTION: Do not open or mutilate batteries. Released material is harmful to the skin and eyes and may be toxic

Radio Frequency Warning

This is a category C2 UPS product. In a residential environment, this product may cause radio interference, in such a case the user may be required to take additional measures.

Product Description







The APC by Schneider Electric Easy-UPS is a high performance, uninterruptible power supply (UPS). The Easy-UPS provides protection to electronic equipment from utility power blackouts, brownouts, sags, surges, small utility fluctuations and large disturbances. The Easy-UPS also provides battery backup power to connected equipment until utility power returns to normal levels or the batteries are fully discharged.

This user manual is available on the enclosed Documentation CD and on the APC by Schneider Electric website, www.apc.com.

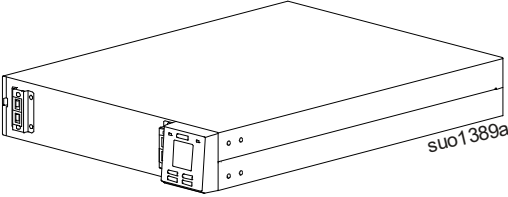
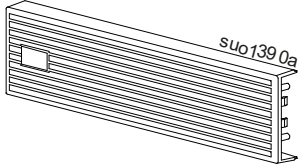
Package Contents

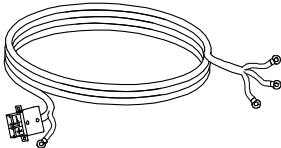
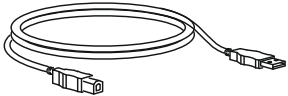
Read the Safety Guide before installing the Easy-UPS.

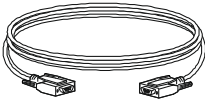
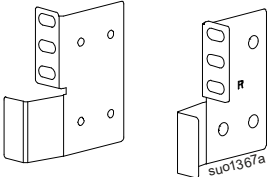
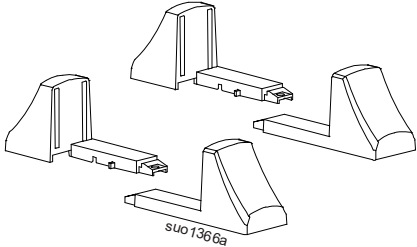
The packaging is recyclable; save it for reuse or dispose of it properly.:

<p>Easy-UPS</p>  <p>su01389a</p>	<p>Front bezel</p>  <p>su01390a</p>	
<p>User Manual</p> 	<p>Battery cable</p> 	<p>USB cable</p> 
<p>Software, User documentation CD</p> 	<p>Serial communication cable</p> 	<p>Rackmount bracket x1 pair</p>  <p>su01367a</p>
<p>Stabiliser brackets x2 pairs</p>  <p>su01366a</p>		<p>Flat head screws x8</p>  <p>Pan head screws x4</p> 

NOTE: The model and serial numbers are located on a small, rear panel label.

Optional Accessories

Refer to the APC by Schneider Electric website, www.apc.com, for available accessories.

Specifications

Environmental specifications

NOTICE

RISK OF EQUIPMENT DAMAGE

- Easy-UPS must be used indoors only.
- The installation location should be sturdy to withstand the weight of the Easy-UPS.
- Do not operate Easy-UPS where there is excessive dust or where the temperature or humidity are outside specified limits.

Failure to follow these instructions can result in equipment damage.

Temperature	Operating	0 °C to 40 °C at rated load 40 °C to 45 °C linearly derated to 85% of maximum load capacity 45 °C to 50 °C linearly derated to 75% of maximum load capacity
	Storage	-20 °C to 60 °C
Elevation	Operating	0 - 1,000 m: normal operation 1,000 - 3,000 m: The load is derated @ 1% for every 100 m increase in height. >3,000 m: Easy-UPS will not work
	Storage	0 - 15,000 m
Humidity		0 to 95% relative humidity, non-condensing
IP Rating		IP 20

Note: Charge the battery module atleast every six months during storage

Physical specifications

	SRV5KL-IN	SRV6KL-IN
Dimensions with package Width x Height x Depth	600 mm x 240 mm x 760 mm (23.62 in x 9.45 in x 29.92 in)	
Dimensions without package Width x Height x Depth	438 mm x 86.5 mm x 615 mm (17.2 in x 3.41 in x 24.21 in)	
Weight with package	18 kg	
Weight without package	15 kg	

Input/Output specifications

		SRV5KL-IN	SRV6KL-IN
Input	Nominal input voltage	230 Vac nominal	
	Input frequency	50/60 Hz nominal	
	Input voltage range (100% load)	176 Vac - 300 Vac \pm 3%	
	Input voltage range (80% load)	150 Vac - 176 Vac	
	Input voltage range (60% load)	110 Vac - 150 Vac	
	Input power factor (100% load resistive load at nominal voltage)	\geq 0.99 at 100% load	
	Input protection	Circuit breaker	
Output	Easy-UPS Capacity	5000 VA / 5000 W	6000 VA / 6000 W
	Nominal output voltage	230 Vac	
	Other programmable voltage	220 Vac, 240 Vac	
	Efficiency at rated load	\geq 94% max.	
	Output voltage regulation	\pm 1% static	
	Output voltage distortion	<ul style="list-style-type: none"> • 1% max. for full linear load • 4% max. for full RCD load (100% VA, 0.8 PF) 	
	Frequency - On battery	50 Hz \pm 0.1 Hz / 60 Hz \pm 0.1 Hz	
	Frequency - AC mode	50 Hz \pm 3 Hz / 60 Hz \pm 3 Hz	
	Crest factor	3:1	
	Waveform	Sinewave	
	Output connection	Terminal Block	
	Bypass	Internal	
	Bypass range	185 Vac to 250 Vac \pm 1%	

Battery

CAUTION

RISK OF HYDROGEN SULPHIDE GAS AND EXCESSIVE SMOKE

- Replace the battery at least every 5 years.
- Replace the battery immediately when the Easy-UPS indicates battery replacement is necessary.
- Replace battery at the end of its service life.
- Replace batteries with the same number and type of batteries as originally installed in the equipment.
- Replace the battery immediately when the Easy-UPS indicates a battery over-temperature condition, or Easy-UPS internal over-temperature, or when there is evidence of electrolyte leakage. Power off the Easy-UPS, unplug it from the AC input, and disconnect the batteries. Do not operate the Easy-UPS until the batteries have been replaced.

Failure to follow these instructions could result in minor or moderate injury and equipment damage.

	SRV5KL-IN	SRV6KL-IN
Configuration	External battery	
Type	Sealed maintenance free (SMF) 12 V,9 Ah	
Battery bank voltage	240 V	

Tower Installation

⚠ CAUTION

RISK OF FALLING EQUIPMENT

- The Easy-UPS is heavy.
- Always practice safe lifting techniques adequate for the weight of the equipment.
- Ensure that the stabilizer brackets are installed when the Easy-UPS is installed in the tower orientation.

Failure to follow these instructions can result in minor or moderate injury and equipment damage.

Note: Rotate the Front Panel Display before commencing Tower Installation. Refer “Front Panel Display Rotation” on page 10 for details.

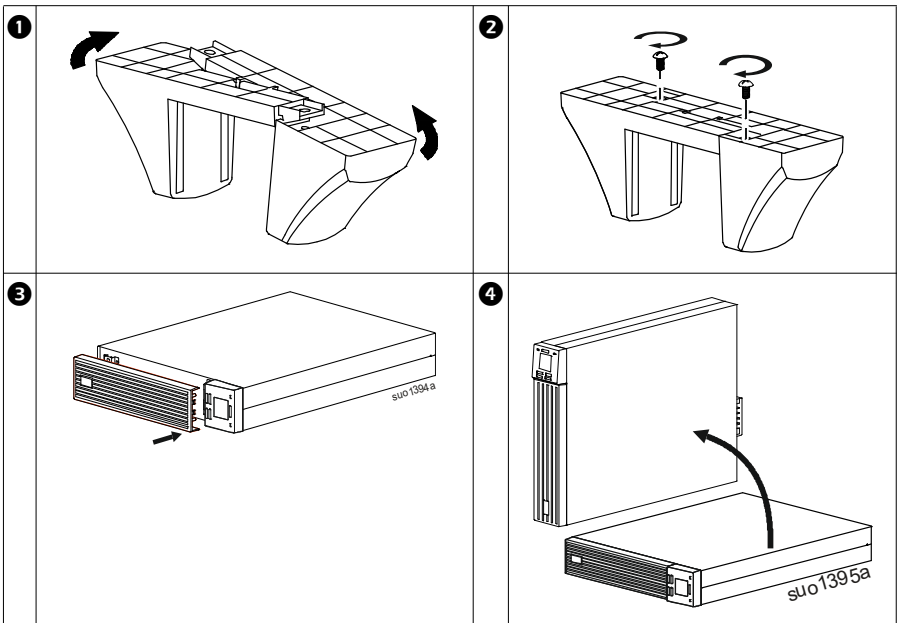

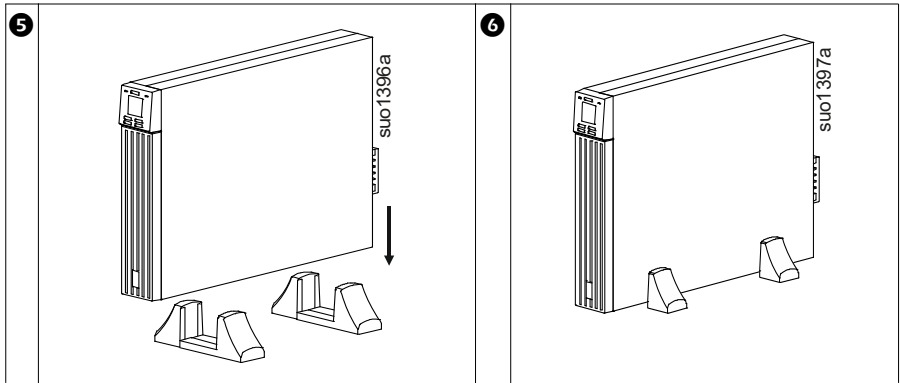

Note: Maintain atleast 70 mm distance from the edge of the unit, when installing the stabilizer brackets to the Easy-UPS.

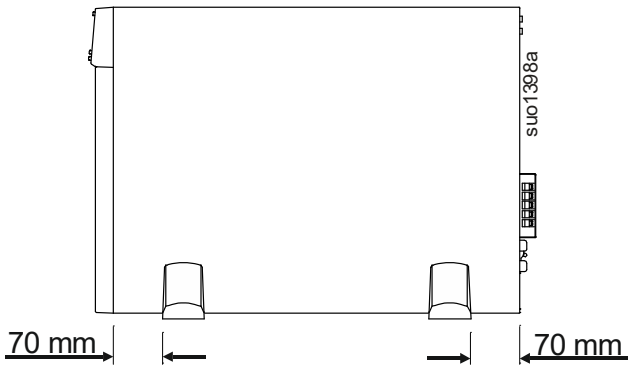

Front Panel Display Rotation

Follow below steps to rotate the front panel display module.

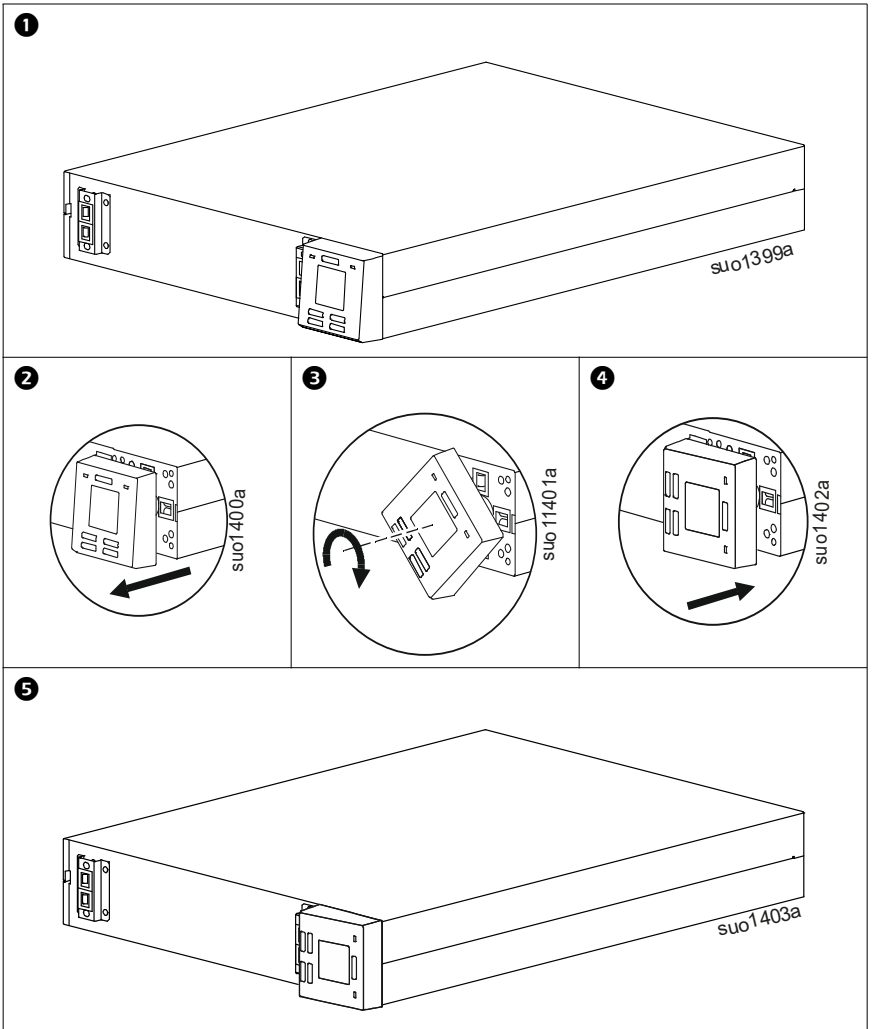

Rack-Mount Installation

⚠ CAUTION

RISK OF FALLING EQUIPMENT

- The Easy-UPS is heavy.
- Always practice safe lifting techniques adequate for the weight of the equipment.
- Always use the recommended number of screws to secure brackets to the UPS.
- Given the heavy weight, the use of rack-mount brackets is mandatory during rack installation (guide with L-shaped support).
- Always install the UPS at the bottom of the rack.
- Install the Easy-UPS above the external battery pack (XLBP).
- Secure the unit in the rack using all the screws supplied for the purpose.

Failure to follow these instructions can result in minor or moderate injury

It is recommended to use the SRVRK2 Rail kit for installing the Easy-UPS in rack-mount configuration.

❶ Install the rack-mount brackets

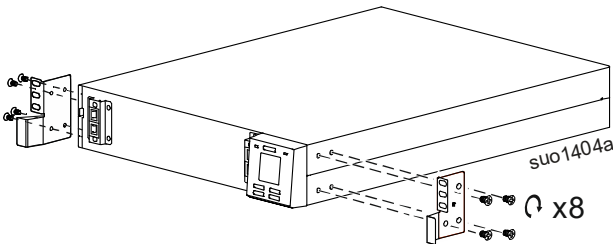

2 Lift the Easy-UPS module and slide it into rack enclosure.

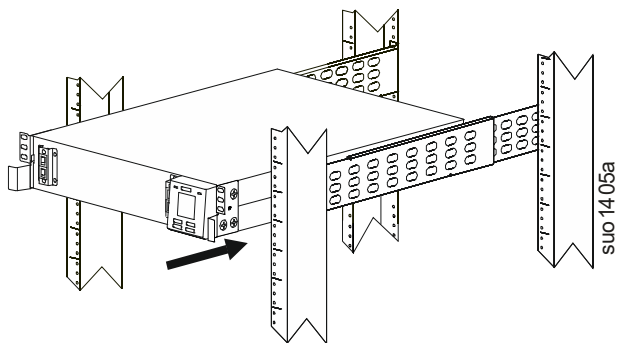

3 Secure the Easy-UPS module to the rack with screws, nuts and washers (not supplied in the package)

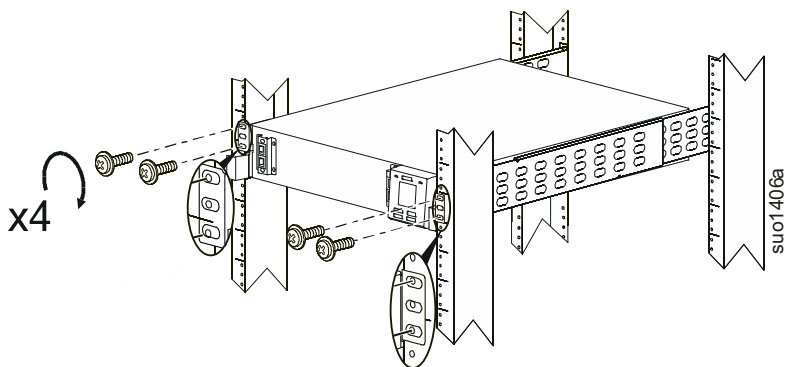

4 Install the front bezel

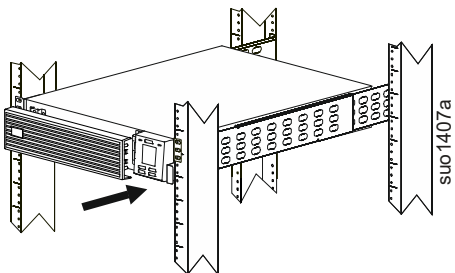

Rear Panel Features

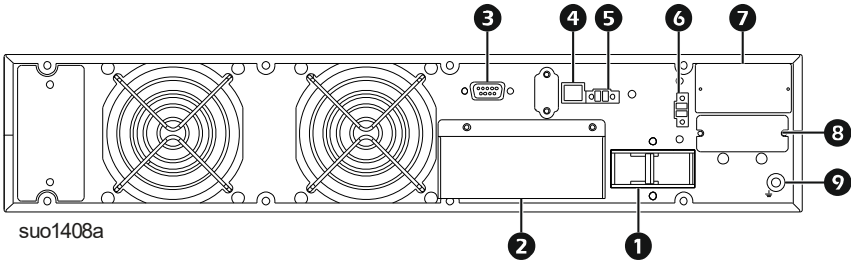

1	Input circuit breaker.	5	Emergency power off connector.
2	Input and output terminals. Refer “Output and Input Hardwire Instructions” on page 14 for details.	6	External maintenance bypass signal port.
3	Serial communication port.	7	Intelligent card slot.
4	USB port.	8	Battery connector.
		9	Ground screw.

Output and Input Hardwire Instructions

⚠ CAUTION

RISK OF ELECTRIC SHOCK

- Adhere to all national and local electrical codes.
- All electrical work must be performed by a qualified electrician.
- Turn off all power to this equipment before working on the equipment.
- Switch the external circuit breaker off. Practice lockout/tagout procedures.
- Do not wear jewelry when working with electrical equipment.
- Select wire size and connectors according to national and local codes.

Failure to follow these instructions can result in moderate injury.

⚠ WARNING

RISK OF VOLTAGE BACKFEED

- There is no standard backfeed protection inside the UPS. Isolate both AC and DC supply of the UPS.
- Check for hazardous voltages between all terminals including protective earth.

Failure to follow this instruction can result in death or serious injury.

Be sure to isolate the Easy-UPS before working on it. Isolation should be provided as per the circuit below and the isolation device should be capable of carrying the UPS input current.

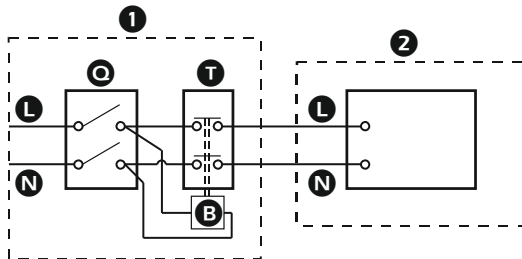

1	External Distribution Panel	2	Smart-UPS
L	Line input	N	Neutral input

ⓐ	Magneto-Thermal input main switch	Ⓣ	AC contactor as back-feed protection device
ⓑ	Coil remote switch		

Input and Output terminals

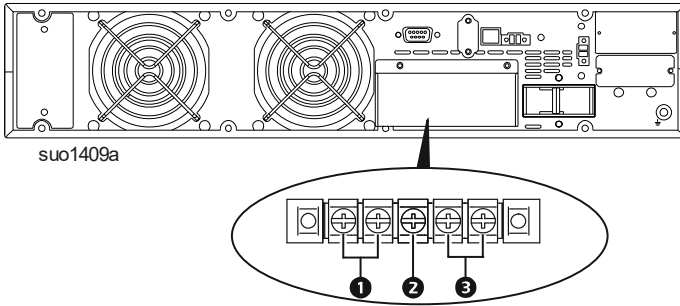

1	Output connection terminals
2	Ground connection terminal
3	Input connection terminals

1. Use 8 AWG wire (not supplied) to hard wire the input and output connections.
2. For connecting the wire to the input/output terminals recommend to use insulated ring type lug (not supplied) suitable for M5 screw.
3. Locate the hardwire terminal block cover on rear panel of Easy-UPS. Remove the screws securing the cover and remove the cover.
4. Connect the line and neutral wires of the equipment to the output terminals in the terminal block.
5. Connect the line and neutral wires from the utility power to the input terminals in the terminal block.
6. Connect the protective earth wire from the utility power to the ground terminal in the terminal block.
7. Replace and secure the cover removed in *step 1*.

Connect the Easy-UPS to a battery system

CAUTION

RISK OF ELECTRIC SHOCK

- Adhere to all national and local electrical codes.
- All electrical work must be performed by a qualified electrician.
- Identify the polarities of the battery terminals before connecting the battery. Be sure grounding (green cable) is connected firmly.
- Do not short the battery terminals.
- Do not wear jewelry when working with electrical equipment.

Failure to follow these instructions can result in moderate injury.

NOTICE

RISK OF IMPROPER CONNECTION

Connect the battery according to the battery voltage indicated on the rear panel. If the connected battery voltage is incorrect, UPS may be damaged and cannot be repaired. Therefore, be sure to confirm that the battery voltage is in accordance with the UPS specification.

Failure to follow these instructions could result in equipment damage.

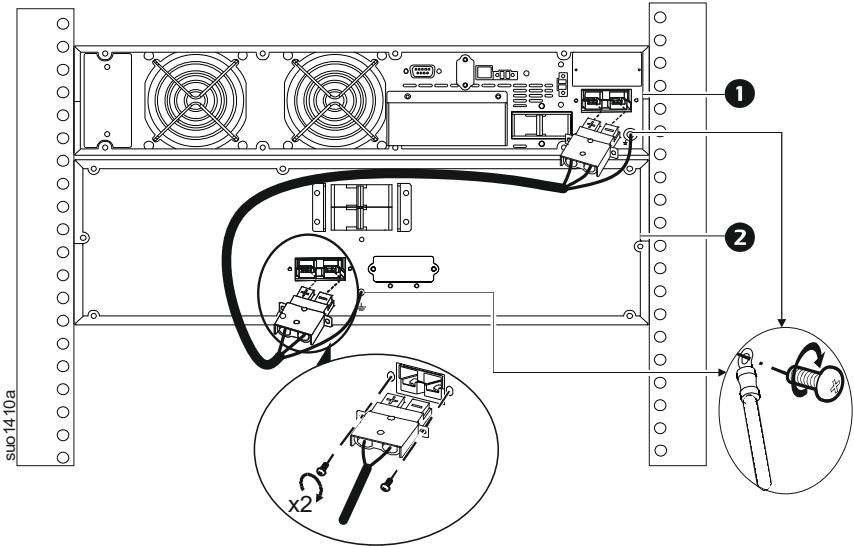

❶	Easy-UPS
❷	XLBP

1. Locate the battery connector cover on rear panel of Easy-UPS and XLBP. Remove the screws securing the cover and remove the cover.
2. Use the battery connection cable supplied with the XLBP.
3. Plug one end of the external battery cable connector into the battery connector receptacle on the rear side of the Easy-UPS and the other end of the external battery cable connector into the battery connector receptacle on the rear side of the XLBP.
4. Insert the screws removed in step 1 and tighten the screws to secure the external battery connector receptacle to the battery connector on the rear panel of Easy-UPS and XLBP.

Start Up

Connect equipment and input power to the Easy-UPS

CAUTION

RISK OF ELECTRIC SHOCK

- All electrical work must be performed by a qualified electrician.
- Turn off all power to this equipment before working on the equipment.
- Practice lockout/tagout procedures.
- Do not wear jewelry when working with electrical equipment.
- Disconnect the mains power and external batteries before installing or servicing the Easy-UPS or connected equipment.
- Do not use the Easy-UPS as safety disconnect.

Failure to follow these instructions can result in moderate injury.

1. Connect equipment to Easy-UPS (cables not supplied). Avoid using extension cords. Refer “Output and Input Hardwire Instructions” on page 14 for details.
2. Connect external batteries to Easy-UPS. Refer “Connect the Easy-UPS to a battery system” on page 16 for details.
3. Connect input utility power to the Easy-UPS.
4. Switch the utility input circuit breaker on. The display panel will illuminate when utility power is available.

Set up the total battery capacity connected to the Easy-UPS

WARNING

RISK OF FIRE

Select the correct Total Battery Ah of the XLBPs connected to the Easy-UPS.

Failure to follow this instruction could result in death or serious injury.

Go to the display menu settings, select the Battery Ah based on the total capacity of the XLBPs connected to the Easy-UPS. By default, Easy-UPS is set for 9 Ah.

Capacity of each XLPB is 9 Ah. When connecting multiple XLPBs to the Easy-UPS, add the capacity of all the XLPBs connected to determine the total capacity of the battery bank and set this value as the Battery Ah.

Start the Easy-UPS

Press and hold the POWER ON/OFF button located on the front panel of Easy-UPS until a beep is heard. The **Status** LED will illuminate green.

Register the Easy-UPS when it is started for the first time. Refer “Easy-UPS Registration” on page 20 for details.

- The battery charges to 90% capacity during the first five hours of normal operation.
- **Do not** expect full battery run capability during this initial charge period.

Cold start the Easy-UPS

Use cold start feature to supply power to connected equipment from the Easy-UPS batteries.

Press and hold the POWER ON/OFF button located on the front panel of Easy-UPS until a beep is heard. The display panel will illuminate.

Press the POWER ON/OFF button again to supply battery power to the connected equipment.

Turn Easy-UPS OFF

WARNING

RISK OF ELECTRIC SHOCK

The output terminals of the Easy-UPS are energised as long as the utility circuit breaker is on and the input voltage is applied to the input terminals. Be sure to turn off the utility circuit breaker to de-energise the output terminals.

Failure to follow this instruction could result in death or serious injury.

To turn off the Easy-UPS, press and hold the POWER ON/OFF button on the front display panel until a beep is heard. Output power will still be available through bypass.

Connect and install management software

Easy-UPS is provided with SchneiderUPS management software for unattended operating system shutdown, monitoring, control and energy reporting. The following diagram is a representation of a typical server installation.

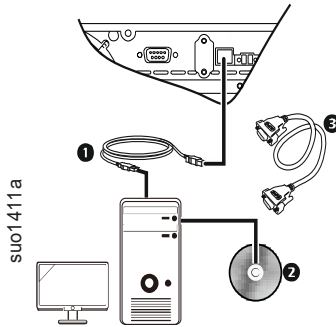

❶	Connect the USB cable from the rear of the Easy-UPS to the computer.
❷	Load the SchneiderUPS CD and follow the on-screen set-up instructions.
❸	A built-in serial port is also available for additional communication options with serial cable.

Additional communication options are available via the built-in intelligent card slot. Refer to www.apc.com for more information.

Easy-UPS Registration

Register the Easy-UPS with APC by Schneider Electric customer support. This is a one time process required to be done only during initial installation. The Easy-UPS output cannot be turned on without successfully completing registration process. After successful completion of the registration process, the Easy-UPS will function normally.

1. When the Easy-UPS is started up for the first time after installation, the display screen will display 3 numeric digits, “ON LINE”, “ON BATT”, “BYPASS” and “ALARM” symbols (refer “Front display panel features” on page 23 for details) on the display get illuminated. All other symbols are not illuminated.
2. Call APC by Schneider Electric Customer Support on the toll free number given in page 36 for obtaining the 3 digit Personal Identification Number (PIN).

3. Press the ENTER button to enter the 3 digit PIN given by APC by Schneider Electric Customer Support. When the ENTER button is pressed, all the 3 displayed digits change to '0' and the first digit flashes every 1 second. Use the UP ARROW button to increment the flashing digit or the DOWN ARROW button to decrement the flashing digit till the first digit of the PIN is displayed. Press the ENTER button to accept the flashing digit and move to enter the second digit of the PIN. Repeat this process till all the 3 digits of the PIN are entered.
4. After successful entry of the PIN, a long beep will be heard and the home screen is displayed on the Easy-UPS.
5. If the authentication of the PIN fails, then a new 3 digit number is displayed and *steps 2 to 4* have to be repeated.

Emergency Power Off

NOTICE

RISK OF EQUIPMENT DAMAGE

Do not connect the EPO interface to any circuit other than an unused circuit.

Failure to follow these instructions can result in equipment damage.

The Emergency Power Off (EPO) function is a feature that will immediately remove power to all connected equipment. When EPO button is pressed, all connected equipment will immediately turn off and will not switch to battery power.

Adhere to all national and local electrical codes. Wiring must be performed by a qualified electrician.

The EPO switch is internally powered by the Easy-UPS for use with non-powered switches or potential free normally closed (N/C) contacts.

Connecting normally closed (N/C) contacts

- 1 Loosen the screws of terminals 1 and 2 in the EPO connector.

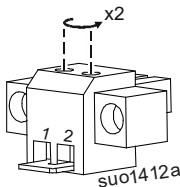

- 2 Remove the metal link between pins 1 and 2.

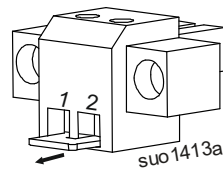

- 3 Connect N/C relay contacts between pins 1 and 2 of the EPO terminal block. Use 0.5 to 1 mm² wire.

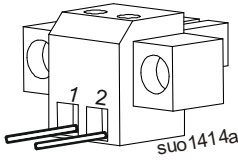

- 4 Secure the EPO connector screws beneath pins 1 and 2.

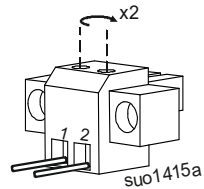

Note: If the N/C is open, the Easy-UPS will turn off and power will be removed from the load.

The EPO interface is a Safety Extra Low Voltage (SELV) circuit. Connect it only to other SELV circuits. The EPO interface monitors circuits that have no determined voltage potential. Such closure circuits may be provided by a switch or relay properly isolated from the utility. To avoid damage to the Easy-UPS, do not connect the EPO interface to any circuit other than a unused circuit.

Use one of the following cable types to connect the Easy-UPS to the EPO switch.

- CL2: Class 2 cable for general use.
- CL2P: Plenum cable for use in ducts, plenums, and other spaces used for environmental air.
- CL2R: Riser cable for use in a vertical run in a floor-to-floor shaft.

Operation

Front display panel features

Easy-UPS models are equipped with an intuitive and configurable LCD display. The display complements the software interface as they convey similar information and either may be used to configure the Easy-UPS settings.



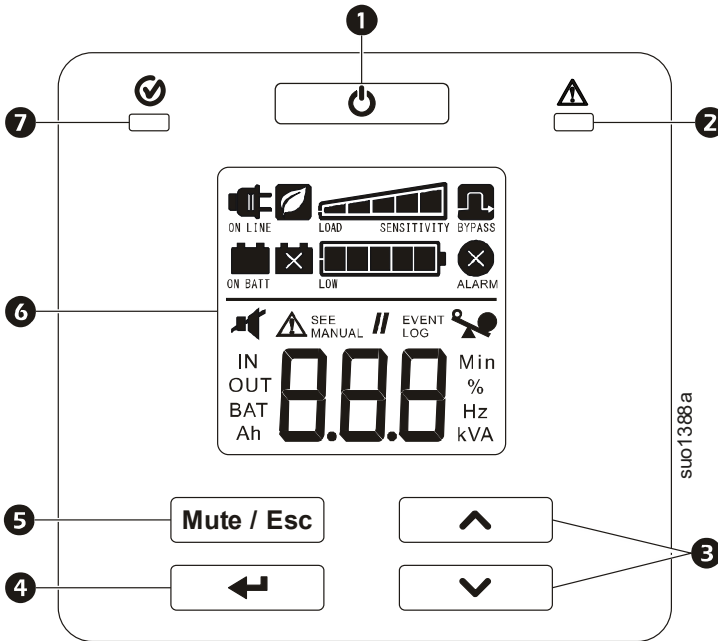





The display consists of the following keys and indicators:







1	POWER ON/OFF button	Press the POWER ON/OFF button to turn the Easy-UPS ON. Press and hold the POWER ON/OFF button until a beep is heard to turn OFF the Easy-UPS. Output will still be available through bypass. Press the POWER ON/OFF button to reset alerts.
2	Alert LED	The Alert LED illuminates red when the Easy-UPS detects an error and blinks red for Easy-UPS notifications. Refer “Alerts and Notifications” on page 31 for details.
3	UP/DOWN ARROW button	Press the UP/DOWN ARROW button to scroll through the main menu options and display screens.
4	ENTER button	Press the ENTER button to enter the menu or to select a menu item/value during navigation.

5	MUTE/ESC button	<p>Press the MUTE/ESC button:</p> <ul style="list-style-type: none"> • To acknowledge audible alerts and suppress them temporarily. • To exit a sub menu and return to the main menu.
6	LCD Display	<p>The display interface options are visible on this LCD screen. Press any button to activate LCD, if the display is not illuminated.</p>
7	Status LED	<p>The Status LED illuminates green when the power is on. The LED indicates two different states of output power:</p> <ul style="list-style-type: none"> • Output off: LED blinks on and off. Press POWER ON/OFF button to turn the output power on. • Output on: LED illuminates green continuously.

Display icons

	<p>On Line: The Easy-UPS is drawing utility power and performing double conversion to supply power to the connected equipment.</p>
	<p>On Battery: The Easy-UPS is supplying battery backup power to the connected equipment.</p>
	<p>Replace Battery: The battery is not connected securely or the battery is nearing the end of its service life and should be replaced.</p>
	<p>Bypass: The Easy-UPS is in bypass mode, sending utility power directly to connected equipment. Bypass mode operation is the result of an internal UPS event, an overload condition, or a user initiated command either through an accessory. Battery operation is not available while the Easy-UPS is in bypass mode. Refer “Alerts and Notifications” on page 31 for details. This icon in combination with Green Mode icon, indicates that the Easy-UPS is in green mode operation.</p>
	<p>System Alerts: The Easy-UPS has detected an internal fault. See “Alerts and Notifications” on page 31 in this manual.</p>
	<p>Overload: The equipment connected to the Easy-UPS is drawing more power than rated.</p>
	<p>Battery Charge: The battery charge level is indicated by the number of bar sections illuminated. When all five blocks are illuminated, the battery is fully charged. Each bar represents approximately 20% of the battery charge capacity.</p>
	<p>Load Level: The load percentage is indicated by the number of load bar sections illuminated. Each bar represents approximately 20% of the load.</p>

	Mute: An illuminated line through the icon indicates that the audible alert is disabled.
	Green Mode: An illuminated icon indicates that the unit is working in Green mode. The connected equipment is receiving the utility input directly as long as the input voltage and frequency are within the configured limits.
	Alert or notification: The Easy-UPS has detected an error or the Easy-UPS is in configuration mode. Refer “Alerts and Notifications” on page 31 for details.
	Event: The icon is illuminated when the user is viewing the event log.

Status Indicators

Audible Alert	Condition
Continuous beeps, every half second	Low Battery State - The battery is nearing its discharge state. The Easy-UPS is about to shutdown. Overload condition - The equipment connected to the Easy-UPS is drawing more power than rated.
4 beeps every 30 sec (first beep starts after 4 sec on battery)	On Battery State - The Easy-UPS is supplying battery backup power to the connected equipment.
Continuous beeps	Alert State - Easy-UPS has detected an error. Refer “Alerts and Notifications” on page 31 for details.
Two short beeps every 5 sec	Event Bypass State - Easy-UPS has detected an error. Connected equipment receives utility input power through the bypass relay.

Easy-UPS Display Parameters

Operational data displayed in the display panel is given in the table. Navigate using the UP/DOWN ARROW buttons.

Parameter	Units	Indicator Icons
Output voltage	Vac	OUT, V
Output frequency	Hz	OUT, Hz
Input voltage	Vac	IN, V
Input frequency	Hz	IN, Hz
State of battery charge	%	BAT, %
Battery voltage	V DC	BAT, V
Battery charging current	A DC	BAT, A
Ambient temperature	°C	NUMBER, C
Remaining On Battery runtime	Minutes	BAT, Min

Parameter	Units	Indicator Icons
Load level in percentage (Maximum of Watts or VA)	%	OUT, %
Load level in kVA	kVA	OUT, kVA
Total Ah capacity of connected battery	Ah	BAT, Ah

Configuration

Easy-UPS settings



Configure Easy-UPS settings using the display interface. Refer “Configure Easy-UPS parameters” on page 28 to edit the parameters.







Function	Factory Default	User Selectable Options	Description
Output voltage	230 Vac	220, 230, 240 Vac	Allows the user to select output voltage while the Easy-UPS is operating online.
Audible alert	Enable	Enable; Disable	Allows the user to mute the audible alerts of the Easy-UPS when set to disable or when the display panel buttons are pressed.
Green mode/ high efficiency mode	Disabled	Enable; Disable	When this mode is enabled, connected equipment receives utility input power through the bypass relay as long as input voltage is within the range of $\pm 5\%$ of configured output voltage and ± 4 Hz of configured output frequency. Inverter is turned off during this mode. If utility power input goes out of range, inverter is turned on. The load is transferred to online mode or battery mode. The power to the connected equipment may be interrupted up to 10 milliseconds.
Battery Ah capacity	9 Ah	7 ~ 120 Ah	Allows the user to set the Total Ah of the batteries connected to the Easy-UPS.
Output voltage adjustment	230 Vac	220 \pm 0~9 V 230 \pm 0~9 V 240 \pm 0~9 V	Allows the user to adjust the output voltage by using the UP/DOWN ARROW button. This parameter can be set either in line mode or battery mode.

Function	Factory Default	User Selectable Options	Description
Inverter voltage adjustment	Add 0	Add 000 ~ 09.9 V Sub 000 ~ 09.9 V	Allows the user to adjust the inverter voltage by choosing Add or Sub. The voltage range is from 0 V to 9.9 V. The default value is 0 V. This parameter can be set either in line mode or battery mode.

Advanced Display Navigation

The Easy-UPS display has five menu options in the main menu and two sub-menu options in the UPS display. Press the ENTER button from the Home Screen to access these menu options. Use the UP/DOWN ARROW buttons to navigate between the menu options.

Menu option	Description
	Configure the Easy-UPS Use this menu option to configure the Easy-UPS parameters. Press the ENTER button to see the configuration options. Refer “Configure Easy-UPS parameters” on page 28 for details. Press the MUTE/ESC button to return to the Home Screen.
	Show Event Log Use this menu option to see the Easy-UPS event log. The Easy-UPS records the last 10 events and displays the codes in this log. Press the ENTER button to see the log. Use the UP/DOWN ARROW buttons to see the logged events. The DOWN ARROW button navigates towards old events and the UP ARROW button navigates to new events. Every log entry has a numeric and textual event code. At the end of the log, the word “End” will be displayed. Press the MUTE/ESC button to return to the Home Screen.
	Show Easy-UPS information Use this menu option to see the Easy-UPS information. Press the ENTER button to see the rating of the Easy-UPS. Press the UP ARROW button to see the Easy-UPS firmware version. Press the MUTE/ESC button to return to the Home Screen.

Menu option	Description
	<p>User Command to bypass Use this menu option to switch the Easy-UPS to bypass mode or bring the Easy-UPS to online mode from bypass mode. Press ENTER button:</p> <p> Put: Use to switch the Easy-UPS to bypass mode of operation. Note: Power to the connected equipment will drop, if the mains voltage is not within the threshold limits.</p> <p> Out: Bring the Easy-UPS out of bypass and restore clean power to the connected equipment.</p>
	<p>Execute Battery Self Test Use this menu option to conduct a self test and determine the battery status. Press the ENTER button to initiate the test. If the test command is accepted, the Easy-UPS will initiate a self test and will start a count down on the display. Display messages are shown at the end of the test.</p> <p> Test refused. The output is off or battery is not charged.</p> <p> Test not passed</p> <p>Press the MUTE/ESC button to return to the Home Screen.</p>

Configure Easy-UPS parameters

Follow the steps to configure parameters in the Easy-UPS:

1. Press the ENTER button.
2. Press the UP/DOWN ARROW buttons to navigate to “Set”.
3. Press the ENTER button.
4. Navigate through the parameters using the UP/DOWN ARROW buttons.
5. Press the ENTER button to edit a parameter. Icons start flashing to indicate the editing.
6. Press the UP/DOWN ARROW buttons to navigate between the options available for the selected parameter.
7. Press the ENTER button to select the option or MUTE/ESC button to abort the editing of current parameter. Flashing of icons stops after this.
8. Press the UP/DOWN ARROW buttons to navigate between parameters.
9. Press the MUTE/ESC button to exit menu navigation.

Troubleshooting

Use the table below to solve minor installation and operation problems. Refer to the APC by Schneider Electric website, www.apc.com for assistance with complex Easy-UPS problems.

Problem and/or Possible Cause	Solution
Easy-UPS will not turn On when utility input is available or there is no power output	
The Easy-UPS is not turned on.	Press the POWER button to turn on the Easy-UPS.
The Easy-UPS is not connected to utility power supply.	Check that the power cable from the Easy-UPS to the utility power supply is securely connected at both ends.
Input circuit breaker on the Easy-UPS is tripped.	Turn on the circuit breaker in the rear panel. Refer “Rear Panel Features” on page 13 for details.
The Easy-UPS is operating on battery, while connected to the input utility power	
There is high, low, or distorted input voltage or frequency.	Connect the UPS to a different outlet on a different circuit. Test the utility input power to ensure the unit is receiving input power. If display is on, navigate and check the input voltage and frequency.
Easy-UPS, when connected to battery, is not supplying power to the connected equipment	
The Easy-UPS is not turned on.	If the Easy-UPS has shutdown (the display is not on), turn the Easy-UPS on by following the Cold start procedure. Refer “Cold start the Easy-UPS” on page 19 for details.
The battery is not connected.	Connect battery to the Easy-UPS. Refer “Connect the Easy-UPS to a battery system” on page 16 for details.
Low battery cut off. Easy-UPS may have discharged the battery due to utility power outage and turned the output off due to low battery condition.	Wait for the utility power to be restored and charge the battery. To turn on the output power after utility power is restored, press POWER ON button.
Easy-UPS emits an audible beeping sound at long intervals	
The Easy-UPS is operating normally when running on battery.	Easy-UPS has detected an error. Refer “Alerts and Notifications” on page 31 for details.
Alert LED is illuminated. The Easy-UPS displays an alert message and emits a constant beeping sound	
The Easy-UPS has detected an error.	Refer “Alerts and Notifications” on page 31 for details.
No audible sounds from Easy-UPS even when the Alert LED is illuminated	
Audible alert is disabled.	Change the Easy-UPS configuration to enable audible alerts.

Problem and/or Possible Cause	Solution
Easy-UPS is not providing expected backup time	
The Easy-UPS battery is discharged due to a recent power outage.	The batteries require recharging after extended outages. Batteries can wear faster when put into service without proper recharging or when operated at elevated temperatures.
The battery is near the end of its service life.	If the battery is near the end of its service life, consider replacing the battery, even if the replace battery indicator is not illuminated. Refer “Output and Input Hardwire Instructions” on page 14 for details.
Easy-UPS is not turning off	
POWER OFF button not pressed properly.	Press and hold the POWER OFF button until the beep is heard to power off the Easy-UPS.
Utility input power is available.	Easy-UPS logic power cannot be turned off if utility input power is available. To turn off the Easy-UPS, turn off utility input power and press POWER OFF button. Release when a beep is heard.
Easy-UPS is in Bypass mode and the LED is not illuminated red	
Easy-UPS is in green mode.	Disable green mode if not desired.
Easy-UPS is configured to stay in the bypass mode.	Change the configuration to exit bypass mode.
Easy-UPS is in bypass mode even after over temperature alarm is cleared.	Reduce the connected load to < 70% to bring the Easy-UPS to online mode.
The Easy-UPS has experienced an overload condition and transferred to bypass.	Connected equipment exceeds the maximum load as defined in specifications on the APC by Schneider Electric website, www.apc.com . The alerts remain on until the overload condition is corrected. Disconnect nonessential equipment from the Easy-UPS to eliminate the overload condition. The Easy-UPS continues to supply power as long as it is in bypass mode and the circuit breaker does not trip. The Easy-UPS will not provide battery power in the event of a utility voltage interruption.
Easy-UPS detected an error and transferred to bypass.	Refer “Alerts and Notifications” on page 31 for details.

Alerts and Notifications

Alerts

Display code	Description	Solution
SC	Easy-UPS has experienced a short circuit at the output. Unit will try to auto-recover from this condition.	Check if there is any short circuit at the Easy-UPS output. Remove the short circuit and press POWER ON/OFF button to start the Easy-UPS. Note: The power supplied to the connected equipment is dropped when the Easy-UPS is in this condition.
OL	Easy-UPS is experiencing an overload condition.	Disconnect nonessential equipment from the Easy-UPS to eliminate the overload condition.
DLH	The Easy-UPS has detected a DC voltage error. Unit will try to auto-recover from this condition.	If the Easy-UPS does not recover automatically, contact APC by Schneider Electric.
Hot	Temperature of the unit is rising above the set limits.	Disconnect nonessential equipment from the Easy-UPS to reduce the load. Ensure that ambient temperature is within limits. Ensure that adequate clearance is maintained.
CH9	Easy-UPS has detected a charger error.	Verify if there is any short circuit at the Easy-UPS battery terminal. Press POWER ON/OFF button to start the Easy-UPS.
Contact APC by Schneider Electric for all other alert codes.		

Notifications

Display code	Description	Solution
bOL	Battery is not connected.	Connect battery to the Easy-UPS. Refer “Connect the Easy-UPS to a battery system” on page 16 for details.
EPO	EPO enabled.	Set the circuit in closed position to disable EPO function.

Transport

1. Shut down and disconnect all connected equipment.
2. Disconnect the unit from mains power.
3. Disconnect external batteries.

Service

If the unit requires service, do not return it to the dealer. Follow these steps:

1. Review the *Troubleshooting* section of the manual to eliminate common problems.
2. If the problem persists, contact APC by Schneider Electric Customer Support.
 - a. Note the model number and serial number and the date of purchase. The model and serial numbers are located on the rear panel of the unit and are available through the LCD display on select models.
 - b. Call APC by Schneider Electric Customer Support and a technician will attempt to solve the problem over the phone. If this is not possible, the technician will issue a Service Request Number.
 - c. If the unit is under warranty, the repairs are free.

An Authorised Service Representative will visit your location and try to resolve the issue.

Limited Factory Warranty

Schneider Electric IT Business India Private Ltd. (SEITBIPL), warrants its products to be free from defects in materials and workmanship for a period of two (2) years from the date of purchase. The SEITBIPL obligation under this warranty is limited to repairing or replacing, at its own sole option, any such defective products or parts thereof. Repair or replacement of a defective product or part thereof does not extend the original warranty period.

This warranty applies only to the original purchaser who must have properly registered the product within 10 days of purchase. Products may be registered online at warranty.apc.com or by mailing in the completed warranty registration card that is included with the documentation.

SEITBIPL shall not be liable under the warranty if its testing and examination disclose that the alleged defect in the product does not exist or was caused by end user or any third person misuse, negligence, improper installation, testing, operation or use of the product contrary to SEITBIPL recommendations or specifications. Further, SEITBIPL shall not be liable for defects resulting from: 1) unauthorized attempts to repair or modify the product, 2) incorrect or inadequate electrical voltage or connection, 3) inappropriate on site operation conditions, 4) Acts of God, 5) exposure to the elements, 6) theft. In no event shall SEITBIPL have any liability under this warranty for any product where the serial number has been altered, defaced, or removed, 7) normal wear resulting from frequent use.

EXCEPT AS SET FORTH ABOVE, THERE ARE NO WARRANTIES, EXPRESS OR IMPLIED, BY OPERATION OF LAW OR OTHERWISE, APPLICABLE TO PRODUCTS SOLD, SERVICED OR FURNISHED UNDER THIS AGREEMENT OR IN CONNECTION HEREWITH.

SEITBIPL DISCLAIMS ALL IMPLIED WARRANTIES OF MERCHANTABILITY, SATISFACTION AND FITNESS FOR A PARTICULAR PURPOSE.

SEITBIPL EXPRESS WARRANTIES WILL NOT BE ENLARGED, DIMINISHED, OR AFFECTED BY AND NO OBLIGATION OR LIABILITY WILL ARISE OUT OF, SEITBIPL RENDERING OF TECHNICAL OR OTHER ADVICE OR SERVICE IN CONNECTION WITH THE PRODUCTS.

THE FOREGOING WARRANTIES AND REMEDIES ARE EXCLUSIVE AND IN LIEU OF ALL OTHER WARRANTIES AND REMEDIES. THE WARRANTIES SET FORTH ABOVE CONSTITUTE SEITBIPL'S SOLE LIABILITY AND PURCHASER'S EXCLUSIVE REMEDY FOR ANY BREACH OF SUCH WARRANTIES. SEITBIPL WARRANTIES EXTEND ONLY TO ORIGINAL PURCHASER AND ARE NOT EXTENDED TO ANY THIRD PARTIES.

IN NO EVENT SHALL SEITBIPL, ITS OFFICERS, DIRECTORS, AFFILIATES OR EMPLOYEES BE LIABLE FOR ANY FORM OF INDIRECT, SPECIAL, CONSEQUENTIAL OR PUNITIVE DAMAGES, ARISING OUT OF THE USE, SERVICE OR INSTALLATION OF THE PRODUCTS, WHETHER SUCH DAMAGES ARISE IN CONTRACT OR TORT, IRRESPECTIVE OF FAULT, NEGLIGENCE OR STRICT LIABILITY OR WHETHER SEITBIPL HAS BEEN ADVISED IN ADVANCE OF THE POSSIBILITY OF SUCH DAMAGES. SPECIFICALLY, SEITBIPL IS NOT LIABLE FOR ANY COSTS, SUCH AS LOST PROFITS OR REVENUE, WHETHER DIRECT OR INDIRECT, LOSS OF EQUIPMENT, LOSS OF USE OF EQUIPMENT, LOSS OF SOFTWARE, LOSS OF DATA, COSTS OF SUBSTITUANTS, CLAIMS BY THIRD PARTIES, OR OTHERWISE.

To obtain service under warranty you must call customer support. Customers with warranty claims issues may access the SEITBIPL worldwide customer support network through the SEITBIPL Web site: www.apc.com. Select your country from the country selection drop down menu. Open the Support tab at the top of the web page to obtain information for customer support in your region. Refer to the product user manual for more information on how to contact customer support.

APC by Schneider Electric Customer Support

Internet	http://www.apc.com/support
Toll Free	18001030011/18004194272
E-mail	indiainfo@apc.com