

APC[™]

by Schneider Electric

Installation Guide

Smart-UPS[™]

External Battery Pack

SURT192RMXLBP2

SURT192RMXLBP2J

Stack/Rack-Mount 6U

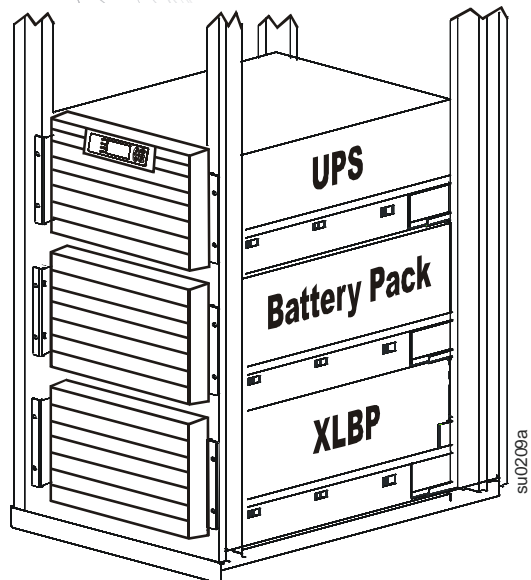
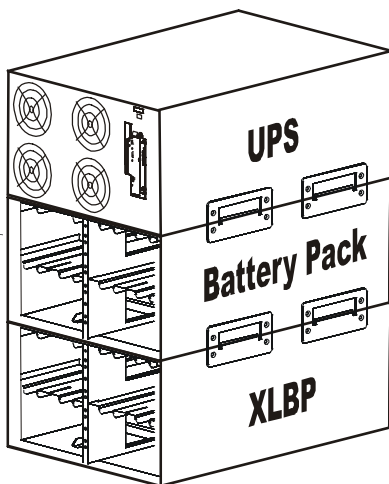

su0209a

Smart-UPSTM RT
External Battery Pack
Stack/Rack-Mount 6U

SURT192RMXLBP2
SURT192RMXLBP2J
English

Introduction

About this UPS

The APC™ by Schneider Electric Smart-UPS™ SURT 192RMLBP2 external battery pack connects to select APC by Schneider Electric Uninterruptible Power Supply (UPS) models. Together these units provide extended protection for electronic equipment from utility power blackouts, brownouts, sags, and surges. The UPS and the external battery pack together provide continuous power from the batteries until utility power returns to safe levels or the batteries are fully discharged.

The UPS and XLBP are packaged separately.

Unpack package contents

Read the Safety Guide before installing the unit.







Inspect the battery pack upon receipt. Notify the carrier and dealer if there is damage.

The packaging is recyclable; save it for reuse or dispose of it properly.

Check the battery pack package contents:

- External battery pack
- Front bezel
- Battery compartment doors
- Ground wire
- Four tie brackets
- Sixteen ornamental screws
- Rail Kit
- Four ornamental screws
- Two cage nuts
- Two rail cleats
- Four pan head screws
- Two rack-mount brackets
- Eight flat head screws
- Literature kit containing:
 - Product documentation
 - Documentation CD
 - Safety information
 - Warranty information

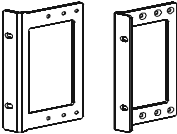
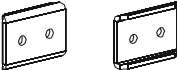
NOTE: The model and serial numbers are located on a small, rear panel label. For some models, an additional label is located on the chassis under the front bezel.

Hardware		
4		Pan head screws for securing rail cleats to unit
8		Flat head screws for securing rack-mount or tie brackets to unit
20		Ornamental screws: • 4 for securing unit to rack • 16 for securing tie brackets in stack configuration
2		Cage nuts used in rack-mount installation
2		Rack-mount brackets
2		Rail cleats
2		Tie brackets for securing units in stack configuration

Accessories

Install accessories prior to connecting power to the UPS.

Refer to the APC by Schneider Electric web site, www.apc.com for available accessories.

Specifications

Environmental Specifications

Temperature	Operating	0° to 40° C (32° to 104° F)	<p>This unit is intended for indoor use only. Select a location sturdy enough to handle the weight.</p> <p>Do not operate unit where there is excessive dust or temperature or humidity are outside specified limits.</p> <p>Environmental factors impact battery life. High temperatures, poor utility power, and frequent, short duration discharges will shorten battery life.</p>
	Storage	-15° to 30° C (5° to 86° F) charge UPS battery every six months 30° to 70° C (86° to 158° F) charge UPS battery every three months	
Maximum Elevation	Operating	3,000 m (10,000 ft)	
	Storage	15,000 m (50,000 ft)	
Humidity		0 to 95% relative humidity, non-condensing	

Physical Specifications

Weight Refer to the Safety Guide supplied with this unit for lifting guidelines.		
Battery Pack	with eight battery modules	181 kg (400 lbs)
	without battery modules	44 kg (96 lbs)
	each battery module	17 kg (38 lbs)
Maximum number of external battery packs (XLBPs)		10 Combined weights of UPS, battery pack and all XLBPs installed in a rack must not exceed rack weight limits.
Dimensions		
Battery Pack	width	482 mm (19 in) with rack-mount brackets 432 mm (17 in) without rack-mount brackets
	height	263 mm (10 in)
	depth	739 mm (29 in) with PDU 720 mm (28 in) without PDU

Installation



Batteries must be removed from battery pack and XLBPs prior to installing units in stack or rack-mount configuration. Refer to instructions on packaging for details on removing batteries from battery pack and XLBPs.

Always place the UPS above the battery pack and XLBPs.

Stack configuration

Total stack configuration height must NOT exceed 18U. The UPS and battery pack together equal 12U. Adding one XLBP creates an 18U configuration.

For detailed instructions on installing batteries, and battery doors, refer to *Rack-mount configuration* in this manual.

Install tie brackets

Four ornamental screws (supplied in battery pack package), must be used to secure each tie bracket to the units.

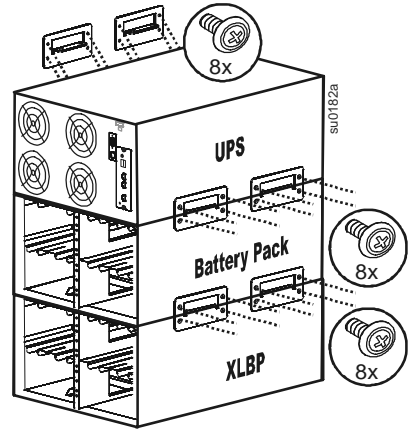

Rack-mount configuration

Read the Safety Guide included in the package and refer to *Physical Specifications* in this manual before installing the UPS.

Install rack-mount brackets

Four flat head screws must be used to secure each rack-mount bracket to unit.

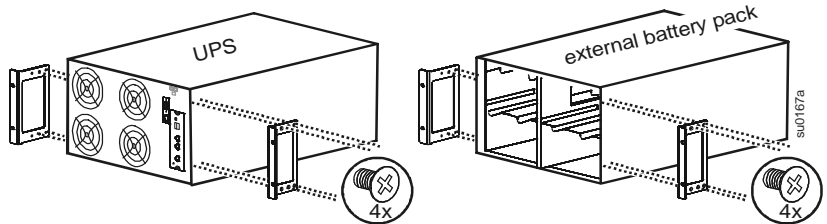

Install rail cleats

Two pan head screws must be used to secure each rail cleat to unit.

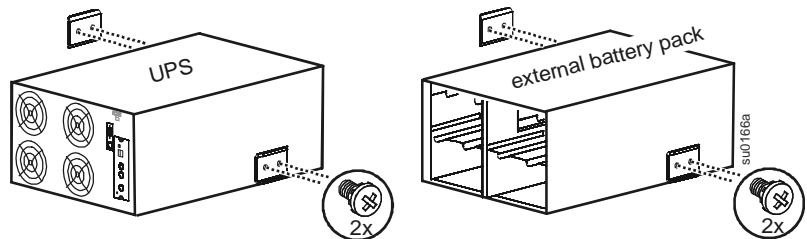

Install rails in rack

For details on rail installation refer to instructions included in rail kit package.

Install units in rack

Secure UPS, battery pack and XLBP in rack using cage nuts and ornamental screws included in package.

Four ornamental screws and two cage nuts must be used to secure each unit.

A cage nut must be used in the top hole of each rack-mount bracket when securing the unit in the rack.

The bottom hole of each rack-mount bracket can be secured using an ornamental screw in the threaded hole.

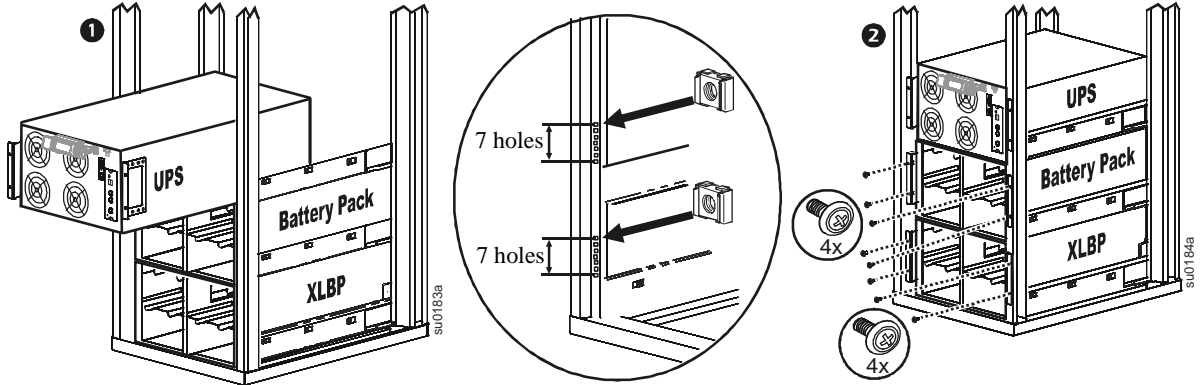

Install and connect battery modules



Connect all eight battery modules. Failure to do so may cause equipment damage.

Replace battery compartment doors. Tighten screws to secure battery compartment doors.

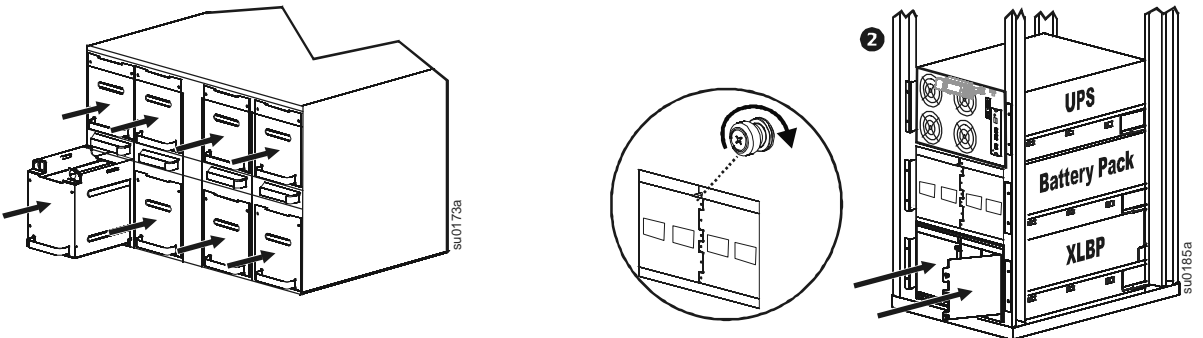

Install bezels

There is a single latch on each side of the UPS bezel.

There are two latches on each side of the battery pack and XLBP bezels.

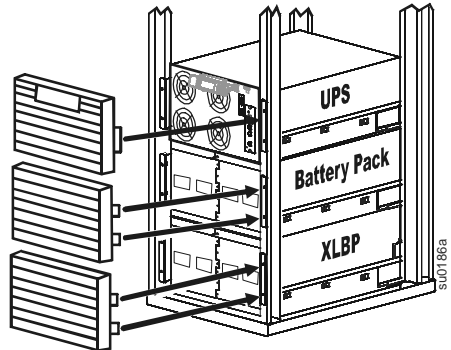

Connect UPS, Battery Pack and XLBP

Units may vary in appearance from those depicted in this manual.

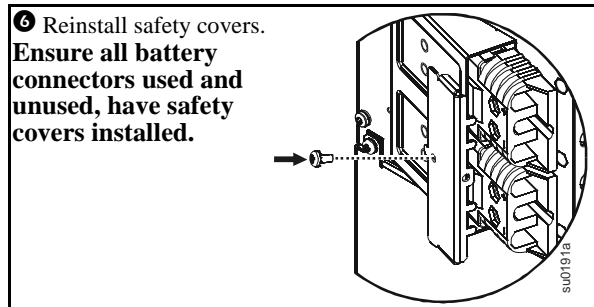
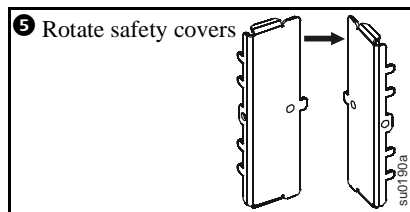
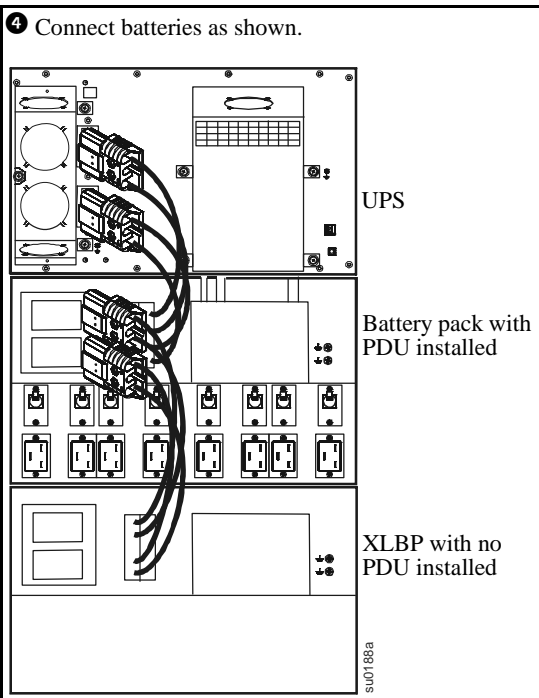
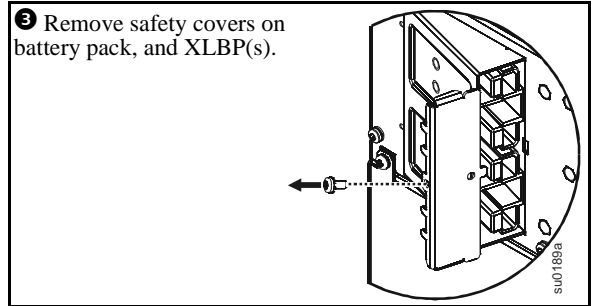
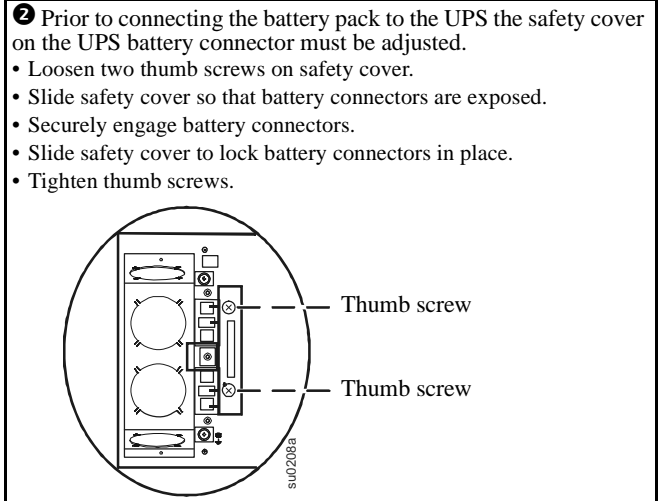
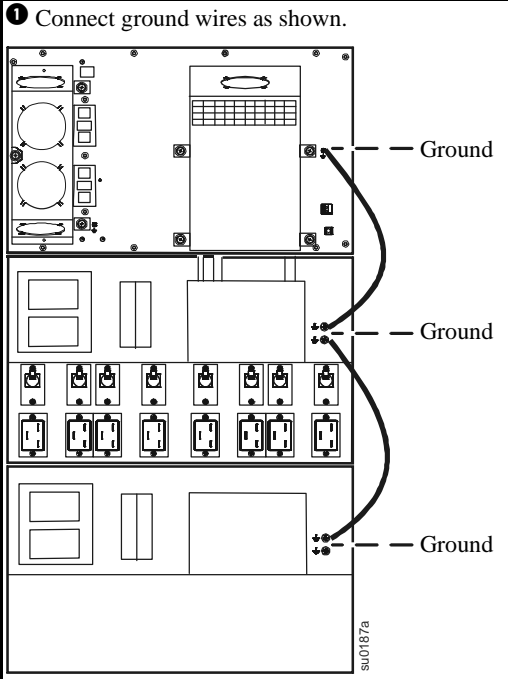

Operation

Battery LED

The battery LED is located on the front bezel of the XLBP. During normal operation the LED is not illuminated.

On start-up the XLBP LED will illuminate and blink within the first minute. The LED should then extinguish.

If the LED remains illuminated perform the following steps to extinguish the LED.

1. Allow unit to run for two continuous hours without removing or installing batteries.
2. Verify that display interface shows actual number of XLBPs connected.
3. Verify that display interface shows **CHRG** (battery charge), is greater the 95%.
4. Verify that display interface shows **Load** is greater than 5% x the number of external battery packs installed.
5. Verify that display interface shows **Runtime** is greater than 00hr3.3m.
6. Perform a self-test as described in Smart-UPS user manual.

If the LED remains illuminated after performing these steps, refer to the troubleshooting table below.

LED Activity	Possible Cause	Corrective Action after a Self-Test is Performed
XLBP LED illuminates briefly		
<ul style="list-style-type: none">• On start up the XLBP LED will illuminate and blink within the first minute.• The XLBP is establishing communication with other components of the system.• The XLBP is conducting a normal periodic self test	Normal operation	No action is necessary.
XLBP LED remains illuminated NOTE: Read the information and perform steps outlined in the list above prior to performing the actions listed in this table.		
XLBP LED is blinking slowly (one blink per second).	One or more battery modules are not connected.	<ul style="list-style-type: none">• Check that all battery connections in the UPS/XLBP configuration are secure.• Replace battery modules.
XLBP LED is flashing rapidly (three flashes per second).	A communication fault exists, check cable connections.	<ul style="list-style-type: none">• Check that all cable and battery connections in the UPS/XLBP configuration are secure.• Testing beyond the self-test may be required. Contact APC by Schneider Electric. Refer to <i>Service</i> in this manual.
The XLBP LED remains illuminated.	A potential hardware fault exists.	Contact APC by Schneider Electric, refer to <i>Service</i> in this manual.
XLBP LED does not illuminate		
On start up the XLBP LED does not illuminate	Normal operation.	No action is necessary.

Battery module and pair identification

The display interface will reference XLBP configuration in the following manner.

External Battery Pack			
Negative BattPair 1		Positive BattPair 2	
Module 1	Module 2	Module 3	Module 4
Negative BattPair 3		Positive BattPair 4	
Module 5	Module 6	Module 7	Module 8

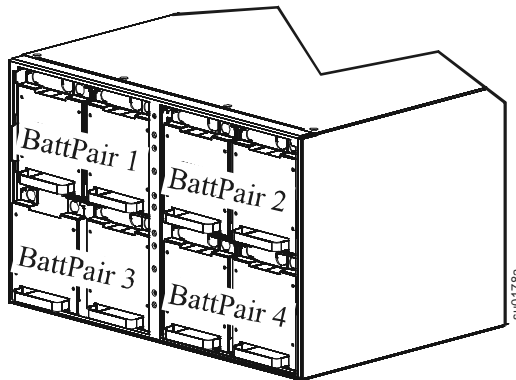

Maintenance, Transport, and Service

Replace battery modules

This UPS has easy to replace, hot swappable battery modules. Replacement is a safe procedure, isolated from electrical hazards. You may leave the UPS and connected equipment on during the replacement procedure.

Once the batteries are disconnected the connected equipment is not protected from power outages.

Refer to the appropriate replacement battery user manual for battery module installation instructions. See your dealer or contact APC by Schneider Electric at www.apc.com for information on replacement battery modules.



Be sure to deliver the spent battery(s) to a recycling facility or ship it to APC in the replacement battery packing material.

Transport

1. Shut down and disconnect all connected equipment.
2. Disconnect the unit from utility power.
3. Disconnect all internal and external batteries (if applicable).
4. Follow the shipping instructions outlined in the *Service* section of this manual.

Service

If the unit requires service, do not return it to the dealer. Follow these steps:

1. Review the *Troubleshooting* section of the manual to eliminate common problems.
2. If the problem persists, contact APC by Schneider Electric Customer Support through the APC by Schneider Electric web site, www.apc.com.
 - a. Note the model number and serial number and the date of purchase. The model and serial numbers are located on the rear panel of the unit and are available through the LCD display on select models.
 - b. Call Customer Support and a technician will attempt to solve the problem over the phone. If this is not possible, the technician will issue a Returned Material Authorization Number (RMA#).
 - c. If the unit is under warranty, the repairs are free.
 - d. Service procedures and returns may vary internationally. Refer to the APC by Schneider Electric web site, www.apc.com for country specific instructions.
3. Pack the unit properly to avoid damage in transit. Never use foam beads for packaging. Damage sustained in transit is not covered under warranty.
 - a. **Note: When shipping within the United States, or to the United States always DISCONNECT ONE UPS BATTERY before shipping in compliance with U.S. Department of Transportation (DOT) and IATA regulations.** The internal batteries may remain in the UPS.
 - b. Batteries may remain connected in the XBP during shipment. Not all units utilize XLBPs.
4. Write the RMA# provided by Customer Support on the outside of the package.
5. Return the unit by insured, prepaid carrier to the address provided by Customer Support.

Limited Factory Warranty

Schneider Electric IT Corporation (SEIT), warrants its products to be free from defects in materials and workmanship for a period of two (2) years from the date of purchase. The SEIT obligation under this warranty is limited to repairing or replacing, at its own sole option, any such defective products. Repair or replacement of a defective product or parts thereof does not extend the original warranty period.

This warranty applies only to the original purchaser who must have properly registered the product within 10 days of purchase. Products may be registered online at warranty.apc.com.

SEIT shall not be liable under the warranty if its testing and examination disclose that the alleged defect in the product does not exist or was caused by end user or any third person misuse, negligence, improper installation, testing, operation or use of the product contrary to SEIT recommendations or specifications. Further, SEIT shall not be liable for defects resulting from: 1) unauthorized attempts to repair or modify the product, 2) incorrect or inadequate electrical voltage or connection, 3) inappropriate on site operation conditions, 4) Acts of God, 5) exposure to the elements, or 6) theft. In no event shall SEIT have any liability under this warranty for any product where the serial number has been altered, defaced, or removed.

EXCEPT AS SET FORTH ABOVE, THERE ARE NO WARRANTIES, EXPRESS OR IMPLIED, BY OPERATION OF LAW OR OTHERWISE, APPLICABLE TO PRODUCTS SOLD, SERVICED OR FURNISHED UNDER THIS AGREEMENT OR IN CONNECTION HEREWITH.

SEIT DISCLAIMS ALL IMPLIED WARRANTIES OF MERCHANTABILITY, SATISFACTION AND FITNESS FOR A PARTICULAR PURPOSE.

SEIT EXPRESS WARRANTIES WILL NOT BE ENLARGED, DIMINISHED, OR AFFECTED BY AND NO OBLIGATION OR LIABILITY WILL ARISE OUT OF, SEIT RENDERING OF TECHNICAL OR OTHER ADVICE OR SERVICE IN CONNECTION WITH THE PRODUCTS.

THE FOREGOING WARRANTIES AND REMEDIES ARE EXCLUSIVE AND IN LIEU OF ALL OTHER WARRANTIES AND REMEDIES. THE WARRANTIES SET FORTH ABOVE CONSTITUTE SEIT SOLE LIABILITY AND PURCHASER EXCLUSIVE REMEDY FOR ANY BREACH OF SUCH WARRANTIES. SEIT WARRANTIES EXTEND ONLY TO ORIGINAL PURCHASER AND ARE NOT EXTENDED TO ANY THIRD PARTIES.

IN NO EVENT SHALL SEIT, ITS OFFICERS, DIRECTORS, AFFILIATES OR EMPLOYEES BE LIABLE FOR ANY FORM OF INDIRECT, SPECIAL, CONSEQUENTIAL OR PUNITIVE DAMAGES, ARISING OUT OF THE USE, SERVICE OR INSTALLATION OF THE PRODUCTS, WHETHER SUCH DAMAGES ARISE IN CONTRACT OR TORT, IRRESPECTIVE OF FAULT, NEGLIGENCE OR STRICT LIABILITY OR WHETHER SEIT HAS BEEN ADVISED IN ADVANCE OF THE POSSIBILITY OF SUCH DAMAGES. SPECIFICALLY, SEIT IS NOT LIABLE FOR ANY COSTS, SUCH AS LOST PROFITS OR REVENUE, WHETHER DIRECT OR INDIRECT, LOSS OF EQUIPMENT, LOSS OF USE OF EQUIPMENT, LOSS OF SOFTWARE, LOSS OF DATA, COSTS OF SUBSTITUANTS, CLAIMS BY THIRD PARTIES, OR OTHERWISE.

NOTHING IN THIS LIMITED WARRANTY SHALL SEEK TO EXCLUDE OR LIMIT SEIT LIABILITY FOR DEATH OR PERSONAL INJURY RESULTING FROM ITS NEGLIGENCE OR ITS FRAUDULENT MISREPRESENTATION OF TO THE EXTENT THAT IT CANNOT BE EXCLUDED OR LIMITED BY APPLICABLE LAW.

To obtain service under warranty you must obtain a Returned Material Authorization (RMA) number from customer support. Customers with warranty claims issues may access the SEIT worldwide customer support network through the APC web site: www.apc.com. Select your country from the country selection drop down menu. Open the Support tab at the top of the web page to obtain information for customer support in your region. Products must be returned with transportation charges prepaid and must be accompanied by a brief description of the problem encountered and proof of date and place of purchase.

APC by Schneider Electric Worldwide Customer Support

Customer support for this or any other APC by Schneider Electric product is available at no charge in any of the following ways:

- Visit the APC by Schneider Electric web site, www.apc.com to access documents in the APC Knowledge Base and to submit customer support requests.
 - **www.apc.com** (Corporate Headquarters)
Connect to localized APC by Schneider Electric web site for specific countries, each of which provides customer support information.
 - **www.apc.com/support/**
Global support searching APC Knowledge Base and using e-support.
- Contact the APC by Schneider Electric Customer Support Center by telephone or e-mail.
 - Local, country specific centers: go to **www.apc.com/support/contact** for contact information.
 - For information on how to obtain local customer support, contact the APC by Schneider Electric representative or other distributor from whom you purchased your APC by Schneider Electric product.

© 2014 APC by Schneider Electric. Smart-UPS and PowerChute are owned by Schneider Electric Industries S.A.S. or their affiliated companies. All other trademarks are property of their respective owners.