



by Schneider Electric

User Manual

Smart-UPSTM

Uninterruptible Power Supply

1000/1500 VA
100/120/230 Vac

750XL/1000XL VA
120/230 Vac

Tower

Smart-UPS™

Uninterruptible Power Supply

**1000/1500 VA
100/120/230 Vac**

**750XL/1000XL VA
120/230 Vac**

Tower

English

Introduction

The APC™ by Schneider Electric Smart-UPS™ is a high performance uninterruptible power supply (UPS). The UPS provides protection for electronic equipment from utility power blackouts, brownouts, sags, surges, small utility power fluctuations and large disturbances. The UPS also provides battery backup power for connected equipment until utility power returns to safe levels or the batteries are fully discharged.

This user manual is available on the enclosed CD and on the APC by Schneider Electric web site, www.apc.com.

1: INSTALLATION

Read the Safety Instruction sheet before installing the UPS.

Unpacking

Inspect the UPS upon receipt. APC by Schneider Electric designed robust packaging for your product. However, accidents and damage may occur during shipment. Notify the carrier and dealer if there is damage.

The packaging is recyclable; save it for reuse or dispose of it properly.

Check the package contents. The package contains the UPS, a literature kit containing one CD, one serial cable, one USB cable, product documentation and Safety Information.

230V models: Two IEC jumper cables are included for use on servers with permanently attached power cords.

The UPS is shipped with the battery disconnected.

Positioning the UPS

The UPS is heavy. Select a location sturdy enough to handle the weight.

Do not operate the UPS where there is excessive dust or the temperature and humidity are outside the specified limits.

PLACEMENT

0°- 40°C (32°-104°F)

0-95% Relative Humidity

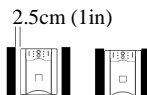

Connecting Equipment and Power to the UPS

SMART-UPS REAR PANEL

230V MODELS

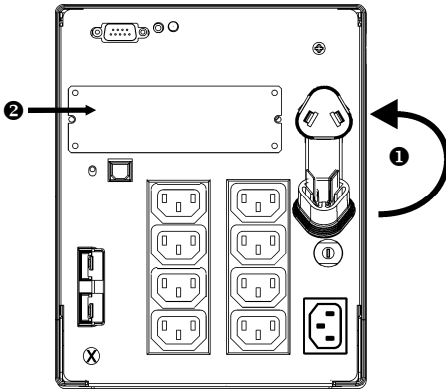

120V/100V MODELS

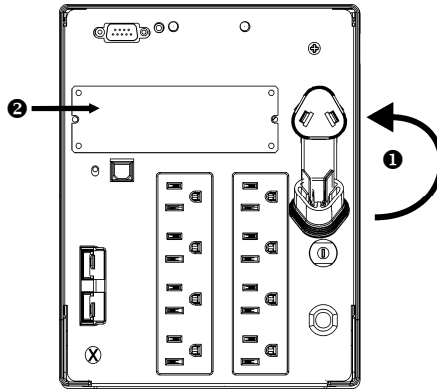

1. **Plug in the battery connector ❶.**
2. Connect equipment to the UPS. **Note: Do not connect a laser printer to the UPS. A laser printer draws significantly more power than other types of equipment and may overload the UPS.**
3. Add any optional accessories to the SmartSlot ❷.
4. Using the power cord, plug the UPS into a two pole, three wire, grounded receptacle only. Avoid using extension cords.
 - *120V/100V models:* The power cord is permanently attached to the rear panel of the UPS.
5. Turn on all connected equipment. To use the UPS as a master ON/OFF switch, be sure all connected equipment is switched ON. The equipment will not be powered until the UPS is turned on.
6. To power up the UPS press the  button on the front panel.
 - The UPS charges its battery when it is connected to utility power. The battery charges to 90% capacity during the first three hours of normal operation. **Do not** expect full battery run capability during this initial charge period.
 - *120V Models:* Check the site wiring fault LED located on the rear panel. It lights up if the UPS is plugged into an improperly wired utility power outlet. Refer to *Troubleshooting* in this manual.
7. For additional computer system security, install PowerChute™ UPS Power Management and Diagnostic Software.

BASIC CONNECTORS

Serial Port



USB Port



Power management software and interface kits can be used with the UPS. **Use only interface kits supplied or approved by APC by Schneider Electric.**



Use the APC by Schneider Electric supplied cable to connect to the Serial Port. DO NOT use a standard serial interface cable since it is incompatible with the UPS connector.

Both Serial and USB Ports are provided. They cannot be used simultaneously.

External Battery Pack Connector



XL models: Use the battery pack connector to connect optional external battery pack(s). These units support up to ten external battery packs.

See the APC by Schneider Electric web site, www.apc.com/support for the correct external battery pack model number for your UPS.

Note: UPS only supports Sealed Maintenance-Free (SMF) batteries.

TVSS Screw



The UPS features a transient voltage surge-suppression (TVSS) screw for connecting the ground lead on surge suppression devices such as telephone and network line protectors.

When connecting grounding cable, disconnect the unit from the utility power outlet.

2: OPERATION

SMART-UPS FRONT PANEL

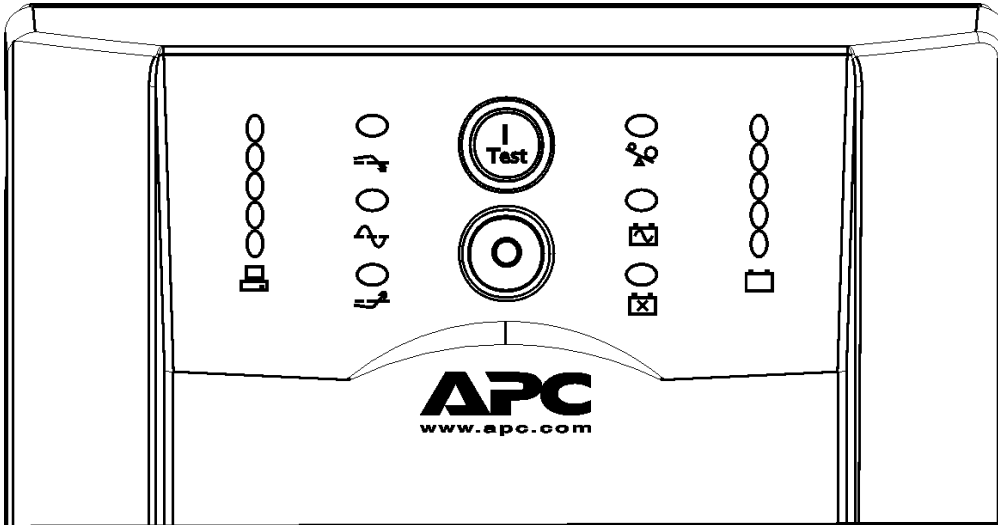
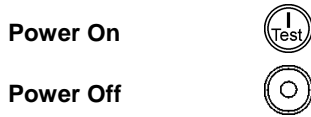

Load

120V	230V/100V
084%	084%
067%	067%
050%	050%
033%	033%
016%	016%

Load



Battery Charge

120V	230V/100V
096%	096%
072%	072%
048%	048%
024%	024%
00%	00%

Battery Charge



Online



The online LED illuminates when the UPS is supplying utility power to the connected equipment. If the LED is not lit, the UPS is either not turned ON, or is supplying battery power.

AVR Trim



This LED illuminates to indicate the UPS is compensating for a high utility voltage.

AVR Boost

This LED illuminates to indicate the UPS is compensating for a low utility voltage.

On Battery

When the *on battery power* LED is lit the UPS is supplying battery power to the connected equipment. When on battery, the UPS sounds an alarm—four beeps every 30 seconds.

Overload

The LED illuminates and the UPS emits a sustained alarm tone when an overload condition occurs.

Replace Battery

Failure of a battery self-test causes the UPS to emit short beeps for one minute and the *replace battery* LED illuminates. Refer to *Troubleshooting* in this manual.

Battery Disconnected

The *replace battery* LED flashes and short beep is emitted every two seconds to indicate the battery is disconnected.

Automatic Self-Test

The UPS performs a self-test automatically when turned on, and every two weeks thereafter (by default).

During the self-test, the UPS briefly operates the connected equipment on battery.

If the UPS fails the self-test, the *replace battery* LED  lights and immediately returns to online operation. The connected equipment is not affected by a failed test. Recharge the battery for 24 hours and perform another self-test. If it fails, the battery must be replaced.

Manual Self-Test

Press and hold the  button for a few seconds to initiate the self-test.

On Battery Operation

The Smart-UPS switches to battery operation automatically if the utility power fails. While running on battery, an alarm beeps four times every 30 seconds.

Press the  button (front panel) to silence the UPS alarm (for the current alarm only). If the utility power does not return, the UPS continues to supply power to the connected equipment until the battery is exhausted.





If PowerChute is not being used you must manually save your files and power down before the UPS turns off.





Determining On Battery Run Time

UPS battery life differs based on usage and environment. It is recommended that the battery/batteries be changed once every three years. See the APC by Schneider Electric web site, www.apc.com, for on battery run times.

3: USER CONFIGURABLE ITEMS

NOTE: SETTINGS ARE MADE THROUGH SUPPLIED POWERCHUTE SOFTWARE OR OPTIONAL SMARTSLOT ACCESSORY CARDS.

<i>FUNCTION</i>	<i>FACTORY DEFAULT</i>	<i>USER SELECTABLE CHOICES</i>	<i>DESCRIPTION</i>
Automatic Self-Test	Every 14 days (336 hours)	Every 7 days (168 hours) On Startup Only No Self-Test	This function sets the interval at which the UPS will execute a self-test. Refer to your software manual for details.
UPS ID	UPS_IDEN	Up to eight characters to define the UPS	Use this field to uniquely identify the UPS, (ie. server name or location) for network management purposes.
Date of Last Battery Replacement	Manufacture Date	Date of Battery Replacement mm/dd/yy	Reset this date when you replace the battery module.
Minimum Capacity Before Return from Shutdown	0 percent	15, 30, 45, 50, 60, 75, 90 percent	The UPS will charge its batteries to the specified percentage before return from a shutdown.
Voltage Sensitivity The UPS detects and reacts to line voltage distortions by transferring to battery operation to protect the connected equipment. Where power quality is poor, the UPS may frequently transfer to battery operation. If the connected equipment can operate normally under such conditions, reduce the sensitivity setting to conserve battery capacity and service life.	 high  medium  low	Brightly lit: UPS is set to <i>high</i> sensitivity (default). Dimly lit: UPS is set to <i>medium</i> sensitivity. Off: Low battery warning interval is about eight minutes.	To change the UPS sensitivity, press the <i>voltage sensitivity</i> button  (rear panel). Use a pointed object (such as a pen) to do so. You can change the sensitivity level through PowerChute software.
Alarm Control	Enable	Mute, Disable	User can mute an ongoing alarm or disable all existing alarms permanently.
Shutdown Delay	90 seconds	0, 180, 270, 360, 450, 540, 630 seconds	Sets the interval between the time when the UPS receives a shutdown command and actual shutdown.

NOTE: SETTINGS ARE MADE THROUGH SUPPLIED POWERCHUTE SOFTWARE OR OPTIONAL SMARTSLOT ACCESSORY CARDS.			
FUNCTION	FACTORY DEFAULT	USER SELECTABLE CHOICES	DESCRIPTION
Low Battery Warning. PowerChute interface software provides automatic, unattended shutdown when approximately two minutes (by default) of battery operated run time remains.	 2 min.  5 min.  8 min.	<i>Brightly lit:</i> Low battery warning interval is about two minutes. <i>Dimly lit:</i> Low battery warning interval is about five minutes. <i>Off:</i> Low battery warning interval is about eight minutes. Possible interval settings: 2, 5, 8, 11, 14, 17, 20, 23 minutes.	The low battery warning beeps are continuous when two minutes of run time remain. To change the warning interval default setting, press the <i>voltage sensitivity</i> button (use a pointed object such as a pen to do so), while pressing and holding the  button (front panel).
Synchronized Turn-on Delay	0 seconds	60, 120, 180, 240, 300, 360, 420 seconds	The UPS will wait the specified time after the return of utility power before turn on (to avoid branch circuit overload).
High Transfer Point	<i>230 V models:</i> 253 Vac <i>120 V models:</i> 127 Vac <i>100 V models:</i> 108 Vac	<i>230 V models:</i> 257, 261, 265 Vac <i>120 V models:</i> 130, 133, 136 Vac <i>100 V models:</i> 110, 112, 114 Vac	To avoid unnecessary battery usage, set the high transfer point higher if the utility voltage is chronically high and the connected equipment is known to work under this condition.
Low Transfer Point	<i>230V models:</i> 208Vac <i>120V models:</i> 106Vac <i>100V models:</i> 92Vac	<i>230V models:</i> 196, 200, 204Vac <i>120V models:</i> 97, 100, 103Vac <i>100V models:</i> 86, 88, 90Vac	Set the low transfer point lower if the utility voltage is chronically low and connected equipment can tolerate this condition.
Output Voltage	<i>230V models:</i> 230Vac	<i>230V models:</i> 220, 240Vac	<i>230V models ONLY</i> , allow the user to select the output voltage.

4: STORAGE, AND MAINTENANCE

Storage

Store the UPS covered and positioned as for proper functioning, in a cool, dry location, with the batteries fully charged.

At -15° to +30° C (+5° to +86° F), charge the UPS battery every six months.

At +30° to +45° C (+86° to +113° F), charge the UPS battery every three months.

Replace the Battery Module

This UPS has an easy to replace, hot swappable battery module. Replacement is a safe procedure, isolated from electrical hazards. You may leave the UPS and connected equipment on for this procedure. See your dealer or contact APC by Schneider Electric at the web site, www.apc.com/support for information on replacement battery modules.



Once the battery is disconnected, the connected equipment is not protected from power outages.

Be careful during the following steps, the battery module is heavy.

To replace the battery module, reverse the directions for Remove the Front Bezel and Battery Module.

REMOVING THE FRONT BEZEL AND BATTERY MODULE

Step 1

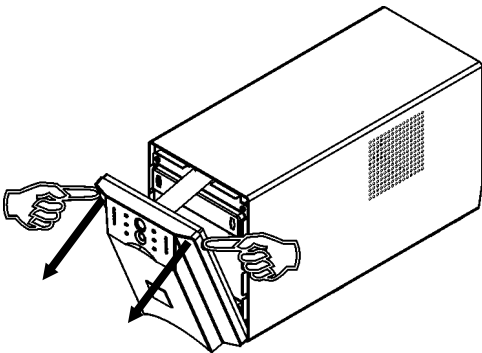

Step 2

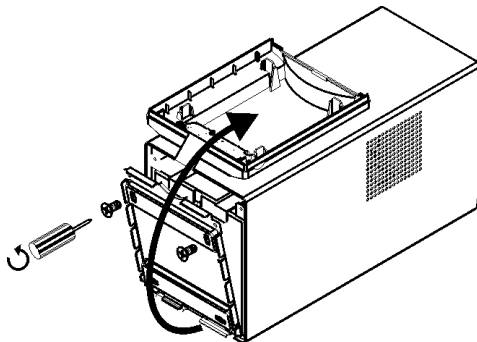

1500VA Model

Step 3

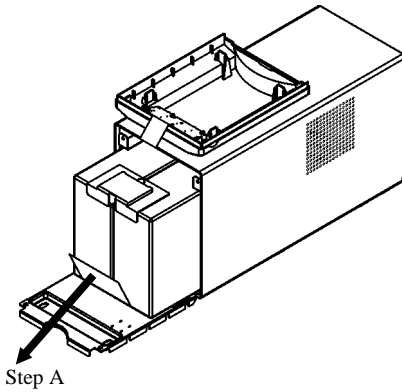

Pull the battery module out of the compartment until the back of the module is flush with the outer edges of the UPS.

Disconnect the battery connector.

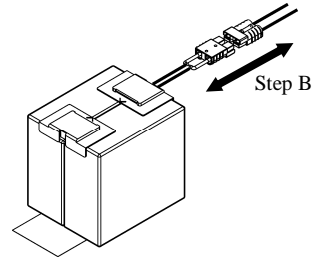

1000VA Model

Step 3

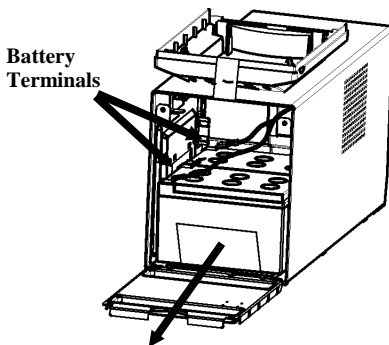

Disconnect the battery cable terminals before removing the battery module from the UPS.

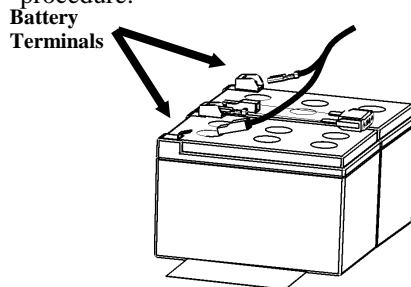

Note: The red cable connects to the red color coded terminal; the black cable connects to the black color coded terminal. This will be important during the battery replacement procedure.









Be sure to deliver the used battery to a recycling facility or ship it to APC by Schneider Electric in the replacement battery packing material.

5: TROUBLESHOOTING

Use the chart below to solve minor Smart-UPS installation and operation problems. Refer to the APC by Schneider Electric web site, www.apc.com, for assistance with complex UPS problems.

PROBLEM AND POSSIBLE CAUSE	SOLUTION
UPS WILL NOT TURN ON	
<p>Battery not connected properly.</p> <p> button not pushed.</p> <p>UPS not connected to utility power supply.</p> <p>Very low or no utility voltage.</p>	<p></p> <p>Check that the battery connector (rear panel) is fully engaged.</p> <p>Press the  button once to power the UPS and the connected equipment.</p> <p>Check that the power cable from the UPS to the utility power supply is securely connected at both ends.</p> <p>Check the utility power supply to the UPS by plugging in a table lamp. If the light is very dim, have the utility voltage checked.</p>
UPS WILL NOT TURN OFF	
Internal UPS fault.	Do not attempt to use the UPS. Unplug the UPS and have it serviced immediately.
UPS BEEPS OCCASIONALLY	
Normal UPS operation.	None. The UPS is protecting the connected equipment.
UPS DOES NOT PROVIDE EXPECTED BACKUP TIME	
The UPS battery is weak due to a recent outage or is near the end of its service life.	Charge the battery. Batteries require recharging after extended outages. They wear faster when put into service often or when operated at elevated temperatures. If the battery is near the end of its service life, consider replacing the battery even if the <i>replace battery</i> LED is not yet lit.
ALL LEDs ARE LIT AND THE UPS EMITS A CONSTANT BEEPING	
Internal UPS fault.	Do not attempt to use the UPS. Turn the UPS off and have it serviced immediately.
FRONT PANEL LEDs FLASH SEQUENTIALLY	
The UPS has been shut down remotely through software or an optional accessory card.	None. The UPS will restart automatically when utility power returns.
ALL LEDs ARE OFF AND THE UPS IS PLUGGED INTO A WALL OUTLET	
The UPS is shut down and the battery is discharged from an extended outage.	None. The UPS will return to normal operation when the power is restored and the battery has a sufficient charge.

PROBLEM AND POSSIBLE CAUSE	SOLUTION
THE OVERLOAD LED IS LIT AND THE UPS EMITS A SUSTAINED ALARM TONE	
<p>The UPS is overloaded.</p>	<p>The connected equipment exceeds the specified “maximum load” as defined in <i>Specifications</i> at the APC by Schneider Electric web site, www.apc.com.</p> <p>The alarm remains on until the overload is removed. Disconnect nonessential equipment from the UPS to eliminate the overload.</p> <p>The UPS continues to supply power as long as it is online and the circuit breaker does not trip; the UPS will not provide power from batteries in the event of a utility voltage interruption.</p> <p>If a continuous overload occurs while the UPS is on battery, the unit turns off output in order to protect the UPS from possible damage.</p>
THE REPLACE BATTERY LED IS LIT	
<p>Replace Battery LED flashes and short beep is emitted every two seconds to indicate the battery is disconnected.</p> <p>Weak battery.</p> <p>Failure of a battery self-test.</p>	<p>Check that the battery connectors are fully engaged.</p> <p>Allow the battery to recharge for 24 hours. Then, perform a self-test. If the problem persists after recharging, replace the battery.</p> <p>The UPS emits short beeps for one minute and the <i>replace battery</i> LED illuminates. The UPS repeats the alarm every five hours. Perform the self-test procedure after the battery has charged for 24 hours to confirm the <i>replace battery</i> condition. The alarm stops and the LED clears if the battery passes the self-test.</p>
THE SITE WIRING FAULT LED IS LIT	
<p>The site wiring LED is lit  (rear panel). <i>120V models only.</i></p>	<p>The UPS is plugged into an improperly wired utility power outlet. Wiring faults detected include missing ground, hot neutral polarity reversal, and overloaded neutral circuit. Contact a qualified electrician to correct the building wiring.</p>
THE INPUT CIRCUIT BREAKER TRIPS	
<p>The plunger on the circuit breaker (located above the input cable connection) pops out.</p> 	<p>Reduce the load on the UPS by unplugging equipment and press the plunger in.</p>
AVR BOOST OR AVR TRIM LEDs LIGHT	
<p>AVR Boost or Trim LEDs light Your system is experiencing excessive periods of low or high voltage.</p>	<p>Have qualified service personnel check your facility for electrical problems. If the problem continues, contact the utility company for further assistance.</p>

PROBLEM AND POSSIBLE CAUSE	SOLUTION																		
UTILITY CIRCUIT BREAKER TRIPS																			
Utility circuit breaker trips during normal operation.	<i>100V models:</i> In order to operate at the full VA rating of the 1500VA product, the supplied 15A plug must be replaced with a 20A plug. This change must be performed by qualified service personnel.																		
UPS OPERATES ON BATTERY ALTHOUGH NORMAL LINE VOLTAGE EXISTS																			
UPS input circuit breaker tripped. Very high, low, or distorted line voltage. Inexpensive fuel powered generators can distort the voltage.	Reduce the load on the UPS by unplugging equipment and resetting the circuit breaker (on the back of UPS) by pressing the plunger in. Move the UPS to a different outlet on a different circuit. Test the input voltage with the utility voltage display (see below). If acceptable to the connected equipment, reduce the UPS sensitivity.																		
BATTERY CHARGE AND BATTERY LOAD LEDs FLASH SIMULTANEOUSLY																			
UPS has shutdown. The internal temperature of the UPS has exceeded the allowable threshold for safe operation.	Check that the room temperature is within the specified limits for operation. Check that the UPS is properly installed allowing for adequate ventilation. Allow the UPS to cool down. Restart the UPS. If the problem continues contact APC by Schneider Electric at, www.apc.com/supoport .																		
DIAGNOSTIC UTILITY VOLTAGE FEATURE																			
<p>Utility Voltage</p> <table border="0"> <tr> <td>230V</td> <td>120V</td> <td>100V</td> </tr> <tr> <td>0266</td> <td>0133</td> <td>0119</td> </tr> <tr> <td>0248</td> <td>0123</td> <td>0109</td> </tr> <tr> <td>0229</td> <td>0115</td> <td>0100</td> </tr> <tr> <td>0210</td> <td>0105</td> <td>091</td> </tr> <tr> <td>0191</td> <td>098</td> <td>081</td> </tr> </table> <p> Battery Charge </p>	230V	120V	100V	0266	0133	0119	0248	0123	0109	0229	0115	0100	0210	0105	091	0191	098	081	<p>The UPS has a diagnostic feature that displays the utility voltage. Plug the UPS into the normal utility power.</p> <p>Press and hold the  button to view the utility voltage bar graph display. After a few seconds the five-LED, Battery Charge, , display on the right of the front panel shows the utility input voltage.</p> <p>Refer to the figure at left for the voltage reading (values are not listed on the UPS).</p> <p>The display indicates the voltage is between the displayed value on the list and the next higher value.</p> <p>Three LEDs light, indicating utility voltage within the normal range.</p> <p>If no LEDs are lit and the UPS is plugged into a working utility power outlet, the line voltage is extremely low.</p> <p>If all five LEDs are lit, the line voltage is extremely high and should be checked by an electrician.</p>
230V	120V	100V																	
0266	0133	0119																	
0248	0123	0109																	
0229	0115	0100																	
0210	0105	091																	
0191	098	081																	
	The UPS starts a self-test as part of this procedure. The self-test does not affect the voltage display.																		

6: TRANSPORT AND SERVICE

Transport

1. Shut down and disconnect all connected equipment.
2. Disconnect the unit from utility power.
3. Disconnect all internal and external batteries (if applicable).
4. Follow the shipping instructions outlined in the *Service* section of this manual.

Service

If the unit requires service, do not return it to the dealer. Follow these steps:

1. Review the *Troubleshooting* section of the manual to eliminate common problems.
2. If the problem persists, contact APC by Schneider Electric Customer Support through the APC by Schneider Electric web site, **www.apc.com**.
 - a. Note the model number and serial number and the date of purchase. The model and serial numbers are located on the rear panel of the unit and are available through the LCD display on select models.
 - b. Call Customer Support and a technician will attempt to solve the problem over the phone. If this is not possible, the technician will issue a Returned Material Authorization Number (RMA#).
 - c. If the unit is under warranty, the repairs are free.
 - d. Service procedures and returns may vary internationally. Refer to the APC by Schneider Electric web site, **www.apc.com** for country specific instructions.
3. Pack the unit properly to avoid damage in transit. Never use foam beads for packaging. Damage sustained in transit is not covered under warranty.
 - a. **Note: When shipping within the United States, or to the United States always DISCONNECT ONE UPS BATTERY before shipping in compliance with U.S. Department of Transportation (DOT) and IATA regulations.** The internal batteries may remain in the UPS.
 - b. Batteries may remain connected in the XBP during shipment. Not all units utilize XLBPs.
4. Write the RMA# provided by Customer Support on the outside of the package.
5. Return the unit by insured, prepaid carrier to the address provided by Customer Support.

7: LIMITED FACTORY WARRANTY

Schneider Electric IT Corporation (SEIT), warrants its products to be free from defects in materials and workmanship for a period of two (2) years from the date of purchase. The SEIT obligation under this warranty is limited to repairing or replacing, at its own sole option, any such defective products. Repair or replacement of a defective product or parts thereof does not extend the original warranty period.

This warranty applies only to the original purchaser who must have properly registered the product within 10 days of purchase. Products may be registered online at warranty.apc.com.

SEIT shall not be liable under the warranty if its testing and examination disclose that the alleged defect in the product does not exist or was caused by end user or any third person misuse, negligence, improper installation, testing, operation or use of the product contrary to SEIT recommendations or specifications. Further, SEIT shall not be liable for defects resulting from: 1) unauthorized attempts to repair or modify the product, 2) incorrect or inadequate electrical voltage or connection, 3) inappropriate on site operation conditions, 4) Acts of God, 5) exposure to the elements, or 6) theft. In no event shall SEIT have any liability under this warranty for any product where the serial number has been altered, defaced, or removed.

EXCEPT AS SET FORTH ABOVE, THERE ARE NO WARRANTIES, EXPRESS OR IMPLIED, BY OPERATION OF LAW OR OTHERWISE, APPLICABLE TO PRODUCTS SOLD, SERVICED OR FURNISHED UNDER THIS AGREEMENT OR IN CONNECTION HEREWITH.

SEIT DISCLAIMS ALL IMPLIED WARRANTIES OF MERCHANTABILITY, SATISFACTION AND FITNESS FOR A PARTICULAR PURPOSE.

SEIT EXPRESS WARRANTIES WILL NOT BE ENLARGED, DIMINISHED, OR AFFECTED BY AND NO OBLIGATION OR LIABILITY WILL ARISE OUT OF, SEIT RENDERING OF TECHNICAL OR OTHER ADVICE OR SERVICE IN CONNECTION WITH THE PRODUCTS.

THE FOREGOING WARRANTIES AND REMEDIES ARE EXCLUSIVE AND IN LIEU OF ALL OTHER WARRANTIES AND REMEDIES. THE WARRANTIES SET FORTH ABOVE CONSTITUTE SEIT SOLE LIABILITY AND PURCHASER EXCLUSIVE REMEDY FOR ANY BREACH OF SUCH WARRANTIES. SEIT WARRANTIES EXTEND ONLY TO ORIGINAL PURCHASER AND ARE NOT EXTENDED TO ANY THIRD PARTIES.

IN NO EVENT SHALL SEIT, ITS OFFICERS, DIRECTORS, AFFILIATES OR EMPLOYEES BE LIABLE FOR ANY FORM OF INDIRECT, SPECIAL, CONSEQUENTIAL OR PUNITIVE DAMAGES, ARISING OUT OF THE USE, SERVICE OR INSTALLATION OF THE PRODUCTS, WHETHER SUCH DAMAGES ARISE IN CONTRACT OR TORT, IRRESPECTIVE OF FAULT, NEGLIGENCE OR STRICT LIABILITY OR WHETHER SEIT HAS BEEN ADVISED IN ADVANCE OF THE POSSIBILITY OF SUCH DAMAGES. SPECIFICALLY, SEIT IS NOT LIABLE FOR ANY COSTS, SUCH AS LOST PROFITS OR REVENUE, WHETHER DIRECT OR INDIRECT, LOSS OF EQUIPMENT, LOSS OF USE OF EQUIPMENT, LOSS OF SOFTWARE, LOSS OF DATA, COSTS OF SUBSTITUANTS, CLAIMS BY THIRD PARTIES, OR OTHERWISE.

NOTHING IN THIS LIMITED WARRANTY SHALL SEEK TO EXCLUDE OR LIMIT SEIT LIABILITY FOR DEATH OR PERSONAL INJURY RESULTING FROM ITS NEGLIGENCE OR ITS FRAUDULENT MISREPRESENTATION OF TO THE EXTENT THAT IT CANNOT BE EXCLUDED OR LIMITED BY APPLICABLE LAW.

To obtain service under warranty you must obtain a Returned Material Authorization (RMA) number from customer support. Customers with warranty claims issues may access the SEIT worldwide customer support network through the APC web site: www.apc.com. Select your country from the country selection drop down menu. Open the Support tab at the top of the web page to obtain information for customer support in your region. Products must be returned with transportation charges prepaid and must be accompanied by a brief description of the problem encountered and proof of date and place of purchase.

APC by Schneider Electric Worldwide Customer Support

Customer support for this or any other APC by Schneider Electric product is available at no charge in any of the following ways:

- Visit the APC by Schneider Electric web site, www.apc.com to access documents in the APC Knowledge Base and to submit customer support requests.
 - **www.apc.com** (Corporate Headquarters)
Connect to localized APC by Schneider Electric web site for specific countries, each of which provides customer support information.
 - **www.apc.com/support/**
Global support searching APC Knowledge Base and using e-support.
- Contact the APC by Schneider Electric Customer Support Center by telephone or e-mail.
 - Local, country specific centers: go to **www.apc.com/support/contact** for contact information.
 - For information on how to obtain local customer support, contact the APC by Schneider Electric representative or other distributor from whom you purchased your APC by Schneider Electric product.

© 2014 APC by Schneider Electric. Smart-UPS and PowerChute are owned by Schneider Electric Industries S.A.S. or their affiliated companies. All other trademarks are property of their respective owners.