

## Smart-UPS Rack Mount Supplement

### Installation

Please observe the following items when installing the UPS.

- The UPS comes with standard 19" (46.5 cm) rack mount brackets installed. An accessory set of 24" (60.96 cm) brackets (part #SU026) is available for the 700, 1000, and 1400 VA models. Contact your dealer or the factory at the number in the back of this manual for more information.
- The 2200 and 3000 VA models of the UPS are supplied with L-channel supports. These supports may be used with these models to ease installation. The L-channel supports are available as an accessory for the 700, 1000, and 1400 VA models (part #SU032). Contact your dealer or the factory using the number in the back of this manual for more information.

**Caution! The 2200 and 3000 VA models require two or more people to install due to their weight.**

- The UPS is not supplied with screws to attach the mounting brackets (ears) to the rack, as the size of screw varies according to the type of rack used.
- UPSs are heavy. Select a rack location sturdy enough to handle the weight. Try to mount the UPS near the bottom of the rack. You may also wish to mount the UPS without its batteries and install the batteries after it is in the rack.
- Select a rack location with adequate air flow that is free from excessive dust. Ensure that the air vents on the sides of the UPS are not blocked. Do not operate the UPS where temperature or humidity are outside the limits specified in the *User's Manual*.

**Caution! Remove the UPS before transporting the rack.**

- Two additional sets of bracket holes are located on the sides of the UPS. These holes allow mounting the brackets with a three inch or six inch setback. Move the mounting brackets back if desired to optimize the esthetic or physical requirements of the rack.

**Caution! Check the rack to make sure it won't tip after moving the mounting brackets.**

### Installing the L Channel Supports

1. Verify the contents of the kit. It contains: two adjustable-length L-channel supports included with the 2200VA and 3000VA models only, four clip nuts, eight 10-32 x 1/2" flat-head screws, and eight washers. The washers are for use with square rack holes only.
2. If the rack's rails have threaded holes, drill out the appropriate front rail rack holes with a 7/32" drill bit.

#### Note:

**The mounting rails do not require clips. The threaded insert is part of the actual rail.**

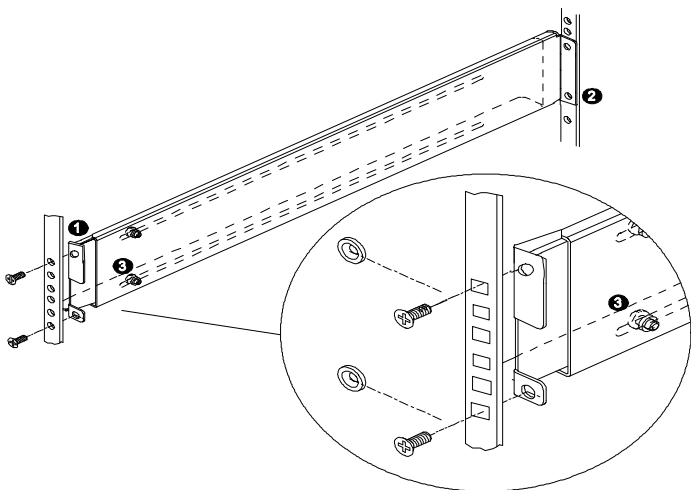

3. Secure the front of the support to the front cabinet rack using two 10-32 x 1/2" flat-head screws (shown in blow-up at left). Note that the front ear of the L-channel support has a square cutout on the mounting ear ①, and the rear ear has no cutout ②. For cabinets with square rack holes, use a washer under the head of each screw.
4. Loosen the two 10-32 x 5/16" pan-head screws that lock together the two halves of the L-channel support ③. Slide the outer half of the support to the rear until it contacts the rear rack of the cabinet. If the rack uses threaded holes, drill out the appropriate rear rail rack holes with a 7/32" drill bit (see Step 2).
5. Secure the rear of the support to the rear cabinet rack using two 10-32 x 1/2" flat-head screws (see full picture at left). For cabinets with square rack holes, use a washer under the head of each screw (see blow-up at left).
6. Securely tighten the two 10-32 x 5/16" pan-head screws that lock together the halves of the L-channel support ③.
7. Repeat steps 2 through 5 to install the other L-channel support.

8.  Mounting clips are required for the mounting ears on the UPS. Use the enclosed template (990-1095) to install the clips for the UPS ears..
9. Slide the UPS onto the L-channel supports and use rack hardware to secure the UPS mounting ears to the rack rails

**Once the UPS is mounted in the rack, please follow the installation instructions in the *Smart-UPS Quick Reference Guide*. This UPS is equipped with a SmartSlot for accessories. See the APC Website (www.apcc.com) for available accessories.**

### Rear Panels

Descriptions of the features on the rear panels are contained in the *User's Manual* for the UPS.

#### 700RM, 1000RM, 1400RM

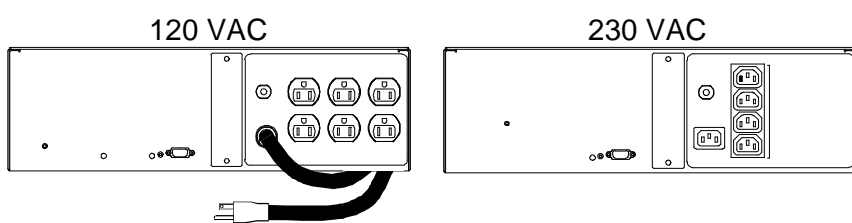

#### 1400RMXL, 2200RM, 3000RM, 2200RMXL

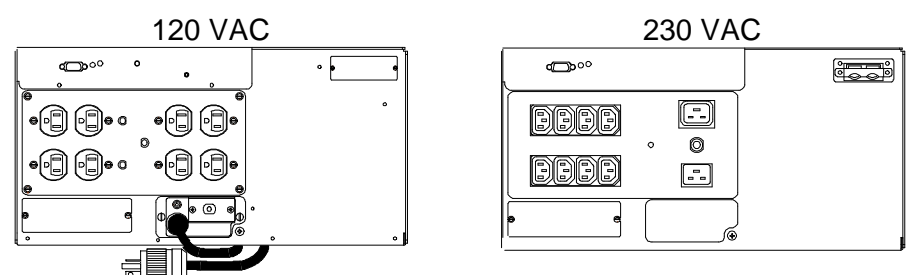

**Notes: The larger 120 VAC units (1400RMXL, 2200RM, 3000RM, 2200RMXL) require a 20, 30, or 50 amp plug. These plugs require a special outlet to be installed by a certified electrician. The rear panel of a 3000RM (5U) will support one SU48BP additional battery pack; the 3000RM (3U) does not.**

#### 2200RM, 3000RM

##### (3U Models)

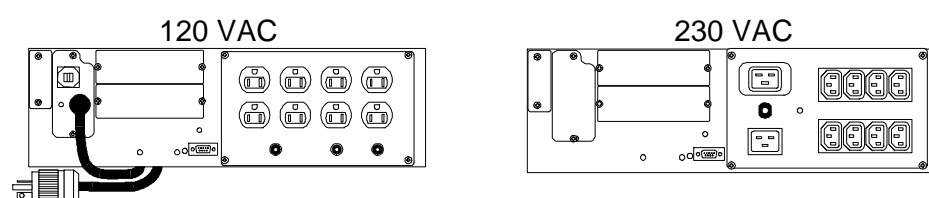

## Replacing the Battery

This UPS has an easy to replace hot-swappable battery. Battery replacement is a safe procedure, isolated from electrical hazards. You may leave the UPS and loads on for the following procedure. See your dealer or call the number in this manual for information on replacement battery kits.

**Note: Please read the cautions in the APC Safety Guide.  
Once the battery is disconnected, the loads are not protected from power outages.**

### Battery Replacement Procedures

#### 700, 100, & 1400 VA Models

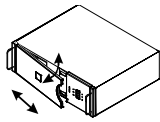

1. Reach into the finger pull and open the front cover. **Swing** the cover open as shown.

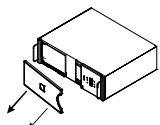

2. **Unhook** the side of the cover from the chassis and lift it away to expose the battery door.

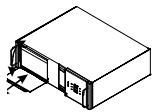

3. Use a flat-blade or Phillips screwdriver or a coin to remove the two battery door screws and **open** the door.

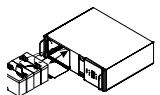

4. Grasp the tab and gently **pull** the battery out of the UPS.
5. Disconnect the battery leads. Loosen the connectors by gently wiggling them while pulling straight back from the battery connector.
6. **Connect** the battery leads to the new battery. Connect the **red** wire to the positive (+) terminal and the **black** wire to the negative (-) terminal.
7. **Slide** the battery into the UPS.
8. **Close** the battery door, **replace** the battery compartment screws, and replace the front cover.

#### Notes:

**Be careful removing the batteries - they are heavy.**

**Small sparks at the battery connectors are normal during connection.**



9. Dispose of the old battery properly at an appropriate recycling facility or return it to the supplier in the packing material for the new battery. See the new battery instructions for more information.

#### 1400XL, 2200, & 3000 VA 5U Models and 2200 & 3000 VA 3U Models

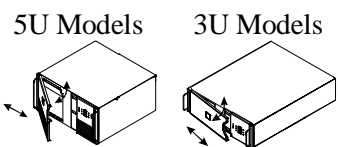

1. Reach into the finger pull and open the front cover. **Swing** the cover open as shown.

**Note: The NS2200RM and NS3000RM do not have a cover; the entire front bezel is removed.**

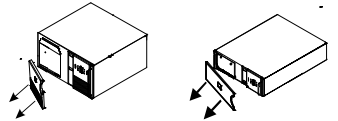

2. **Unhook** the side of the cover from the chassis and lift it away to expose the battery door.

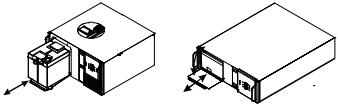

3. Use a flat-blade screwdriver or a coin to **remove** the two battery door screws and open the door.



4. Grip the white cord on the front set of batteries and **pull** firmly to disconnect the connector from the battery compartment and remove the batteries.

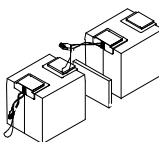

5. Set aside the foam spacer located between the batteries, if there is one.
6. Reach into the battery compartment and grasp the white cord on the other battery connector. **Pull** firmly to disconnect the connector and remove the rear set of batteries.

5U Models

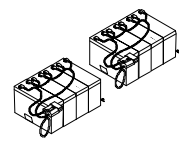

3U Models

7. Slide the rear set of new batteries into the unit. Hold the connector down below the top of the batteries and toward the door, otherwise the assembly will not fit. Guide the connector over the top of the batteries and **press firmly** to connect it to the rear connector of the battery compartment.

8. Set the foam spacer against the rear batteries to prevent the wires from being pinched.

9. **Slide** the front set of batteries in, then guide the connector over the batteries and **press firmly** to connect it to the front connector of the battery compartment.

10. **Close** the battery door, **replace** the screws, and replace the front cover.

11. Dispose of the old battery properly at an appropriate recycling facility or return it to the supplier in the packing material for the new battery. See the new battery instructions for more information.

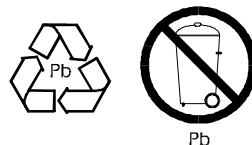

## Specifications

Model	Size (H x W x D)	Net Weight (shipping)
700RM 700RMI	13 x 48.3 x 38.1 cm 5.22 x 19 x 15 inches	18.2 (20.9) kg 40 (46) lb.
1000RM 1000RMI		20.8 (23.5) kg 46 (52) lb.
1400RM 1400RMI		25 (27.6) kg 55 (61) lb.
1400RMXL 1400RMXLI		54.5 (61.7) kg 120 (136) lb.
2200RM 2200RMI	22.2 x 48.3 x 50.8 cm 8.72 x 19 x 20 inches	58.5 (65.8) kg 129 (145) lb.
2200RMXL 2200RMXLI		61 (68) kg 134 (150) lb.
3000RM 3000RMI		58.5 (65.8) kg 129 (145) lb.
2200RM3U 2200RMI3U		46.4 (55.5) kg 102 (122) lb.
3000RM3U 3000RMI3U	13 x 48.3 x 66 cm 5.22 x 19 x 26 inches	50.9 (60.0) kg 112 (132) lb.
3000RMT3U 3000RMT3U		58 (67.1) kg 128 (148) lb.

#### Note

**Depth measurements do not include the depth of the front bezel.**

**警告使用者：**  
這是甲類的資訊產品—  
在居住的環境中使用時—  
可能會造成射頻干擾—  
在這種情況下—  
使用者會被要求採取某些適當的對策—

## Determining On-battery Run Time

This table will aid in estimating the length of run time that you may expect for a given load.

1. Obtain load figures from either the labeling on the protected equipment or the accompanying literature.
2. Add the individual loads to determine the total load. Compare the total load of the system to the run time table below.

For example, if your UPS is a 1400 and your total load is 1000VA, your runtime will be approximately half-way between that of a 1400 unit at 50% load and a 1400 unit at 100% load.

Typical On-battery Run Time Versus Load, in Minutes								
	700RM	1000RM	1400RM	2200RM (5U)	3000RM (5U)	3000RM (5U) with extra battery	2200RM (3U)	3000RM (3U)
50% Load	17	18	13	25	19	48	23	14
100% Load	5	6	5	8	5	17	8	4

