

AIS 5000[®]

10–100 kVA
400 V

Operation Manual

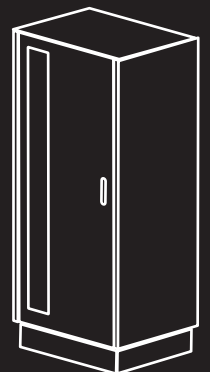

Contents

Safety	1
IMPORTANT SAFETY INSTRUCTIONS — SAVE THESE INSTRUCTIONS	1
IMPORTANT SAFETY INSTRUCTIONS — SAVE THESE INSTRUCTIONS	1
Symbols used in this manual	1
User Safety	2
About This Manual	3
Operation	4
Display	4
Overview	4
Display functions	5
Display messages	6
UPS Start/Stop	7
UPS start procedure	7
UPS stop procedure	8
Programming the UPS	10
User parameters	10
Settings for redundant systems	14
Alarms	15
Common Alarm LED	15
Audible alarm	15
Accessing the alarm log	15
Examples of alarm messages	15
Event log	19
Reading the Event Log	19
Clearing the alarm log	20

Operation Modes	21
Operation mode descriptions:	21
Normal to Bypass Operation	22
Bypass to Normal Operation	22
Normal to Manual Bypass Operation	23
Manual Bypass to Normal Operation (including start up procedure)	24

Maintenance **25**

Battery Capacity Test	25
--	-----------

Preventive Maintenance	27
---	-----------

APC preventive maintenance and part replacement recommendations	27
--	----

Safety

IMPORTANT SAFETY INSTRUCTIONS — SAVE THESE INSTRUCTIONS

IMPORTANT SAFETY INSTRUCTIONS — SAVE THESE INSTRUCTIONS

This manual contains important safety instructions for the AIS series that should be followed during installation, operation, and maintenance. See the battery installation manual for battery-specific instructions.

Symbols used in this manual



WARNING!
Risk of electric shock.



Caution

CAUTION!
Read this information to avoid equipment damage.



Note

Indicates important information.



Indicates that more information is available on this subject in a different section of this manual.



See also

Indicates that more information is available on the same subject in a different manual.

User Safety



WARNING!

- This UPS contains hazardous AC and DC voltages. Only qualified electricians should connect the UPS, AC line, and external batteries, and must be familiar with batteries and battery installation.
- Before installing, maintaining, or servicing the UPS, shut off the UPS and disconnect all sources of AC and DC power.
- As the UPS has no built-in disconnection devices to switch off external AC and DC input power, ensure that disconnection devices are available as separate parts in connection with the installation.
- AC and/or DC voltage always involves a potential risk of AC voltage at UPS output generated from either batteries or mains. To avoid equipment damage or personal injury, always assume that there may be voltage at UPS output.
- This system is equipped with an auto-start function. If activated, the system may start without warning. Refer to the “Programming the UPS” on page 10 for information on de-activation of the Autostart function.
- The installer must provide each external disconnecting device for this UPS system with labels with the following text: “Isolate the Uninterruptible Power Supply (UPS) as instructed in this guide before working on circuit.”



TEST BEFORE YOU TOUCH!

To reduce the risk of fire or electric shock, install the UPS and external batteries in a temperature and humidity controlled indoor area, free of conductive contaminants.



UPS batteries are high-current sources. Shorting battery terminals, DC terminals, or DC busbars can cause severe arcing, equipment damage, and injury. A short-circuit can cause a battery to explode. Always wear protective clothing and eye protection and use insulated tools when working on batteries.



Caution

CAUTION!

This unit contains components sensitive to electrostatic discharge (ESD). If you do not follow the ESD procedures, you may cause severe damage to electronic components.

About This Manual

This manual provides the user with an overview of the user functions of the UPS system and contains information on how to configure, monitor, and transfer the UPS from normal to battery or bypass operation with the use of the display.

Operation

Display

Overview

The display on the front of the UPS is the interface between the user and the UPS. It includes a Light Emitting Diode (LED) alarm indicator and a keyboard. The display shows measured values and alarm messages. When keys are activated, or in alarm situations, the back light will be active. It is set to switch off automatically after 5 minutes of inactivity.

The Alarm LED is a visible signal that indicates incorrect operation. If an alarm is present, the LED will be red. In normal operation, the LED is green.

Use the keyboard to program operating parameters, and to display these parameters and alarm messages. The display will also show the current operational mode of the UPS.

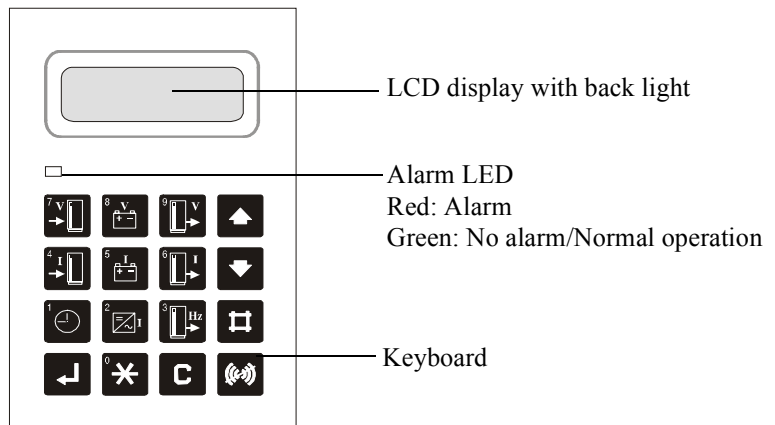

Display accuracy: $\pm 2\%$, ± 1 digit.

Display functions

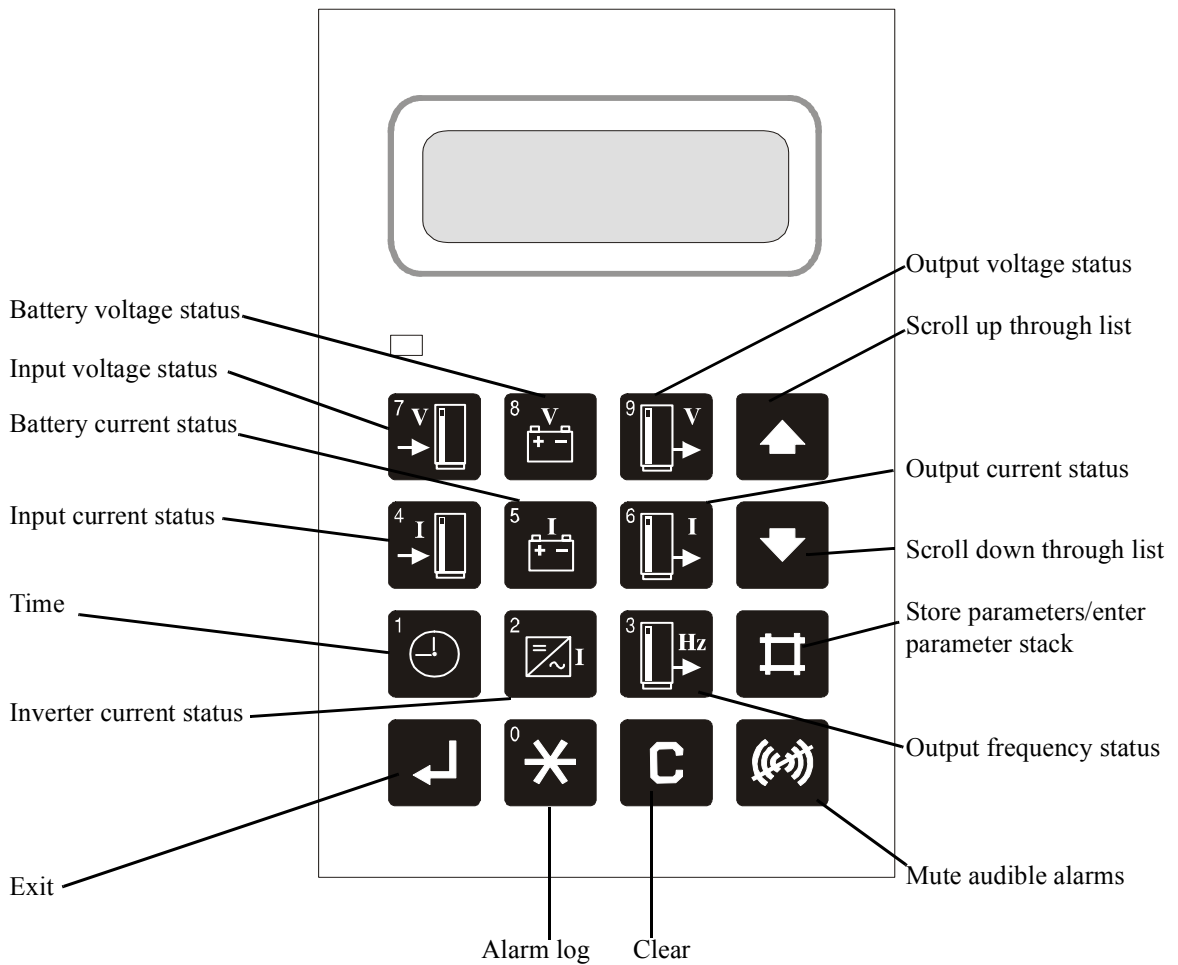

For a status report on the UPS, or to program the system, press the appropriate display key.

To increase the back light contrast, press and simultaneously. To decrease the contrast press and simultaneously.













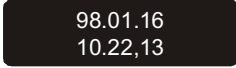

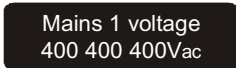

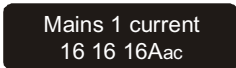

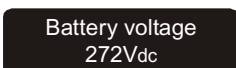

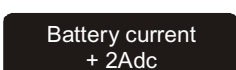

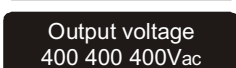

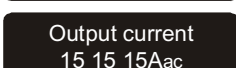

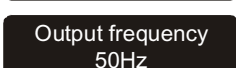

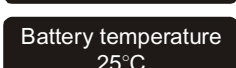
Following a 20-second period of inactivity, the display will automatically switch back to show the current operational mode.

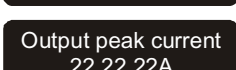

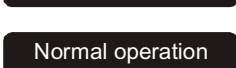
If the operation mode is changed, the display will automatically show the new operational mode. In such situations, all entries must be repeated by using the keyboard for UPS programming or status display.

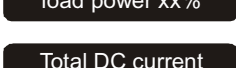
Display messages

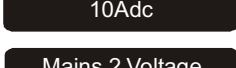
To view measurements, press one or two keys simultaneously as shown below. (Illustrated values are examples only).

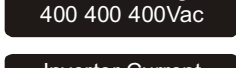
Action	Display Messages	Description
		Shows date/time: Year, month, day/hour, minute, second
		Mains 1 voltage is 3 x 400 V
		Mains 1 current is 3 x 16 A
		Battery voltage is 272 Vdc
		Charging current is (+) 2 Adc (Discharging current (-))
		Output voltage is 3 x 400 V
		Output current is 3 x 15 A
		Output frequency is 50 Hz
		Battery temperature is 25°C (77°F) (OPTION)
		Output peak current is 3 x 22 A
		Returns to normal display status. If the display is inactive for 20 sec., it will automatically switch back to show current operation mode.
		Total DC current (10Aac)
		Mains 2 voltage is 3 x 400 V
		Inverter current is 3 x 40 A

UPS Start/Stop



WARNING!

AC voltage generated from either batteries or mains may be present at the UPS output. Before UPS Start/Stop, always disconnect AC input supply source, switch off the UPS, AND switch off the DC supply. TEST BEFORE YOU TOUCH!

Only an authorized electrician may start up or shut down the UPS system, and the instructions in the Installation Manual must be followed. Leave the UPS in shut-down mode for a minimum of 5 minutes before performing any service checks.

10–30 kVA

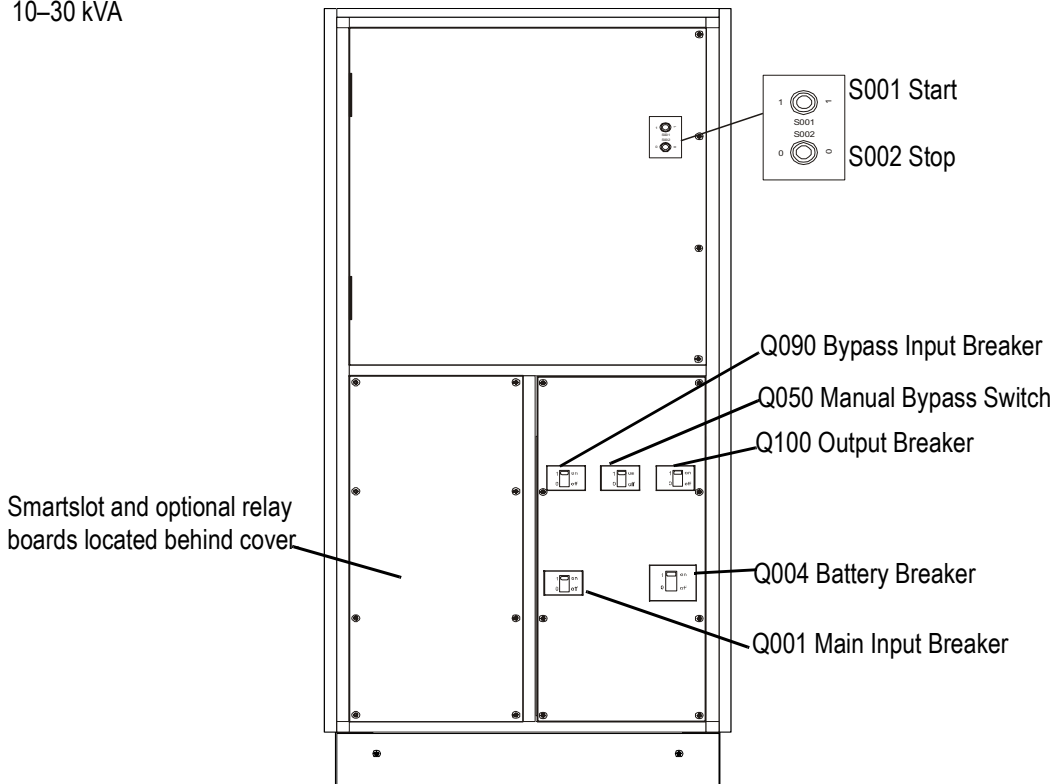





UPS start procedure

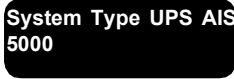

Note

If the UPS is programmed for Autostart, the system will automatically start after 60 seconds, provided that the rectifier mains is switched ON and operating within the tolerance range.

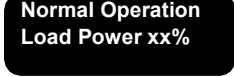
<ol style="list-style-type: none">1. Switch on the rectifier mains supply by closing Q001. The display shows: After 10 seconds the display changes to:2. Push the S001 button “Start”. The display shows:3. Check the battery voltage reading on the display by pushing  . (Battery voltage: 272Vdc).4. Connect the battery by closing the Q004.5. Check that the inverter output voltage is within tolerance range by pushing 6. To switch on the bypass mains supply, close breaker Q090.7. Wait 10 seconds to make sure that the UPS is synchronized.8. Connect the output by closing the Q100 breaker.9. Verify that the Alarm LED light switches to green. <p>The UPS start procedure is now complete.</p>	  
--	---

UPS stop procedure



CAUTION!

Ensure that all users supported by the UPS are informed about the shutdown of the UPS before proceeding.

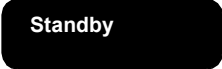











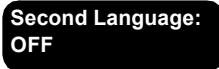

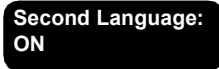



<ol style="list-style-type: none">1. To turn OFF the bypass mains supply, open breaker Q090.2. Push S002 (Stop). The display shows:3. Disconnect the battery by opening the Q004 breaker.4. Turn off the rectifier mains supply by opening the Q001 breaker. <p>After approximately 30 seconds the display will be inactive. All LED indications are switched off.</p> <p>The UPS stop procedure is now complete.</p>	
--	---



















The shutdown of the UPS causes the DC capacitor bank to discharge meaning that the UPS contains no voltage. However, hazardous voltage still remains in the connecting terminals and the rectifier mains, bypass mains, and batteries. Make sure that the input terminals (mains 1 and 2) and the output terminals are disconnected. Pressing the S002 stop button disconnects the output terminals. Always verify that there is no output voltage before proceeding.

Programming the UPS

User parameters

Parameter	Comments
Language	<p>Default language: English. Second language: German.</p> <p>To activate the second language, push  and browse through the menu, using the cursor keys  or  until the display shows: </p> <p>To activate the second language, push . The display shows: </p> <p>To return to English, push .</p>
Autostart	<p>To activate the autostart function, push  and browse through the menu, using the cursor keys  or  until the display shows: </p> <p>To activate the autostart function, push . To deactivate, press .</p> <p>If Autostart is on and the UPS is in Standby mode, the UPS will restart automatically when the mains supply is restored.</p>
Bypass Operation	<p>Push  and the cursor keys  or  until the display shows: </p> <p>To select Bypass Operation, push .</p> <p>The UPS will switch to Bypass Operation if the bypass mains is within the specified tolerance range. The display will show: </p> <p>The load is now supplied from the bypass mains through the static switch. Bypass mains voltage and output voltage will appear on the display.</p> <p>To return to Normal Operation, push .</p> <p>The UPS transfers from one operation mode to another without affecting the load.</p>

<p>Boost Charge</p>	<p>To program the UPS for Boost Charge, press  and browse through the menu, using the cursor keys  or .</p> <p>The display shows:</p> <div data-bbox="1214 378 1437 450" style="float: right; border: 1px solid black; background-color: black; color: white; padding: 2px; border-radius: 10px;"> Boost Charge: OFF </div> <p>Choose Boost Charge by selecting  . To deactivate, press .</p> <p>When the Boost Charge function is selected, the UPS will remain in the Boost Charge operational mode for 8 hours. To change the boost charge operating time, contact APC. (The UPS can be programmed to stay in this mode for up to 24 hrs).</p>
<p>Auto Boost Charge</p>	<p>To program the UPS for Auto Boost Charge, select .</p> <p>Browse through the menu, using the cursor keys  or  until this message appears:</p> <div data-bbox="1214 792 1437 864" style="float: right; border: 1px solid black; background-color: black; color: white; padding: 2px; border-radius: 10px;"> Auto Boost Charge: OFF </div> <p>Select Auto Boost Charge by pressing  . Deactivate by pressing .</p> <p>When the Auto Boost Charge function is selected, the system will automatically switch to Boost Charge Operation if the battery has been discharged.</p> <p>The UPS will only stay in the Boost Charge operational mode for 8 hours. When the UPS is working in Auto Boost Charge operational mode, the charger is outside the battery current limitation. To change the Auto Boost Charge operating mode, contact APC. (The UPS can be programmed to stay in this mode up to 24 hrs).</p>

<p>Battery Capacity Test</p>	<p>Make sure the UPS has been in normal operation for at least 8 hours and that the batteries are fully charged before performing this test.</p> <p>To test the Battery Capacity press  and browse through the menu, using the cursor keys  or  until the display shows:</p> <p>(xxx indicates the backup time from the last Battery Capacity test). If this test has not been performed before – or if the test has been aborted, the display shows:</p> <p>To proceed with the test, press  or  to abort.</p> <p>The display shows:</p> <p>Wait until the display shows:</p> <p>a short audible alarm will sound.</p> <p>Press  until the display shows: (xxx represents the actual backup time in minutes)</p> <p>Press  or wait 20 seconds until the display shows:</p> <p>If a mains failure occurs during a battery capacity test, the test will immediately abort. No test results will be obtained and the display will show:</p>
------------------------------	---

Battery Capacity Test: xxx

???









Battery Operation Time > ...min













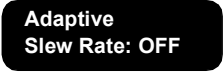

Normal Operation Load Power xx%

Battery Capacity Test: xxx

Normal Operation Load Power xx%

???

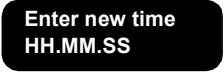
<p>Battery Monitor Test</p>	<p>This parameter will only appear on the display, if the Advanced Battery Monitor option is installed.</p> <p>To perform the Battery Monitor Test, push  and browse through the menu, using the cursor keys  or  until the display shows:</p> <div data-bbox="1214 376 1437 450" style="float: right; border: 1px solid black; background-color: black; color: white; padding: 2px;">Battery Monitor Test: OFF</div> <p>To perform a Battery Monitor Test, select . To deactivate, press .</p> <p>The Battery Monitor Test checks the battery condition by switching off the rectifier, and running the inverter in battery operation until 25% of the battery capacity is used.</p> <ul style="list-style-type: none"> • In the event of a battery failure, the rectifier will automatically switch on. There will be no output voltage loss. • If the battery condition is within the tolerance range, no alarms will appear on the display. • In case of reduced battery capacity, one of the following two alarms will appear on the display: <ul style="list-style-type: none"> – Battery Monitor Warning — means that the battery capacity is reduced by 25% or more. – Battery Monitor Alarm — no battery capacity or capacity is reduced by 50% or more. <div data-bbox="1214 1086 1437 1160" style="float: right; border: 1px solid black; background-color: black; color: white; padding: 2px;">Battery Monitor Warning</div> <div data-bbox="1214 1189 1437 1263" style="float: right; border: 1px solid black; background-color: black; color: white; padding: 2px;">Battery Monitor Alarm</div>
<p>Battery Monitor Reset</p>	<p>This parameter will only appear on the display if the Advanced Battery Monitor option is installed.</p> <p>To reset the battery monitor, push  and browse through the menu, using the cursor keys  or  until the display shows:</p> <div data-bbox="1214 1534 1437 1608" style="float: right; border: 1px solid black; background-color: black; color: white; padding: 2px;">Battery Monitor Reset: OFF</div> <p>To reset the Battery Monitor Alarms, press .</p>

Settings for redundant systems	
<p>Adaptive Slew Rate</p>	<p>To program the UPS for Adaptive Slew Rate, press .</p> <p>Browse through the menu, using the cursor keys  or  until the display shows: </p> <p>Select Adaptive Slew Rate by pressing .</p> <p>Deactivate by pressing .</p>
<p>Enter New Date</p>	<p>To program the date setting, press .</p> <p>Browse through the menu, using the cursor keys  or  until the display shows: </p> <p>Enter the new date by using the numeric keys. Enter the year, month, and day.</p> <p>Store the by pressing .</p>
<p>Enter New Time</p>	<p>To program the time setting, press .</p> <p>Browse through the menu, using the cursor keys  or  until the display shows: </p> <p>Enter the new time by using the numeric keys. Enter the hour, minute, and second.</p> <p>Store the time by pressing .</p>

Alarms



Common Alarm LED

In alarm situations, the Common Alarm LED above the keyboard will change from green to red and the alarm will be registered in the alarm log. The Alarm LED remains red for as long as the alarm is active.

Audible alarm

An audible alarm will sound for up to 30 seconds. If the problem that caused the alarm is rectified in less than 30 seconds, the audible alarm will switch off automatically. If several alarms overlap each other, the audible alarm will sound for an additional 30 seconds.

Accessing the alarm log

The alarm log registers all active messages. The most recent alarm is registered at the top of the alarm log. To read alarm messages in the alarm log press  and to browse through the list of alarms use the cursor keys  or . The bottom message is “No (Further) Alarms”.



Note

The alarms are only present in the alarm log as long as the red Common Alarm LED is on. To exit the alarm log, wait for 20 seconds or push .

Some alarms will only be registered in the event log.

Examples of alarm messages

Alarm #	Display Text	Description	Recommendations
4	System set in manual BYPASS	Built-in manual bypass switch is in Bypass and the load is supplied directly from the bypass mains.	See section on operating modes (instructions on how to switch back to normal operation).
5	TSM 1 temp Warning	Temperature of UPS inverter module has reached warning level.	Check if fans are running and check for airflow obstructions. Contact APC Customer Support.
6	TSM 1 temp Shutdown	Temperature of UPS inverter module has reached critical level and the inverter module has been shut down.	Check if fans are running and check for airflow obstructions. Contact APC Customer Support.

7	TSM 2 temp Warning	Temperature of UPS inverter module has reached warning level.	Check if fans are running and check for airflow obstructions. Contact APC Customer Support.
8	TSM 2 temp Shutdown	Temperature of UPS inverter module has reached critical level and the inverter module has been shut down.	Check if fans are running and check for airflow obstructions. Contact APC Customer Support.
9	TSM 3 temp Warning	Temperature of UPS inverter module has reached warning level.	Check if fans are running and check for airflow obstructions. Contact APC Customer Support.
10	TSM 3 temp Shutdown	Temperature of UPS inverter module has reached critical level and the inverter module has been shut down.	Check if fans are running and check for airflow obstructions. Contact APC Customer Support.
11	Battery Monitor Alarm	Battery health has reached critical level — less than 50% backup time must be expected.	Change the batteries ASAP.
14	Battery Monitor Warning	Battery health has reached critical level — less than 75% backup time must be expected.	Perform a battery capacity test to verify backup time. Some of the batteries may have to be exchanged.
15	Battery MCB OFF	Battery MCB has tripped or has been switched off.	Check for DC bus fault - contact APC Customer Support.
16	Bypass Frequency out of Tolerance	Bypass mains is outside the accepted UPS tolerances.	Check quality of mains.
17	Bypass Instantaneous out of Tolerance	Bypass mains is outside the accepted UPS tolerances.	Check quality of mains.
18	Bypass out of Tolerance	Bypass mains is outside the accepted UPS tolerances.	Check quality of mains.
19	Charge reg. Error	UPS charger is not working properly.	Contact APC Customer Support.
20	Charger 0 temp Warning	Temperature of UPS charger module has reached warning level.	Check if fans are running and check for airflow obstructions. Contact APC Customer Support.
21	Charger 0 temp Shutdown	Temperature of UPS charger module has reached critical level and the charger module has been shut down.	Check if fans are running and check for airflow obstructions. Contact APC Customer Support.
22	Charger 30 temp Warning	Temperature of UPS charger module has reached warning level.	Check if fans are running and check for airflow obstructions. Contact APC Customer Support.
23	Charger 30 temp Shutdown	Temperature of UPS charger module has reached critical level and the charger module has been shut down.	Check if fans are running and check for airflow obstructions. Contact APC Customer Support.
24	Current Limiter Active	UPS inverter is in current limitation.	Contact APC Customer Support if problem persists.

25	OVERLOAD is > 100%	Load on the output side of the UPS has reached more than 100%.	If overload is permanent, reduce load on output.
26	High DC Warning	DC bus voltage has reached warning level.	May occur if big loads are switched off - check for load steps. If problem persists, contact APC Customer Support.
27	High DC Shutdown	DC bus voltage has reached shutdown level - the charger and inverter is switched off - UPS is in bypass operation.	Contact APC Customer Support.
28	High Output Voltage	UPS output is high and outside tolerance - UPS is in bypass operation.	Contact APC Customer Support.
31	High temp Charger Magnetic	Charger transformer has reached high temperature - UPS is in battery operation.	Check if fans are running and check for airflow obstructions. Contact APC Customer Support.
32	High temp Invert. Magnetic	Inverter transformer has reached high temperature - UPS is in bypass operation.	Check if fans are running and check for airflow obstructions. Contact APC Customer Support.
33	High Battery Temperature (OPTION)	Temperature in battery cabinet is too high.	Check ambient temperature and check for airflow obstructions.
34	Inverter Voltage Error	UPS inverter voltage is out of tolerance.	May occur during UPS start up. If problem persists, contact APC Customer Support.
35	Inverter Fuse Blown	UPS inverter fuses are open - UPS is in bypass operation.	Contact APC Customer Support.
36	Low DC Warning	UPS is in battery operation and battery energy is almost depleted.	Check quality of mains.
37	Low DC Shutdown	Battery energy is depleted.	Check quality of mains.
38	DC Current Limit	UPS charger is in current limitation.	If problem persists, contact APC Customer Support.
39	Input Frequency out of Tolerance	Input mains is outside accepted tolerances for the UPS.	Check quality of mains.
41	Input is out of Tolerance	Input mains is outside accepted tolerances for the UPS.	Check quality of mains.
42	Output Frequency out of Tolerance	UPS output is outside accepted tolerances.	Check quality of mains.
43	Output Instantaneous out of Tolerance	UPS output is outside accepted tolerances.	Check quality of mains.
44	Output is out of Tolerance	UPS output is outside accepted tolerances.	Check quality of mains.

45	Output Switch Open	The built-in output switch is open - the load cannot be supplied from the UPS.	See section on operating modes (instructions on how to switch back to normal operation).
47	Static Switch 2 temp Shutdown	Temperature of UPS static switch module has reached shutdown level.	Check if fans are running and check for airflow obstructions. Contact APC Customer Support.
48	Static Switch 2 temp Warning	Temperature of UPS static switch module has reached warning level.	Check if fans are running and check for airflow obstructions. Contact APC Customer Support.
49	Static Switch 3 temp Shutdown	Temperature of UPS static switch module has reached shutdown level.	Check if fans are running and check for airflow obstructions. Contact APC Customer Support.
50	Static Switch 3 temp Warning	Temperature of UPS static switch module has reached warning level.	Check if fans are running and check for airflow obstructions. Contact APC Customer Support.
51	Synchronization Error	UPS is not synchronized to the mains.	Check quality of mains.
52	System Locked in Operation Mode	Due to several rapid operation mode changes, UPS is locked in operation mode.	Contact APC Customer Support.
54	Fan Fault	One or more fans not running in correct RPM or not functioning at all.	Check if fans are running and check for airflow obstructions. Contact APC Customer Support.
55	Fault in Int. Power Supply	Problem in one of the UPS power supply units.	Contact APC Customer Support.
58	Calibration Stack Entered	Calibration Stack has been activated.	Exit calibration stack.
60	MPU is reset	Main UPS controller has been reset.	Normal alarm when UPS has been powered down.

Additional alarms in the event log

Alarm #	Display Text	Description	Recommendations
0	OFF button pushed	Red S002 OFF button has been pushed to switch off the UPS or the remote button has been activated.	See section on starting/stopping the UPS.
1	ON button pushed	Green S001 button has been pushed to switch on the UPS or the remote button has been activated.	See section on starting/stopping the UPS.
61	Standby	UPS is ready to start up. Push S001 “ON button”.	See section on starting/stopping the UPS.
62	Normal Operation	UPS is in normal operation.	See section on operation modes for more information.

Additional alarms in the event log			
63	Battery Operation	UPS is in battery operation, using the battery energy.	See section on operation modes for more information.
64	Bypass Operation	UPS is in bypass operation, the load is supplied directly from the bypass mains.	See section on operation modes for more information.
65	Charger Only	Only the charger is operating.	See section on operation modes for more information.
66	Economy Operation	UPS is in permanent bypass operation.	See section on operation modes for more information.
67	Hot Standby	Only used for parallel redundant configurations.	See section on operation modes for more information.





Event log

The event log contains the latest 250 alarms. All events are time-stamped. Both alarms and operation mode changes are stored in the event log.



Operation mode will change as follows (see below example):

Logged Mode:	MPU is reset
Logged Mode:	Standby
Logged Mode:	Normal Operation
Logged Mode:	Battery Operation
Logged Mode:	Bypass Operation
Logged Mode:	Charger Only
Logged Mode:	Economy Operation
Logged Mode:	Hot Standby
No (further) Event	

Reading the Event Log

To access the event log, press  and  and browse through the alarm log by using  or . The last message in the alarm log is: No (further) Event. To check the occurrence of the events, push the cursor keys as described above and, at the actual event, press . The occurrence of the event will be displayed as (yy/mm/dd/hours/min/sec).





The UPS can be set to local time or UTC (Universal Time Coordinate), also known as GMT. The display will show the selected time setting. To check the time setting, wait until the display shows an operational mode. Then select  and the display will show the actual time in the chosen time mode. To exit the log, wait for 20 seconds, or press .



If the event log is cleared, there will be no record of previous alarms or events. Only APC trained personnel should clear the event log.

Clearing the alarm log

To clear the alarm log:

Press  and  simultaneously. The display will show:
Enter the password : 920701.



Key in Password

This action clears the alarm log and the display will show:



Logging Stack
is Reset

Operation Modes

The display automatically indicates the current UPS operation mode. See the table below for examples of operation modes and their descriptions.

Operation mode descriptions:

Operation Mode	Description of Operation Mode
Normal Operation	The inverter supplies the load. The charger uses the mains supply to feed the inverter.
Battery Operation	The inverter supplies the load. The battery bank supplies the inverter. In battery operation the load support time is limited; when the batteries are discharged the UPS is unable to supply the load.
Bypass Operation	The bypass static switch supplies the load, meaning that the load is supplied directly from the bypass mains. When working in bypass operation the UPS can switch to battery operation if the bypass mains fails.
Charger Only	The charger is recharging the battery. The inverter is shut down.
Economy Operation	The UPS is in permanent bypass operation and will only switch to battery operation if the bypass mains is out of tolerance.
Hot Standby	In redundant configurations, one UPS can switch off the inverter, but still keep the inverter ready for immediate start in case another UPS fails.



Note





In standby mode, the UPS has no output voltage.



Note

Users do not require electrical qualifications to switch the UPS to and from standby mode/normal operation.

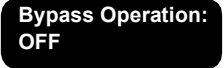
Normal to Bypass Operation

Press  and the cursor keys  or  until the display shows:	
Press  . If the bypass mains is within the tolerance range, the UPS will transfer to electronic bypass. The display shows:	



Note

The load is now supplied directly from the bypass mains.





If the bypass mains fails during bypass operation, the UPS will automatically switch to normal operation, provided that the rectifier mains is available. If the battery supply is available, and within the tolerance range, the UPS will switch to battery operation.



Note

Depending on the programming, a short loss of output voltage may occur.

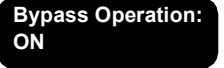
Bypass to Normal Operation

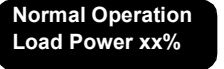
1. Press  and the cursor keys  or  until the display shows:	
2. Press  . The display will show:	



Note

The load is now supplied by the UPS.







Normal to Manual Bypass Operation



CAUTION!

Never operate the manual bypass switch when the UPS is in normal operation.

Caution

<p>Press  and the cursor keys  or  until the display shows:</p>	
<p>Press . If the bypass mains is within tolerance range, the UPS will transfer to electronic bypass. The display shows:</p>	
<p>Make sure that the Bypass Static Switch is turned on.</p>	
<p>Switch on the Manual Bypass Switch (Q050).</p>	
<p>Switch off the Output Breaker Q100.</p>	
<p>Push the S002 button on the front panel in order to turn the UPS off. The UPS changes to standby operation. Display shows:</p>	
<p>Switch off the Q090, Q001 and Q004 breakers.</p>	
<p>Wait 30 seconds until the UPS display and all LED indications are switched off.</p>	



Note

The load is now supplied directly from the bypass mains.











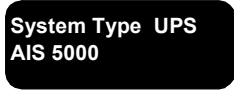

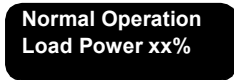

CAUTION!

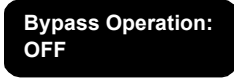
When the UPS is in bypass operation, the load support will be disrupted if the bypass mains fails.

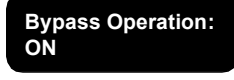
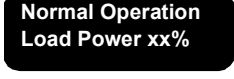
Caution

Manual Bypass to Normal Operation (including start up procedure)

<p>1. Switch on the rectifier mains supply by closing the Q001 breaker. The display shows:</p> <p>After 10 seconds the display message changes to:</p>	  
<p>2. Press the S001 Start button on the front panel. The display shows:</p>	
<p>3. Check the battery voltage reading on the display by selecting .</p>	
<p>4. Connect the battery by closing the Q004 breaker.</p>	
<p>5. Check that the inverter output voltage is within tolerance range by pressing .</p>	
<p>6. Switch the Q090 breaker on.</p>	
<p>7. Wait 10 seconds to ensure that the UPS is synchronized.</p>	
<p>8. Switch the UPS to bypass operation by pressing  and the cursor keys  or  until the display shows:</p>	 
<p>9. Press  and if the bypass mains is within the tolerance range, the UPS will transfer to electronic bypass. The display shows:</p>	
<p>10. Make sure that the Bypass Static Switch is on.</p>	
<p>11. Switch the Q100 output breaker on.</p>	
<p>12. Switch the Manual Bypass Switch (Q050) off.</p>	 
<p>13. Switch the UPS to normal operation by pressing  and the cursor keys  or  until the display shows:</p>	
<p>14. Press . The display will show:</p>	
<p>15. Verify that the Alarm LED changes to green.</p>	



The load is now supported by the UPS.

Maintenance

Battery Capacity Test

To ensure optimum operation, preventive maintenance is recommended. UPS maintenance should be carried out by APC trained service engineers only.









Refer to the Safety section of this manual before operating the UPS.

APC recommends an annual battery capacity test as a minimum to ensure battery discharge in accordance with specifications given by the manufacturer. The test provides information on the battery backup time for the actual load. Prior to this test, the batteries should be fully charged and the rectifier should operate in float charge mode.

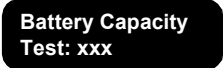
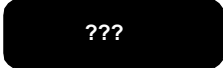
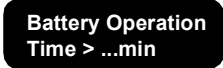
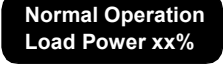
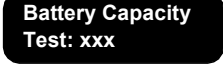
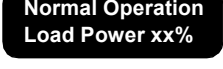
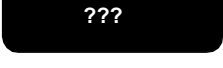

A battery capacity test should always be coordinated with the operator(s) of the connected load. If a mains failure should occur during or after this test, the backup time will be affected, as the battery capacity will be low at the end of a capacity test.

<p>Make sure the UPS has been in normal operation for at least 8 hours and that the batteries are fully charged before performing this test.</p> <p>To test the Battery Capacity press  and browse through the menu by using the cursor keys  or  until the display shows:</p> <p>(xxx indicates the backup time from the last Battery Capacity test). If this test has not been performed before, or if the test has been aborted, the display shows:</p> <p>To proceed with the test, press  or  to abort.</p> <p>The display shows:</p> <p>Wait until the display shows:</p> <p>A short audible alarm will sound.</p> <p>Press  until the display shows: (xxx represents the actual backup time in minutes)</p> <p>Press  or wait 20 seconds until the display shows:</p> <p>If a mains failure occurs during a battery capacity test, the test will immediately abort. No test results will be obtained and the display will show:</p>	      
---	---



After a battery capacity test, allow for between 8–24 hours (depending on battery type) for the battery to recharge to full backup capacity.

Preventive Maintenance

APC preventive maintenance and part replacement recommendations

APC recommends a preventive maintenance visit every 12 months and replacement of the cooling fans and batteries as described below.

A preventive maintenance check will include:

- Visual check
- Wiring connection check
- UPS cleaning and inspection
- Battery check
- Display function check
- Battery capacity or battery monitor test (See the section “Battery Capacity Test” on page 25)
- Modes of operation check
- Power outage test
- Critical component temperature check

Safety precautions must be observed while performing maintenance checks. For more information on preventive maintenance checks, or to schedule a maintenance check with an APC-authorized field service representative, call APC Global Services (AGS) or the nearest APC office (See back cover for phone number). The AGS representatives are available 24 hours a day. Spare parts are available to our customers for at least 10 years after the UPS production date.

APC recommends that the following parts be replaced within the period mentioned below:

Part	Average Life
Fan	4–5 years
AC/DC Capacitors	8 years
Controller Battery	10 years
Power Supply Unit	8 years



Note

Only APC trained personnel should perform service repairs on an APC UPS.

Warranty

Factory Warranty

APC warrants that the unit, when properly installed and commissioned by APC or APC authorized service personnel, shall be free from defects in materials and workmanship for a period of (1) year from the date of installation or maximum 18 months after manufacturing. In the event that the unit fails to meet the foregoing warranty, APC shall for a period of one (1) year repair or replace any defective parts, without charge for on-site labor and travel if trained & authorized APC personnel has conducted start-up of the unit.

An APC Start-Up Service must be performed/completed by APC or by service personnel authorized by APC. If not, the on-site factory warranty will be voided and replacement of defective parts only will be covered. APC shall have no liability and no obligation to repair the installed unit if non-authorized APC personnel performed the start-up and such start-up caused the unit to be defective.

APC shall not be liable under the warranty if its testing and examination disclose that the alleged defect in the product does not exist or was caused by purchaser's or any third person's misuse, negligence, improper installation or testing, unauthorized attempts to repair or modify, or any other cause beyond the range of the intended use, or by accident, fire, lightning or other hazard.

There are no warranties, expressed or implied, by operation of law or otherwise, of products sold, serviced or furnished under this agreement or in connection herewithin. APC disclaims all implied warranties of merchantability, satisfaction and fitness for a particular purpose. APC's express warranties will not be enlarged, diminished, or affected by and no obligation or liability will arise out of, APC rendering of technical or other advice or service in connection with the products. The foregoing warranties and remedies are exclusive and in lieu of all other warranties and remedies. The warranties set forth above, constitute APC's sole liability and purchaser's exclusive remedy for any breach of such warranties. APC's warranties apply only to purchaser and are not extended to any third parties.

In no event shall APC, its officers, directors, affiliates or employees be liable for any form of indirect, special, consequential or punitive damages, arising out of the use, service or installation, of the products, whether such damages arise in contract or tort, irrespective of fault, negligence or strict liability or whether APC has been advised in advance of the possibility of such damages.



APC Worldwide Customer Support

Customer support for this or any other APC product is available at no charge in any of the following ways:

- Visit the APC Web site to access documents in the APC Knowledge Base and to submit customer support requests.
 - **www.apc.com** (Corporate Headquarters)
Connect to localized APC Web sites for specific countries, each of which provides customer support information.
 - **www.apc.com/support/**
Global support searching APC Knowledge Base and using e-support.
- Contact an APC Customer Support center by telephone or e-mail.
 - Regional centers:

Direct InfraStruXure Customer Support Line	(1)(877)537-0607 (toll free)
APC headquarters U.S., Canada	(1)(800)800-4272 (toll free)
Latin America	(1)(401)789-5735 (USA)
Europe, Middle East, Africa	(353)(91)702000 (Ireland)
Japan	(0) 3 5434-2021
Australia, New Zealand, South Pacific area	(61) (2) 9955 9366 (Australia)

- Local, country-specific centers: go to **www.apc.com/support/contact** for contact information.

Contact the APC representative or other distributor from whom you purchased your APC product for information on how to obtain local customer support.

Entire contents © 2005 American Power Conversion. All rights reserved. Reproduction in whole or in part without permission is prohibited. APC, the APC logo, and AIS 5000 are trademarks of American Power Conversion Corporation and may be registered in some jurisdictions. All other trademarks, product names, and corporate names are the property of their respective owners and are used for informational purposes only.

