

Secondary Distribution Switchgear

FBX

SF6 Gas-insulated switchboards

Instructions Operation - Maintenance



1	Schneider Electric at your service	1
1.1	Particular instructions for operations and interventions	1
1.2	Protection equipments	1
1.3	Cleaning instructions	2
1.4	Symbols of information	2
1.5	Symbols and important safety informations	2
1.6	Contacts	2
2	With regards to this User Manual	3
2.1	Other technical manuals to be consulted	3
2.2	Tools (not supplied) required for the operations described in this user manual	3
3	Functional interlocks	4
3.1	Functional mechanical interlocks	4
3.2	Interlocks for functions C and T1	4
3.3	Interlocks for functions T2 and CB	4
3.4	Interlocks for function CBb	5
3.5	Interlocks for function Sb	5
4	Operating accessories	6
4.1	Reminder for Manual Operations	6
4.2	Operating accessories	6
4.3	Lockouts using padlocks (Optional)	6
5	Use of the C function	7
5.1	Opening the earthing switch	7
5.2	Closing the earthing switch	7
5.3	Closing the load break switch	8
5.4	Opening the load break switch	8
5.5	Operation of motorized control mechanisms	8
6	Use of the T1 function	9
6.1	Opening the earthing switch	9
6.2	Closing the earthing switch	9
6.3	Closing the load break switch	9
6.4	Manually opening the load break switch	9
6.5	Operation of motorized control mechanisms	9
7	Use of the T2 function	10
7.1	Opening the earthing switch	10
7.2	Closing the earthing switch	10
7.3	Closing the line isolating switch [circuit breaker open]	10
7.4	Opening the line isolating switch [circuit breaker open]	10
7.5	Closing the circuit breaker [Line Isolator closed]	11
7.6	Opening the circuit breaker [Line Isolator closed]	11
7.7	Closing the circuit breaker [Line Isolator open]	11
7.8	Operation of motorized control mechanisms	11
8	Use of the Sb function	12
8.1	Opening the earthing switch	12
8.2	Closing the earthing switch	12
8.3	Closing the load break switch	12
8.4	Opening the load break switch	12
8.5	Operation of motorized control mechanisms	12
9	Using motorized functions	13
9.1	Operation of motorized control mechanisms [Optional]	13
9.2	Manual emergency operation of motorized controls	13
9.3	Approximate number of turns for backup manual control levers	13
9.4	Manual interventions involving Functions C, T1 and Sb [Earthing switch open]	13
9.5	Manual interventions involving Function T2 [Earthing switch open]	14
10	Maintenance	15
10.1	Levels of maintenance	15
10.2	Preventive maintenance	15
10.3	Corrective maintenance	15
10.4	Replacement of the three fuses	15
	Replacement of a fuse	15

	Processing old fuses and packaging	17
10.5	Replacement of a voltage indicator unit [E.g.: Type VPIS]	18
10.6	Periodic frequency for maintenance operations of the VDS boxes	18
11	Policy for Adaptation and Replacement of Schneider Electric	19
11.1	Definitions	19
11.2	Different categories of spare parts [according to NF EN 13306 - NF X 60-319]	19
11.3	Supply of spare parts	19
11.4	Identification and storage of the parts	19
11.5	Presentation of the PAR	19
	Illustrated example of PAR	20
11.6	Reuse or waste processing of replaced parts and packaging	20
12	Cable testing	21
12.1	Preparation of the function	21
12.2	Cable testing with plug-in 'T' piece connectors (busbar energized)	21
12.3	Cable tests: EON specification with plug-in 'T' piece connectors [busbar energized]	22
12.4	Testing the casing of plug-in connectors	22
13	Characteristics and Volumes of SF6 gas	23
13.1	General characteristics	23
13.2	Filling pressure	23
13.3	Operating thresholds of the pressure gauge contacts	23
13.4	FBX functions	23
14	At the end of the equipment's operational life	24
14.1	Valorization of the equipment	24
14.2	Safety instructions	24
14.3	Dismantling of the equipment service	24
14.4	Distribution and valorization of the materials used for FBX (See § 14.1)	25
15	Notes	26

© - Schneider Electric - 2010. Schneider Electric, the Schneider Electric logo and their figurative forms are Schneider Electric registered trademarks. The other brand names mentioned within this document, whether they be copyright or not, belong to their respective holders.

Schneider Electric request the carefully reading of the following instructions in order to familiarize yourself with the product in this document before trying to install, operation, put into service or conduct the maintenance on it.

Our products are fully quality controlled and tested at the factory in accordance with the standards and regulations currently in force.

The correct functioning and lifespan of the product depend on respecting the installation, commissioning and exploitation instructions found in this manual. Not respecting these instructions is likely to invalidate any guarantee.

Local safety requirements which are in accordance with these instructions, especially those regarding the safety of product operators and other site workers, must be observed.

Schneider Electric declines any responsibility for the following points:

- the non respect of the recommendations in this manual which make reference to the international regulations in force.
- the non respect of the instructions by the suppliers of cables and connection accessories during installation and fitting operations,
- possible aggressive climatic conditions (humidity, pollution, etc.) acting in the immediate environment of the materials that are neither suitably adapted nor protected for these effects.

1.1 Particular instructions for operations and interventions

This user manual does not list the locking-out procedures that must be applied. The interventions described are carried out on de-energized equipment (in the course of being installed) or locked out (non operational).

Whilst commissioning and operating the product all general safety instructions for electrical applications (protective gloves, insulating tools, etc.) must be respected, this in addition to the standard operating instructions.

All operations must be completed once started.

The durations (for completing the operations mentioned) given in the maintenance tables are purely an indication and depend on on-site conditions.

1.2 Protection equipments

Only qualified and accredited people can operate on our products. They must be equipped with all the correct protective equipment required for the task being performed.

A qualified person is one who has the skills and knowledge related to the construction, installation and operation of electrical equipment and has received safety training to recognize and avoid the hazards involved.

Except when it is imposed, the wearing of the gloves has been voluntarily limited in this manual so as to have clear visuals of the hands and operations described.

For each operation, it is mandatory to use safety equipment appropriate:

- Personal Protective Equipment (PPE)
- Collective Protection Equipment (CPE)



Eye protection must be worn

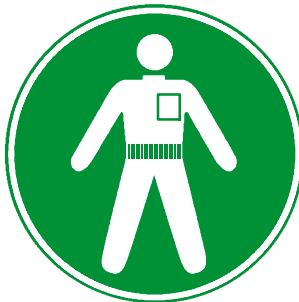

Safety overalls must be worn



Safety boots must be worn



Safety gloves must be worn



Safety helmet must be worn



Ear protection must be worn

1.3 Cleaning instructions



CHEMICAL SOLVENT AND ALCOHOL FORBIDDEN

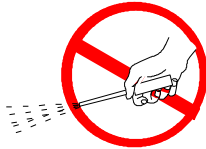

HIGH PRESSURE CLEANING PROCESS FORBIDDEN

1.4 Symbols of information



Code for a product recommended and marketed by Schneider Electric



Tightening torque value
Example: 21 Nm



Mark corresponding to a key

1.5 Symbols and important safety informations

The following special messages may appear throughout this bulletin or on the equipment to warn of potential hazards or to call attention to information that clarifies or simplifies a procedure.



DANGER indicates an imminently hazardous situation which, if not avoided, **will result in** death or serious injury.



WARNING indicates a potentially hazardous situation which, if not avoided, **can result in** death or serious injury.



CAUTION indicates a potentially hazardous situation which, if not avoided, **can result in** minor or moderate injury.



NOTICE is used to address practices not related to physical injury. The safety alert symbol shall not be used with this signal word.

1.6 Contacts

Group Schneider Electric service centers are there for:

- J Engineering and technical assistance
- J Commissioning
- J Training
- J Preventive and corrective maintenance
- J Spare parts
- J Adaptation work

Schneider Electric Energy France

35 rue Joseph Monier - CS 30323

F-92506 Rueil-Malmaison Cedex

www.schneider-electric.com

2.1 Other technical manuals to be consulted

J	AMTNoT131-02	FBX SF6	Installation - Commissioning
J	AMTNoT142-02	FBX	Replacement of a manometer
J	AMTNoT153-02	FBX	Mechanical key-type interlocking - Assembly - Operation
J	AMTNoT170-02	FBX CB & CBb	Installation - Commissioning - Operation - Maintenance
J	AMTNoT207-02	FBX	Maintenance & Replacement Manual and motorized mechanical control mechanisms for C & T1 functions
J	AMTNoT208-02	FBX	Maintenance & Replacement Manual and motorized mechanical control mechanisms for T2 function
J	AMTNoT209-02	FBX	Replacement of an auxiliary low voltage transformer
J	AMTNoT210-02	FBX	Replacement of a plug of a fuse-holder
J	AMTNoT211-02	FBX	Replacement of a voltage detection device
J	AMTNoT212-02	FBX	Replacement of a fault current indicator
J	AMTNoT213-02	FBX	Replacement of a protection relay

2.2 Tools (*not supplied*) required for the operations described in this user manual

- Flat, thin screwdriver (4) + medium
- Leather gloves



3.1 Functional mechanical interlocks

The FBX switchboard is equipped with internal mechanical interlocks, called "functional", intended to avoid any kind of operating error.

It is necessary to know these interlocks in order to operate the switchgear correctly.

CAUTION

Function S_b: The disconnection or earthing operation can only be carried out once suitably adapted lockout operations have been implemented on the network.

3.2 Interlocks for functions C and T1

	Position	Load Break Switch	Earthing switch	Access hatch to fuse electrodes or cables
Load Break Switch	Closed	-	Locked open	Locked closed
	Open	-	Free	Dependant on the position of the earthing switch
Earthing switch	Closed	Locked open	-	Free
	Open	Free	-	Locked closed
Access hatch to fuse electrodes or cables	Open	Locked open	Locked closed	-

3.3 Interlocks for functions T2 and CB

	Position	Circuit breaker	Disconnecter switch	Earthing switch	Access cover to cable compartment
Circuit breaker	Closed	-	Locked closed	Locked open	Locked closed
		-	Locked open	Free	Dependant on the position of the earthing switch
	Open	-	Free	Dependant on the position of the disconnecter switch	Dependant on the position of the earthing switch
Disconnecter switch	Closed	Free	-	Locked open	Locked closed
	Open	Free (Normally Open)	-	Free	Dependant on the position of the earthing switch
Earthing switch	Closed	Free (Normally Open)	Locked open	-	Free
	Open	Free (Normally Open)	Dependant on the position of the circuit breaker	-	Locked closed
Access panel to the cable compartment	Open	Free (Normally Open)	Locked open	Locked Closed	-

3.4 Interlocks for function CBb

	Position	Circuit breaker	Disconnecter switch	Earthing switch	Access cover to cable compartment
Circuit breaker	Closed	-	Locked closed	Locked open	Closed access with tool
		-	Locked open	Free	Closed access with tool
	Open	-	Free	Dependant on the position of the disconnecter switch	Closed access with tool
Disconnecter switch	Closed	Free	-	Locked open	Closed access with tool
	Open	Free (Normally Open)	-	Free	Closed access with tool
Earthing switch	Closed	Free (Normally Open)	Locked open	-	Closed access with tool
	Open	Free (Normally Open)	Dependant on the position of the circuit breaker	-	Closed access with tool

3.5 Interlocks for function Sb

	Position	Disconnecter switch	Earthing switch
Disconnecter switch	Closed	-	Locked open
	Open	-	Free
Earthing switch	Closed	Locked open	-
	Open	Free	-

4 Operating accessories

4.1 Reminder for Manual Operations

The operating manoeuvres are made without any special effort. Nevertheless, the force required is greater for latching controls (T1, T2, CB) than for tumbler switches (C).

All movements of the lever must be frank and complete.

The lever moves through approximately 95°.

4.2 Operating accessories



J Standard operating lever for the earthing switch (red end).



J Standard operating lever for the load-break switch (black end).



J Fuse electrode compartment key.



J Emergency manual control lever for motorised mechanisms.

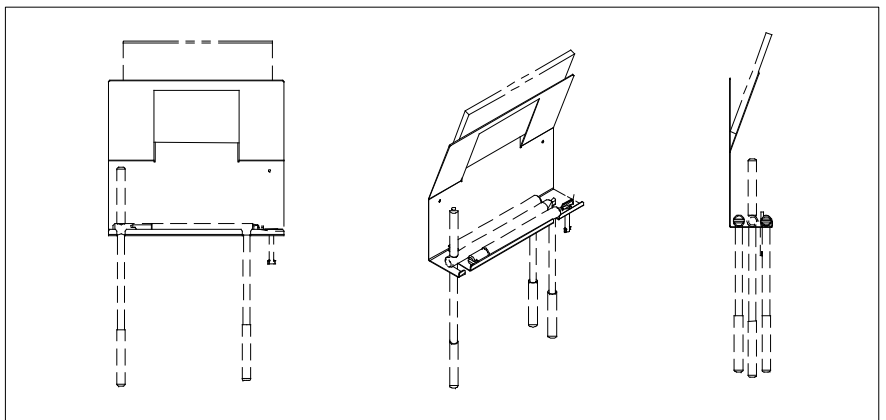

J Wall-mounted storage rack.

4.3 Lockouts using padlocks (Optional)

Optional: Each mechanical control hub can be fitted so as to allow it to be locked out using a padlock (not supplied).

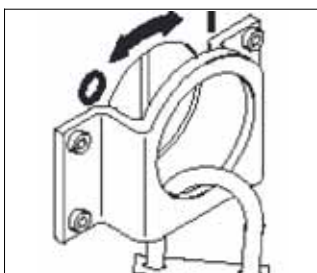

5.1 Opening the earthing switch



- J Check that the tag is fully lowered.
- J Insert the appropriate lever (red end) into the earthing switch socket.

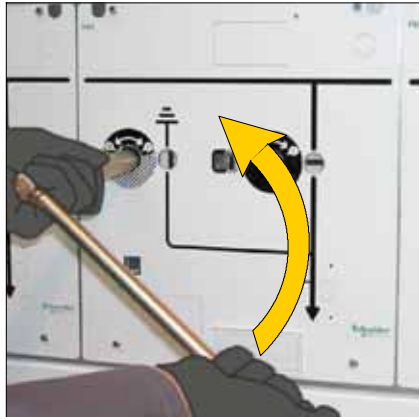

- J Grasp the lever with both hands.



- J Lift the lever: the earthing switch is now in the open position.
- J Remove the lever.

5.2 Closing the earthing switch

NOTICE

Before closing the earthing switch, ensure there is no voltage across the indicator units.

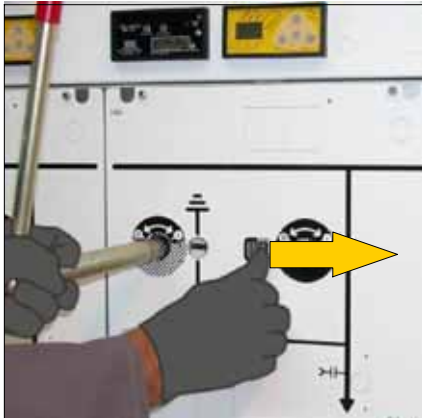

- J Check that the tag is fully lowered.
- J Hold the locking tab open to the right.
- J Insert the appropriate lever (red end) into the earthing switch socket.

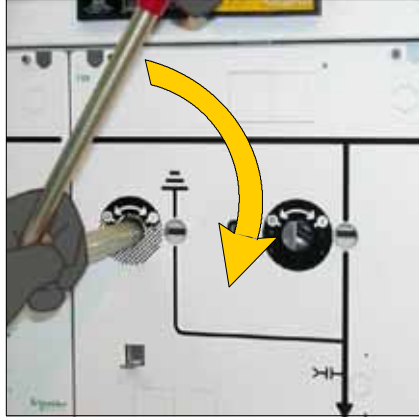

- J Grasp the lever with both hands.

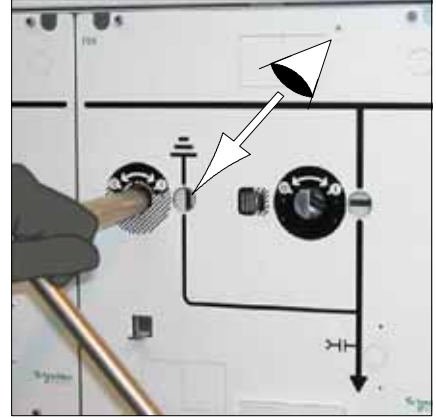

- J Pull the lever down: the earthing switch is closed.
- J Remove the lever.

5.3 Closing the load break switch



J Insert the appropriate lever (black end) into the load-break switch socket.

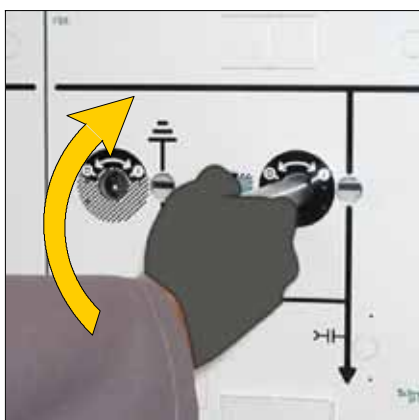

J Grasp the lever with both hands.



J Lift the lever: The switch is now closed.
J Remove the lever.

5.4 Opening the load break switch



J Insert the appropriate lever (black end) into the load-break switch socket.

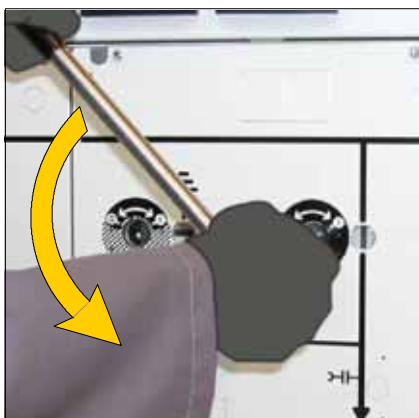

J Grasp the lever with both hands.

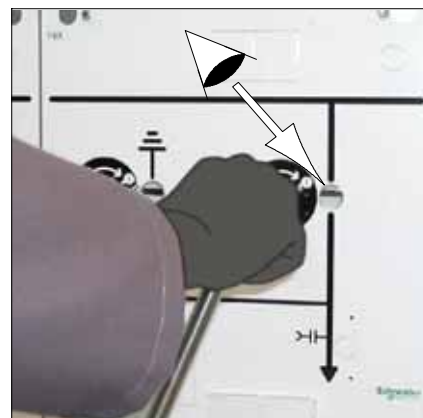

J Pull the lever down: The switch is now open.
J Remove the lever.

5.5 Operation of motorized control mechanisms

See chapter 9.

6 Use of the T1 function

6.1 Opening the earthing switch

See instructions in § 5.1.

6.2 Closing the earthing switch

See instructions in § 5.2.

6.3 Closing the load break switch



- J Insert the appropriate lever (black end) into the load-break switch socket.
- J Grasp the lever with both hands.

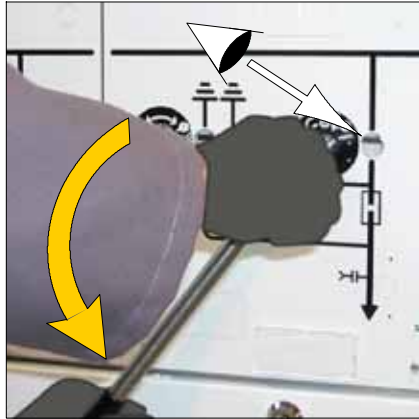

- J Lower the lever to its lowest position and release slowly (to ensure that the latch is engaged): The switch is now held permanently open.

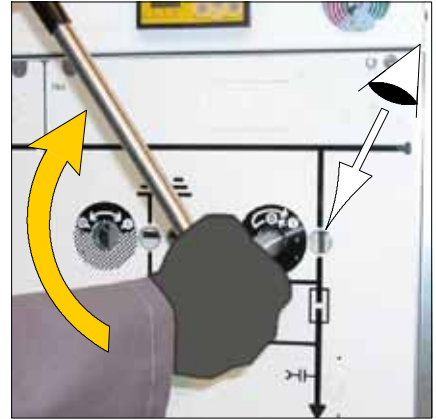

- J Lift the lever fully: The switch is now closed.
- J Remove the lever.

6.4 Manually opening the load break switch

NB: The switch can also be opened using a push-button (optional) or an electrical control.

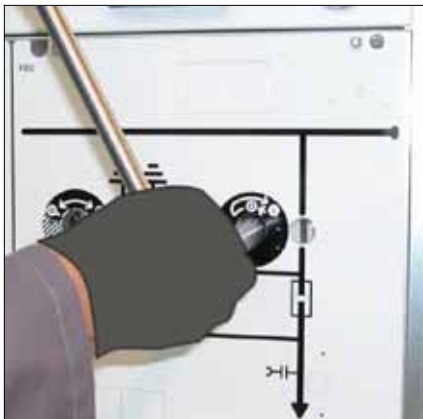

- J Insert the appropriate lever (black end) into the load-break switch socket.



- J Grasp the lever with both hands.

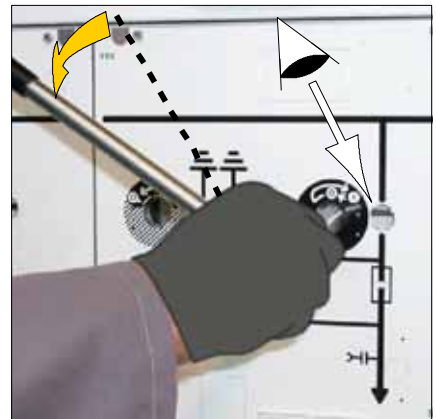

- J Lower the lever through approximately 20°: The switch is now open.
- J Remove the lever.

6.5 Operation of motorized control mechanisms

See chapter 9.

7.1 Opening the earthing switch

See instructions in § 5.1.

7.2 Closing the earthing switch

See instructions in § 5.2.

7.3 Closing the line isolating switch [circuit breaker open]

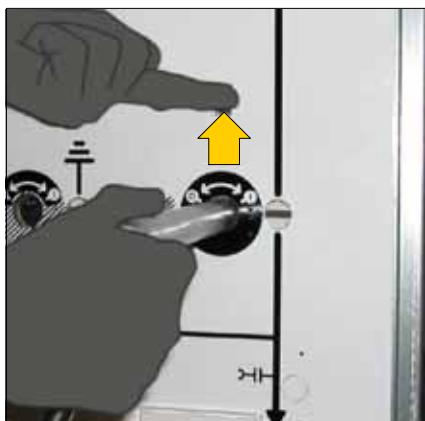

- J Lift the locking tab.
- J Insert the appropriate lever (black end) into the disconnecter switch socket.



- J Grasp the lever with both hands.



- J Lift the lever: The line isolator is now closed.
- J Remove the lever.

7.4 Opening the line isolating switch [circuit breaker open]

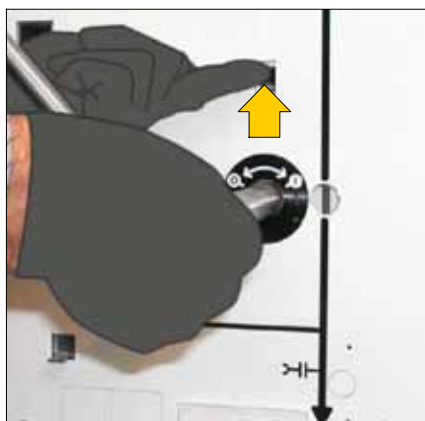

- J Lift the locking tab.
- J Insert the appropriate lever (black end) into the disconnecter switch socket.



- J Grasp the lever with both hands.

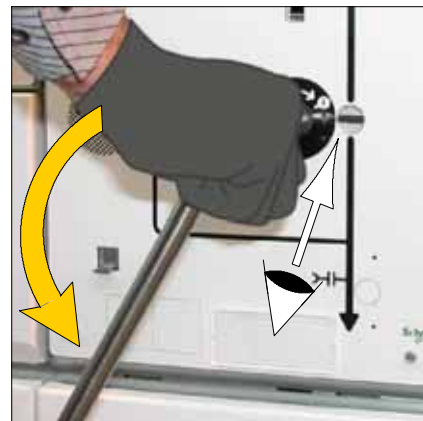

- J Pull the lever down: The line isolator is now open.
- J Remove the lever.

7.5 Closing the circuit breaker [Line Isolator closed]



- J Insert the appropriate lever (black end) into the circuit breaker socket.
- J Grasp the lever with both hands.



- J Lower the lever to its lowest position and release slowly (to ensure that the hold-open latch is engaged): The switch is now held permanently open.

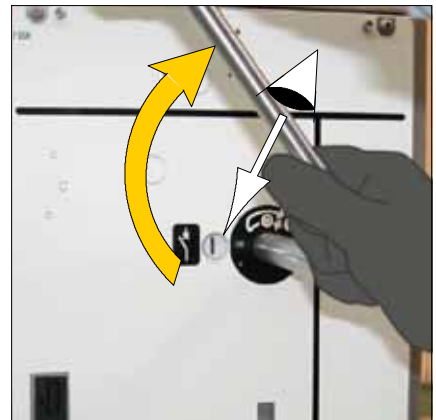

- J Lift the lever fully: The circuit breaker is now closed.
- J Remove the lever.

7.6 Opening the circuit breaker [Line Isolator closed]

NB: The switch can also be opened using a push-button (optional) or an electrical control.



- J Insert the appropriate lever (black end) into the circuit breaker socket.



- J Grasp the lever with both hands.

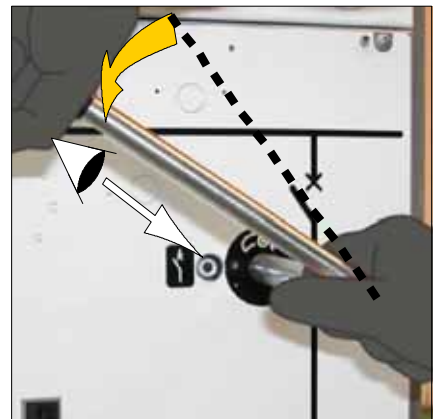

- J Lower the lever through approximately 20°: The circuit breaker is now open.
- J Remove the lever.

7.7 Closing the circuit breaker [Line Isolator open]

It is also possible to operate the CB when the line isolator is open.

This 'no-load' operation can be used to test and ensure that the circuit breaker is functioning correctly.

7.8 Operation of motorized control mechanisms

See chapter 9.

8.1 Opening the earthing switch

Follow the instructions given in § 5.1.

8.2 Closing the earthing switch



Follow the instructions given in § 5.2.

The disconnection or earthing operation can only be carried out once suitably adapted lockout operations have been implemented on the network.

NOTICE

Before closing the earthing switch, ensure there is no voltage (or current) across the circuit.

8.3 Closing the load break switch

Follow the instructions given in § 5.3.

8.4 Opening the load break switch

Follow the instructions given in § 5.4.

8.5 Operation of motorized control mechanisms

See chapter 9.

9.1 Operation of motorized control mechanisms [Optional]

If the FBX switchboard is fitted with motorized controls (optional), the various functions can be energised/de-energised remotely in accordance with the circuit diagram supplied as part of the contract.

For functions T1, T2 CB and CBb, opening operations can also be triggered by a push-button (optional) or electrical controls.

CAUTION

Function Sb: The disconnection or earthing operation can only be carried out once suitably adapted lockout operations have been implemented on the network.

9.2 Manual emergency operation of motorized controls

In the event of an outage of the motor supply source, a back-up control can be used to complete an operation underway or to carry out manual operations.

The position of the indicators should be verified after each operation.

If the supply is re-established whilst the handle is inserted, it will be pushed out of the socket.

NOTICE

When the earthing switch is closed the backup manual control lever cannot be fitted (Except for T2 circuit breaker).

9.3 Approximate number of turns for backup manual control levers

	Switch Disconnecter		Circuit breaker	
	To Open	To Close	To Open	To Close
Functions C and Sb (See § 8)	31 turns	31 turns		
Function T1	7 turns	50 turns		
Function T2	31 turns	31 turns	7 turns	50 turns

9.4 Manual interventions involving Functions C, T1 and Sb [Earthing switch open]

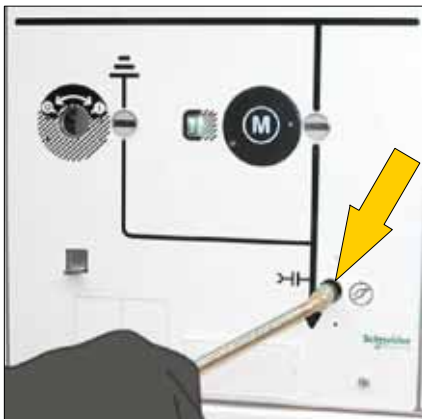

J Insert the backup handle for the switch into its hole.

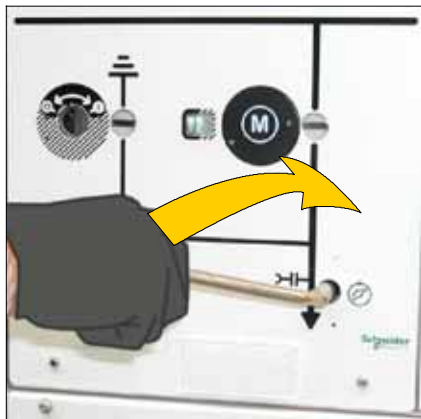

J To open (or close) the load-break switch, turn clockwise (See § 9.3).



J Continue until the operation is completed (mimic diagram changes).
J Remove the crank handle.

9.5 Manual interventions involving Function T2 [Earthing switch open]

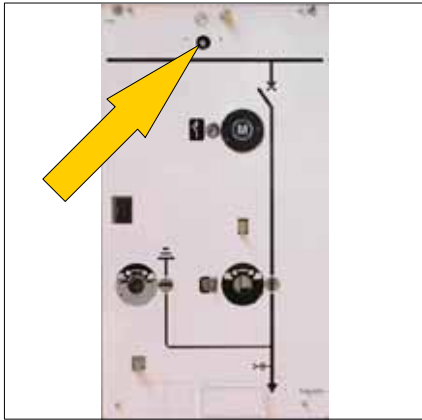

J Insert the backup handle for the switch into its hole.

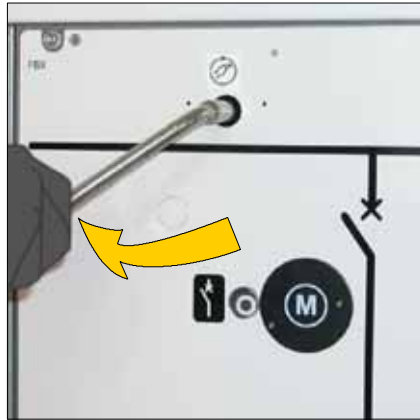

J To open (or close) the load-break switch, turn clockwise (See § 9.3).

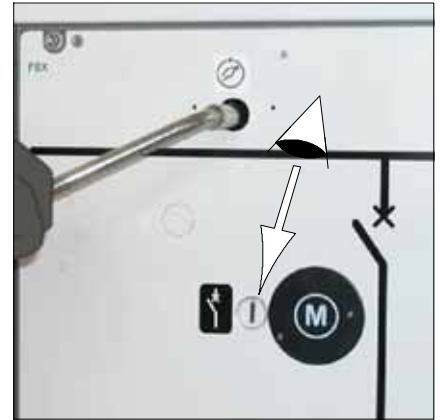

J Continue until the operation is completed (mimic diagram changes).
 J Remove the crank handle.

10.1 Levels of maintenance

Description	Levels
Operations recommended in the instructions manual "installation - operation - maintenance", carried out by suitably qualified personnel having received training allowing them to intervene whilst respecting the safety rules.	1
Complex operations, requiring specific expertise and the implementation of support equipment in accordance with Schneider Electric's procedures. These must be carried out by Schneider Electric or by a specialised technician trained by Schneider Electric when starting the procedures, with the appropriate specific equipment.	2
All preventive and corrective maintenance, all renovation and reconstruction work is carried out by Schneider Electric.	3

10.2 Preventive maintenance

PREVENTIVE MAINTENANCE	Frequency	Levels		
Recommended operations	6 years	1	2	3
Verification of the presence and condition of accessories (levers, etc.)	X	X	X	X
Visual inspection of the exterior (cleanliness, absence of oxidation, etc.)	X	X	X	X
Cleaning of external elements, with a clean, dry cloth.	X	X	X	X
Verification of the positioning of the status indicators (open and closed)	X	X	X	X
Verification of the functioning of the mechanical control mechanism by making several manoeuvres	X	X	X	X
Visual surveillance of the general appearance of connections	X	X	X	X

10.3 Corrective maintenance

CORRECTIVE MAINTENANCE	Levels			
Replacements or modifications	See §	1	2	3
Replacement of the three fuses	10.4	X	X	X
Replacement of a voltage indicator unit [E.g.: Type VPIS]	10.5	X	X	X

10.4 Replacement of the three fuses

Intervention	Busbar	Cables	Load Break Switch	Earthing switch
Normal	de-energized	de-energized	open	closed
Possible	energized	de-energized	open	closed

Locking out the Functional Unit

All locking-out operations must be performed according to the particular rules for the network concerned.

Tools required:

- Leather gloves
- Compartment key
- Small, flat-headed screwdriver

Parts required:

- 3 fuses with the same reference
(verify values in accordance with the transformer power)

NOTICE

See the corresponding chapter in the Installation Manual for the characteristics of the fuses (See § 2.1).

Replacement of a fuse



For an apparently single phase fault, it is **imperative** that all 3 fuses be replaced.



The body of a fuse can become very hot following a short circuit. Take standard precautions (leather gloves) before starting work.



Whenever changing or fitting a fuse, close the compartment immediately afterwards to avoid letting dust and humidity enter.



- J Ensure that the function's earthing switch is closed.
- J Open the compartment using the corresponding key.

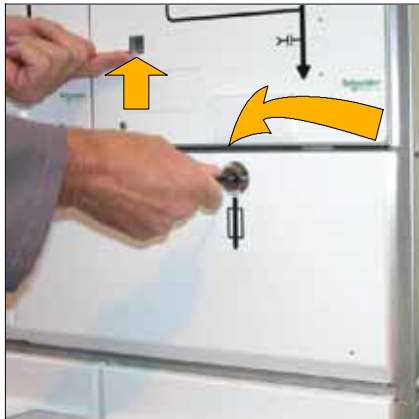

- J Lift the latch and open the panel.



- J The end plugs on the fuse holders are now accessible.



- J Use clean leather gloves.
- J Pull the fuse and plug towards you without twisting.



CAUTION

Slowly remove the plug/fuse assembly. Caution! this may be hot.

- J Place the assembly on a clean, flat surface.



- J Unscrew the fixing screw.
- J Remove the blown fuse from the plug.

NOTICE

For fuses of up to 12kV, recover the adapter plugged onto the back of the fuse.

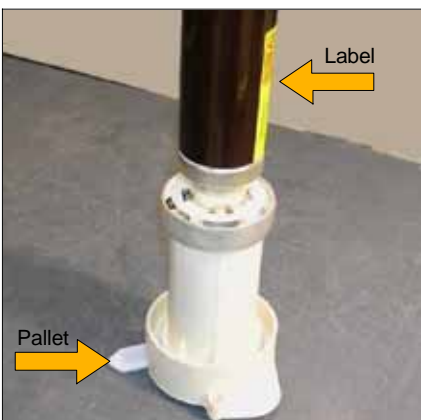

- J Fit the replacement fuse:
 - Label and emboss the plug side,
 - Label opposite to the pallet of the fuse holder.

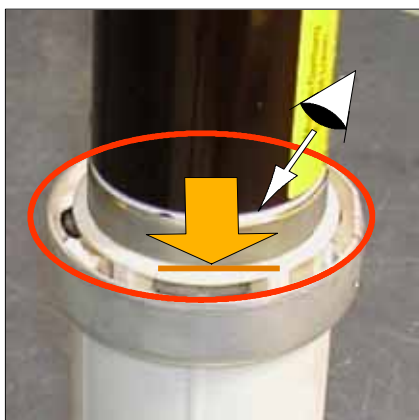

- J Insert the fuse into the clamps as far as possible, against the supporting ring.

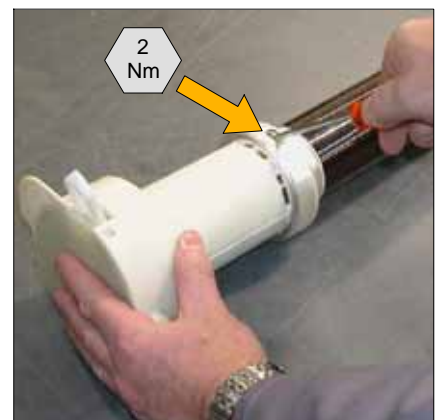

- J Place the assembly on a flat surface to make it easier to tighten the clamp collar screw to the required torque.



J For fuses of up to 12 kV: Fit an adapter onto the other end of the fuse.



J Make sure the fitted assembly (plug and fuse) is clean.

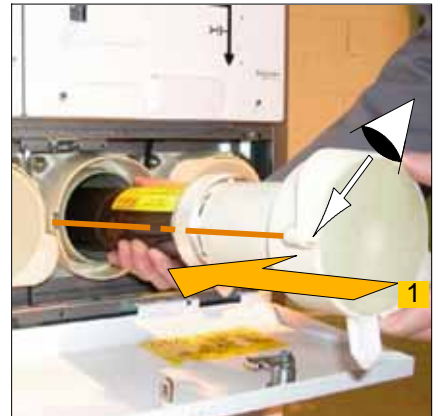

J 1. Slide this assembly into the fuse holders, aligning the lug on the plug with the slot in the holder.

CAUTION

Do not twist the assembly when inserting.

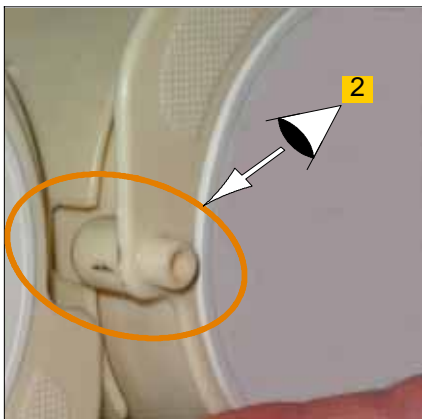

J 2. The lug on the plug must click into the slot in the fuse holder.

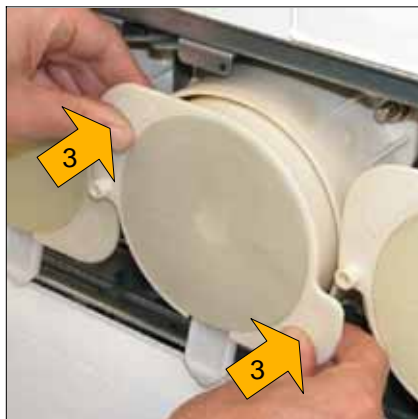

J 3. Push the plug, by the two tabs provided, up to the stop.

J Now fit the other two fuses.



J To re-close the fuse cover:
 - Lift the latch,
 - Lift the cover and push back into place,
 - Lock the cover (using the key).

Processing old fuses and packaging

NOTICE

Fuses and packaging must be disposed of via General Industrial Waste channels.

10.5 Replacement of a voltage indicator unit [E.g.: Type VPIS]

Intervention	Busbar	Cables	Load Break Switch	Earthing switch
Normal	de-energized	de-energized	open	closed
Possible	energized	energized	closed	open

<p>Locking out the Functional Unit All locking-out operations must be performed according to the particular rules for the network concerned.</p>	<p>Tools required: - Flat headed screwdriver</p>	<p>Parts required: - VPIS Indicator Unit</p>
-------------------------------------------------------------------------------------------------------------------------------------------------------------	-------------------------------------------------------------	---------------------------------------------------------



J Unscrew the two side screws (flat headed screwdriver).



J Extract the voltage indicator unit.



J Connect a new unit.
J Lightly tighten the fixing screw.

10.6 Periodic frequency for maintenance operations of the VDS boxes

- J In the immediate proximity of the voltage taps, a rating plate mentions the date of the last maintenance testing procedure.



11 Policy for Adaptation and Replacement of Schneider Electric

11.1 Definitions

Spare part is a part that is designed to replace an existing one with a view to re-establishing or maintaining the original function.

PAR (Policy for Adaptation and Replacement) is a technical manual which setting out in detail the Schneider Electric policy for the supply and replacement of spare parts for the purposes of maintenance, adaptation or renovation.

FAR is a technical notice or leaflet setting out the spare part replacement procedure for the purposes of maintenance, adaptation or renovation.

11.2 Different categories of spare parts [according to NF EN 13306 - NF X 60-319]

Consumable	Use
Wearing parts, designed to be replaced after a predetermined number of uses.	Maintenance stock, required to ensure optimum maintenance operations for 6 years.
Spare part	Use
Part designed for unscheduled replacement but with a lifetime that may be reduced through particular conditions of use.	Safety stock of spare parts replaced during corrective maintenance.
Spare part for exceptional purposes	Use
Spare part that is normally not necessary during the lifetime of a product.	Safety stock of spare parts or sub-assemblies replaced during urgent corrective maintenance.

11.3 Supply of spare parts

Individual supply	Use
Spare part ordered occasionally by the customer.	Specific need due to an accident or the destruction of the original part.
Supplied on commissioning	Use
All parts supplied at time of commissioning	Preventive stock of spare parts replaced during installation of panel.
Supplied on Short list	Use
All parts supplied for first maintenance procedure.	Maintenance stock, required to ensure optimum maintenance operations for 6 years.
Supplied on List	Use
All parts or sub-assemblies stocked on customer site.	Safety stock of spare parts or sub-assemblies replaced during urgent corrective maintenance.

11.4 Identification and storage of the parts

NOTICE

For all orders for spare parts, it is necessary to enclose the equipment characteristics form.

The components should be stored away from dust, humidity and the sun. In order to facilitate their retrieval, they must be marked by the Schneider Electric reference number.

Certain components are fragile, they should preferably be stored in their original factory packaging.

11.5 Presentation of the PAR

Intervention	What for?	Where?
Replacement	Standard exchange or part replacement	Customer site
Adaptation	Modification or installation of sub-assembly in kit format	Customer site
Modification	Modification, transformation or improvement often in an upgrade cycle	Customer site
Renovation	Technological upgrade requiring suitable knowledge and tools	Schneider Electric site

Illustrated example of PAR

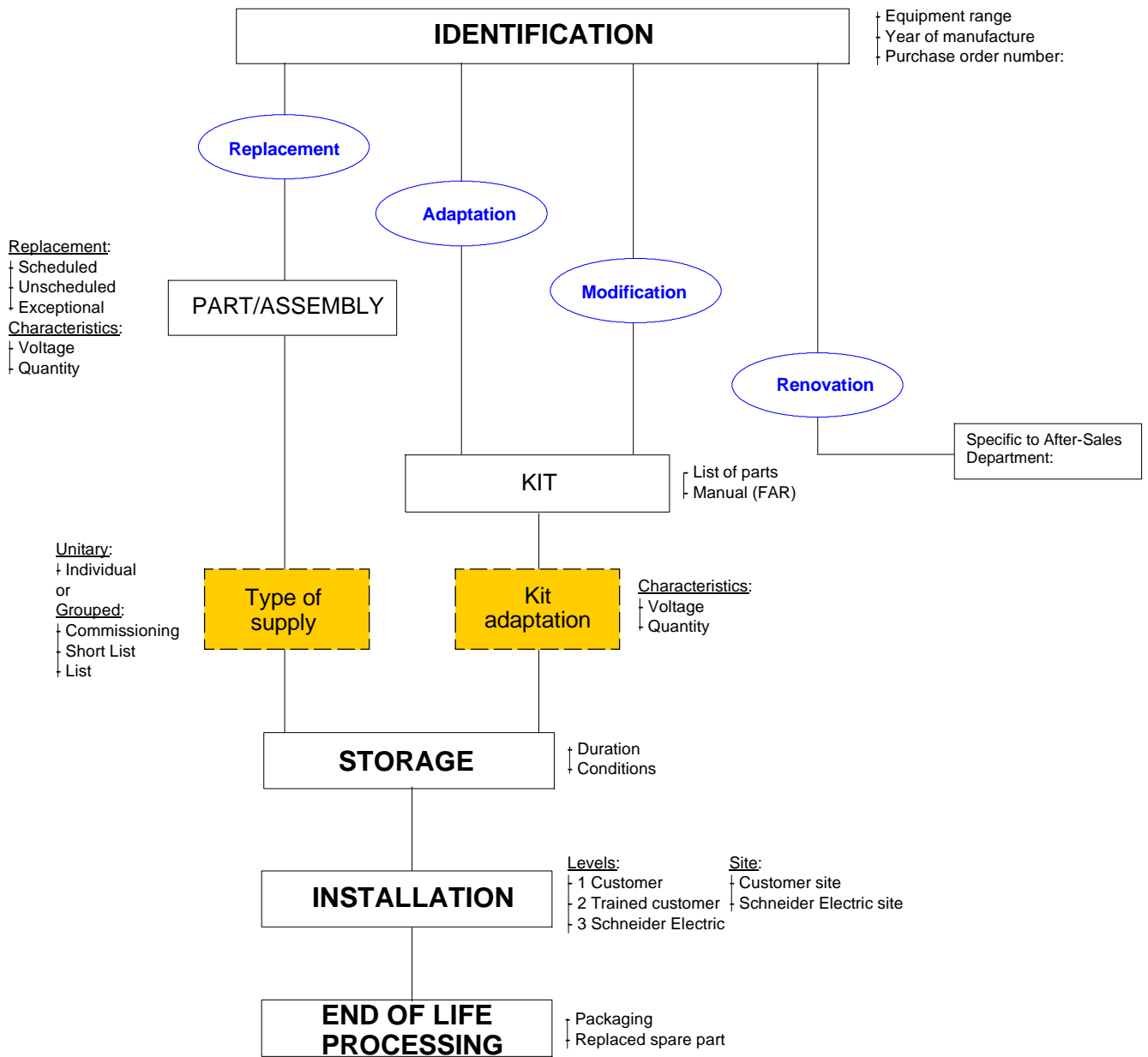

11.6 Reuse or waste processing of replaced parts and packaging

NOTICE

Waste parts, sub-assemblies and packaging are to be removed through approved waste collection and processing channels.

12.1 Preparation of the function

NOTICE

Implement lockout rules in accordance with the regulations specific to each network.

De-energize the loadbreak switch and close the earthing switch (See corresponding chapter).

Remove the cable compartment access panel.

12.2 Cable testing with plug-in 'T' piece connectors (busbar energized)

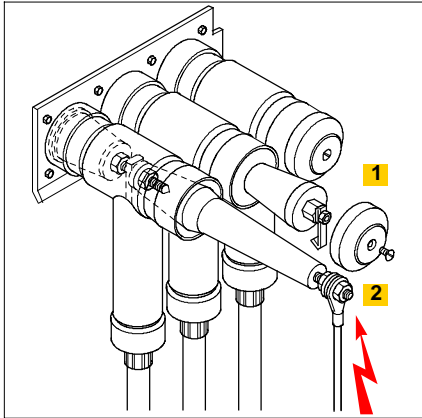

- J 1. Remove the end panel cover.
- J 2. Fit the test adapter.

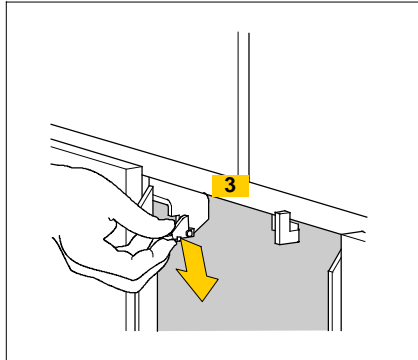

CAUTION
WARNING

Simulate the presence of the door.
J 3. Push the lock downwards: The earthing switch is now unlocked.

DANGER

In this position, the switch can be moved, unless the switchboard is fitted with an additional interlock between the cable panel and the load break switch (optional).

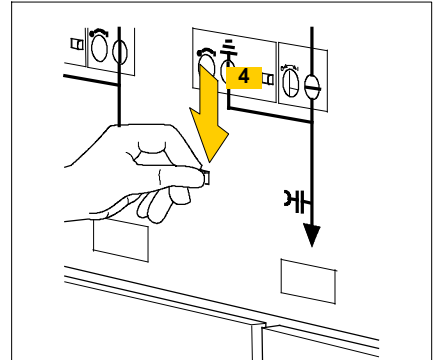

CAUTION

- J 4. Lower the locking tab.
- J Open the earthing switch (See § 5.1).
- J Proceed with the tests.

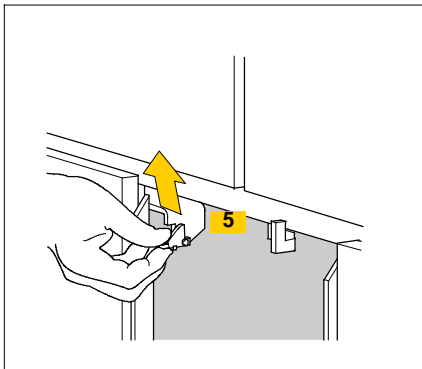

CAUTION

- J Close the earthing switch (See § 5.2).

CAUTION

- J 5. Pull the lock upwards.

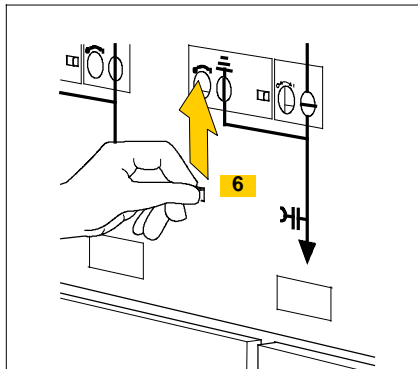

CAUTION

- J 6. Raise the unlocking latch by hand.



- J Remove the adapters.
- J Screw the covers onto each extremity.
- J Re-fit the cable compartment panel.

12.3 Cable tests: EON specification with plug-in 'T' piece connectors [busbar energized]

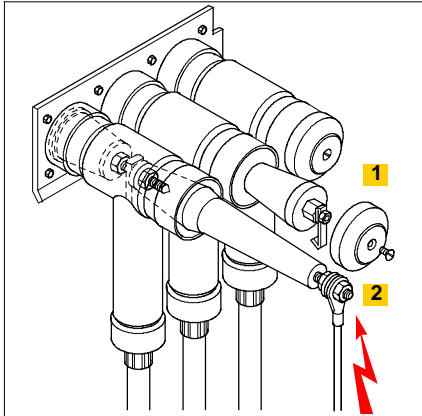

- J 1. Remove the end panel cover.
- J 2. Fit the test adapter.

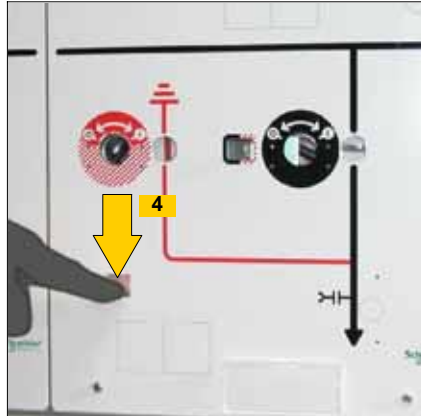

- J 3. Lower the unlocking latch by hand.

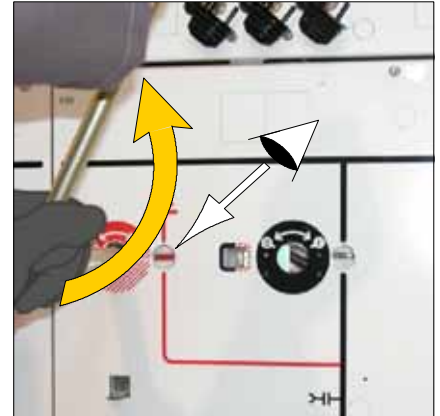

- J Open the earthing switch.
- J Proceed with the tests.

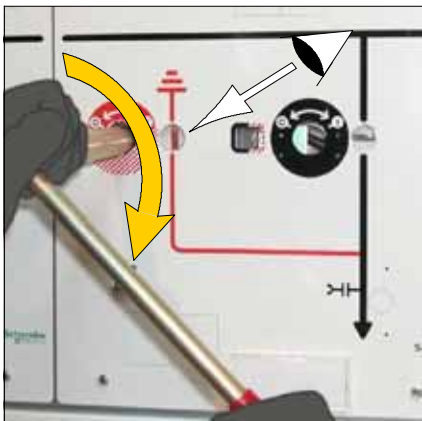

- J Close the earthing switch.

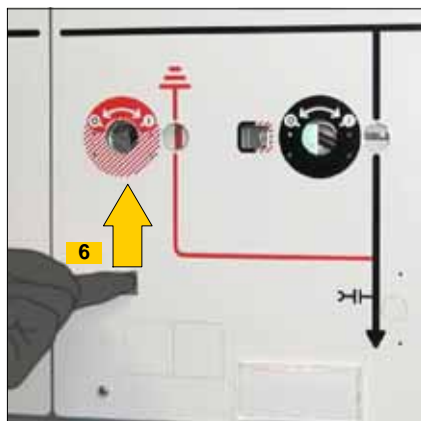

- J 6. Raise the unlocking latch by hand.



- J Remove the adapters.
- J Screw the covers onto each extremity.
- J Re-fit the cable compartment panel.

12.4 Testing the casing of plug-in connectors

Consult the supplier of the plug-in connectors for all information and figures relating to such a test.

- J To carry out this test:
 - . Shut down the function.
 - . Close the earthing switch.
 - . Disconnect the earthing braid.
- J Current injection is via the braid.
- J After the test, re-connect the earthing braid to the general earthing circuit.

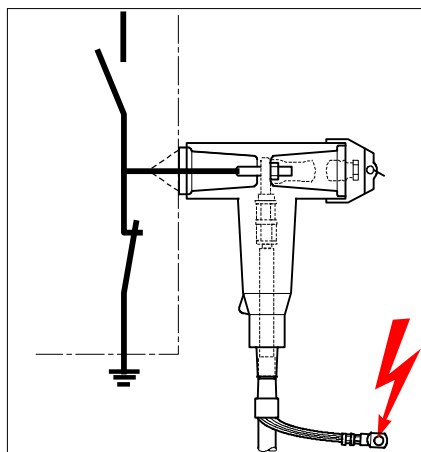

13 Characteristics and Volumes of SF6 gas

13.1 General characteristics

Type of Insulating Gas:
Sulphur Hexafluoride (SF6) – iaw IEC60376.
Each switchboard comprises a tank, filled with SF6 gas, designed as a pressurised, sealed-unit system in accordance with the requirements of IEC62271-1.

During the expected operating life and under normal operating conditions the gas should not need topping up.

! DANGER
Never pierce the pressurised tank!

! DANGER
Never attempt to open the tank.

13.2 Filling pressure

J At 20°C the filling pressure is 0.030 MPa (0.13 MPa absolute).

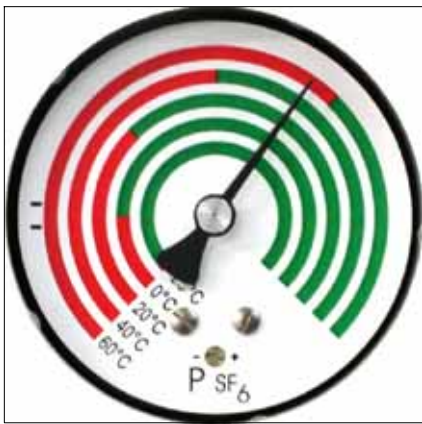

J A pressure gauge (on option) enables the SF6 gas pressure to be ensured, depending on the temperature (5 curves).



J The 2 black lines (on the left), correspond to an internal pressure equal to the atmospheric pressure (0.1 MPa absolute).



J Specific manometer (optional) for altitudes higher than 1000 m.

13.3 Operating thresholds of the pressure gauge contacts

Thresholds	Temperature	Pressure
High	20°C	250 ± 30 mbar
Low	20°C	140 + 50 mbar

13.4 FBX functions

The loadbreak switches can only be operated whilst the needle is in the green sector (to the right) corresponding to ambient temperatures.

In case of an anomaly observed (needle in the red, for example), please contact your nearest Schneider Electric representative.

14 At the end of the equipment's operational life

14.1 Valorization of the equipment

Our Functional Units are composed of recyclable elements.

The tables (§ 14.4) give information and figures for the types of materials, their quality and their methods of valorization.

They enable the following:

- Calculation to be made of the capacities for valorization,
- Optimising the valorization process,
- Evaluating the cost of valorization.

The indications given in tables (§ 14.4) facilitate co-operation between users and Schneider Electric to valorize the product at the end of the product's service life.



14.2 Safety instructions

!₁ Do not dismantle the mechanical control mechanism springs without the releasing device.

!₂ Never attempt to open the sealed-tank of a Functional Unit.

!₃ Don't try to recuperate the SF₆, without specific tools and out of a local dedicated to that operation.

14.3 Dismantling of the equipment service

Consult Schneider Electric for all decommissioning services.

! CAUTION

Recovery the SF₆, and opening the tank can be realized only in a specific room, equipped for this type of service.

14.4 Distribution and valorization of the materials used for FBX (See § 14.1)

Total weight: FBX-C (IS) C-C-T1 + 3 fuses = **310.53 kg**.

Metals – incl. inserts	Weight (kg)	% of Materials	Valorization
Steel	155.81		Yes
Stainless steel	83.85		
Copper and copper-based alloys	26.5		
Aluminium and aluminium alloys	9.8		
Silver	0.05		
Total	276.01	88.88	

Thermosetting parts	Weight (kg)	% of Materials	Valorization
Epoxy Resin*	12.14		Cannot be valorized (sent to Technical Burial Centres)
Total	12.14	3.91	

* mainly silica

Thermo-plastics	Weight (kg)	% of Materials	Valorization
Polyesters	7.33		Yes
Aromatic polyamides	2.96		
Polyamides	1.19		
Others	0.15		
Total	11.64	3.75	

Elastomers	Weight (kg)	% of Materials	Valorization
EPDM	0.09	0.03	Cannot be valorized

Gas	Weight (kg)	% of Materials	Valorization
SF6	2.57	0.83	Yes (regeneration)

Others	Weight (kg)	% of Materials	Valorization
Silica	3.00		Yes
Porcelain	2.99		
Cordierite	1.09		
Sodium Aluminosilicate	0.50		
Phenolic paper	0.43		
Grease	0.05		
Total	8.07	2.60	

If you have any comments on the use of this document or on the use of the equipment and services that are described in it, please send us your remarks, suggestions and wishes to:

Schneider Electric Technical Department BP 84019 F-71040 Mâcon Cedex 9 - FRANCE

Fax: 33 (0)3 85 29 36 36

Schneider Electric Energy France

35, rue Joseph Monier
CS 30323
F - 92506 Rueil-Malmaison Cedex

RCS Nanterre 511 746 356
Capital social 6 909 620 €
www.schneider-electric.com

Due to possible changes in standards and equipment, the characteristics and images shown in this document can only be confirmed by contacting our departments.

Publication: Schneider Electric
Design: Schneider Electric