



# 24/7

## Power availability and reliability

Learn how to prevent unexpected downtime, while keeping critical applications and buildings operating effectively

[se.com](https://se.com)

Life Is On

**Schneider**  
Electric

Tested and certified products and equipment combined with innovative solutions from Schneider Electric™ helps you to prevent downtime, monitor the status of your installation, and to recover faster in case of an outage.



# Table of contents

Introduction – Unplanned downtime	4
<b>01 Digital and power system reference designs</b>	<b>6</b>
Design process	7
Electrical installation characteristics	9
Choice of architecture	14
– Architecture assessment criteria	14
– Choice of design fundamentals	16
Choice of design details	21
– Design optimization	21
– EcoStruxure™ reference designs: hospital, data center, hotel	28
– Digital designs	30
Overview of EcoStruxure Power	31
Our Vision of a New Electric World	32
<b>02 How selectivity enhances uptime</b>	<b>34</b>
Coordination between circuit breakers	35
– Selectivity	35
– Selectivity (discrimination)	36
– Practical example of selectivity at several levels	40
Motor protection coordination	47
Different types of coordination	48
Design software	49
<b>03 Electrical asset management</b>	<b>50</b>
Operational intelligence	51
Electrical system monitoring and alarming	52
Capacity management	53
Breaker settings monitoring	54
Power quality management	55
Preventive maintenance and predictive approach	56
Digital considerations	57
<b>04 Fault localization, root cause analysis, and power recovery</b>	<b>58</b>
Fault localization, root cause analysis	59
Power event analysis for faster diagnosis of electrical problems	61
Fast outage recovery	62
EcoStruxure Power Device	63
Overview of downtime prevention devices	64
Specifying for power availability and reliability	65
Apps, analytics & services	66
Edge control	68
Connected products	72

The information provided in this Guide contains general descriptions of Schneider Electric's available range of solutions in the field of electrical systems design and specification that may address electrical power availability and reliability concerns.

This documentation is not intended as a substitute for and is not to be used for determining the suitability or reliability of these solutions for specific user applications. Schneider Electric reserves the right to make changes or updates with respect to or in the content of this Guide or the format thereof at any time without notice.

To the extent permitted by applicable law, no responsibility or liability is assumed by Schneider Electric and its subsidiaries for any errors or omissions in the informational content of this Guide, or for any damages arising out of, or in connection with the use of, or inability to use this Guide or its content, even if Schneider Electric has been expressly informed of the possibility of such damages.

# Introduction – Unplanned downtime

## The quest to ensure reliability and resilience is ongoing

### Power availability and reliability remains a major and persistent problem

No matter the industry or type of facility, downtime presents a costly risk to business continuity. Identifying electrical system vulnerabilities in order to prevent potential issues, and planning quick, effective resolutions when problems do occur are key steps to help ensure your operation is as resilient and efficient as possible.

### High cost of outages for businesses

Downtime costs can have a huge impact on an organization's bottom line.

- For data centers, the cost per minute is \$7,900 or over [\\$740k](#) per event on average.
  - Healthcare facilities' average downtime cost per minute is an estimated [\\$8,662](#).
  - 40% of commercial and industrial, (C&I) businesses in the U.S. reported a power outage costing more than [\\$50,000 during the last year](#), and 2% reported losses over \$2 million.
  - Vertical industries such as finance, media, manufacturing, and transportation/utility, could see downtimes costs run more than \$5 million an hour, according to one [study](#).
- A study from Gartner found that the average cost of downtime is [\\$5,600](#) per minute.
  - Depending on various factors, a report from [Avaya](#) estimates costs range from \$2,300 to \$9,000 per minute.

## Glossary

Let us clarify a couple of definitions that are often confused. Understanding these terms can help us better understand the best steps forward.

**Power availability.** The IEC defines [availability](#) as the “ability to be in a state to perform as required.” Put simply, this is uptime. Or in data center speak, the ‘number of 9s.’ For example, 99.999% uptime is five 9s, which equates to about 5 minutes of downtime per year. Uptime will be

affected by the reliability of a facility's infrastructure, and by how fast the facility can recover from an outage.

**Power reliability.** The IEC defines [reliability](#) as “the ability to perform as required, without failure, for a given time interval, under given conditions.” In other words, to ensure you have the maximum power uptime in your facility, you need your power infrastructure to operate reliably without any problems for the greatest duration possible, and that includes every component in the system.

There are many factors that can affect how reliably your electrical system runs. This includes how well the system is designed, its operating and environmental conditions, how well equipment and conditions are being monitored, and how well equipment is maintained.

In order to have a highly available system, the components of the system must be not only reliable, but the system itself or its components must also be capable to recover fast from an unexpected event.

## Outages are on the rise

Today's technology and automation dependent commercial and industrial (C&I) companies need reliable power to sustain daily operations. But according to the World Bank, [Quality of Electricity Supply](#), in many developed countries reliable power has remained static or decreased. In the case of utility supply disruptions, the leading cause is extreme weather, while for C&I facilities, the causes of outages are diverse. With electrical infrastructure becoming more complex, including decentralized power sources and more power electronic devices causing extra power quality pollution, the typical operation contains many hidden risks to dependable power availability.

## Improved availability, reliability, and safety through smart and efficient system design

In addition to improved safety, power availability is likely every electricity consumer's most basic concern. Even though International Electrotechnical Commission (IEC) standards have primarily focused on safety, electrical power availability and reliability is a major concern. In terms of electrical system design and specification, Schneider Electric provides a broad range of solutions for nearly every industry segment and their related applications.

Even though a well-designed electrical system is crucial to safeguarding high availability, the selectivity (i.e., the coordination or discrimination of operating characteristics between two or more protective devices) is also a must to ensure high availability.

The IEC 60364 series states that the use of selectivity is mandatory for safety-related loads such as fire suppression systems, safety lifts, etc., to prevent a fault on one circuit from affecting the electrical supply to other circuits.

Selectivity is often required by local regulations or in specialized segments such as:

- Healthcare facilities
- Marine
- High-rise structures
- Large public buildings

Protective equipment selectivity is also highly recommended when continuity of supply is acute due to the criticality of the loads for:

- Data centers
- Transportation infrastructures
- Critical process industries

Now, with digitization accelerating, electrical installation uptime can advance even further. For instance, EcoStruxure™ Power digitizes and simplifies low and medium voltage electrical distribution systems. It provides essential data to aid the decisions that help protect people safeguard assets, maximize operational efficiency and business continuity in addition to maintaining regulatory compliance.

# \$5,600

average cost of  
downtime, per minute.

-Gartner

### **This guide will cover the four main areas of Power Availability and Reliability:**

1. Digital and power systems reference designs
2. How selectivity enhances uptime
3. Electrical asset management
4. Fault localization, root cause analysis, and power recovery

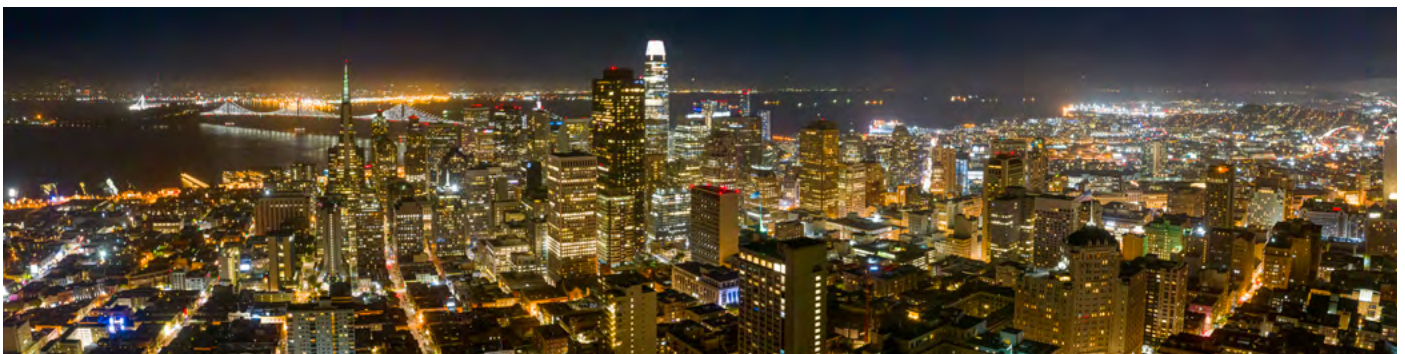

# 01 Digital and power system reference designs

Organizations depend on a robust, reliable power infrastructure to help ensure operational continuity and safety. Power system reliability and performance requirements are becoming ever more challenging, especially with the world's increasing focus on mitigating the effects of carbon-induced climate change. Microgrid, energy storage, and electric vehicle charging infrastructures are just three of the developing initiatives that could increase demand on electrical networks as well as their complexity. Fortunately, digital technologies are available to help create system configurations and equipment combinations that can harmonize with current standards and requirements.

# Design process

## Stakes of electrical architecture design

Designing electrical distribution architecture correctly is of critical importance to how the entire system performs throughout its lifecycle:

- Optimizing the network design and specifying compatible equipment can greatly reduce the installation time, effort, and technical expertise required by installers.
- Operational performance related to power quality and availability can also be greatly affected.
- End-of-life considerations are also a component of optimal design.

An efficient electrical system design should match the anticipated needs of the end user throughout all lifecycle phases. This should be done early in the design process to identify more possibilities for optimization to each customer's unique requirements.

### Simplified architecture design process

The architecture design starts at the preliminary design stage and generally covers the levels of medium voltage (MV) and low voltage (LV) main distribution, LV power distribution, plus the terminal distribution level.

In buildings, most consumers are connected to LV, meaning that MV distribution is only applicable for:

- Connection to utility service
- Distribution to MV/LV substation(s)
- MV network connection to LV substation(s) themselves

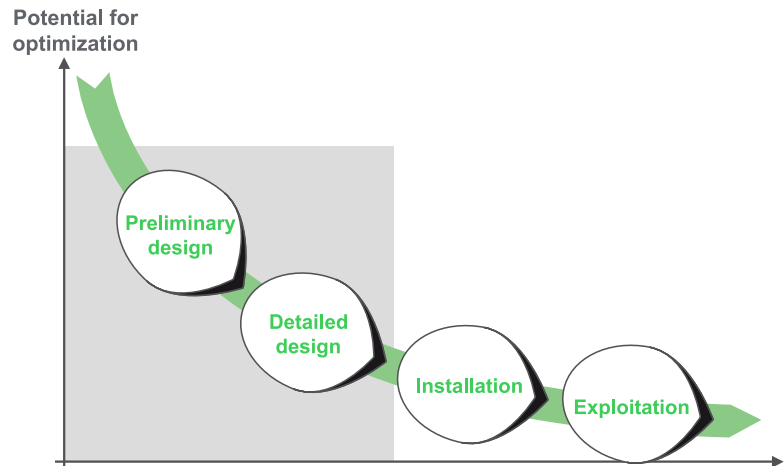

Figure 1 - Optimizational potential

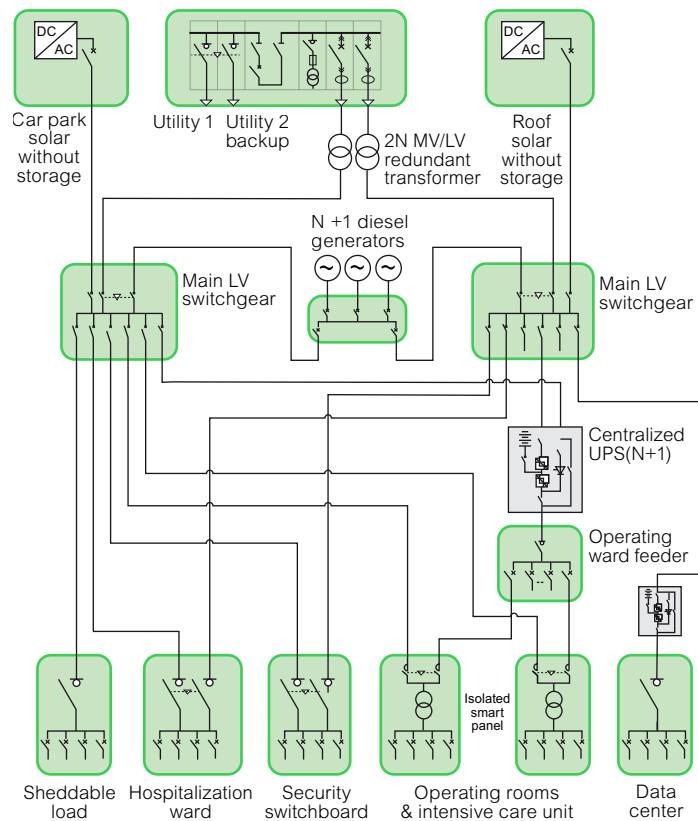

Figure 2 - Example of architecture for a medium-sized hospital

It is important to factor in the MV/LV substation into planning early in the design process due to environmental exposure concerns and to ensure maximum flexibility as power system requirements change over time. Electrical distribution architecture design can be thought of as a three-stage process, with many opportunities for continuous improvement once the specific installation characteristics and performance criteria are factored in.

### The whole process

A fully optimized electrical distribution system can more cost-effectively and safely supply a sufficient electric supply to both existing, and anticipated loads throughout the lifecycle of an installation. This involves three main steps, see **Figure 3**:

#### 1. Selecting distribution

##### architecture fundamentals

This includes classifying all the characteristics and requirements of the installation and how each element will impact the connection to the upstream network. Several distribution schematic diagram solutions may be produced, any of which can be used as the starting point for the single-line diagram.

#### 2. Choosing the system architecture details

This step requires the electrical installation be defined in greater detail and is a product of the requirements defined in step one, as well as satisfying any additional criteria related to the installation's implementation and operation. Any unsatisfied step one criteria should be resolved at this point and upon completion, a detailed single-line diagram will be produced.

#### 3. Equipment selection

Specifying the appropriate equipment for optimal network performance is carried out in this stage, and is the result of the architecture chosen. Options are made from manufacturer catalogs to adequately meet relevant criteria.

An architecture assessment process allows the design office to have data to support any additional discussions with customers and stakeholders.

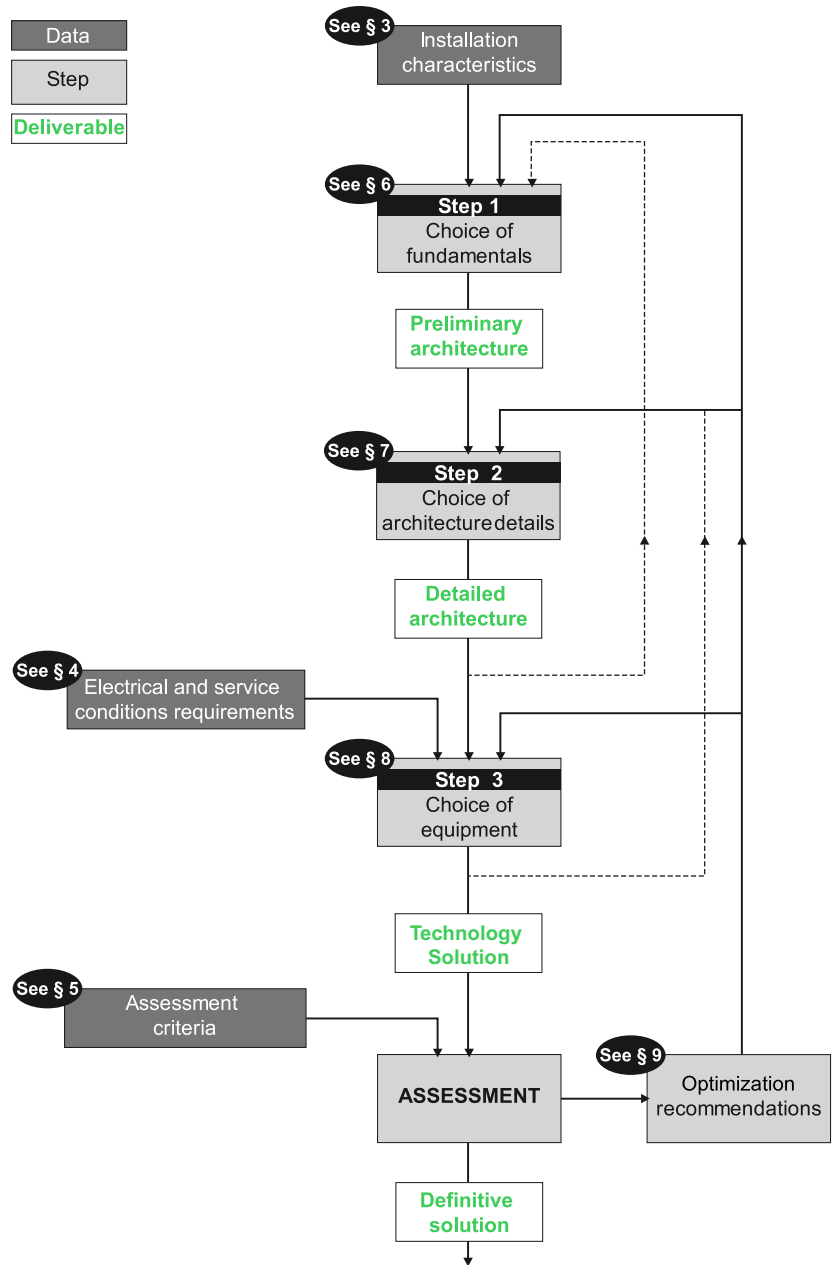

Figure 3 – Flow diagram for choosing the electrical distribution architecture



# Electrical installation characteristics

The fundamental details of the characteristics enabling electrical distribution architecture to be defined are:

Installation type as defined by IEC 60364-8-1 § 3.4:

- **Residential buildings** - premises designed and constructed for private habitation.
- **Commercial** - buildings designed and constructed for commercial operations.
- **Industry** - facilities designed and constructed for manufacturing and processing operations.
- **Infrastructure** - systems or premises designed and constructed for transport and utility operation.

While there are many other factors that influence the design of an electrical installation, these are the main characteristics to consider for optimum uptime of the future installation.

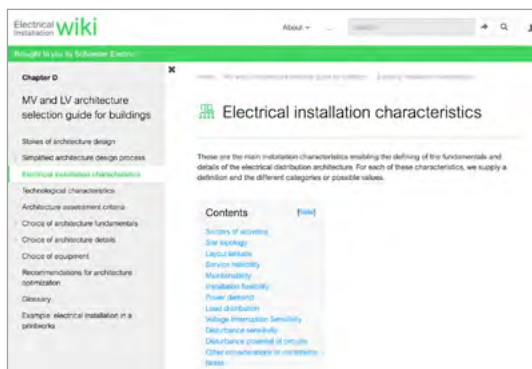

For full list visit our Electrical Installation Wiki page.

## Service reliability

Defined as the ability of a power system to meet its supply function under defined conditions for any specific period of time.

Different categories:

- **Minimum** - this level of service reliability implies the risk of interruptions related to constraints that are geographical, technical, or economic.
- **Standard**
- **Enhanced** - this level of service reliability can be obtained by special measures taken to reduce the probability of interruption.

## Maintainability

Maintainability is fundamental to safe, reliable installations and is factored into the project during the design phase in order to limit the impact of maintenance actions on all, or part, of the operation.

Different categories:

- **Minimum** - the installation must be stopped to carry out maintenance operations.
- **Standard** - maintenance operations can be performed during installation operations, but with compromised performance and should preferably be scheduled during periods of low activity.
- **Enhanced** - special measures are taken to allow maintenance operations without disturbing the installation operations.

## Installation flexibility

Installation flexibility provides the option to easily move electricity delivery points within an installation, or to simply increase the power supplied at certain points.

Different categories:

- **No flexibility** - the position of loads is fixed throughout the lifecycle due to the high constraints related to the building construction or the high weight of the supplied process.
- **Flexibility of design** - the number of delivery points, the draw of loads, or their location is not fully known.
- **Implementation flexibility** - the loads can be installed after the installation is commissioned.
- **Operating flexibility** - the position of loads will fluctuate according to process re-organization:
  - Industrial building: extension, splitting, and changing usage
  - Office building: splitting

## Load distribution

Designates characteristics related to the uniformity of load distribution (in kVA / m<sup>2</sup>) and include:

- **Uniform distribution** – generally lower unit power and spread throughout the building, intermediate distribution which is generally medium power and placed in groups throughout the building and localized loads that are generally high power and localized in several areas of the building.

## Sensitivity to power outages

This is defined as the capacity of a circuit to accept a power interruption.

Different categories:

- **“Sheddable” circuit** – it is possible to shut down at any time for an indefinite duration
- **Long interruption acceptable** - interruption time > 3 minutes
- **Short interruption acceptable** - interruption time < 3 minutes
- No interruption is acceptable

We can distinguish various levels of severity of an electrical power interruption according to the possible consequences:

- No notable consequence
- Loss of production
- Deterioration of the production facilities or loss of sensitive data
- Potential for lethal danger

This is expressed in terms of the criticality of supplying loads or circuits:

- **Non-critical** - the load or the circuit can be “shed” at any time, for example, a sanitary water heating circuit.
- **Low criticality** - a power interruption causes temporary discomfort for building occupants, without any financial consequences, while prolonging the interruption can cause a loss of production or lower productivity, such as in heating, ventilation, and air conditioning circuits.
- **Medium criticality** - a power interruption causes a short interruption in a process or service, while prolonging the interruption can cause a deterioration of the production facilities or raise start back costs, such as refrigerated units, or lifts.
- **High criticality** - any power interruption that poses a lethal danger or unacceptable financial loss, for example, as in an operating theater, IT department, or security department.

## Disturbance sensitivity

Disturbance sensitivity refers to the ability of a circuit to function correctly in the presence of an electrical power disturbance. A disturbance can lead to malfunctions of varying degrees, for example, total failure, functioning incorrectly, accelerated aging, or losses increase.

Types of disturbances that have an impact on circuit operations:

- Overvoltages
- Voltage harmonic distortion
- Voltage drop, voltage dip
- Voltage fluctuation
- Voltage imbalance

Different categories:

- **Low sensitivity** - disturbances in supply voltages have very little effect on operations, for example, heating devices.
- **Medium sensitivity** - voltage disturbances that cause a notable deterioration in operations, for example, motors and lighting.
- **High sensitivity** - voltage disturbances that can cause a halt to operations or even the deterioration to sensitive equipment, for example, IT infrastructure.

A circuit's sensitivity to disturbances determines the design of shared or dedicated power circuits, as it is preferable to separate sensitive loads from loads that can cause power disturbances, for example, separating lighting circuits from motor supply circuits.



## Disturbance potential of circuits

This describes the capacity of a circuit to disrupt the operation of surrounding circuits due to occurrences such as harmonics, in-rush current, voltage imbalance, high-frequency currents, electromagnetic radiation, etc.

Different categories:

- **Non-disturbing** - no specific precautions to take.
- **Moderate or occasional disturbances** – a separate power supply may be necessary in the presence of medium- or high-sensitivity circuits, for example, in lighting circuits generating harmonic currents.
- **Highly disturbed** - a dedicated power circuit, or other methods for attenuating disturbances otherwise essential for the correct functioning of the installation, for example electrical motors with strong start-up currents or welding equipment with fluctuating currents.

## Technological characteristics:

The technological solutions under consideration involve various types of MV and LV equipment, as well as busbar trunking systems.

The choice of technological solutions can be made following the selection of a single-line diagram and according to characteristics such as:

### 1. Environment and atmosphere

It is important to account for all of the environmental constraints (e.g., average ambient temperature, altitude, humidity, corrosion, dust, impact, etc.) and consolidate protection indexes, IP and IK. Understanding and accommodating indoor service conditions help extend the lifespan of electrotechnical components.

Different categories:

- **Standard** – no specific environmental constraints.
- **Enhanced** – a severe environment with several environmental parameters that generate important constraints for the installed equipment.
- **Specific** – an explicit environment, requiring special enhancements.

### 2. Service Index

The Service Index (SI) is a dedicated electrical designer's tool that helps specify LV switchboards with references to a user's need rather than to technical aspects. It ensures the effective definition of the switchboards according to IEC 61439-1 and 2 criteria for any:

- Future evolution
- Maintenance
- Operational needs

SI has been defined by the French standard committee (AFNOR/UTE) in 2002 under the reference C63-429.

The SI is characterized by 3 levels from 1 to 3, reflecting respectively, as shown in **Figure 4**:

- Level of operation need
- Level of maintenance request
- Level of evolution request

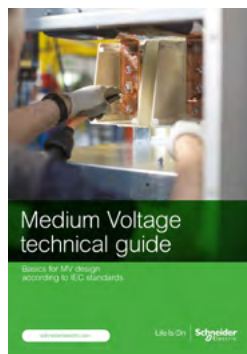

Read our [MV technical guide](#) to learn more about the impact of various conditions that should be linked to a design of an MV/LV installation.

	Operation <sup>(a)</sup> : first number	Maintenance <sup>(b)</sup> : second number	Evolution <sup>(c)</sup> : third number
Level 1	Full shutdown of the switchboard is accepted	Full shutdown of the switchboard is accepted	Full shutdown of the switchboard is accepted
Level 2	Only the shutdown of the concerned functional unit <sup>(d)</sup> is accepted	Only shutdown of the concerned functional unit <sup>(d)</sup> is accepted. But reconnection of the functional unit requests an action on connections	Only shutdown of the concerned functional unit <sup>(d)</sup> is accepted. Spare functional units are provided
Level 3	Only the shutdown of the power of the functional unit <sup>(d)</sup> is accepted (control circuits are still available)	Only the shutdown of the concerned functional unit <sup>(d)</sup> is accepted. Reconnection of the functional unit requests no actions on connections	Only shutdown of the concerned functional unit <sup>(d)</sup> is accepted. Evolution does not request pre-equipped spare functional units

a. **Operation**: set of actions on the switchboard, which can be done by non-electrician people.

b. **Maintenance**: concerns action of control, diagnostic, servicing, reparation, and refurbishment by professionals.

c. **Evolution**: adaptation of the equipment by addition of devices, increase of power demand.

d. **functional unit**: subset of a LV switchboard including all mechanical and electrical parts dedicated to a specific function like: incomer, main feeder, auxiliary, etc.

Figure 4 – Definition of service index values

### Additional considerations

Extra considerations that have an impact on the choice of technological solutions include:

- Previous experience
- Consistency with past designs or the partial use of past designs
- Standardization of sub-assemblies
- The existence of an installed equipment base
- Utility requirements
- Technical criteria - target power factor, backed-up load power, presence of harmonic generators

These considerations should be taken into account during the detailed electrical definition phase following the draft design stage.

# Choice of architecture

## Architecture assessment criteria

### Preventive maintenance level

Definition:

Number of hours and sophistication of maintenance carried out during operations in conformity with manufacturer recommendations to ensure dependable operation of the installation and maintaining performance levels (avoiding failure: tripping, downtime, etc.).

Different categories:

- Standard: according to manufacturer recommendations
- Enhanced: according to manufacturer recommendations, with a severe environment
- Specific: specific maintenance plan, meeting high requirements for continuity of service, and requiring a high level of maintenance staff competency

### Availability of electrical power supply

Definition:

This is the probability that an electrical installation be capable of supplying quality power in conformity with the specifications of the equipment it is supplying, see Figure 5. This is expressed by an availability level:

$$\text{Availability (\%)} = (1 - \text{MTTR}) / (\text{MTBF} + \text{MTTR}) \times 100$$

**MTTR** (Mean Time To Repair): the average time to make the electrical system once again operational following a failure (this includes detection of the reason for failure, its repair, and re-commissioning).

**MTBF** (Mean Time Between Failure; known as well as Mean Operating Time Between Failure MOTBF): the measurement of the average time for which the electrical system is operational and therefore enables correct operation of the application.

The different availability categories can only be defined for a given type of installation, e.g., hospitals and data centers.

#### Example of classification used in data centers:

- **Tier 1:** the power supply and air conditioning are provided by one single channel, without redundancy, which allows availability of 99.671%
- **Tier 2:** the power supply and air conditioning are provided by one single channel, with redundancy, which allows availability of 99.741%
- **Tier 3:** the power supply and air conditioning are provided by several channels, with one single redundant channel, which allows availability of 99.982%
- **Tier 4:** the power supply and air conditioning are provided by several channels, each with redundancy, which allows availability of 99.995%

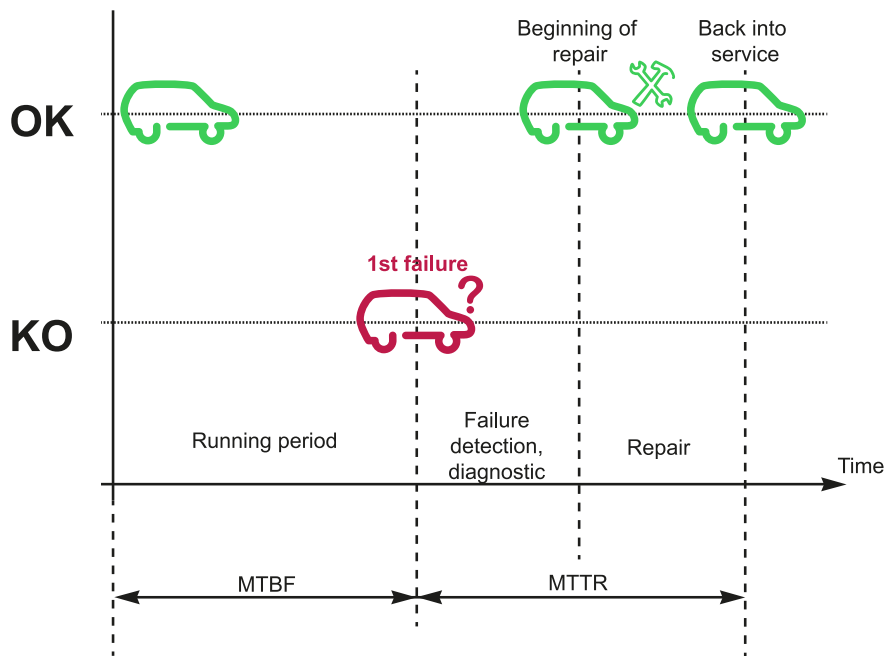

Figure 5 – D6 Definition of MTBF and MTTR



# Choice of architecture

## Choice of design fundamentals

### Two stages to selecting an electrical architecture

The **first stage** is generally dedicated to:

- The selection of the mode of connection of the installation to the utility network.
- The choice of the internal MV distribution including:
  - The definition of the number of MV/LV substations,
  - The definition of the number of MV/LV transformers,
  - The definition of the MV backup generator when needed.

The **second stage** deals with the principle of supply of the LV consumers.

### Connecting to the utility network

Factors relevant to connecting an installation to the utility network, **see Figures 6, 7 and 8**, include:

- Connecting a LV network for small and medium size installations that requires less than 400 kVA. Defining the limit is always the responsibility of the local utility managing the LV network.
- For connections to MV networks above 400kVA, using either LV or MV metering. LV metering is generally authorized for installation including a single MV/LV transformer not exceeding the rated power limit fixed by the utility, generally around 1250 kVA. The possible connections to a MV utility network include the following:
  - MV single-line service
  - MV ring-main service
  - MV duplicate supply service, including two load break switches equipped with an automatic change over.
  - MV dual supply service that provide two independent connections to the utility and two bus bars connected with a bus tie, equipped with an automatic change over.

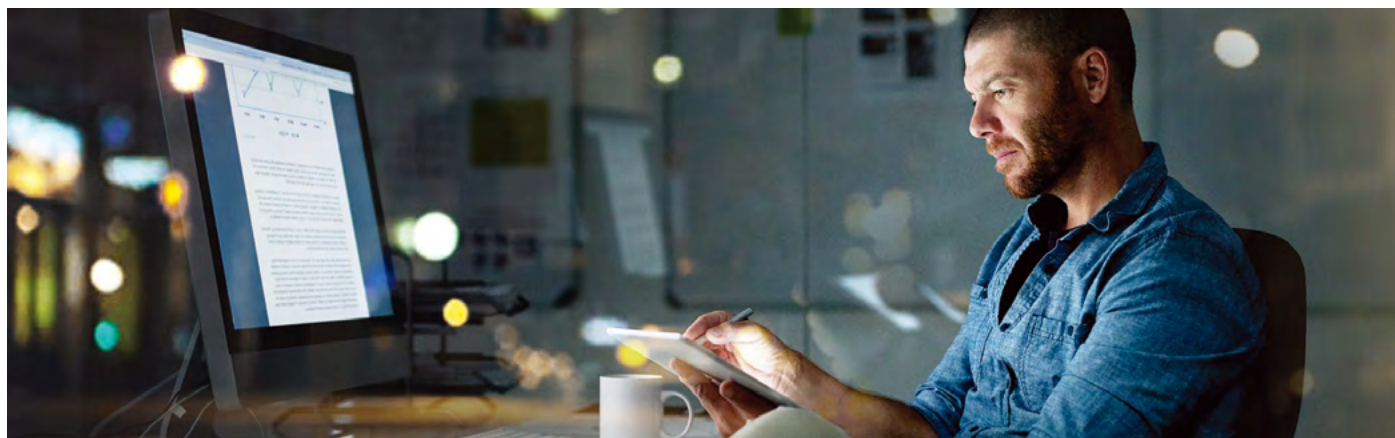



Characteristic to consider	Configuration				
	LV	MV			
		Single-line	Ring-main	Duplicate supply	Dual supply
Activity	Any	Any	Any	High tech, sensitive office, healthcare	Very sensitive installations
Site topology	Single building	Single building	Single or several buildings	Single or several buildings	Single or several buildings
Service reliability	Minimal	Minimal	Standard	Enhanced	Very high
Power demand	< 400 kVA	≤ 1250kVA	Any	Any	Any
Other connection constraints	Any	Isolated site	Low density urban area	High density urban area	Dedicated measures taken by the utility

Figure 6 – Comparison of the modes of connection

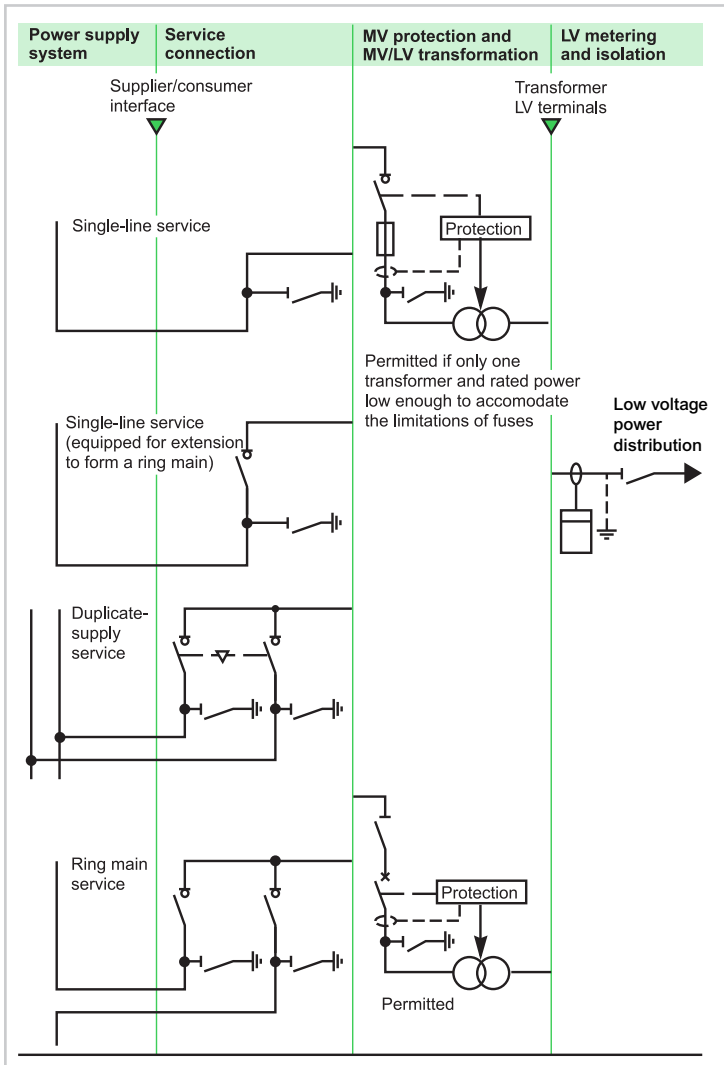

Figure 7 – MV connection with LV metering

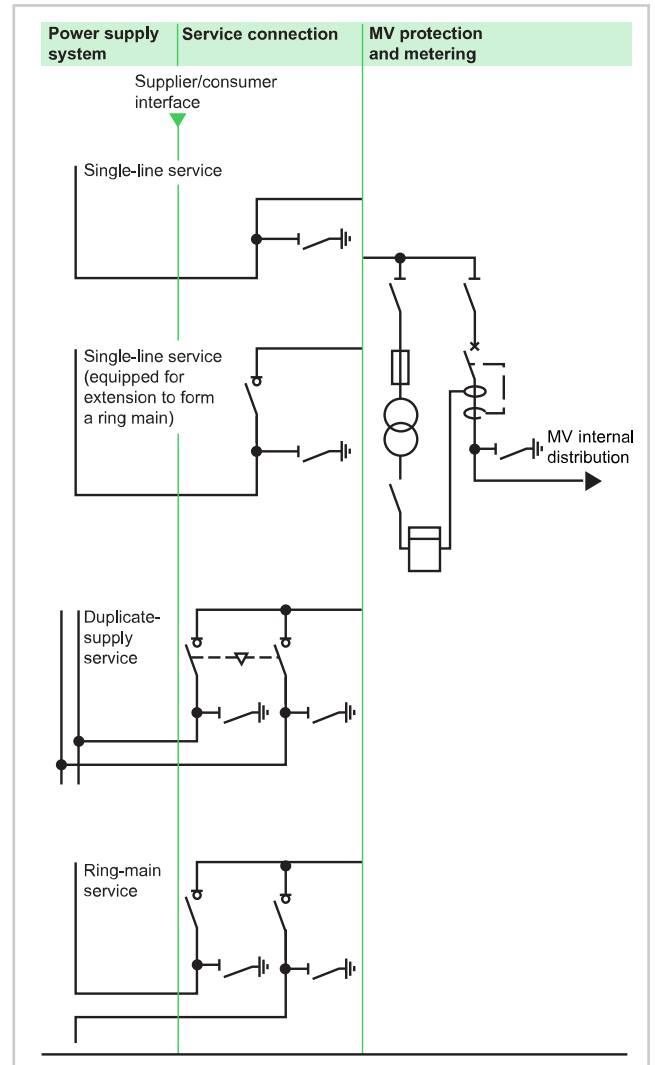

Figure 8 – MV connection with MV metering

### Internal MV circuits

Internal MV circuits are dedicated to supplying power to secondary MV/LV substations dispersed throughout the installation, **see Figures 9 and 10**, and there are three methods typically used to do so:

- Single feeder
- Dual feeder
- Open ring

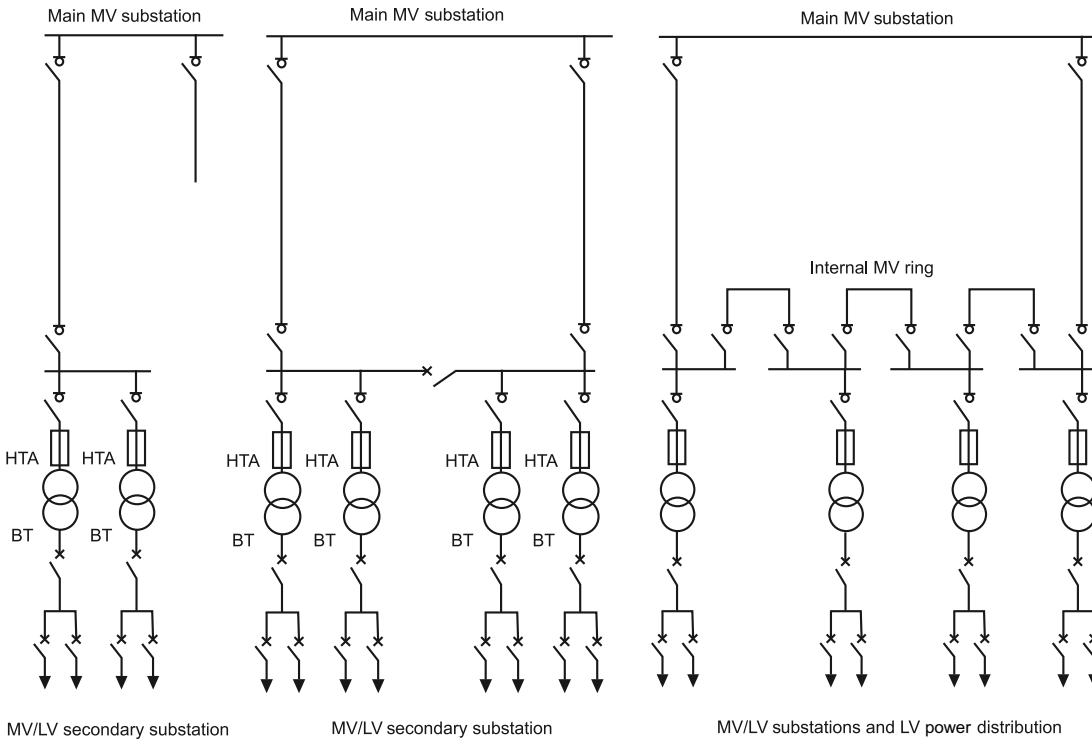

Figure 9 – Single feeder, dual feeder, open ring

	MV circuit configuration		
Characteristic to consider	Single feeder	Dual feeder	Open ring
Site topology	Any	Single or several buildings	Single or several buildings
Power demand	Any	> 2500kVA	> 1250kVA
Disturbance sensitivity	Long interruption acceptable	Short interruption not acceptable	Short interruption acceptable

Figure 10 – Comparison of the typical internal circuits

### Determining the number and location of MV/LV transformer substations

The main criteria to consider when determining the number and the location of the MV/LV substations are:

- Number of buildings
- Surface area of each building
- Number of floors per building
- Apportioning and distributing power to consumers
- Power demand per area, floor, building
- Sensitivity to interruption and need for redundancy

To establish the optimal number and the location of MV/LV substations, the following criteria should be considered:

- **Small or medium-size buildings** - a single MV/LV substation.
- **Large buildings** – one, or several MV/LV substations depending on the power requirements and the apportionment to consumers.
- **Buildings with multiple floors** – one or several MV/LV substations depending on the power requirements and the apportionment to consumers, or a single MV/LV substation dedicated to each floor.
- **Large sites with several buildings** - one MV/LV substation may be dedicated to each building.

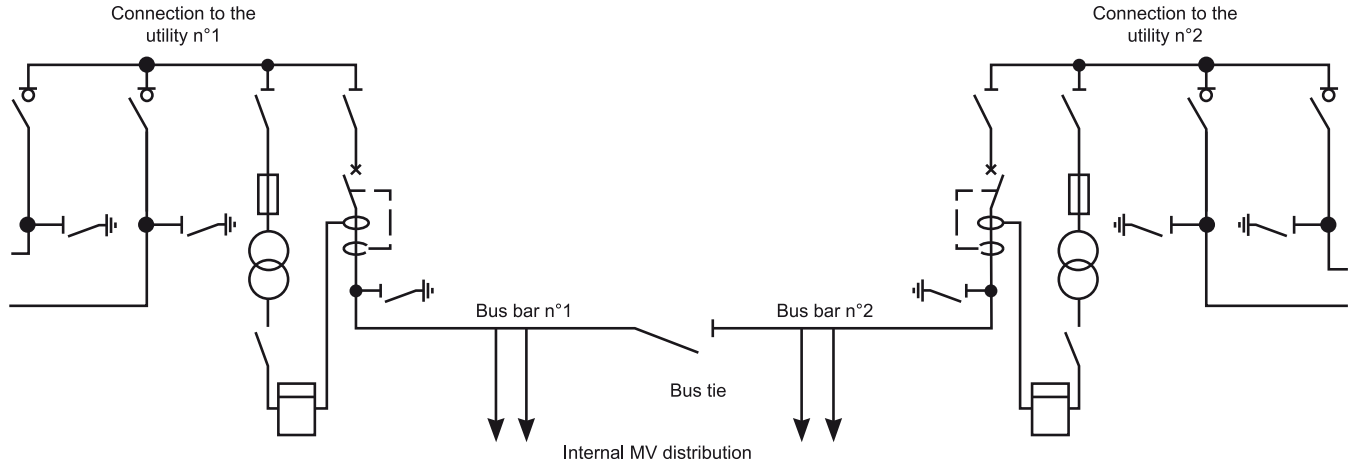

Figure 11 – Dual MV connection with MV metering

## Establishing the number of MV/LV transformers

For every MV/LV substation, identifying the number of MV/LV transformers should consider the following criteria:

- Total power supplied by the substation.
- Standardization of the rated power to reduce the number of spare transformers.
- Limit of the rated power - it is often recommended to establish the limit at 1250 kVA in order to facilitate transformer handling and replacement.
- Scalability of the installation.
- Necessity to split the loads with a high level of sensitivity to electrical disturbances.
- Need to dedicate a transformer to loads generating a high level of disturbances such as voltage dips, harmonics, or flicker.
- Any prerequisite for partial or total redundancy, such as requiring two transformers that are each sized for the full load and equipped with an automatic changeover.
- Loads that require a dedicated neutral system to ensure continued operation in case of phase-to-earth fault.

## LV or MV backup generator

If there is a MV connection to the utility network and if it is necessary to ensure the supply for the entire, or a large portion of the loads during a utility failure, then MV backup generators are required.

For other situations, LV backup generators are sufficient.

The main criteria to consider for implementing MV backup generators are the following:

- Site activity
- Sensitivity of the loads to power interruptions
- Level of availability from the public distribution network
- Alternate supplies and processes including a co-generation system
- Requirements to optimize energy billing



# Choice of design details

## Design optimization

Multiple factors contribute to designing a fully optimized distribution system

### LV distribution - choosing between a centralized or distributed layout

#### Layout

Determine the position of the main MV and LV equipment on the site or in the building. This layout choice is applied to the results of stage one.

- 1. Selection guide** – IEC 60364-8-1 §6.3, recommends MV/LV substation locations be determined by using the barycenter method, **see Figure 12:**
  - Factoring in service conditions – for dedicated premises, if the layout in the workshop is too restrictive due to factors such as temperature, vibrations, dust, etc.
  - Placing heavy equipment (transformers, generators, etc.) close to walls or to main exits for ease of access and maintenance.

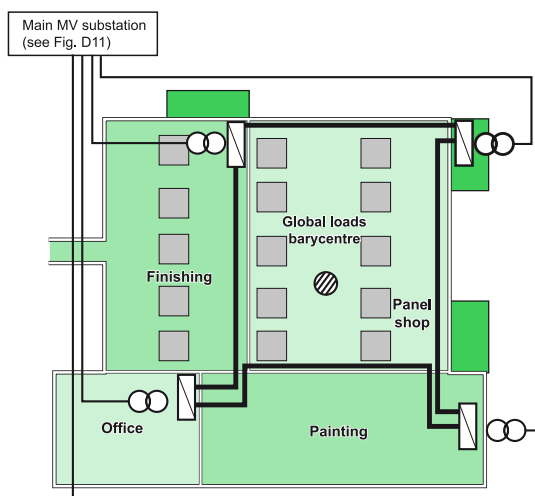

Figure 12 – Layout example. The position of the global load barycentre guides the positioning of power sources.

#### 2. Centralized or distributed layout for LV

**distribution** – In a centralized layout, each load is connected directly to the power source, **see Figure 13.**

In a distributed layout, **see Figure 14**, loads are connected to sources via a busway. This type of distribution method is well suited to supply many widely dispersed loads, when simple modification is required or, in the future, when new connections are needed.

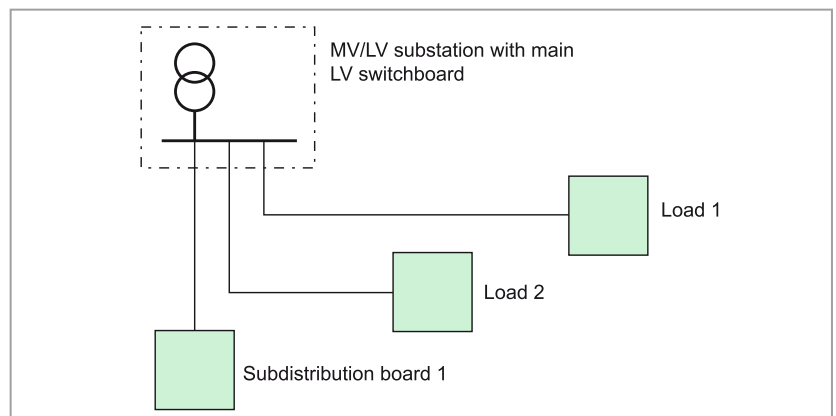

Figure 13 – Example of centralized layout with point to point links

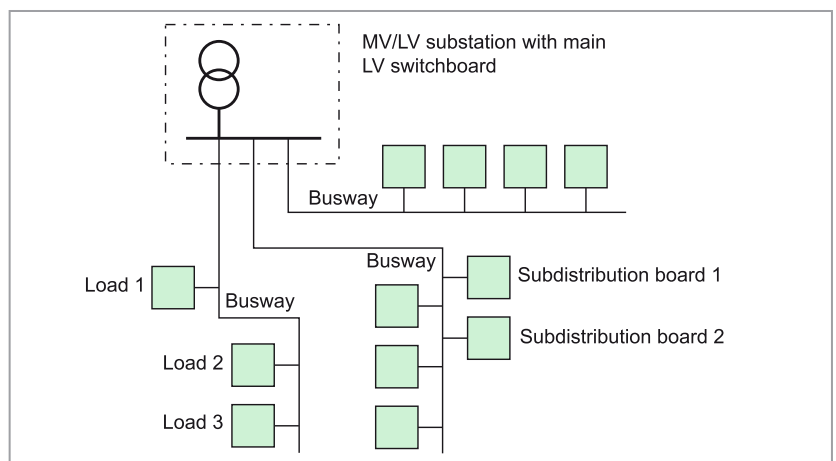

Figure 14 – Example of distributed layout, with busway

**Factors favoring a centralized layout include:**

- Installations expected to require few future modifications.
- Localized loads, such as high unit power loads.

**Factors in favor of distributed layout include:**

- Installations requiring flexibility, such as relocating of workstations.
- Load distribution - uniform distribution of low or medium unit power loads.

Centralized distribution offers greater isolation for circuits, reducing the consequences of a failure from a power availability perspective. Using decentralized distribution with a busway is a way to merge all the circuits into one, making it possible to take into account the diversity factor (ks), which can offer cost savings on conductor sizing. The choice between centralized and decentralized solutions, according to the diversity factor, balances the competing priorities of investment costs, installation costs, and operating costs.

	Load distribution		
	Localized loads	Intermediate distribution loads	Uniformly distributed loads
Flexibility (see Installation flexibility for definition of the flexibility levels)			
No flexibility	Centralized		Decentralized
Flexibility of design			
Implementation flexibility	Centralized	Decentralized	
Operation flexibility			

Figure 15 – Recommendations for centralized or distributed layout

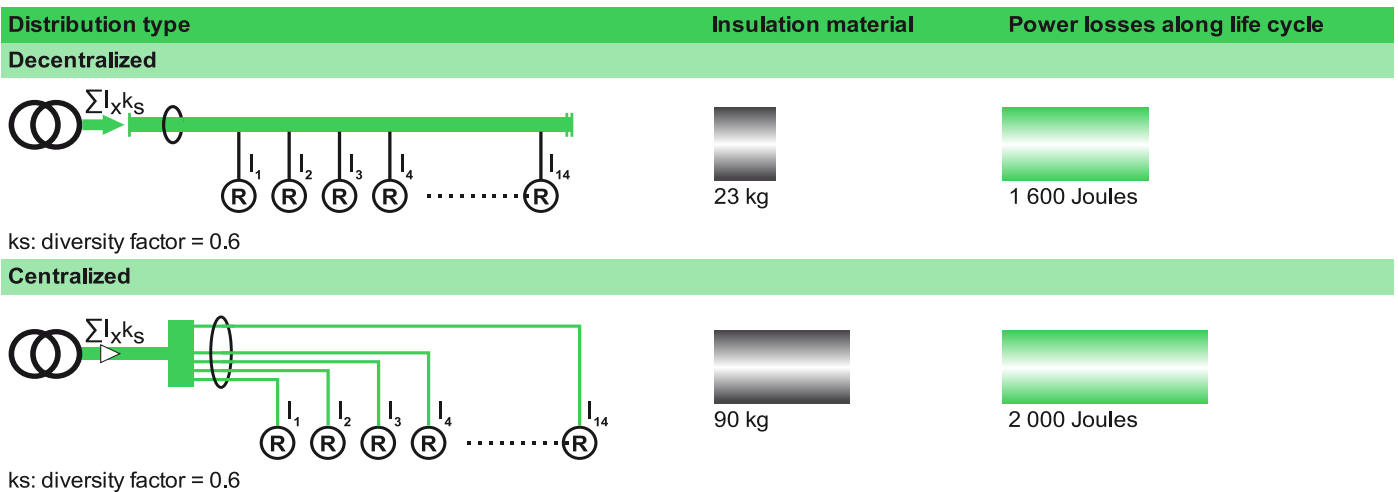

Figure 16 – Example of a set of 14 x 25A loads distributed along 34 meters (for busway, Canalis KS 250A)

## Configuration of LV circuits

LV circuits can be designed using several different configurations:

### Single feeder configuration

This is the simplest and most common circuit type. A load is connected to a single source, providing a minimum level of availability since there is no redundancy in the event of a power failure.

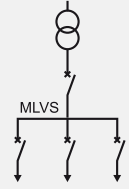

### Parallel transformers configuration

Power is provided by more than one transformer and is generally connected in parallel to the same main LV switchboard.

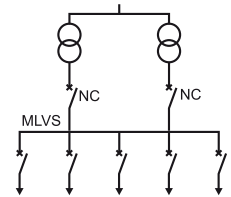

### Variant: Normally open coupled transformers

In order to increase power availability it is possible to split the main LV switchboard into two parts. This configuration may require an automatic transfer switch between the coupler and transformer incomers. Either configuration is more often used when power demand is greater than 1 MVA.

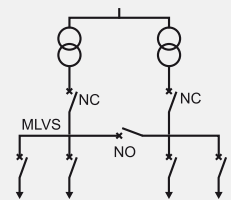

### A main LV switchboard interconnected with a busway

In this configuration, transformers are physically distant, and operate in parallel. They are connected by a busway, and the load can be supplied in the event of failure by one of the sources. This redundancy can be:

- Total - each transformer being able to supply the entire installation.
- Partial - each transformer is able to supply only part of the installation, meaning a portion of the load must be disconnected in the case one transformer fails.

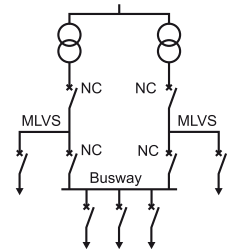

### LV ring configuration

This arrangement is an extension of the previous configuration with a connection between switchboards. Typically it is four transformers connected in parallel to the same MV line to supply a ring using busway. A given load is then supplied by several transformers. This configuration is well suited to large sites with high load density (in kVA/m<sup>2</sup>). If every load can be supplied by three transformers then there is total redundancy in case one transformer fails and in fact, each busbar can be fed at either end. Otherwise, a downgraded operation must be considered (with partial load shedding). This configuration requires a special attention to designing appropriate protection in order to ensure selectivity in any fault circumstances.

As with the previous configuration, this type of installation is commonly used in the automotive industry or by large manufacturing facilities.

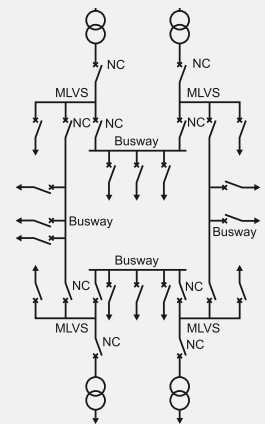

### Double-ended power supply

This configuration is frequently used when maximum availability is required. The principle involves having two independent power sources, for example:

- Two transformers, each supplied through different MV lines.
- One transformer and a single generator.
- One transformer and one UPS.

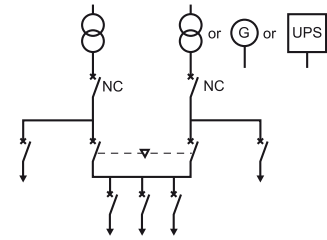

An automatic transfer switch (ATS) is used to avoid the sources being connected in parallel. An advantage of this configuration is that it allows preventive and curative maintenance to be carried out on the electrical distribution system upstream without interrupting the power supply.

### Configuration combinations

Installations can be made up of several sub-assemblies with unique configurations, as to availability requirements for different types of loads. For example, a generator unit and a UPS, or the implementation can vary by sector with some sectors supplied by cables and others by busways.

For the different possible configurations, the most probable and usual set of characteristics is given in the following table:

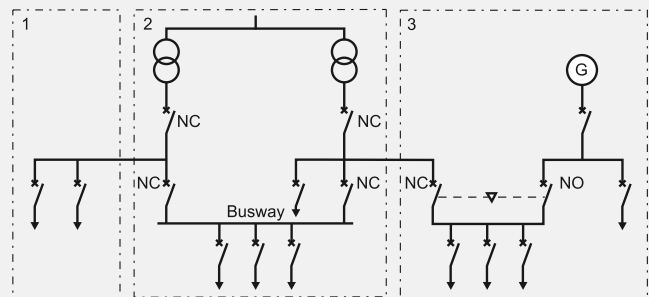

Example of a configuration combination 1: Single feeder, 2: Main LV switchboard interconnected by a busway, 3: Double-ended

Characteristic to be considered	Configuration				
	Single feeder (fig. D20)	Parallel transformer or transformers connected via a coupler (fig. D21-D22)	Main LV switchboard interconnected by a busway (fig. D24)	LV ring	Double-ended
Site topology	Any	Any	1 level 5000 to 25000 m2	1 level 5000 to 25000 m2	Any
Power demand	< 2500kVA	Any	≥ 2500kVA	> 2500kVA	Any
Location latitude	Any	Any	Medium or high	Medium or high	Any
Load distribution	Localized loads	Localized loads	Intermediate or uniform load distribution	Intermediate or uniform load distribution	Localized loads
Maintainability	Minimal	Standard	Standard	Standard	Enhanced
Sensitivity to disturbances	Low sensitivity	High sensitivity	High sensitivity	High sensitivity	High sensitivity

Figure 17 – Recommendations for the configuration of LV circuits



### Presence of LV backup generators

A LV backup generator is an alternator that is mechanically powered by a thermal engine. It cannot provide electrical power until the generator has reached its rated speed, making it unsuitable as an uninterruptable power supply. If the generator is sized to supply power to all, or only part of the installation, there needs to be either total or partial redundancy.

A backup generator generally runs disconnected from the network, requiring a source changeover and an interlocking system.

The generator backup time depends on the quantity of available fuel.

Principle characteristics to consider when implementing LV backup generator include:

- The sensitivity of loads to power interruptions.
- The reliability and availability of the utility power supply.
- Additional constraints such as regulations and design requirements.

An additional consideration is any requirement to reduce energy billing or exploit opportunities for co-generation.

The presence of a backup generator is essential if loads cannot be shed, such as when only short interruptions are considered acceptable, or if the utility network availability is low.

Determining the number of backup generator units aligns with the same criteria as determining the number of transformers, as well as taking into account cost and availability factors such as redundancy, start-up reliability, and maintenance requirements.

Determining the generator's power output depends on the:

- Power demanded by the loads to be supplied.
- Transient constraints that can arise from motors inrush current factors, for example.

### Requirement for an Uninterruptible Power Supply (UPS)

A UPS can supply power from storage units, such as batteries or an inertia wheel, to prevent any interruption in the flow of power. The backup power supplied by the system is generally limited from a few minutes to several hours.

Deploying a backup generator together with a UPS can be used to permanently supply loads for which no failure is acceptable. The backup time of the battery must be compatible with the maximum time the generator requires to start and fully take over the load supply.

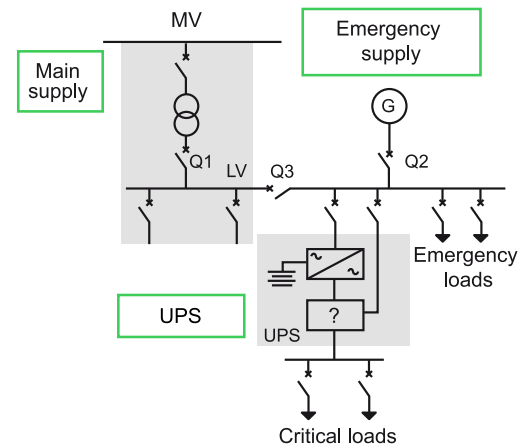

Figure 18 – Connection of a backup generator

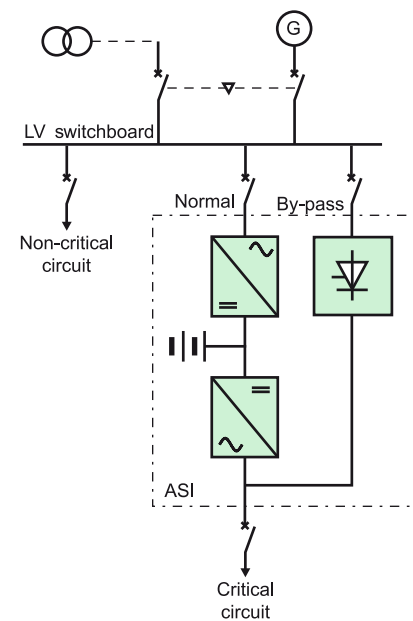

Figure 19 – Example of connection for a UPS

A UPS unit can also be used to supply loads that are sensitive to poor power quality voltage because its supply is independent of the network.

The leading characteristics to be considered for implementing a UPS include:

- The sensitivity of loads to power interruptions.
- The sensitivity of loads to disturbances.

The choice of UPS and the associated configurations is defined by the following criteria:

- **Availability:** A level of availability meeting the needs of the application.
- **Maintainability:** Ensure easy maintenance of the equipment under safe conditions for personnel and without interrupting operation.
- **Upgradeability:** It must be possible to upgrade the installation over time, considering both the need to expand the installation gradually and operating requirements.
- **Discrimination and non-propagation of faults:** It must be possible to limit faults to as small a part of the installation as possible, while enabling servicing without stopping operations.
- **Installation operation and management:** Make operations easier by providing the means to anticipate.

There are multiple UPS configurations, **see Figures 20 and 21:** single UPS, parallel UPS, modular UPS, with or without redundancy. You can find below the main highlights of configurations based on our Galaxy range. For more details, please consult our [Secure Power specifier's guide](#).

### Architecture optimization recommendations that can enhance electrical power availability

These recommendations are intended to guide designers towards architecture upgrades that improve assessment criteria.

#### On-site work

In order to optimize on-site work time for maintenance or installation, it is recommended to reduce variables and limit uncertainties by applying the following recommendations:

- Use proven solutions and equipment that has been validated and tested by manufacturers, such as functional switchboards or manufacturer switchboards, as dictated by application criticality.
- Prioritize the specification of equipment where there is a reliable distribution network and for which it is possible to have local, supplier-backed support.
- Select factory-built equipment in order to reduce the volume of operations on site.
- Limit the number of equipment suppliers to help ensure interoperability, particularly for sensitive equipment such as transformers.

#### Preventive maintenance levels

Recommendations for reducing the amount of preventive maintenance:

- Use the same recommendations as for reducing the work site time.
- Focus maintenance work on critical circuits.
- Standardize the choice of equipment.
- Use equipment designed for severe conditions, as it requires less maintenance.



[Download](#) the Secure power specifier's guide

### Electrical power availability

Recommendations for improving the electrical power availability:

- Reduce the number of feeders per switchboard to limit the effects of a possible switchboard failure.
- Distribute circuits according to availability requirements.
- Use equipment that is in line with identified requirements.
- Follow the selection guides proposed for steps 1 & 2.

Recommendations to increase the level of availability:

- Change from a radial single feeder configuration to a configuration using parallel transformers.
- Change from a parallel transformer configuration to a double-ended configuration.
- Add a UPS unit and a static transfer switch to a double-ended configuration.

Standard diagram number	Criteria for comparison				
	Availability	MTBF	Maintainability	Upgradeability	Comment
1. Single UPS	99.99790%	M1=475 000 h	*	4 parallel-connected UPS units	Reference for calculations
2. Two integrated parallel UPS units	99.99947%	up to 4 x M1	**	4 parallel-connected UPS units	
3. Integrated parallel units and external maintenance bypass	99.99947%	up to 4 x M1	**	4 parallel-connected UPS units	
4. Isolated redundancy	99.99970%	6.8 x M1	**		Flexible
5. Centralized SSC	99.99968%	6.5 x M1	**	6 parallel-connected UPS units	
6. Total isolation, single busbar	99.99968%	6.5 x M1	***	6 parallel-connected UPS units	
7 Total isolation, double busbar	99.99968%	6.5 x M1	***	6 parallel-connected UPS units	

Figure 20 – Single-source configurations

Standard diagram number	Criteria for comparison				
	Availability	MTBF	Maintainability	Upgradeability	Comment
8. Isolated redundancy N+1	99.99970%	7 x M1	**	No limit	
9. Redundant 2N	99.9999%	7 x M1	****	No limit to the power rating	No propagation of faults
10. Redundant 2N+1	99.9999%	7 x M1	****	No limit to the power rating	+ load management
11. Redundant 2N+2	99.99995%	The highest availability!	*****	No limit to the power rating	+ load management

\*\*\*\* excellent    \*\*\* good    \*\* fair    \* poor

Figure 21 – Multi-source configurations

# Choice of design details

## EcoStruxure™ reference designs: hospital, data center, and hotel

Schneider Electric has worked with more than 70,000 consulting companies and engineering firms who often require assistance relating to the prevention of downtime by design. Today, we make it easy and cost-effective to design, build, operate, and maintain resilient, high availability power management systems. We do so by offering EcoStruxure Reference Designs for hospitals, data centers, hotels, and other applications. Additionally, we help to ensure these systems are future-proof and optimized for maximum uptime, while also helping to keep CapEx and OpEx spending as low as possible.

Ready-to-use reference designs are compliant with the standards and specifications of each application are available. Examples include:

### Hospitals

The [Hospital digital electrical distribution reference design](#) is based on the IEC 60364-7-710 standard for medical location recommendation dealing with Groups 2, 1 and 0 as medical locations with 0,5s; 15s; over 15s energy availability requested performance, respectively.

The single-line diagram is composed of an N+1 diesel generator and UPS backup systems and a 2N path to help to maximize the energy availability performance and optimize CapEx.

Digitization reinforces the continuity of service with monitoring and remote-control systems, and contributes to the reduction of electrical shock with IT network power supply for operating wards, and help to reduce fire risks thanks to thermal monitoring in MV/LV switchgear or arc fault detection devices in distribution boards. Digitization also improves operational efficiency through condition-based maintenance reporting.

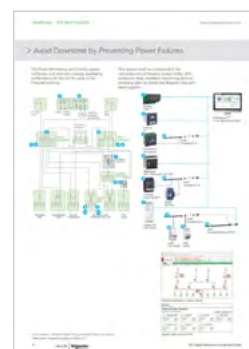

## Data Centers

[Reference Design for Data Center](#) power supply, cooling system and IT space.

A data center is a facility hosting IT devices. It is characterized by its IT power, availability level, and building space. Schneider Electric's reference designs help address typical planning challenges to better design data centers with high availability, safety, and operational efficiency.

Three areas are critical to designing a high-performing and efficient data center. Each one is covered with technical recommendations and possible variations:

1. **Facility Power:** Addresses the electrical architecture for the power supply of all critical and non-critical components
2. **Facility Cooling:** Addresses the cooling system in IT space
3. **IT Space:** Address the selection and arrangement of key components and equipment: racks, PDUs, and security management system.



## Hotels

[Summary of Reference Design for IEC Large & Luxury Hotel > 700 rooms](#)

Large and luxury hotels are complex facilities utilizing many systems to manage different processes. Guests come and leave at all hours of the day or night. Thus, the operating hours of a hotel are around the clock, 365 days per year.

The electrical distribution system will be summarized in the available document.

Avoiding downtime is a top priority in hospitality operations. Hotels need to master energy use and protect loads against disturbances. Full visibility into the electrical distribution (including metering, visualization, and control) contributes to a performing and reliable electrical system. This ranges from MV and LV systems, to final distribution.

Schneider Electric EcoStruxure is designed to master all of these points, regardless of the hotel size.

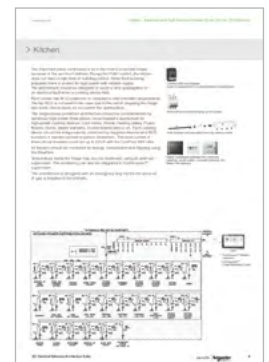
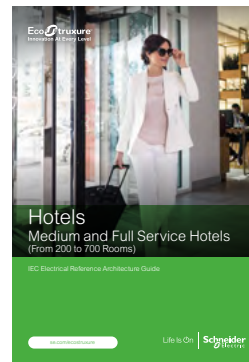

# Choice of design details

## Digital designs

For facility operations and maintenance teams, the benefits of a digitally- connected power distribution system are maximized when the end user use cases are considered. To help better understand the common use cases for power availability and how Schneider Electric integrates and validates systems, read the [EcoStruxure Power Digital Applications Design Guide](#).



VALUE PROPOSITION	END USER BENEFITS	RELATED APPLICATIONS			
POWER AVAILABILITY	Enhance electrical asset management	Electrical Asset Life Cycle Management	Asset Performance		
	Avoid unplanned downtime due to electrical failure	Electrical Distribution Monitoring and Alarming	Capacity Management	Backup Power Testing	Power Events Analysis
		Breaker Settings Monitoring	Power Quality Monitoring	Power Quality Correction	Power Control and Automation
Gain resilience with distributed energy resources	Microgrid				

The example below illustrates the application for electrical distribution monitoring and alarming, which provides an overview of the considerations needed from a use case perspective with specific outputs for the end user as well as considerations for design. These digital applications for power availability also enable remote services based on analytics and expert recommendations from a Schneider Electric Service Engineer or a qualified partner.

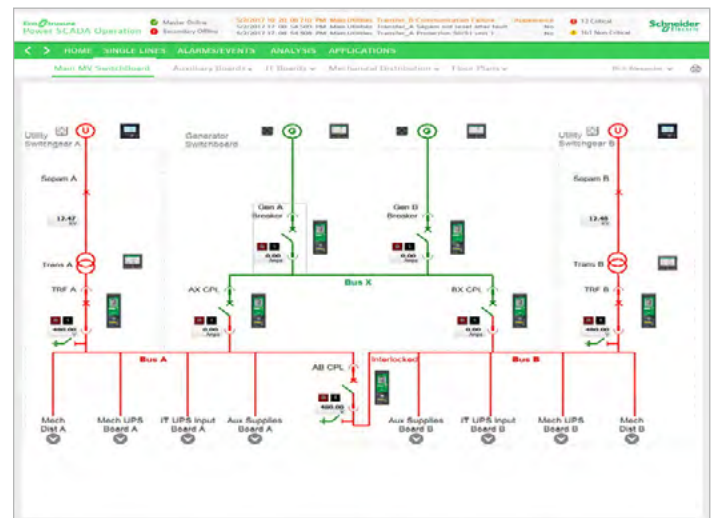
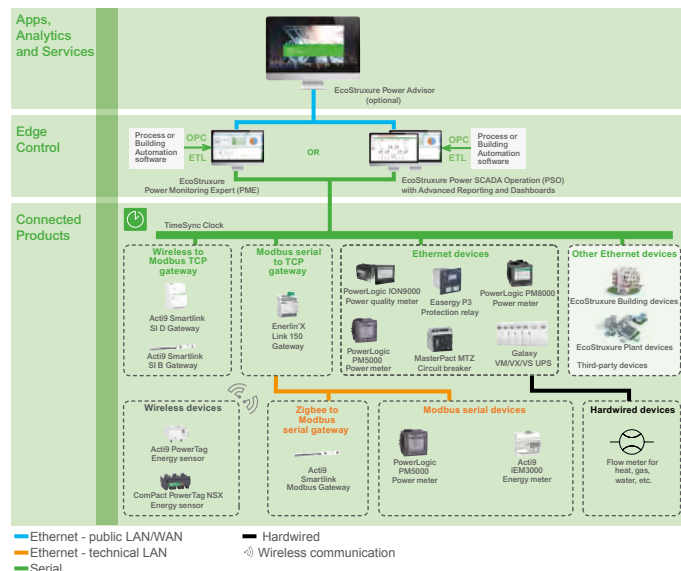

# Overview of EcoStruxure™ Power

## EcoStruxure Power

- **EcoStruxure Power digitizes and simplifies low and medium voltage electrical distribution systems.** It provides essential data to aid in making decisions that help protect people, safeguard assets, maximize operational efficiency and business continuity, while maintaining regulatory compliance.
- **EcoStruxure Power is an open architecture and platform** designed to make it easy to add, upgrade, and swap components. With the world full of electrical distribution systems in various stages of maturity and produced by a variety of manufacturers, interoperability with EcoStruxure Power is essential to making these power distributions systems future-ready. The added benefit of a holistic Schneider Electric system is plug-and-play connectivity to achieve faster, lower risk integration, and commissioning.
- **EcoStruxure Power architectures are cost-optimized** to deploy, using the right technology to deliver the desired business outcomes for users – no more, no less, even as customer needs and requirements change over time.
- **EcoStruxure Power is an exceptionally flexible system** that can scale from light commercial and industrial buildings, through critical facilities such as hospitals, data centers or infrastructures such as airports, rail, and oil and gas. Such scalability enables it to grow and evolve with changing needs or demands thanks to its modular architecture.
- **EcoStruxure Power architectures are fully adaptable power distribution systems** that offer the ability to adapt to dynamic and ever-changing conditions, such as balancing supply and demand by the hour or minute, or adding and then scaling on-site renewable generation capabilities over time. Connecting IT and OT systems into a single, easy-to-manage Ethernet IP network is at the heart of our digitization story. With EcoStruxure Power, facility managers can use the data they collect to make real-time decisions to maximize business continuity and optimize operations.



More about EcoStruxurePower  
[se.com/ecostruxure-power](https://www.se.com/ecostruxure-power)

# Our Vision of a New Electric World

The world is becoming more electric and digital, and power is becoming more distributed, more complex to manage, and more integrated into our everyday lives. We envision a New Electric World where building staff and occupants are safer, with zero electrical safety incidents. Where power is 100% available, with zero unplanned downtime. Where energy and operations are more efficient, with zero energy waste. And where operational systems are resilient, with zero cyber intrusions.

We strive to make this vision a reality with our IoT-enabled EcoStruxure architecture and platform, which we deliver through our connected energy management ecosystem – a collective of partners and industry experts who are openly collaborating with us to push innovation, enhance productivity, reduce risk, and unlock new growth opportunities.







## 02 How selectivity enhances uptime

In an installation with proper selectivity, only the circuit breaker protecting the overloaded/faulted part of the electrical network will trip, limiting a service interruption to the circuit experiencing the problem, rather than the entire system.

# Coordination between circuit breakers

## Selectivity

Design and selection of equipment for LV electrical installations are required to consider and check the behavior of all devices on the current path in a fault situation. High short-circuit current can damage equipment by electro-dynamical and thermal effects. Each device can individually withstand the worst effects, but it may require significant oversizing and, on occasion, may be impossible. So the protection of each device or equipment relies on an upstream overcurrent protective device. In that case, the proper “coordination” between the two devices can be checked.

Lower amplitude faults, such as overloads or some earth faults, can also create disturbances by causing trips and power interruptions for larger sections of the installation than expected.

European Harmonization document HD60364-5-53 2015 for LV electrical installations provide the following definition for coordination of electrical equipment:

530.3.5 co-ordination of electrical equipment: correct way of selecting electrical devices in series to help ensure safety and continuity of service of the installation taking into account short-circuit protection and/or overload protection and/or selectivity.

Schneider Electric provides “co-ordination” performances for two or three LV devices in the following cases:

### Coordination related to continuity of supply and/or proper functioning:

- Selectivity (also called discrimination)
- Selectivity enhanced by cascading
- Motor starter coordination type 2
- Circuit breaker and LV/LV transformers

### Coordination related to safety

- Cascading (also called group short-circuit protection, or back up protection)
- Motor starter coordination type 1
- Coordination between switch-disconnector and circuit breaker or fuses
- Coordination between circuit breaker and bus-bar trunking (busway) system



This guide provides information to verify your LV electrical distribution design’s robustness, by combining each of the benefits of selectivity and cascading for your design. [Download the Guide.](#)



For coordination of surge protection devices with upstream overcurrent protection [see our design guide.](#)

# Coordination between circuit breakers

## Selectivity (discrimination)

### Principles of Selectivity

Selectivity is achieved by overcurrent and earth fault protective devices if a fault condition, occurring at any point in the installation, is cleared by the protective device located immediately upstream of the fault, while all other protective devices remain unaffected.

Selectivity is required for installation supplying critical loads where one fault on one circuit does not cause the interruption of the supply of other circuits. In the IEC 60364 series it is mandatory for installations supplying safety services (IEC 60364-5-56 2009 560.7.4). Selectivity may also be required by local regulations or for some special applications like:

- Healthcare facilities
- Marine
- High-rise building

Selectivity is highly recommended when power availability and reliability is critical due to the nature of the loads such as:

- Data centers
- Infrastructures (tunnel, airport, etc.)
- Critical processes

From an installation point of view: selectivity is achieved when the maximum short-circuit current at a point of installation is below the selectivity limit of the circuit breakers supplying this point of installation. Selectivity shall be checked for all circuits supplied by one source and for all types of fault:

- Overload
- Short-circuit
- Earth fault

When a system can be supplied by different sources (grid or generator set, for instance) selectivity shall be checked in both cases.

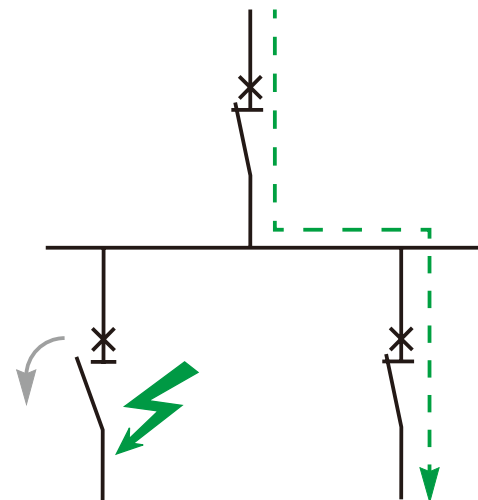

Selectivity is essential to help ensure continuity of supply and faster fault localization.

According to the IEC 60364-5-53:535 2019 standard, the selectivity between two circuit breakers can be:

- **Partial:** up to a specified value according to circuit breakers characteristics ( $I_s$ )
- **Full:** up to the maximum prospective short-circuit ( $I_{sc\_max}$ ) current on the load side of the downstream circuit breaker
- **Total:** up to the breaking capacity ( $I_{cu}$  or  $I_{cn}$ ) of the downstream circuit breaker
- **Enhanced:** up to a value higher than the breaking capacity of the downstream circuit breaker when cascading is applied

In an electrical installation, selectivity performance depends on the two circuit breakers characteristics and the installation's maximum short-circuit current on the load side.

**The table below summarizes these different situations:**

	Selectivity characteristics of two circuit breakers	Short-circuit current on the load side versus the selectivity limit $I_s$ of the two circuit breakers	Selectivity consequence for the electrical installation	
Without cascading	Partial	$I_s \leq I_{sc\_max} < I_{cu}$ (or $I_{cn}$ )	"Partial" (Example 1a)	☹️
		$I_{sc\_max} < I_s < I_{cu}$ (or $I_{cn}$ )	"Full" (Example 1b)	😊
With cascading	Total	$I_{sc\_max} \leq I_s = I_{cu}$ (or $I_{cn}$ )	"Total" (Example 2)	😊
	Partial	$I_s < I_{cu} < I_{sc\_max}$	Partial (up to $I_s$ )	☹️
	Total	$I_s = I_{cu} < I_{sc\_max}$	Partial (up to $I_{cu}$ but $< I_{sc\_max}$ )	☹️
	Enhanced	$I_{cu} < I_{sc\_max} \leq I_{s\_enhanced}$	Enhanced selectivity (up to $I_{s\_enhanced}$ ) (Example 3)	😊

Selectivity in a given installation according to circuit breakers selectivity performance without or with cascading (or backup or combined short-circuit protection)

$I_{cu}$  : breaking capacity of circuit breaker according to IEC/EN 60947 series

$I_{cn}$  : breaking capacity of circuit breaker according to IEC/EN 60898 or IEC/EN 61009 series

From a designer's perspective, a simple way of specifying selectivity in an electrical installation can be either:

- "Total selectivity between circuit breakers is required and cascading is forbidden"

or

- "Total selectivity between circuit breakers is required. If cascading is applied, enhanced selectivity up to the maximum short-circuit current shall be ensured"

Different solutions are provided to achieve selectivity based on:

- Current
- Time
- Energy
- Logic

### Current based selectivity:

This method is realized by setting successive tripping thresholds at stepped levels, from downstream circuits (lower settings) towards the source (higher settings). Selectivity is total or partial, depending on particular conditions, as noted above.

### Time based selectivity

This method is implemented by adjusting the time-delayed tripping units, such that downstream relays have the shortest operating times, with progressively longer delays towards the source. In the two-level arrangement shown, upstream circuit breaker A is delayed sufficiently to help ensure total selectivity with B (for example: MasterPact with electronic trip unit).

Selectivity category B circuit breakers are designed for time based selectivity.

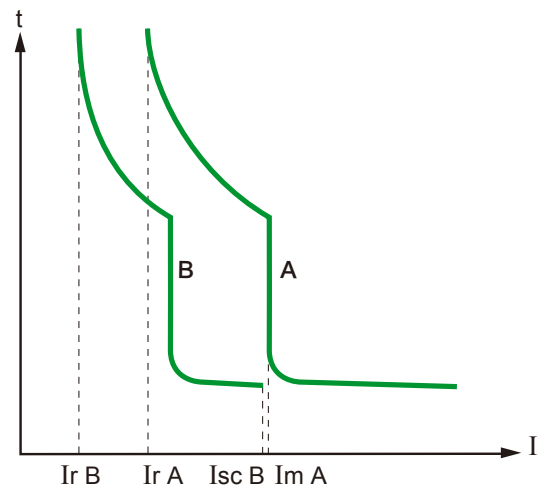

Total selectivity between CBs A and B.

### Selectivity based on a combination of the two previous methods

A time-delay added to a current level scheme can improve overall selectivity performance.

The upstream CB has two magnetic tripping thresholds:

- bblm A: delayed magnetic trip or short-delay electronic trip
- bbli: instantaneous trip

Selectivity is total if  $I_{sc B} < I_i$  (instantaneous)

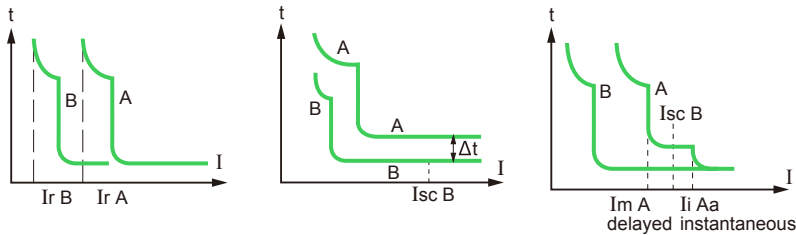

Current based selectivity, time based selectivity, combination of both

### Protection against high-level short-circuit currents: Selectivity based on arc-energy levels

Where time versus current curves are superposed, selectivity is possible with limiter circuit breakers when they are properly coordinated.

**Principle:** When a very high-level short-circuit current is detected by the two circuit breakers A and B, their contacts open simultaneously. As a result, the current is highly limited.

- The very high arc-energy at level B induces the tripping of circuit breaker B
- Then, the arc-energy is limited at level A and is not sufficient to induce the tripping of A

This approach requires accurate coordination of limitation levels and tripping energy levels. It is implemented inside the ComPacT NSX range (current limiting circuit breaker) and between ComPacT NSX and Acti9 range. This solution is the only one to achieve selectivity up to high short-circuit current with selectivity category A circuit breaker according to IEC 60947-2.

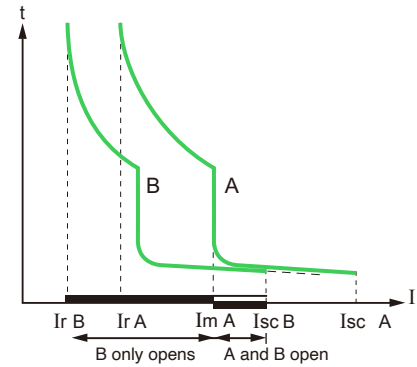

Partial selectivity between CBs A and B

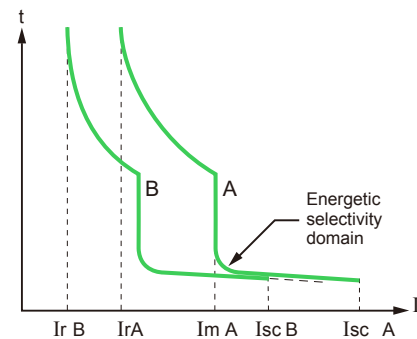

Energetic-based selectivity.

# Coordination between circuit breakers

Practical example of selectivity at several levels

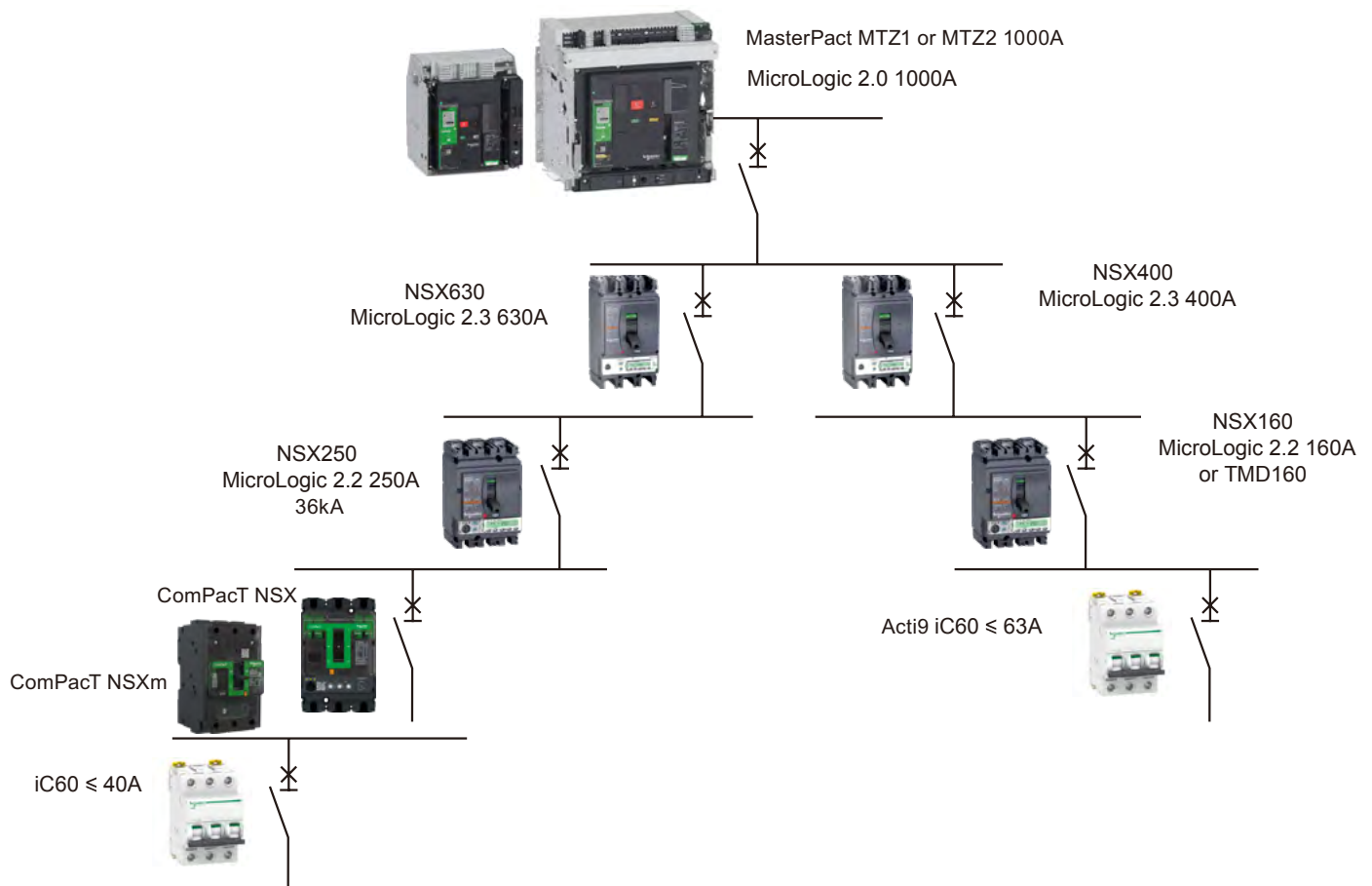

Schneider Electric circuit breakers (with electronic trip units)



### Selectivity enhanced by cascading

Cascading between two devices is normally achieved by using the tripping of the upstream circuit breaker A to help the downstream circuit breaker B to break the current.

By principle, cascading is in contradiction with selectivity. But the energy selectivity technology implemented in ComPacT NSX circuit breakers allows to improve the breaking capacity of downstream circuit breakers and at the same time keep a high selectivity performance.

The principle is as follows:

- The downstream limiting circuit breaker B sees a very high short-circuit current. The tripping is very fast (<1 ms) and then, the current is limited.
- The upstream circuit breaker A sees a limited short-circuit current compared to its breaking capability, but this current induces a repulsion of the contacts. As a result, the arcing voltage increases the current limitation. However, the arc energy is not high enough to induce the tripping of the circuit breaker. Thus, the circuit breaker A helps the circuit breaker B to trip, without tripping itself. The selectivity limit can be higher than Icu B and the selectivity becomes total with a reduced cost of the devices.

### Logic selectivity or “Zone Sequence Interlocking” (ZSI)

This type of selectivity can be achieved with circuit breakers equipped with specially designed electronic trip units (ComPacT, MasterPact): only the Short Time Protection (I<sub>sd</sub>, T<sub>sd</sub>) and Ground Fault Protection (GFP) functions of the controlled devices are managed by logic selectivity. In particular, the Instantaneous Protection function is not concerned.

One benefit of this solution is to have a short tripping time with a selectivity category B circuit breaker. Time-based selectivity on a multi-level system implies a long tripping time at the origin of the installation.

**Note:** This technique can help ensure selectivity even with circuit breakers of similar ratings.

Selectivity schemes based on logic techniques are possible, using circuit breakers equipped with electronic tripping units designed for the purpose (ComPacT, MasterPact) and are interconnected with pilot wires.

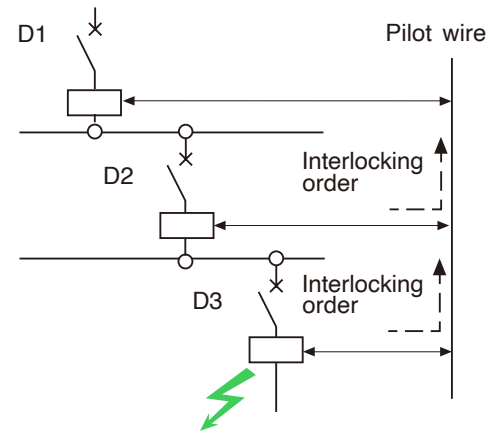

Logic selectivity

## Operation

A pilot wire connects in cascading form the protection devices of an installation. When a fault occurs, each circuit breaker upstream of the fault (detecting a fault) sends an order (high-level output) and moves the upstream circuit breaker to its set time delay (high-level input). The circuit breaker placed just above the fault does not receive any orders (low-level input) and thus trips almost instantaneously.

## Selectivity between ComPacT NSX upstream and modular circuit breakers downstream

ComPacT NSX circuit breakers have been designed to help ensure total selectivity with Acti9 range.

- Total selectivity between ComPacT NSX 100 A with electronic trip unit and Acti9 circuit breaker up to 40 A.
- Total selectivity between ComPacT NSX u 160 A with TMD trip unit u125 A or electronic trip unit and Acti9 up to 63 A.



## Selectivity between ComPacT NSX circuit breakers

Thanks to the Roto-Active breaking principle in the ComPacT NSX, a combination of Schneider Electric circuit breakers provide an exceptional level of selectivity between protection devices.

This performance is due to the combination and optimization of 3 principles:

1. current selectivity,
2. energy selectivity,
3. time selectivity.

### Protection against overloads: current selectivity

The protection is selective if the ratio between the setting thresholds is higher than 1.6 (in the case of two distribution circuit breakers).

### Protection against weak short circuits: time selectivity

Tripping of the upstream device has a slight time delay; tripping of the downstream device is faster.

The protection is selective if the ratio between the short-circuit protection thresholds is no less than 1.5.

### Protection against high short circuits: energy selectivity

This principle combines the exceptional limiting power of the ComPacT NSX devices and reflex release, sensitive to the energy dissipated by the short circuit in the device.

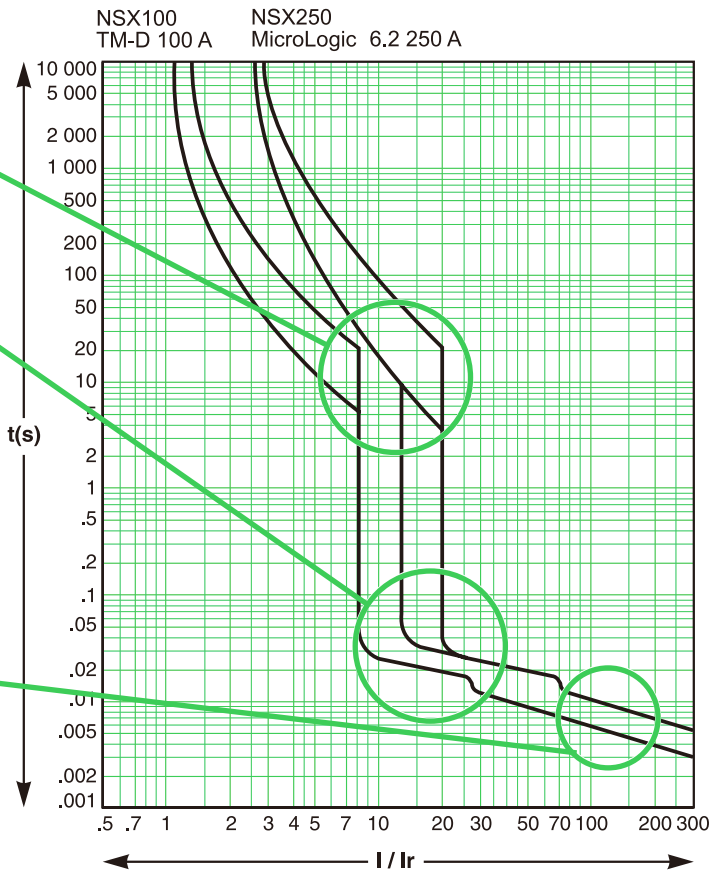

When a short circuit is high, if it is seen by two devices, the downstream device limits it greatly. The energy dissipated in the upstream device is insufficient to cause it to trip: there is selectivity for whatever the value of the short circuit.

The range has been designed to ensure energy selectivity between NSX630/NSX250/NSX100 or NSX400/NSX160.

### Selectivity between MasterPact or ComPacT NS $\geq$ 630 A upstream and ComPacT NSX downstream

Thanks to their high-performance control units and a very innovative design, MasterPact and ComPacT NS  $\geq$  630 A devices offer, as standard, a very high level of selectivity with downstream ComPacT NSX up to 630 A. Respect the basic rules of selectivity for overload and short-circuit, or check that curves do not overlap with Ecodial software.

Check the selectivity limit in tables for high short-circuit current or when using limiter circuit breakers (MasterPact MTZ1 L1 or ComPacT NS L or LB) upstream.

### Selectivity between MasterPact or ComPacT NS $\geq$ 630 A upstream and downstream

The utilization category of these devices (excepted limiters ones) is B according to IEC 60947 standard. Selectivity can occur with a combination of current selectivity and time selectivity.

Respect the basic rules of selectivity for overload and short-circuit, or check that curves do not overlap with Ecodial software.

Check the selectivity limit in tables for high short-circuit current or when using limiter circuit breakers (MasterPact MTZ1 L1 or ComPacT NS L or LB).



### Selectivity of residual current devices

When circuit breakers are equipped with a residual current device (RCD) function, selectivity tables are valid for short-circuit and earth fault with high amplitude current.

RCDs are, by design, very sensitive to faults and should be coordinated properly to achieve total selectivity in addition to overcurrent protection.

Schneider Electric proposes a wide range of solutions to help ensure RCD function:

- Circuit breaker Add-On Residual Current Device (Vigi module)
- Circuit breaker with integrated RCD function
  - Residual Current circuit breaker (RCBO) like iCV40,
  - Earth Leakage circuit breaker (ELCB) like ComPacT NSXm with MicroLogic 4.1, ComPacT NSX MicroLogic 4.x or 7.x, MasterPact and ComPacT with MicroLogic 7.0,\*
- Circuit breaker with separate earth leakage relay (any circuit breaker with separated RH range)
- Residual current circuit breaker (no overcurrent) like Acti9 iLD range.

All these devices follow by design the same rules for sensitivity and tripping time even if they are covered by different standards (IEC/EN 61009-1, IEC/EN 60947-2 Annex B or Annex M, IEC 61008). So whichever type of RCD, the following rules apply:

- the sensitivity of the upstream RCD must be at least equal to three times the sensitivity of the downstream RCD
- the upstream RCD must be:
  - of the selective (S) type (or setting) if the downstream RCD is an instantaneous type,
  - of the delayed (R) type (or setting) if the downstream RCD is a selective type. The minimum non-tripping time of the upstream device will therefore be greater than the maximum tripping time of the downstream device for all current values.

$$I\Delta n D1 \geq 3 \times I\Delta n D2 \text{ \& } \Delta t (D1) > \Delta t (D2)$$



Example of MCCB available with integrated earth leakage protection



Example of a separate earth leakage relay RHU.

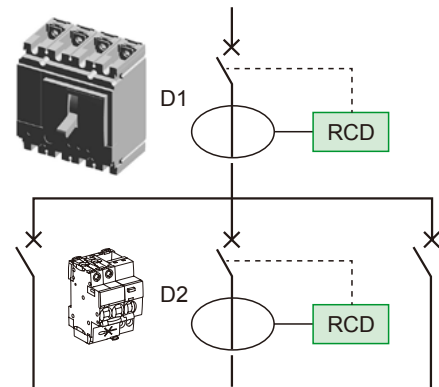

VigiPact and MicroLogic earth leakage protection accuracy is better than the minimum required by the standard, allowing a smaller ratio between the threshold. Selectivity between Schneider Electric RCDs is ensured if the settings respect the following rules:

Upstream	Downstream	Ratio $I\Delta n_{up} / I\Delta n_{down}$	Time delay
ComPacT NS, NSX, NSXm & MasterPact MicroLogic 4.*, 7.*	ComPacT NS, NSX, NSXm & MasterPact MicroLogic 4.*, 7.*	2	$\Delta t_{upstream}$ > Max. break time downstream
	VigiPact RH*	2	
	Other RCDs from Schneider Electric (Vigi Add on, RCCB and RCBO)	3	
VigiPact RH*	MicroLogic 4.*, 7.* (ComPacT & MasterPact)	1,5	
	VigiPact RH*	1,25	
	Other RCDs from Schneider Electric (Vigi Add on, RCCB and RCBO)	1,5	
Other RCD from Schneider Electric (Vigi Add on, RCCB and RCBO)	VigiPact RH*	2	
	Other RCDs from Schneider Electric (Vigi Add on, RCCB and RCBO)	3	

# Motor protection coordination

## Protection of motor circuit with circuit breaker

### Applicable standards

A circuit breaker supplying a motor must comply with the general rules set out in IEC 60947-4-1 and in particular with those concerning contactors, motor starters, and their protection as stipulated in IEC 60947-4-1, notably:

- coordination of the components of the motor circuit
- trip class for thermal relays
- contactor utilization categories
- coordination of insulation

### Coordination of the components of the motor circuit

#### Two types of coordination

The standard defines tests at different current levels. The purpose of these tests is to place the switchgear and controlgear in extreme conditions. Depending on the state of the components following the tests, the standard defines two types of coordination:

- **type 1:**  
Deterioration of the contactor and the relay is acceptable under two conditions:
  - no danger to operating personnel
  - no danger to any components other than the contactor and the relay
- **type 2:**  
Only minor welding of the contactor or starter contacts is permissible and the contacts must be easily separated.
  - following type-2 coordination tests, the switchgear and controlgear functions must be fully operational.

#### Which type of coordination is needed?

Selection of a type of coordination depends on the operating conditions encountered.

The goal is to achieve the best balance between the user's needs and the cost of the installation.

- **type 1:**
  - qualified maintenance service
  - low cost of switchgear and controlgear
  - continuity of service is not imperative or may be ensured by simply replacing the faulty motor drawer
- **type 2:**
  - continuity of service is imperative
  - limited maintenance service
  - specifications stipulating type 2

# Different types of coordination

## Coordination between on-load switches, transfer switches, and upstream protection

Switches are often located as the incomer of a switchboard or panel, and therefore their protection is crucial to support continuity of service for the installation. All switches must be protected by an overcurrent protection device placed upstream, to help ensure the switch is not seriously damaged in case of overload or short-circuit current.

Schneider Electric provides clear tables, showing the coordination performance of circuit breakers and switch disconnectors for major Schneider Electric ranges. In the event of an overload or a short-circuit, the circuit breaker proposed in **Figure 22** will help ensure the protection of the switch-disconnector according to its electrodynamic withstand, and short-time and permanent withstand.

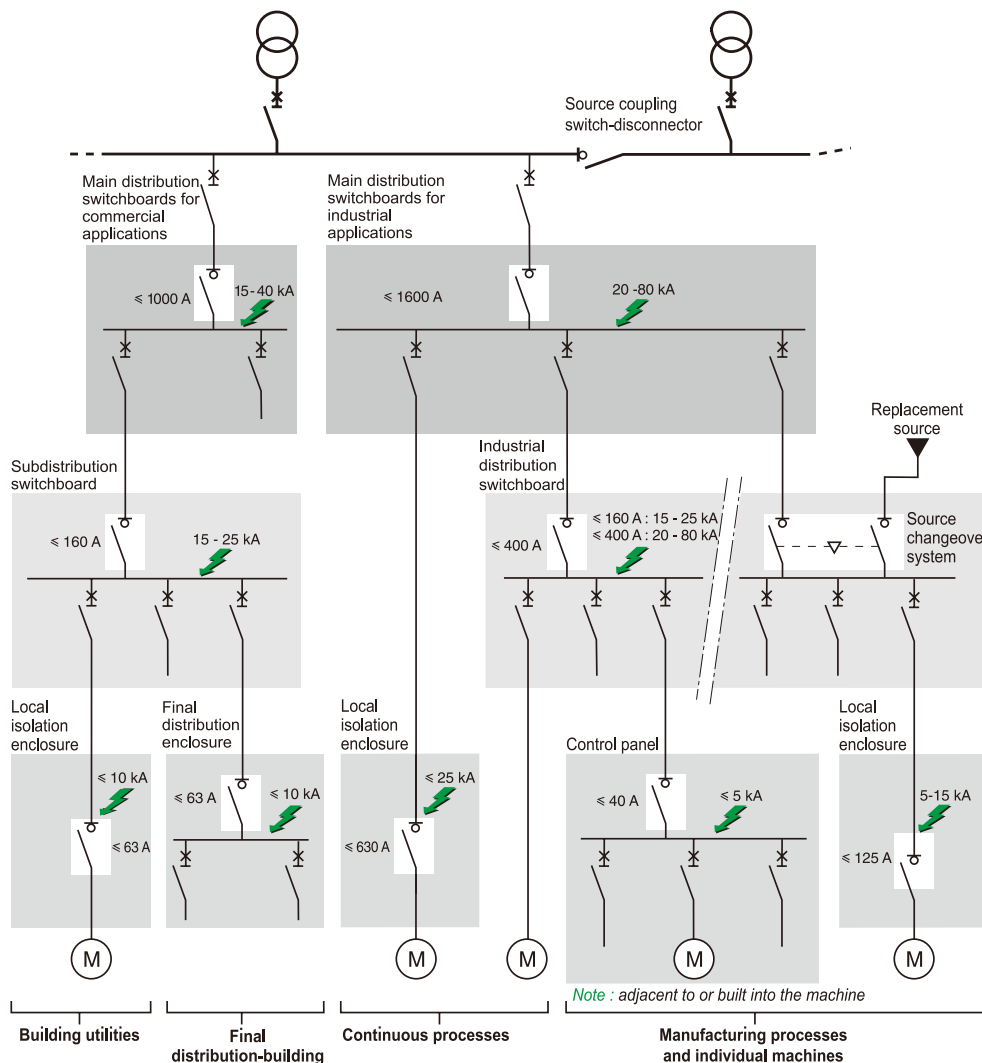

Figure 22 – Functions performed by switch



# Design software

Use the latest software and guides to optimize your installation design, and to calculate and size up your electrical components. These convenient tools help you select combinations of circuit breakers that provide total selective coordination (also referred to as selectivity down to 0.01 seconds), or optimized selectivity with cascading. Help decrease risk and uncertainty with up to 5 levels of selectivity available from cutting-edge products such as MasterPact MTZ, ComPacT NSX, etc.

## EcoStruxure Power Design Calculation Tool

An electrical calculation assistant offering a set of 7 computer-aided online tools designed to help you:

- Display the time-current curves of 1 to 8 circuit breakers
- Check the discrimination between two circuit breakers and display their time-current curves
- Search all the circuit breakers that can be selective with a defined circuit breaker
- Search all the circuit breakers that offer cascading with a defined circuit breaker
- Display the curves of two RCDs and check their discrimination
- Calculate the cross section area of cables and build a cable schedule
- Calculate the voltage drop of a defined cable and check its maximum length

All tools provide a report generation feature and no download is required thanks to direct access through your web browser.



[Use Calculation Tools](#)

## EcoStruxure Power Design – Ecodial

Ecodial is a user-friendly software that helps optimize your equipment and costs, while managing operating constraints during the electrical installation design phase of your project. The software helps make the design easier through a simple single-line diagram drawing, and defining properties such as load power, polarity, earthing system arrangement, cable length, and operating conditions, for example.

Check the consistency of selections between calculated switchgear and recommended equipment, while verifying electrical network uniformity for improved personnel safety. Designers can boost power availability by determining an optimal selectivity plan that helps ensure maximum uptime and a superior cascading plan to further optimize uptime and costs. Define backup generator modes in case of power shutdown, or secure critical loads through a UPS in the event of an unexpected power failure.



[Download EcoStruxure Power Design - Ecodial](#)

## Caneco ONE

All-in-one, standards-compliant, collaborative software suite that allows users to design, operate and test electrical installations. It enables tasks for:

- Calculation (including HV) and sizing
- Circuit diagrams
- BIM modeling
- Costing of LV/HV equipment
- Total cascading selectivity analysis by TCC

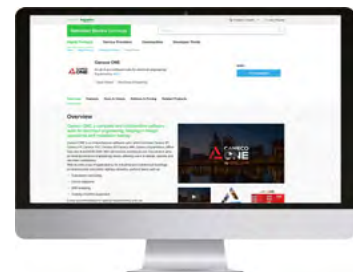

[Caneco ONE](#)



In one guide, access the information you need to help verify your electrical distribution design's short circuit and overload robustness. [The Selectivity, Cascading and Coordination Guide](#) provides information about how to optimize your power system.

# 03 Electrical asset management

We can help you monitor and visualize your critical electrical assets using a blend of digital technologies, remote expertise, and on-site maintenance. Through our customizable service offerings that help increase reliability, cost-efficiency, and enhance asset lifecycle management, you can choose to do some of the monitoring yourself, or let us do it for you, leveraging 24/7 remote expertise, a chat function and customized reports.



# Operational intelligence

Many organizations are still not taking advantage of the latest advances in power distribution connectivity and intelligence, some of which may already be in place in their facilities. Without this crucial last step, facility teams are working blind, unaware of many hidden risks, as well as numerous opportunities to maximize power availability and reliability for customers.

A resilient electrical system design is a minimum requirement – as an intelligent, digital infrastructure embedded in the electrical equipment, and connected to specialized power management software is also necessary. Only then will your customers have the foresight and actionable insights they need to help avoid unplanned power disruptions and helps ensure more reliable operations. Easy-to-use power management software applications help local personnel operate reliably and minimize disruptions through:

- Electrical monitoring and alarming
- Breaker settings monitoring
- Capacity management
- Power quality monitoring

Schneider Electric's EcoXperts™ collaborate to deploy all-in-one solutions and services across various applications and technologies that are designed to help reduce risk and cost. EcoXpert installations are delivered on time and on budget, to help facilitate reduced maintenance costs and improved productivity.

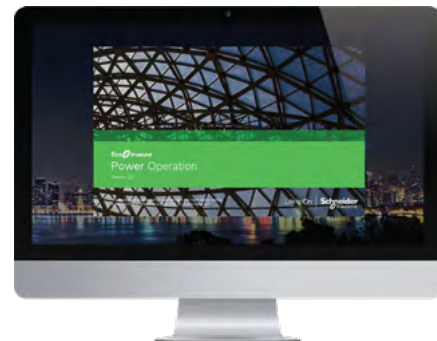

## [EcoStruxure Power Operation Demo](#)

The power of SCADA is uniquely designed for critical power management. Power Operation is engineered to help facilities maximize uptime. Try our comprehensive, end-to-end power management solution, highlighting operational intelligence capacities.

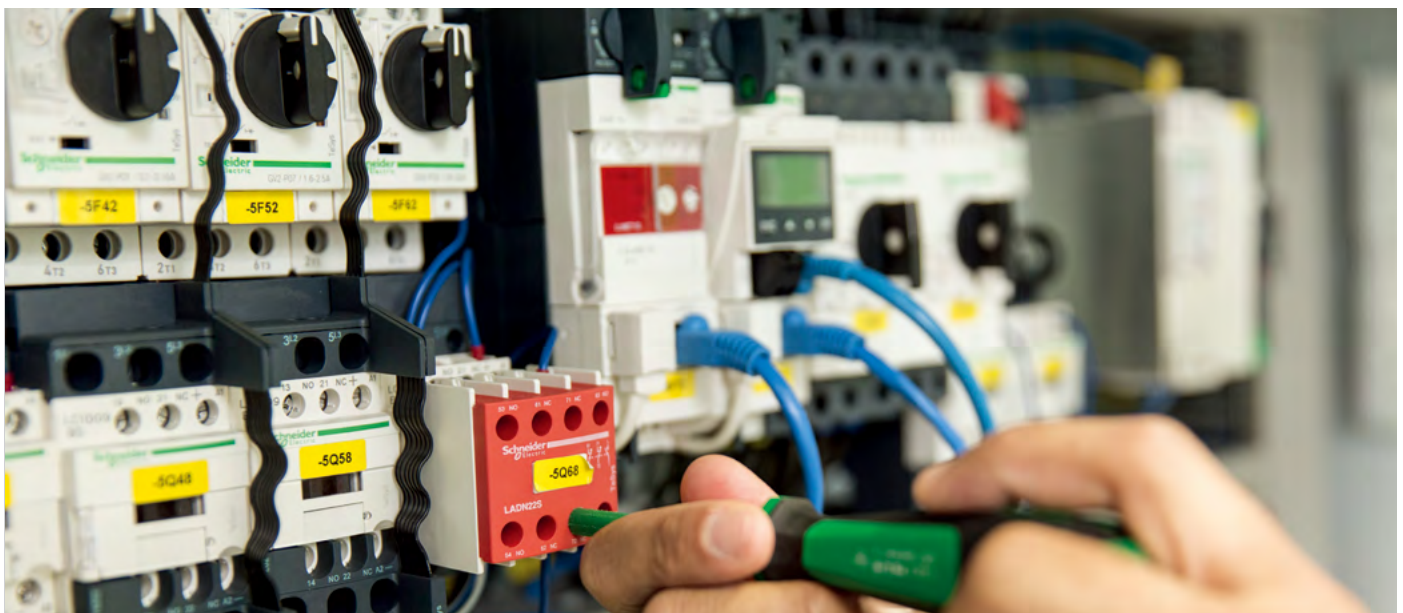

# Electrical system monitoring and alarming

Help prevent downtime, increase electrical system reliability, and better protect assets with self-healing medium voltage (MV) loop architectures, and by connecting MV relays, low voltage (LV) breakers, thermal sensors, and power meters to power monitoring and control software to:

- Isolate faults with relay automation and breaker coordination.
- Preserve critical loads by automatically transferring to alternate power sources and by shedding non-critical loads.
- Restore power more quickly and securely using electrical diagnostic information and remote control of breakers.

Get real-time visibility, automation, and control of your entire electrical infrastructure from MV to LV to final distribution to every load.

**EcoStruxure™  
Power Monitoring  
& Control Solutions**

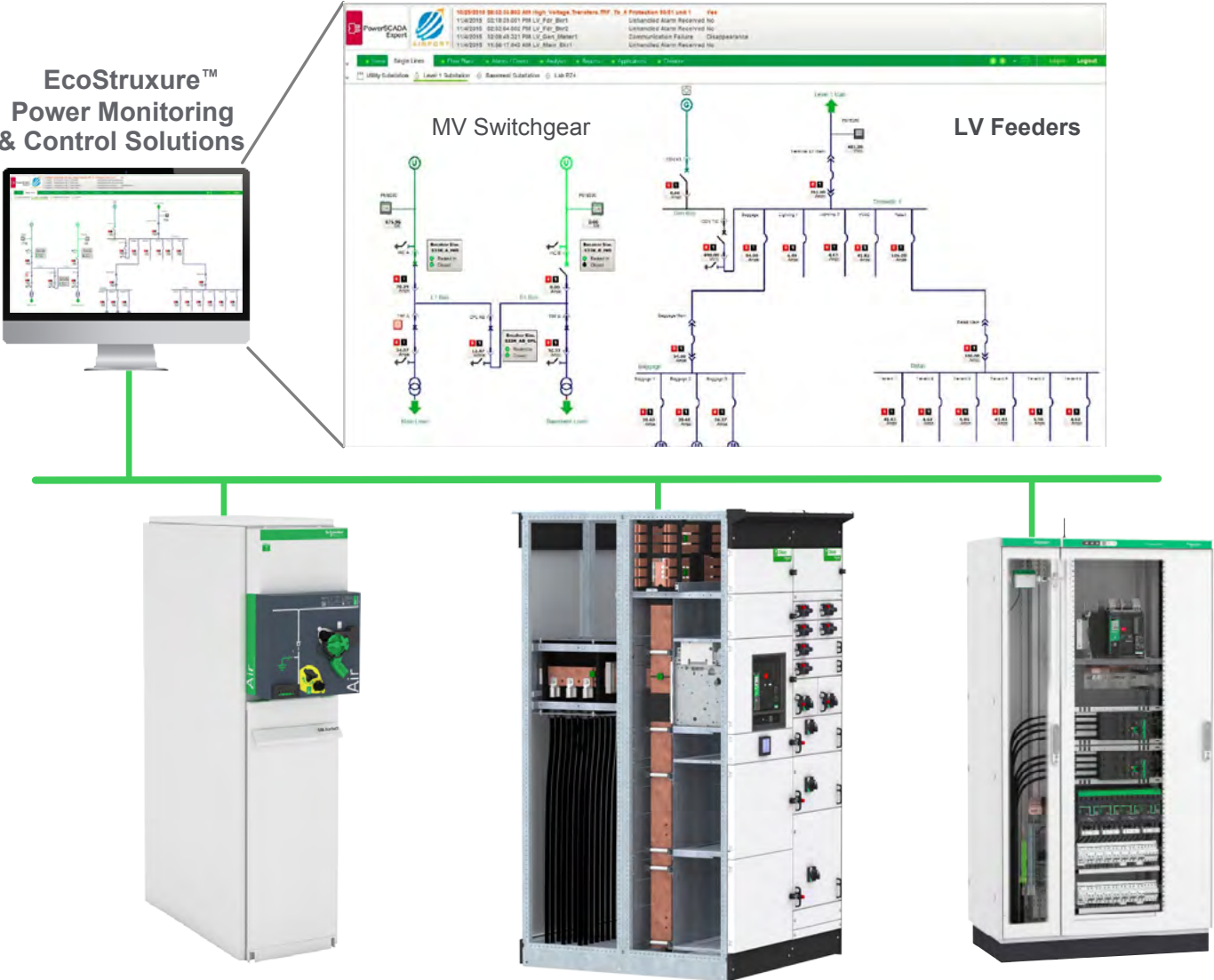

# Capacity management

Help prevent downtime and increase electrical system and asset reliability by tracking system capacity. Capacity management can help prevent circuit overloads and further ensure a backup power system is able to handle loads in the event of a utility outage.

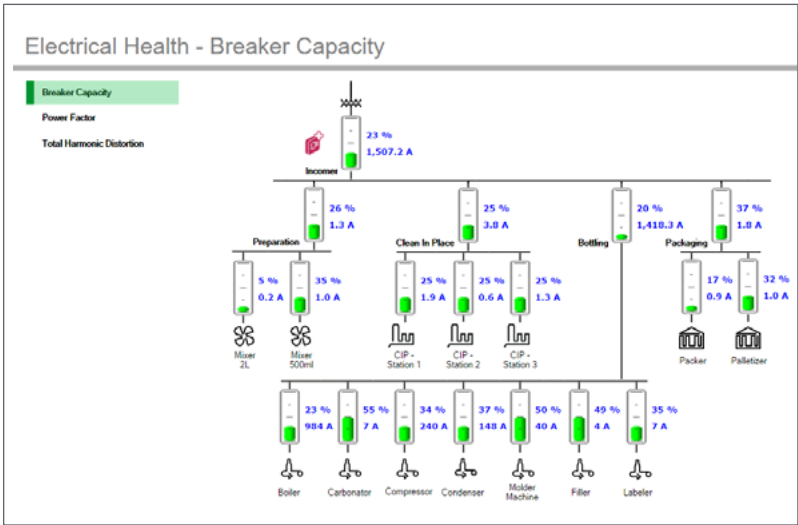
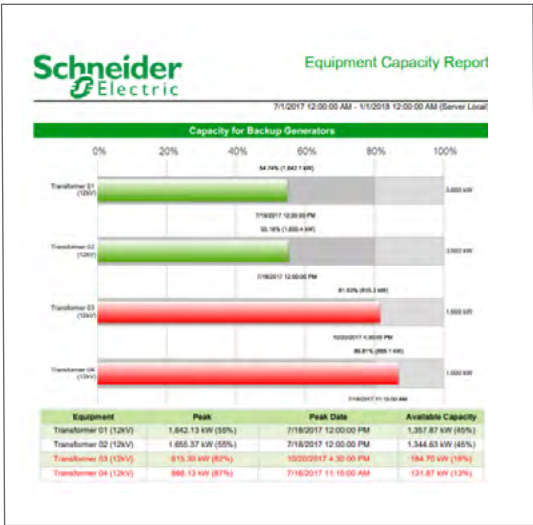
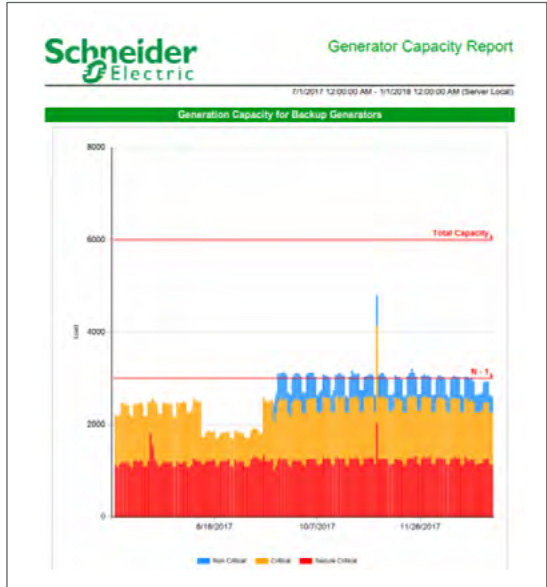
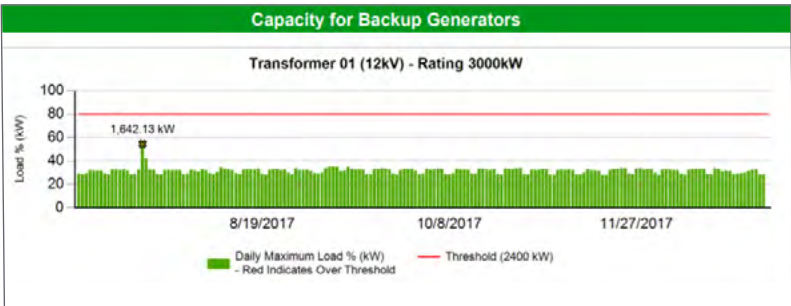

Sample reports for capacity management

# Breaker settings monitoring

Help prevent downtime and increase electrical system and asset reliability by monitoring circuit breaker protection settings to help ensure proper isolation of faults and to avoid system wide outages.

Automated Alerts



EcoStruxure  
Power Monitoring  
& Control Solutions



**A breaker setting  
has changed!**

**Schneider Electric** Circuit Breaker Settings Report

Circuit Breaker Inventory Johnson Building

Auxiliary Switchboard									
Breaker Name	Type	Protection Type	Serial Number	Protection Standard	Rated Voltage	Rated Current	Rated Frequency	Number of Poles	Date of Data Reading
CB 1	MiniLogic II	40	07142044	NA	NA	100	50/60Hz	3Pole	5/22/2019 11:18:36 AM
CB 2	MiniLogic X	1.5 & 5kA	N/A	IEC	400	100	50Hz	4Pole	5/22/2019 11:18:37 AM
CB 3	CompactNSX	N/A	N/A	UL	NA	NA	N/A	3Pole	5/22/2019 11:18:38 AM

Main Switchboard									
Breaker Name	Type	Protection Type	Serial Number	Protection Standard	Rated Voltage	Rated Current	Rated Frequency	Number of Poles	Date of Data Reading
CB 1	MiniLogic II	40	07229119	NA	NA	1250	50/60Hz	3Pole	4/22/2019 11:18:38 AM
CB 4	MiniLogic X	1.5 & 5kA	N/A	IEC	400	3000	50Hz	3Pole	5/22/2019 11:18:38 AM
CB 5	MiniLogic X	5.5 & 5kA	N/A	IEC	251	1250	50Hz	3Pole	5/22/2019 11:18:39 AM

Value has changed since the baseline date of 4/1/2019 12:00:00 AM (Blackout Daylight Time)

Automated Audit Reports

# Power quality management

Resolve persistent electrical disturbances by monitoring harmonics, unbalance and flicker, in addition to over/under voltage conditions. Capture and study event details such as waveforms and use patented Disturbance Direction Detection to pinpoint the directionality of events. Trend and report on power quality issues in order to understand potential problems that could affect operations, while leveraging the benefits of recurring expert advice with analytics advisory services to correct issues and help improve performance across your system.

## Symptoms of poor power quality

- Data loss
- Unexpected equipment shutdown
- Circuit board failures
- Reduced electrical system capacity
- Contactors dropping out
- Network communication issues
- Circuit breakers tripping
- Flickering lights
- Transformers humming
- Malfunction of controllers
- Premature motor failure
- Electrical cables running hot

Cloud-based electrical network health analytics and service bureau recommendations to improve



Advisor Services

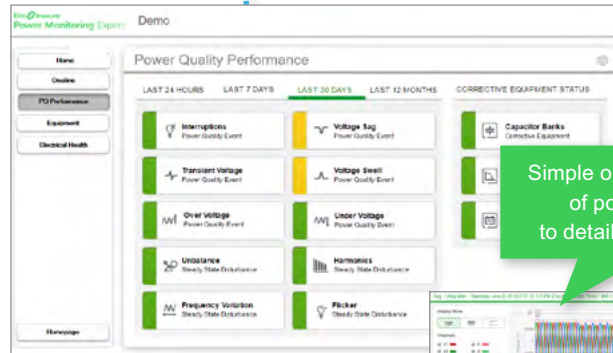

Simple on-premise interpretation of power quality issues to detailed waveform analysis

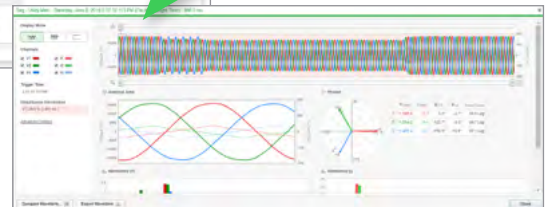

Edge Control Software



Connected products: power meters, MV protection relays, circuit-breakers, etc.

# Preventive maintenance and predictive approach

In the past, circuit breaker service and maintenance was typically reactive or preventative. Reactive (or corrective) action occurs only when devices fail. Preventative action happens at pre-determined, periodic maintenance intervals, normally 1 to 2 years, or in some cases when predefined thresholds are reached. Preventative approaches were adopted in an effort to increase the mean time between failures (MTBF) and, in turn, help maximize safety and avoid unnecessary facility downtime.

To further improve the MTBF and simultaneously, optimize maintenance costs, organizations are examining how to transform their circuit breaker maintenance strategies.

A condition-based, predictive approach can tailor the time intervals between inspections, servicing, or replacement. Intervals are determined based on the type of circuit breaker, operating conditions, and the financial goals of the facility. The premise of this strategy is to create predictive models that represent breaker aging and associated failure risks. These models are based on a variety of operational and environmental parameters.

By implementing these predictive models using available sensor and software technologies, facility teams can track risks in real-time, as well as generate automated reports that indicate circuit breaker health and whether there is a need for maintenance or replacement. This information helps:

- reduce the risk of failure, which can improve safety and avoid downtime
- improve the efficiency of maintenance services and, in turn, optimize

## Add-on sensors to decrease risks

To reduce the risks of electrical fires in MV and LV switchboards, transformers and busways, continuous thermal monitoring is possible and recommended with sensors.

Continuous thermal monitoring helps to prevent electrical fires with:

- Early detection of faulty connections
  - Monitors the temperature of busbar, cable, transformer, and withdrawable circuit breaker connections
  - Detects temperature deviations from normal operating conditions before they result in equipment failure
- Temperature alarming and reporting for faster response
  - Sends pre-alerts and alerts in case of abnormal temperature rise
  - Enables easy reporting of the thermal status of the electrical installation



This paper explores how IoT and analytic technologies can enable a condition-based, predictive approach for circuit breakers that can increase safety and reliability while optimizing maintenance costs.



HeatTag is an innovative smart sensor able to analyze gas and particles in the switchboard and alerts before any smoke or insulator browning occurs.



# Digital considerations

## Cybersecurity

In applications where power availability is critical to business operations, cybersecurity should be considered when designing a digitized power distribution system.

Schneider Electric follows the requirements in the IEC 62443 standard which is designed for operational technology systems, such as automation and facility systems like connected mechanical and electrical systems. For more information on cybersecurity in power distribution systems, refer to white paper [Understanding cybersecurity for IoT-enabled electrical distribution systems](#).



## Communication protocols

EcoStruxure Power relies on connected products using common industrial communication protocols such as:

- Modbus RTU (RS485 serial)
- Modbus TCP/IP
- DNP3
- IEC 60870-104
- IEC 61850
- Open wireless protocols (e.g., Bluetooth, Zigbee)

Schneider Electric's digitally-connected products natively support such protocols, edge control software and cloud-based digital service platforms such as EcoStruxure Power Advisor and EcoStruxure Asset Advisor which natively integrates power, energy, and diagnostics data for visualization and analysis.

## Data recording, time stamping, and time synchronization

When data is utilized for decision-making by building or facility operations and maintenance, ensuring the data can be relied upon is essential. When it comes to electrical, energy and diagnostics data, having precise and consistent data across an entire electrical infrastructure should be considered.

Depending on the sophistication of devices in the system, and the desired outcome of the data, certain selections of devices should be made. The more data recording and time-stamping capabilities on board the device, helps to ensure a higher precision in the data to be analyzed by system software.

Such considerations for data recording and time stamping can be summarized as follows:

- All data recorded and timestamped on board (such as with advanced power meters like PowerLogic ION9000 or PM8000)
- Only event and alarm data recorded and timestamped on board (such as embedded metering in Easergy protection relays or MasterPact MTZ circuit breakers)
- No on-board logging; real-time data only (such as basic energy meters like PowerLogic PowerTag). Data recording and timestamping are performed by a data logger or edge control software.

Time synchronization across devices in the system should also be considered. This can be done using a variety of architectures and protocols. Refer to the [EcoStruxure Power Time Synchronization Technical Guide](#) for more details.



# 04 Fault localization, root cause analysis, and power recovery

Knowing how complex electrical power systems can be, and understanding how vital their reliable, safe and efficient operation is to the business model of virtually every industry and organization, it has never been more important to be able to detect and locate electrical installation faults.



# Fault localization, root cause analysis

## The role of an EcoStruxure Power Monitoring & Control solution

To help prevent downtime, increase electrical system reliability, and better protect assets with self-healing medium voltage (MV) loop architectures and by connecting MV relays, LV breakers, and power meters to Power Monitoring and Control solutions

- Isolate faults with relay automation and breaker coordination
- Preserve critical loads by automatically transferring to alternate power sources and shedding non-critical loads
- Restore power more quickly and securely by using electrical diagnostic information and remote control of breakers

Get real-time visibility, automation, and control of your entire electrical infrastructure from MV to LV, to final distribution for every load.

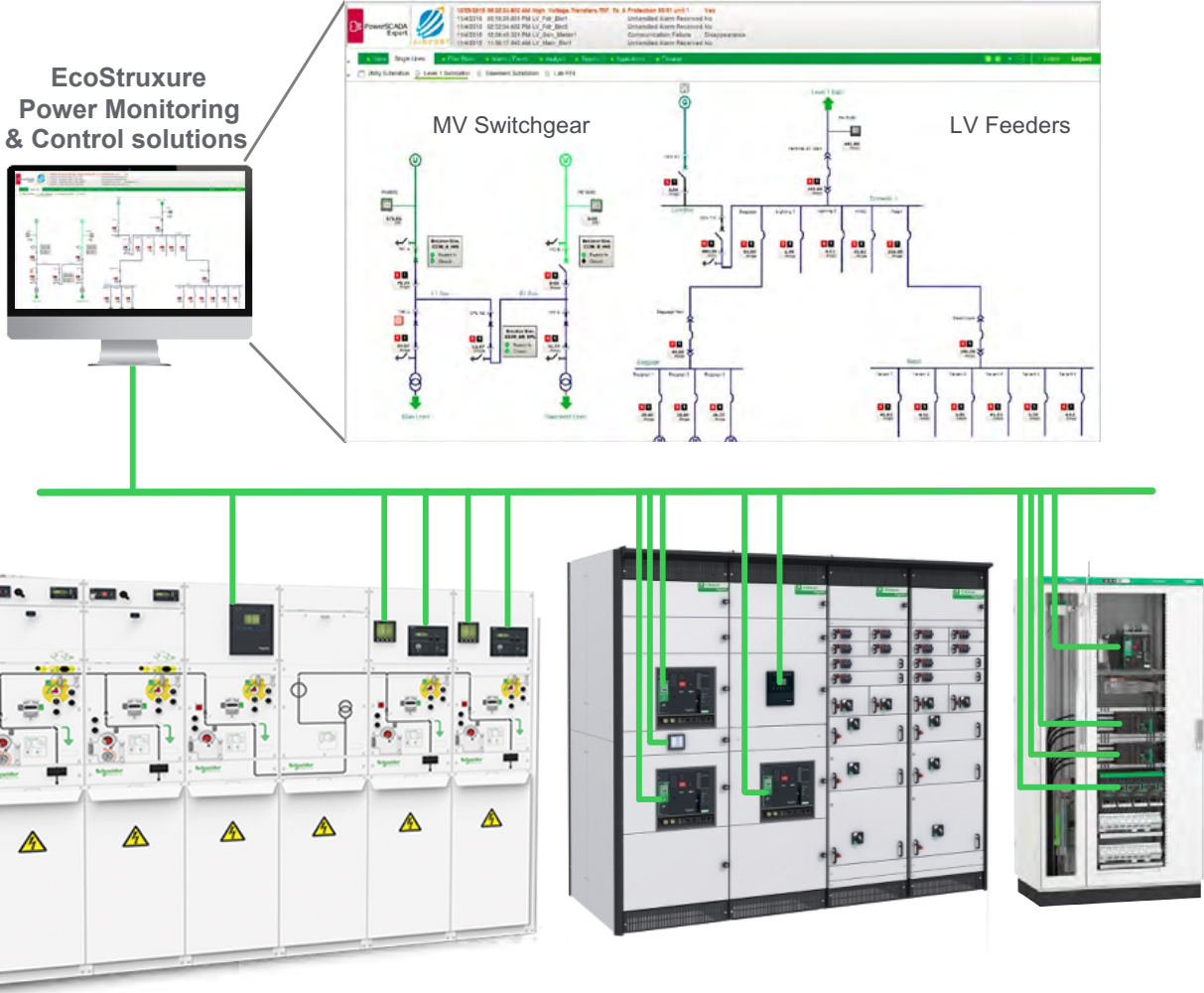

### Role of fault locator in ungrounded IT network

Detect and locate faults in ungrounded networks with insulation monitoring. Minimize downtime and optimize maintenance using insulation monitoring and fault location devices to detect and locate electrical faults in specialized ungrounded IT networks.

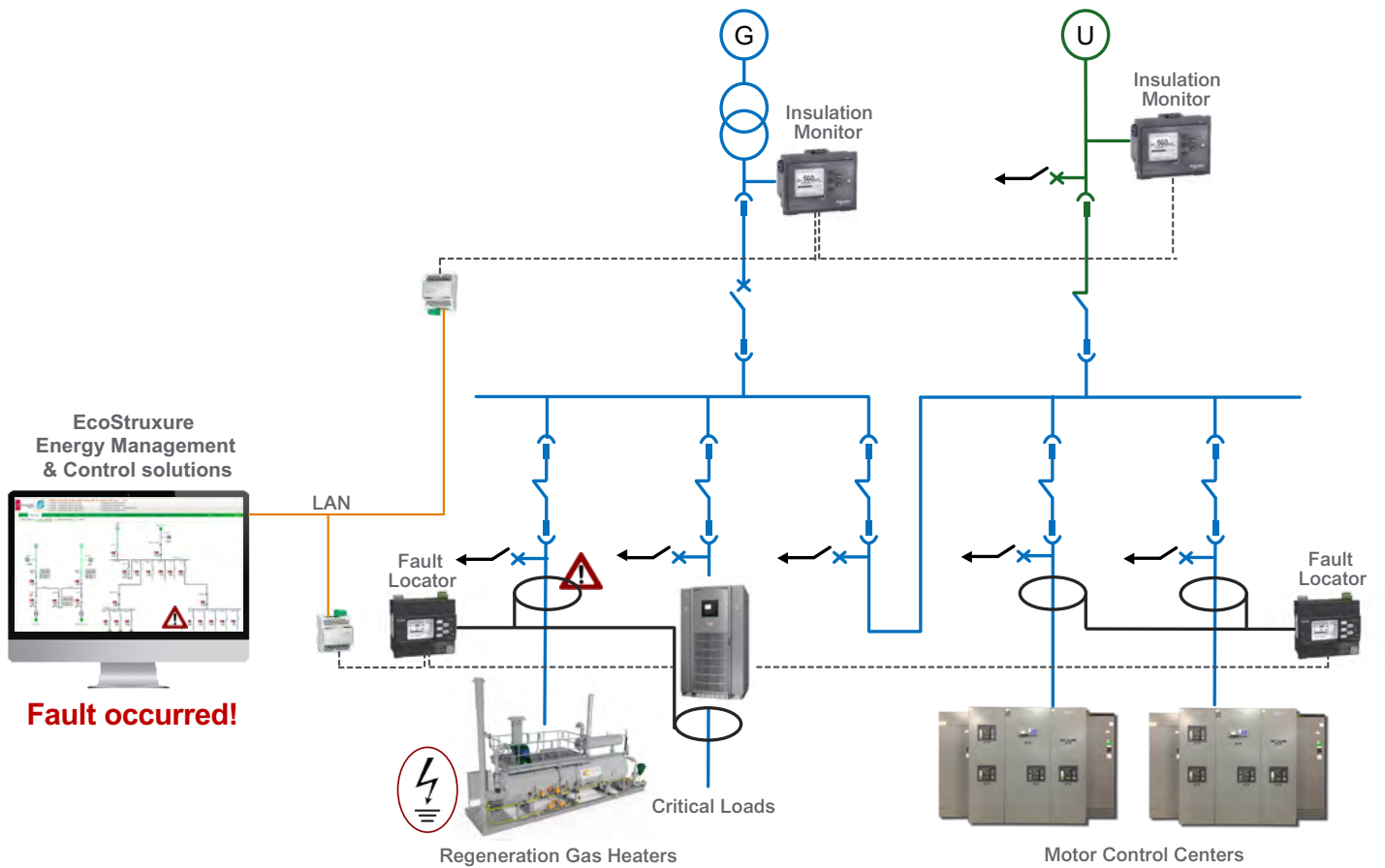

# Power event analysis for faster diagnosis of electrical problems

Help prevent downtime and increase electrical system and asset reliability through the use of specialized power event diagnostic tools. Use disturbance direction detection to determine the root cause of problems so you can make faster decisions with confidence and recover from faults more quickly.

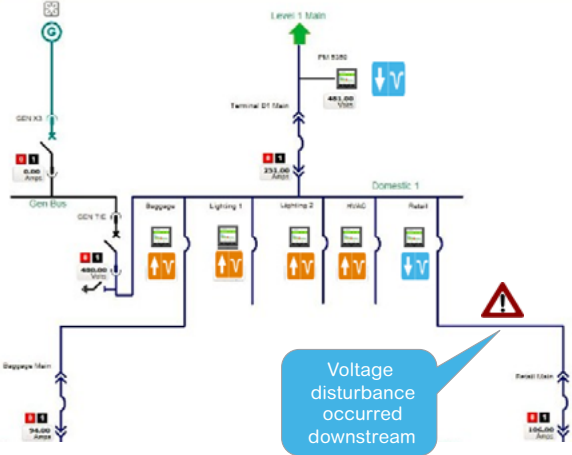

Power event analysis



# EcoStruxure™ Power Device

Reduce troubleshooting time in a power outage event by 15%

The use of EcoStruxure Power Device, coupled with Digital Modules (\*) of MasterPact MTZ, will help you to reduce power outage event troubleshooting time by 15%.

You can better understand the event by identifying the root cause of the power shutdown with an easy, touchless NFC connection to the circuit breaker, even without power supply. Then, an interactive step-by-step power restoration guide will help you to quickly and more securely reclose your installation.

\* Digital Modules to be used as a Power Recovery Pack:  
Power outage restoration assistant + Operator assistant + Waveform capture



# Overview of downtime prevention devices

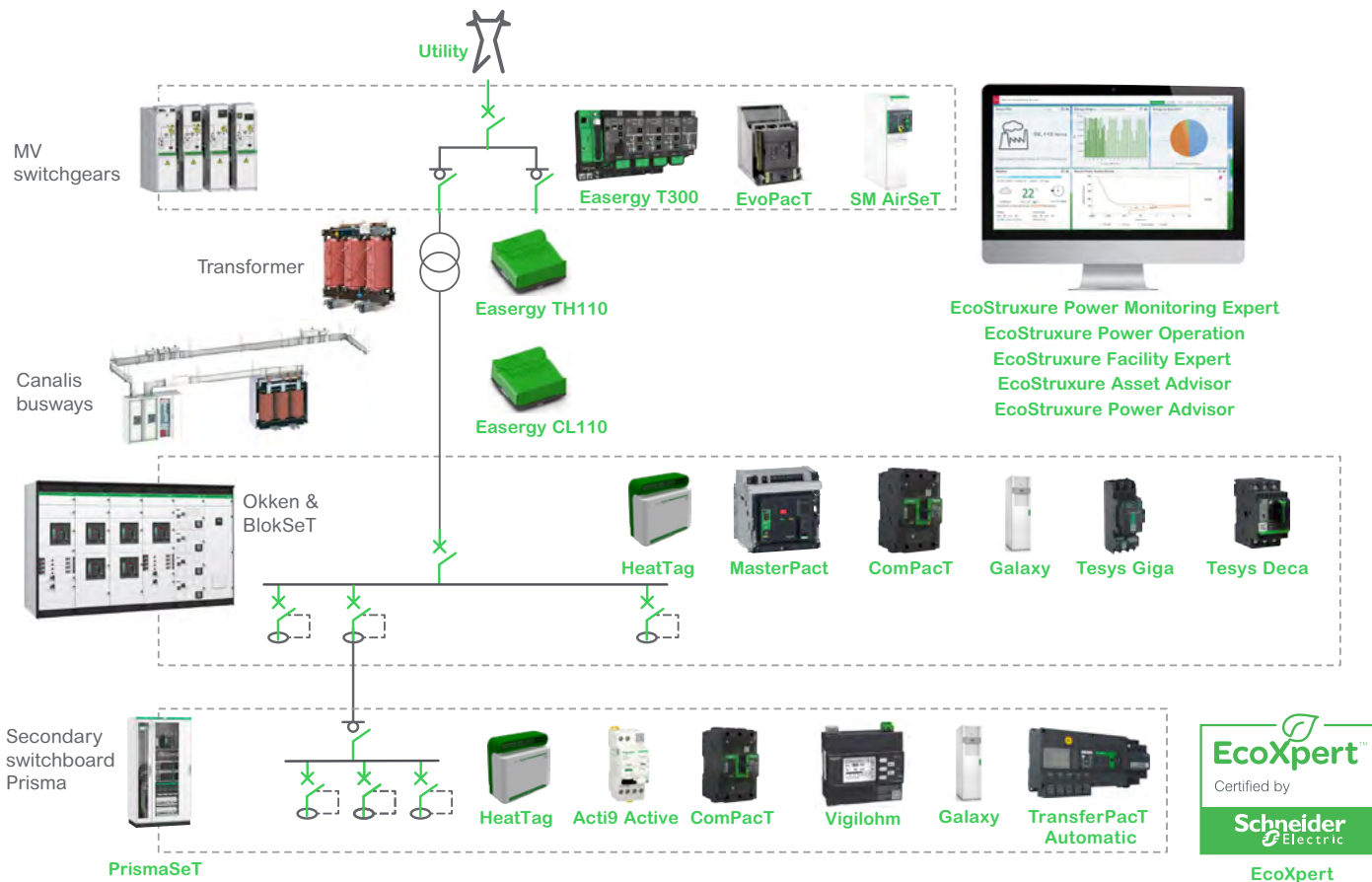



## Specifying for power availability and reliability

In addition to compliance to installation rules provided by specific national regulations (IEC 60364 as IEC reference), the following recommendations can be implemented to improve the power availability of an electrical network

Define the criticality of each load and the associated techniques to help to secure those that are most vital (Genset backup, double ended supply, UPS, etc.).

Select IEC 61439 compliant switchboards, and consider their Service Index (SI), taking into account their operational, maintenance, and adaptation requirements.

Consider adding an arc flash system to help minimize the impact of arc flashes and to speed recovery.

Contemplate the use of IT system as an earthing system to avoid tripping due to earth fault (1st default). This can be enhanced with fault localization through an Isolation Fault Monitor.

Choose residual current devices according to the type of load (example: A type SI if protecting IT loads or if there is a risk of lightning, B type if for an EV charger).

Ensure coordination between the surge protective device and its disconnect circuit breaker.

Perform a selectivity study (on overcurrent and earth fault current), select and set products according to the study. Note: it is mandatory for safety-related loads as per IEC 60364 standard, and highly recommended for any critical load.

Make sure an enhanced selectivity feature is provided in case both selectivity and cascading are implemented.

Implement motor protection coordination type 2 where continuity of service is imperative and/or maintenance services are limited.

Think about systems raising the alarm before a fault occurs (e.g., pre-alarm on a thermal relay or residual current device, self-diagnostic indicator).

Implement power quality monitoring (e.g., voltage level, harmonics, power factor, etc.) according to load sensitivity (e.g., electronics and IT technology are highly sensitive).

Consider the use of filters, drives or soft-starters, and capacitors to reduce the stress on electrical equipment.

Add a monitoring system and link it to each electrical asset to observe the entire electrical system, track status changes, build a preventive maintenance plan and ultimately, if any power outage occurs, trigger alerts and localize faults correctly.

Install continuous thermal monitoring on MV/ LV switchboards, transformers, and busways.

Install a detection system to identify abnormal temperature rise in switchboards based on gas and particles emitted by conductor insulation material.

Consider adding a monitoring system, even in small and medium-sized buildings that have sensitive and/or critical loads. There are simple solutions compatible with mobile devices.

Consider troubleshooting tools to help recover faster from a power outage.

Maintain UPS, Automatic Transfer Switches, circuit breakers, contactors, switchboards, and all equipment involved in power supply maintenance according to each manufacturer's recommendations.

### Segment specific

Hospital: select IEC 60364-7-710 as a reference.

Look for proved and accepted reference architectures optimized for segment requirements.





### Services

Use the advanced diagnostic tools and software provided by expert service providers to identify infrastructure weakness and help prevent unplanned shutdowns, improve the performance and availability of your overall electrical system.

Train personnel to conduct maintenance operations.



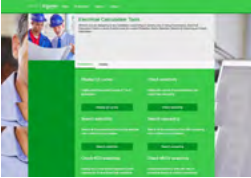



# Apps, analytics & services

Offer	What it does
<p><b>Design software</b> EcoStruxure™ Power Design – Ecodial</p>	<p>User-friendly software that helps optimize your equipment and costs, while managing operating constraints during the electrical installation design phase of your project.</p> <p>The software helps make electrical installation design easier through simple single-line diagram drawing, and defining properties such as load power, polarity, earthing system arrangement, cable length, and operating conditions.</p>
<p><b>Electrical installation design tool</b> EcoStruxure™ Power Design - Calculation Tools</p>	<p>An online electrical calculation assistant offering 7 tools designed to:</p> <ul style="list-style-type: none"> <li>• Display the time-current curves of 1 to 8 circuit breakers</li> <li>• Check the discrimination between two circuit breakers and display their time-current curves</li> <li>• Search all circuit breakers that can be selective with a defined circuit breaker</li> <li>• Search all circuit breakers that offer cascading with a defined circuit breaker</li> <li>• Display the curves of two Residual Current Devices (RCDs) and check their discrimination</li> <li>• Calculate the cross section area of cables and build a cable schedule</li> <li>• Calculate the voltage drop of a defined cable and check its maximum length</li> </ul>
<p><b>Asset performance management digital services</b> EcoStruxure™ Asset Advisor</p>	<p>Obtain a 24/7 cloud-enabled monitoring service for your critical equipment. Increase resiliency and transparency with the assistance of service personnel equipped with real-time device data to quickly troubleshoot issues and dispatch technical expertise. With just one tap, the EcoStruxure IT app gives you access to your assets, incident tracking, and online chat collaboration to keep you in touch with Schneider Electric and your team.</p>
<p><b>Proactive power management system</b> EcoStruxure™ Power Advisor</p>	<p>EcoStruxure Power Advisor raises metering diagnostics from device-based troubleshooting to full system analysis. It combines expert advice with advanced algorithms – applying it to data from your Power Monitoring Expert system – to identify gaps or issues in your power management system, as well as power quality issues within your larger electrical distribution system.</p>
<p><b>Services</b> Schneider Electric Services Everywhere</p>	<p>24/7 condition monitoring of critical parts, cloud platform, smart notification, alarm and preventive maintenance (Combo: Trihal, SM AirSet and Prisma, EcoStruxure Asset Advisor).</p>

Power availability and reliability support for:				Click to learn more about the solution	Watch the solution in action	Supplemental resources
Digital and power system reference designs	Selectivity	Electrical asset management	Fault localization, root cause analysis, and power recovery			
✓	✓					
	✓					
		✓				 Brochure
		✓				
		✓	✓			





# Edge control

Offer	What it does
<p><b>Facility management software</b></p> <p>EcoStruxure™ Facility Expert</p>	<p>Speed access to your asset information.</p> <p>A digital logbook help ensure the availability and sharing of project lifecycle documentation, including single-line diagrams, maintenance plans, and more.</p> <ul style="list-style-type: none"> <li>• Create and scan QR codes to track assets for long-term maintenance schedules and task reminders.</li> <li>• Log and access asset history, documentation, and collaborative information with one simple scan.</li> <li>• Generate inspection and activity reports on the spot.</li> <li>• Facilitate easier preventative maintenance to help reduce the risk of downtime.</li> </ul> <p>Address potential issues ahead of time, every time, thanks to:</p> <ul style="list-style-type: none"> <li>• Long-term maintenance schedules</li> <li>• Convenient reminders and planning capabilities</li> <li>• Access to historical equipment data</li> <li>• QR code-based functions</li> </ul>
<p><b>Power monitoring expert</b></p> <p>EcoStruxure™ Power Monitoring Expert</p>	<p>Award-winning EcoStruxure Power Monitoring Expert (PME) is designed to help power-critical and energy-intensive facilities maximize uptime and operational efficiency.</p> <p>A key element of PME is the window into your digitized power network. It leverages IoT connectivity and distributed intelligence to provide the flexibility and adaptability needed for both today and for an expanding IoT-enabled future.</p> <p>As power grid technology becomes more dynamic, systems more complex, and regulations more challenging, PME brings unique new capabilities that make it simpler to improve facility uptime and operational efficiency.</p>

Power availability and reliability support for:				Click to learn more about the solution	Watch the solution in action	Supplemental resources
Digital and power system reference designs	Selectivity	Electrical asset management	Fault localization, root cause analysis, and power recovery			
		✓	✓			 <b>Brochure</b>   <b>White Paper</b>
		✓	✓			 <b>Demo</b>

# Edge control











Offer	What it does
<p><b>Power operation control software</b></p> <p>EcoStruxure™ Power Operations</p>	<p>EcoStruxure Power Operation is engineered to help facilities like data centers, hospitals, industrials, airports and electro-intensive operations maximize uptime.</p> <ul style="list-style-type: none"> <li>• Quickly understand the real-time status of your power system.</li> <li>• Use real-time alarm notifications, filtering, sorting, and categorization to respond more quickly to events.</li> <li>• Perform root cause analysis by tracing the sequence of events, analyzing waveforms, then quickly and more securely improve facility uptime and operational efficiency. Securely re-establish normal operation.</li> <li>• Perform fast, automatic fault isolation and power restoration.</li> <li>• Monitor protection settings to help ensure proper isolation of faults to avoid system-wide outages.</li> <li>• Analyze the aging of breaker contacts to avoid failures and enable proactive maintenance.</li> <li>• Track system capacity to avoid overloads and make sure backup power systems can handle loads in case of an outage.</li> </ul>
<p><b>Power grid digital control system</b></p> <p>EcoStruxure™ Power Automation System</p>	<p>Energy transition, distributed generation, and renewables make today's power grids increasingly complex, driving the need for digital transformation. EcoStruxure Power Automation System helps monitor, operate, and maintain these electrical systems with future-proof technologies like IEC 61850, which revolutionizes the way we digitize, design, configure, and maintain the power grid, and IEC 62443, the cybersecurity standard that supports security-by-design practices.</p>

Power availability and reliability support for:				Click to learn more about the solution	Watch the solution in action	Supplemental resources
Digital and power system reference designs	Selectivity	Electrical asset management	Fault localization, root cause analysis, and power recovery			
		✓	✓			 Demo
		✓	✓			

# Connected products



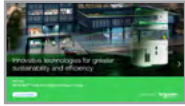



Offer	What it does
<p><b>Remote terminal unit</b></p> <p>PowerLogic Easergy T300</p>	<p>PowerLogic Easergy T300 is a smart grid-ready remote terminal unit (RTU) that is engineered for feeder automation, electrical distribution network, and distribution automation challenges. Minimize power supply interruptions and manage increasing energy demand.</p> <p>Easergy T300 helps improve system average interruption duration index (SAIDI) and optimize MV and LV networks:</p> <ul style="list-style-type: none"> <li>• Detect MV faults from current and voltage measurements to reduce outage time</li> <li>• Reconfigure the network automatically after a fault (in centralized or decentralized architectures)</li> <li>• Reduce LV outage durations</li> </ul>
<p><b>MV protection relay</b></p> <p>PowerLogic Easergy P5</p>	<p>Easergy protection relays and feeder automation devices offer a new standard for modern electrical distribution management. With Easergy, powerful smart grid applications become digitally connected. Leverage the industry-leading functionality in protection, monitoring, and control to improve the efficiency and reliability of your electrical network.</p> <p>Easergy P5 presents a major step forward for protection relays, bringing the most desirable features together in one device. It brings industry-leading protection and control functions with built-in arc-flash protection, latest cybersecurity, and nearby operation with a mobile application.</p> <p>Easily withdraw design for quicker maintenance:</p> <ul style="list-style-type: none"> <li>• Backup memory function enabling industry-leading 10-minute recovery time.</li> <li>• Condition monitoring for reduced risk of power outages and maximized equipment life.</li> <li>• Extended equipment lifetime when used with EcoStruxure Asset Advisor.</li> </ul>
<p><b>MV switchgear</b></p> <p>SM AirSeT</p>	<p>Revolutionary SM AirSeT MV switchgear marks a bold move away from SF6 gas to the ideal gas: pure air. It draws from the legacy of the established SM6 switchgear, with an installed base that exceeds 1.5M, and uses proven and more reliable vacuum technology, while keeping all functionalities and connectivity for a no-compromise switchgear solution.</p>
<p><b>MV breakers and switches</b></p> <p>EvoPacT</p>	<p>World-class circuit breakers, switches, disconnectors, contactors and fuses. Providing reliable switchgear components with peace of mind to panel builders and users in any MV applications up to 40.5 kV.</p>



Power availability and reliability support for:				Click to learn more about the solution	Watch the solution in action	Supplemental resources
Digital and power system reference designs	Selectivity	Electrical asset management	Fault localization, root cause analysis, and power recovery			
		✓	✓			 Catalog
✓	✓	✓	✓			 Catalog
✓		✓			 	 Brochure
✓						









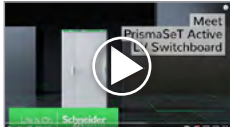

# Connected products

Offer	What it does
<p><b>Transformer</b> Trihal</p>	<p>Cast resin distribution transformers offer up to 24/7 condition monitoring of critical parts, and support cloud connectivity, smart notification, alarms, and preventive maintenance (Combo: Trihal, SM AirSeT and Prisma, EcoStruxure™ Asset Advisor).</p>
<p><b>Smart sensor</b> PowerLogic Easergy TH110 &amp; CL110</p>	<p>Easergy TH110 is a self-powered, wireless sensor monitor that provides thermal data of your cable connections. Thermal monitoring gives you on-demand insight into the health of your switchboard's components. The CL110 additionally acts as a humidity sensor. They both help ensure the installation's monitoring to maximize your uptime.</p>
<p><b>Power distribution switchboard</b> Okken</p>	<p>Okken switchboards provide singular advantages for enhancing power availability and reliability:</p> <ul style="list-style-type: none"> <li>• 'Install-and-forget' dependability</li> <li>• Resistance to corrosive environments (e.g., tough enough for the harshest Oil &amp; Gas applications)</li> <li>• Optimized for marine installations</li> <li>• Durability for seismic areas</li> <li>• With thermal monitoring to provide unique insight into the internal status of the switchboard</li> </ul>
<p><b>Power distribution switchboard</b> BlokSeT</p>	<p>BlokSeT smart switchboards are pre-equipped with thermal sensors that can perform thermal inspections and send information to smartphones and tablets to complement, or even replace, Infrared scans.</p> <p>EcoStruxure™ Power Edge Control (PME/PSO) w/SMD and thermal sensors make it possible to monitor power system status 24/7 in real-time, and set alarms for excessive temperature on critical points in LV switchboards.</p>

Power availability and reliability support for:				Click to learn more about the solution	Watch the solution in action	Supplemental resources
Digital and power system reference designs	Selectivity	Electrical asset management	Fault localization, root cause analysis, and power recovery			
✓		✓				
✓		✓				
✓		✓				
✓		✓				

# Connected products

Offer	What it does
<p><b>Switchboard</b> PrismaSeT Active</p>	<p>PrismaSeT Active switchboards come with an integrated LPWAN gateway in the panel, allowing you to connect up to 15 wireless sensors to the cloud. The feature is standard with PrismaSeT P Active, and is optional in PrismaSeT G Active when wall-mounted.</p> <p>This revolutionary approach provides native connectivity to the cloud and lets any customer, in any commercial building, give their electrical distribution a voice. It helps to optimize maintenance, save energy, and increase uptime.</p>
<p><b>Smart sensor</b> PowerLogic HeatTag</p>	<p>Early detection of overheating cables to help ensure the installations monitoring to maximize your uptime.</p> <p>HeatTag is an innovative smart sensor, able to analyze gas and particles in the switchboard and alert before any smoke or insulator browning occurs.</p>
<p><b>UPS</b> Galaxy V Series</p>	<p>The Galaxy V series, 3-phase UPS delivers top performance for edge, small, and medium-sized data centers, critical IT, commercial, and industrial facilities.</p> <p>It meets internal redundancy needs with N+1 power modules that multiply by a factor of 10, to improve the system's availability without the extra footprint.</p> <ul style="list-style-type: none"> <li>• It provides an option to use lithium-ion batteries, to benefit from longer battery life, and higher temperature tolerances than classic battery solutions.</li> <li>• Maximizes availability while minimizing the total cost of ownership.</li> <li>• Highly efficient patented technology delivers up to 97% in normal operating mode and up to 99% efficiency in EConversion mode — a 66% improvement in energy savings over its predecessor.</li> </ul>

Power availability and reliability support for:				Click to learn more about the solution	Watch the solution in action	Supplemental resources
Digital and power system reference designs	Selectivity	Electrical asset management	Fault localization, root cause analysis, and power recovery			
✓		✓	✓			 <p>Application Notes</p>
✓		✓			 	  <p>Technical Leaflet</p> <p>Brochure</p>
✓		✓			 	

# Connected products

Offer	What it does
<p><b>Automatic transfer switch</b></p> <p>ASCO Power Automatic Transfer Switches</p>	<p>ASCO Power Automatic Transfer Switches are the standard of the industry. High-speed transfer of loads between alternate sources of power, regardless of ampacity, is achieved using a more reliable, field-proven solenoid operating mechanism.</p> <p>They can provide delayed or closed transition modes of operation as needed, and can maintain power continuity, even during ATS maintenance. By-pass solutions are also available.</p>
<p><b>Transfer switch</b></p> <p>TransferPacT Automatic</p> <p>TransferPact Manual</p>	<p>For years Schneider Electric's source changeover systems have proven their reliability worldwide in most power-dependent buildings.</p> <p>The new TransferPacT Automatic:</p> <ul style="list-style-type: none"> <li>• Enables fast transfer to minimize power loss</li> <li>• Allows easy and cybersecure monitoring of critical loads</li> <li>• Provides the benefits of native coordination with upstream protection (see associated guide).</li> </ul> <p>ComPacT or MasterPact circuit breakers, the ultimate reference in industrial switchgear, can also perform transfer switching.</p>
<p><b>Contactors and Overload Relay</b></p> <p>Tesys Giga</p>	<p>TeSys Giga Contactors and TeSys Giga Overload Relays focus on large rating motor and power switching applications.</p> <ul style="list-style-type: none"> <li>• They are highly compact, modular, and offer full-scale protection with diagnostic functions 115-800A 3p &amp; 4p contactors and 28-630A electronic overload relays.</li> <li>• After a short circuit, type 2 coordination allows motor restarting with minimal maintenance.</li> <li>• Tips wear level indicator allows replacement before a contactor fails.</li> <li>• The relay alarms to anticipate an overload trip and enhance the continuity of service.</li> </ul>
<p><b>Variable speed drive</b></p> <p>Altivar Drives</p>	<p>A new concept in drives meets the vital needs of process industries and utilities with enhanced equipment efficiency and total cost of ownership through its support of energy management, asset management, and also overall process performance.</p> <p>Benefits include:</p> <ul style="list-style-type: none"> <li>• Sustainable cost savings thanks to predictive condition-based maintenance.</li> <li>• Up to 20% downtime reduction with no additional investment.</li> <li>• Combined with AccuSine, it can increase the lifetime of your equipment with fewer harmonics and less mechanical stress.</li> </ul>

Power availability and reliability support for:				Click to learn more about the solution	Watch the solution in action	Supplemental resources
Digital and power system reference designs	Selectivity	Electrical asset management	Fault localization, root cause analysis, and power recovery			
✓		✓				
✓	✓	✓	✓			
	✓	✓	✓			
✓		✓				

# Connected products













Offer	What it does
<p><b>Active harmonic filter</b> AccuSine PCS+, PCS</p>	<p>LED or CFL lights, computers, office loads, and variable speed drives, can all cause harmonic distortion, affecting 3-phase power and neutral cables. The adverse effects of harmonics can be costly, leading to data loss or corruption, and premature equipment failure.</p> <p>AccuSine PCS is an ideal solution for nonlinear loads. It mitigates harmonics in all 3-phases and neutral, in addition to providing power factor correction and mains current balancing. It can extend equipment life, and help boost reliability and efficiency in your electrical system.</p>
<p><b>Advanced power quality meter</b> PowerLogic ION9000</p>	<p>Discover the world's most innovative, most advanced power quality meter. Designed for those who demand the highest performance from their power networks.</p> <ul style="list-style-type: none"> <li>• PowerLogic ION9000 meters provide the precision and accuracy that is needed in the most demanding electrical environments.</li> </ul>
<p><b>Air circuit breaker</b> <b>MasterPact™ MTZ</b></p>	<p>MasterPact MTZ air circuit breakers combine scalability, durability, and connectivity, while incorporating the latest digital technologies to provide improved power uptime and energy efficiency.</p> <p>The range provides complete selectivity and coordination with complementary products.</p> <ul style="list-style-type: none"> <li>• The vast range of settings for the protection functions on MicroLogic X control units improves the natural coordination between circuit breakers.</li> </ul>



Power availability and reliability support for:				Click to learn more about the solution	Watch the solution in action	Supplemental resources
Digital and power system reference designs	Selectivity	Electrical asset management	Fault localization, root cause analysis, and power recovery			
✓						 Catalog
		✓	✓			 Brochure
✓	✓	✓	✓			 Digital Module Brochure  Range Brochure
						 Catalog







# Connected products

Offer	What it does
<p><b>Molded case circuit breaker</b></p> <p>ComPacT NS / NSX / NSXm</p>	<p>Equipped with auxiliary contacts and/or connected to a monitoring system such as EcoStruxure Facility Expert or EcoStruxure Power Monitoring Expert, information that a fault occurred and its localization is easy and extremely fast. Installation can be repaired quicker, and the consequences of downtime are reduced.</p> <p>Now available with wireless solutions, to enable quick integration in PrismaSeT Active. ComPacT NSXm is the smallest molded case circuit breaker in the ComPacT NSX range and supports complete selectivity and coordination that can be designed with our technical guide, or the <a href="#">EcoStruxure Power Design - Ecodial</a> and the <a href="#">EcoStruxure Power Design - Calculation Tools</a>.</p>
<p><b>Digital multifunctional load management system</b></p> <p>TeSys™ island</p>	<p>TeSys island is a digital load management solution that contributes to make machines smarter and more reliable. It is a fully digitized, object-oriented load management system, and an Industry 4.0 compliant data provider. TeSys island gives users easy, remote access to predictive and preventive application data to enable better early diagnostics and preventative maintenance. It can be easily integrated into Schneider Electric EcoStruxure Machine architectures and 3rd-party automation solutions with open communications via fieldbuses like EtherNet/IP, Modbus TCP, PROFINET, and PROFIBUS.</p> <ul style="list-style-type: none"> <li>• Detect issues such as starter end-of-life, dead motor, poor ventilation, reverse wiring, or fuse blow.</li> <li>• Monitor energy at load level, remote users can easily check health status, troubleshoot, diagnose issues, and take action.</li> </ul>
<p><b>Final distribution circuit breaker (AFDD+RCD+MCB)</b></p> <p>Active Safety System (Acti9 Active)</p>	<p>Acti9 Active provides all-in-one protection with advanced electrical system visibility. It comes with built-in connectivity to send alarms and pre-alarms on electrical faults. It also helps protect people, appliances, circuits and assets from earth leakage current, overload, overvoltage, and fire due to arc fault thanks to integrated residual current device (RCD), miniature circuit breaker (MCB), MSU, and arc fault detection device (AFDD). The system works to its full potential through a simple combination of the following three components:</p> <ol style="list-style-type: none"> <li>1. Acti9 Active (connected all-in-one protection breaker)</li> <li>2. EcoStruxure™ Power Monitoring Expert (power monitoring software)</li> <li>3. EcoStruxure Panel Server (advanced gateway)</li> </ol>

Power availability and reliability support for:				Click to learn more about the solution	Watch the solution in action	Supplemental resources
Digital and power system reference designs	Selectivity	Electrical asset management	Fault localization, root cause analysis, and power recovery			
✓	✓	✓	✓			 <p>Application Sheet</p>
		✓	✓			 <p>eGuide</p>  <p>Catalog</p>
✓	✓	✓	✓	 		 <p>Brochure</p>  <p>Hospital Application Sheet</p>

# Connected products

Offer	What it does
<p><b>Final distribution Accessories for circuit-breakers</b></p> <p>Remote Control Auxiliary (RCA) for iC60 circuit-breakers</p> <p>Automatic Recloser (ARA) for iC60 circuit breakers and iID residual current circuit breakers (RCCB)</p>	<p>Acti9 RCA for iC60 circuit breakers enables remote control in case of fault tripping.</p> <p>Acti9 ARA for iC60 circuit breakers and iID RCCBs senses fault currents in a power distribution box. It waits and re-energizes the line as long as the fault is transient. If the fault is permanent, it automatically locks into an open position</p>
<p><b>Insulation monitoring device</b></p> <p>PowerLogic Vigilohm</p>	<p>Monitoring a power network's insulation to earth helps improve system reliability. Our patented measurement principle – fully compliant with applicable standards – allows Vigilohm devices to accurately measure insulation resistance and network leakage.</p>
<p><b>Wireless energy sensors</b></p> <p>PowerLogic PowerTag®</p>	<p>PowerTag is a compact and easy-to-install Class 1 wireless communication energy sensor that monitors and measures energy and power in real-time.</p> <p>Designed for new or existing installations in the residential, small business, and commercial building segments, it sends alerts in the event of an electrical anomaly, so now, homeowners can enjoy peace of mind and business owners can boost operational efficiency and uptime.</p>

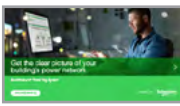
Power availability and reliability support for:				Click to learn more about the solution	Watch the solution in action	Supplemental resources
Digital and power system reference designs	Selectivity	Electrical asset management	Fault localization, root cause analysis, and power recovery			
			✓			
✓		✓	✓			 <p>Brochure</p>
		✓	✓	 	 <p>Customer Story</p>  <p>Brochure</p>	

Life Is On



To learn more about how to improve  
power availability and reliability visit:  
[se.com](https://se.com)

Schneider Electric  
35 rue Joseph Monier  
92500 Rueil-Malmaison, France  
Tel : +33 (0)1 41 29 70 00