

Easy UPS 3L

Receiving and Unpacking

3/2020

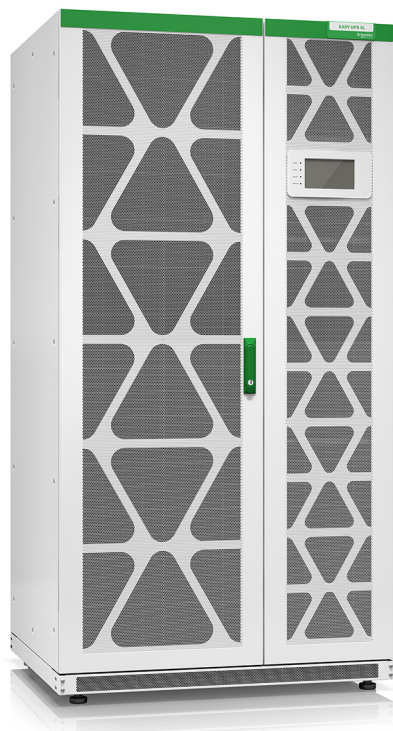

Legal Information

The Schneider Electric brand and any trademarks of Schneider Electric SE and its subsidiaries referred to in this guide are the property of Schneider Electric SE or its subsidiaries. All other brands may be trademarks of their respective owners.

This guide and its content are protected under applicable copyright laws and furnished for informational use only. No part of this guide may be reproduced or transmitted in any form or by any means (electronic, mechanical, photocopying, recording, or otherwise), for any purpose, without the prior written permission of Schneider Electric.

Schneider Electric does not grant any right or license for commercial use of the guide or its content, except for a non-exclusive and personal license to consult it on an "as is" basis. Schneider Electric products and equipment should be installed, operated, serviced, and maintained only by qualified personnel.

As standards, specifications, and designs change from time to time, information contained in this guide may be subject to change without notice.

To the extent permitted by applicable law, no responsibility or liability is assumed by Schneider Electric and its subsidiaries for any errors or omissions in the informational content of this material or consequences arising out of or resulting from the use of the information contained herein.

Table of Contents

Safety Precautions.....	5
UPS Shipping Weights and Dimensions	6
Receiving	7
Remove the UPS from the Pallet.....	8

Safety Precautions

⚠ WARNING

HAZARD OF ELECTRIC SHOCK, EXPLOSION, OR ARC FLASH

- Do not unpack the units before the time of installation.
- Cover the units and store the units in a temperature controlled indoor environment free of conductive contaminants and humidity, where the units are protected from moisture until the time of start-up. Moisture inside the cabinet can create hazardous short circuits.

Failure to follow these instructions can result in death, serious injury, or equipment damage.

NOTICE

RISK OF EQUIPMENT DAMAGE

- Wait until the system is ready to be powered up before installing batteries in the system. The time duration from battery installation until the UPS system is powered up must not exceed 72 hours or 3 days.
- Batteries must not be stored more than six months due to the requirement of recharging. If the UPS system remains de-energized for a long period, Schneider Electric recommends that you energize the UPS system for a period of 24 hours at least once every month. This charges the batteries, thus avoiding irreversible damage.

Failure to follow these instructions can result in equipment damage.

UPS Shipping Weights and Dimensions

UPS rating	Weight kg	Height mm	Width mm	Depth mm
500 kVA	690	2100	1200	1015
600 kVA	770	2100	1200	1015

Receiving

External Inspection

When the shipment arrives, inspect the shipping material for any signs of damage or mishandling. Do not attempt to install the system if a damage is apparent. If any damage is noted, contact Schneider Electric and file a damage claim with the shipping agency within 24 hours.

Compare the components of the shipment with the bill of lading. Report any missing items to the carrier and to Schneider Electric immediately.

Verify that labelled units match the order confirmation.

Remove the UPS from the Pallet

1. Move the UPS to the final installation area using a forklift.
2. Remove the shipping materials from the UPS.

NOTE: When removing the top packaging, save the kick plates (A) for later use during the installation.

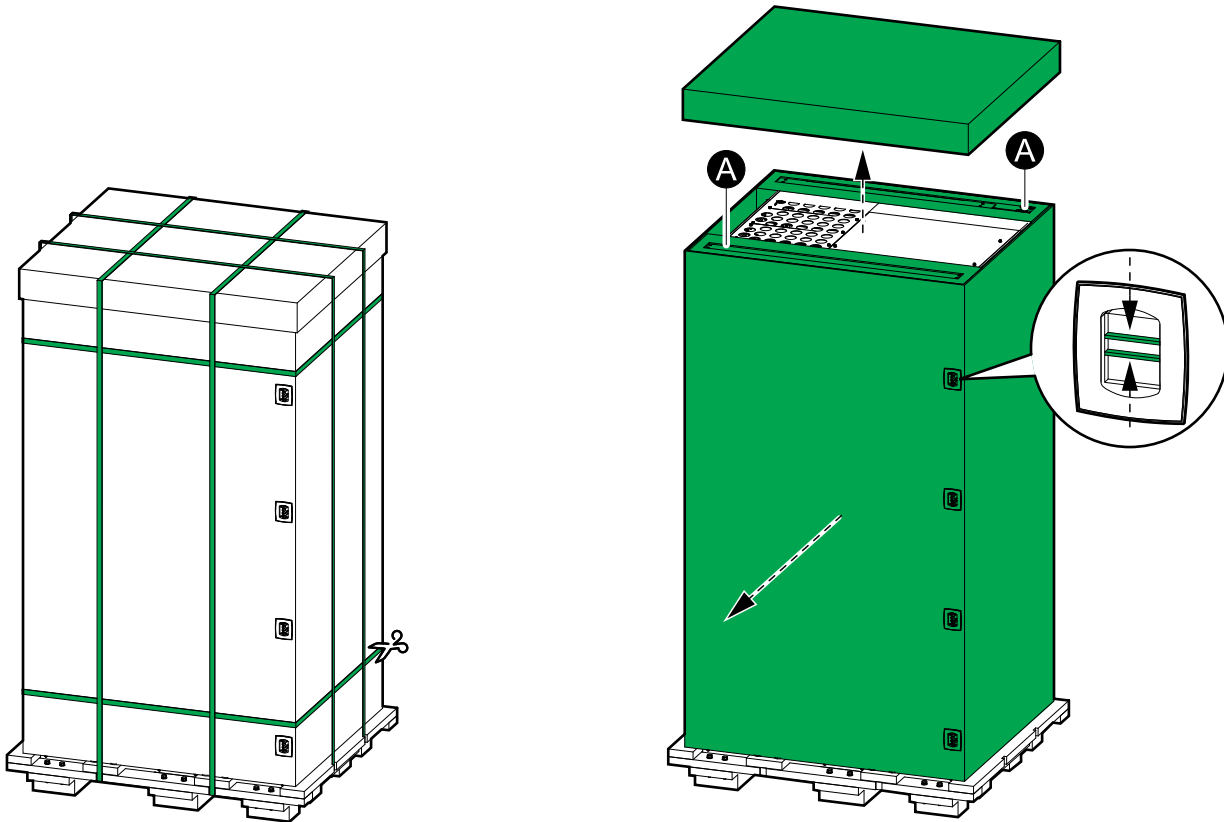

3. Loosen the bolts and remove the indicated pallet parts from the sides.

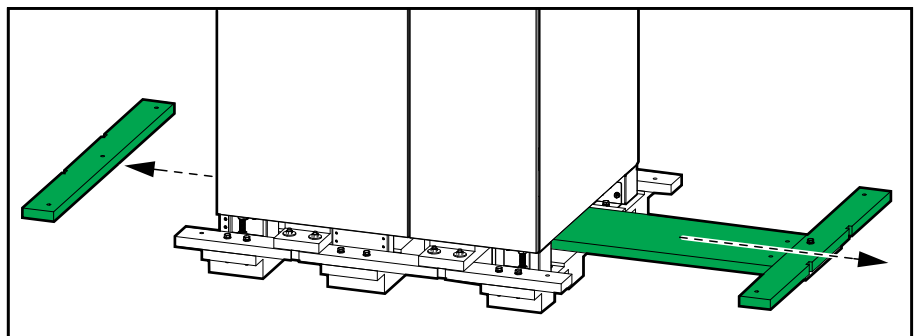

4. Loosen the bolts and remove the indicated pallet parts from the rear and front.

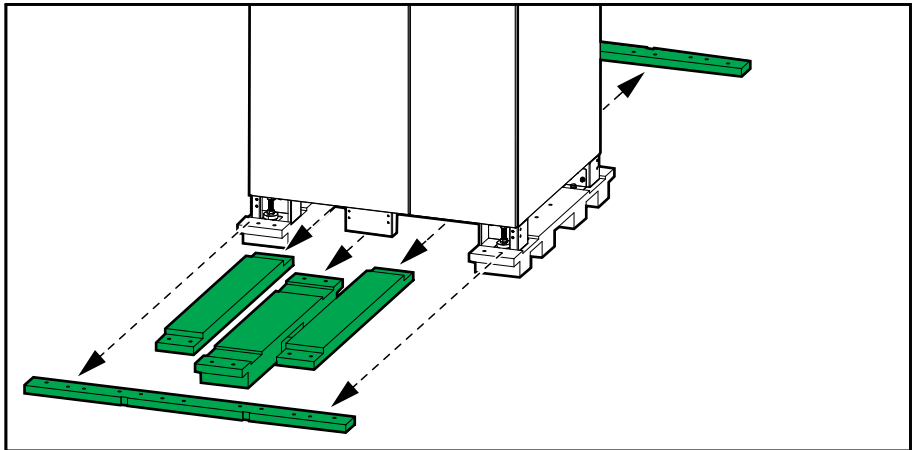

5. Remove the four metal brackets.

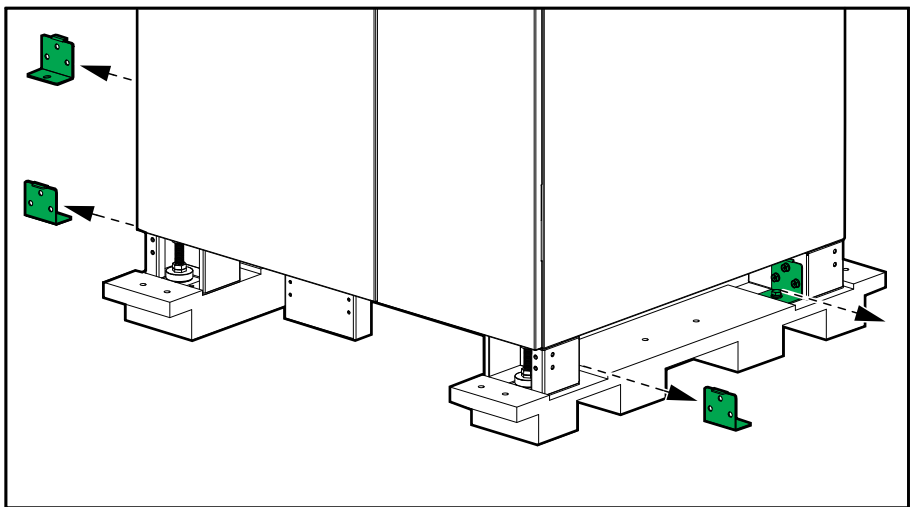

6. Use a forklift to lift the UPS and remove the remaining pallet parts.

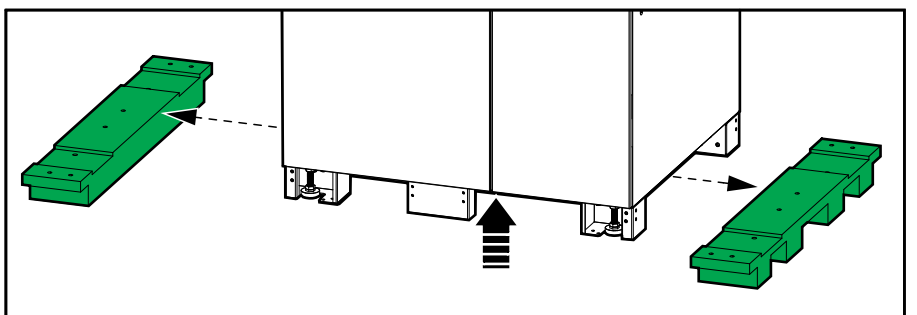

7. Move the UPS to its final location and use a wrench to lower the four leveling feet until they connect with the floor. Use a bubble-leveler to check that the UPS is level.

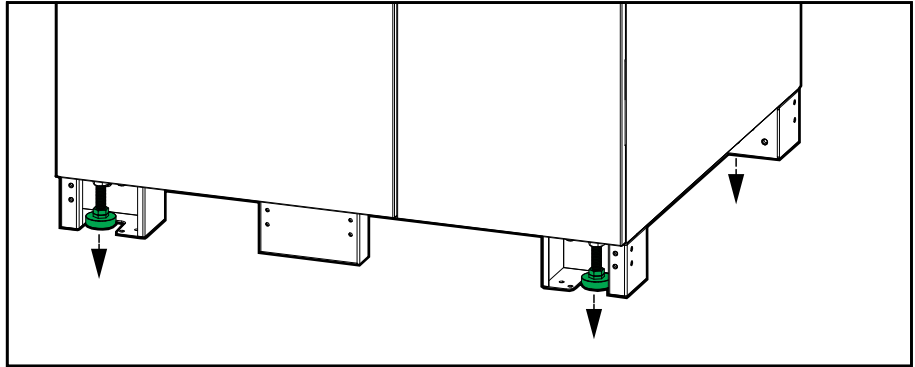

⚠ CAUTION

EQUIPMENT DAMAGE

Do not move the cabinet after the leveling feet have been lowered.

Failure to follow these instructions can result in injury or equipment damage.

Schneider Electric
35 rue Joseph Monier
92500 Rueil Malmaison
France

+ 33 (0) 1 41 29 70 00



As standards, specifications, and design change from time to time,
please ask for confirmation of the information given in this publication.

© 2020 – 2020 Schneider Electric. All rights reserved.

990-6288-001