

Prisma P

07733

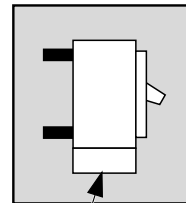

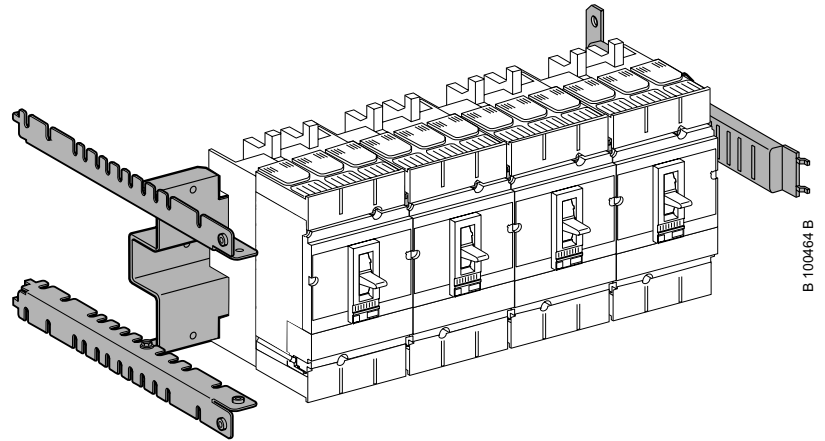
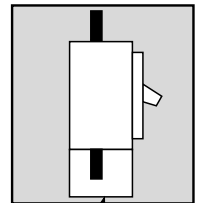

3P29321
4P29322

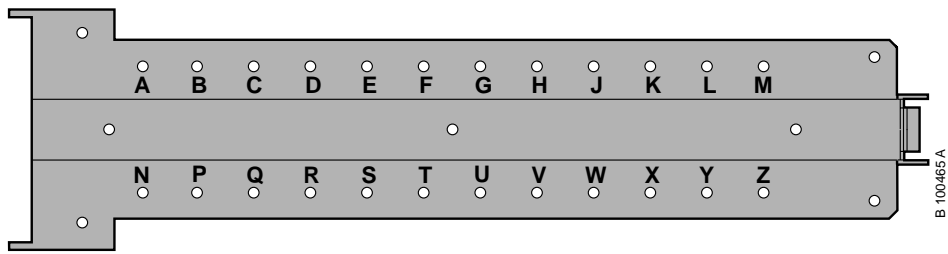

3P29323
4P29324

- Merlin Gerin
- Modicon
- Square D
- Telemecanique

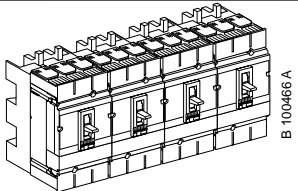
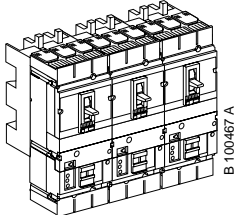
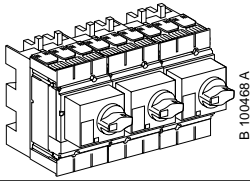
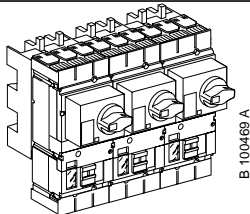
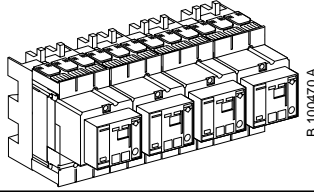
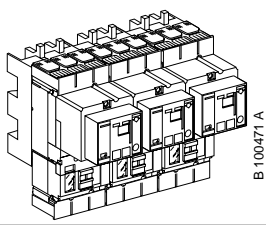
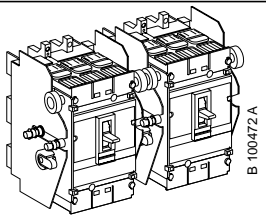
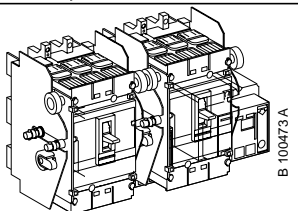

		
NS 100/160/250  <small>B 100466 A</small>	CN FR JU MX	ADNR EHSV JMZW
Vigi NS 100/160/250  <small>B 100467 A</small>	DP HT MX	ADNR EHSV JMZW
NS 100/160/250  <small>B 100468 A</small>	DP HT MX	ADNR EHSV JMZW
Vigi NS 100/160/250  <small>B 100469 A</small>	DP HT MX	ADNR EHSV JMZW
NS 100/160/250  <small>B 100470 A</small>	CN FR JU MX	ADNR EHSV JMZW
Vigi NS 100/160/250  <small>B 100471 A</small>	DP HT M X	ADNR EHSV JMZW
NS 100/160  <small>B 100472 A</small>	EQ + LW	EHSV
NS 100/160  <small>B 100473 A</small>	EQ + LW	EHSV

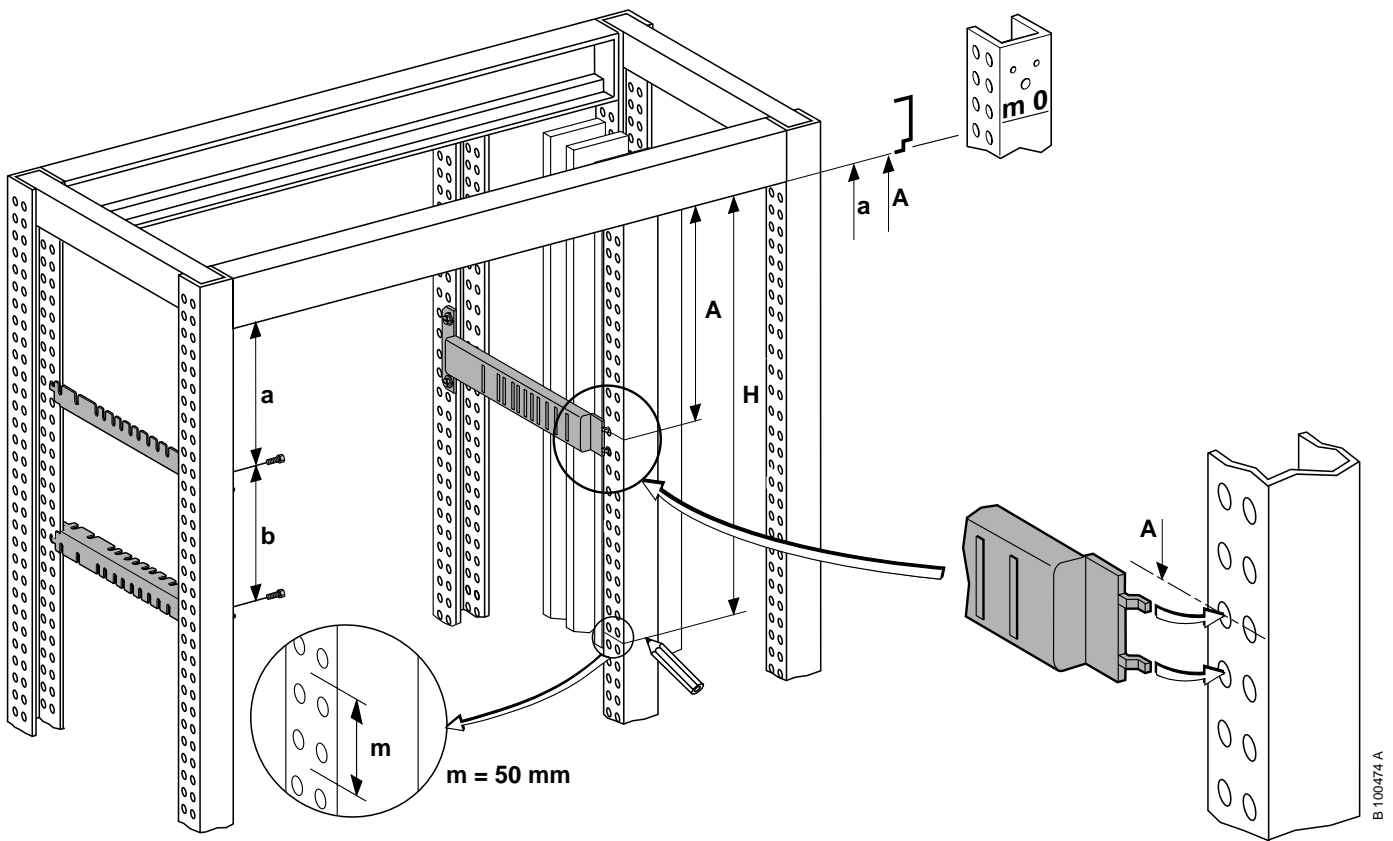

				m	H mm	A mm	a mm	b mm
NS 100/160		B 100475 A	6	300	112,5	37,5	175	
Vigi NS 100/160		B 100476 A	8	400	112,5	37,5	175	
NS 250		B 100475 A	9	450	212,5	137,5	175	
Vigi NS 250		B 100476 A	11	550	212,5	137,5	175	
NS 100/160		B 100477 A	7	350	162,5	87,5	175	
NS 250		B 100477 A	9	450	212,5	137,5	175	

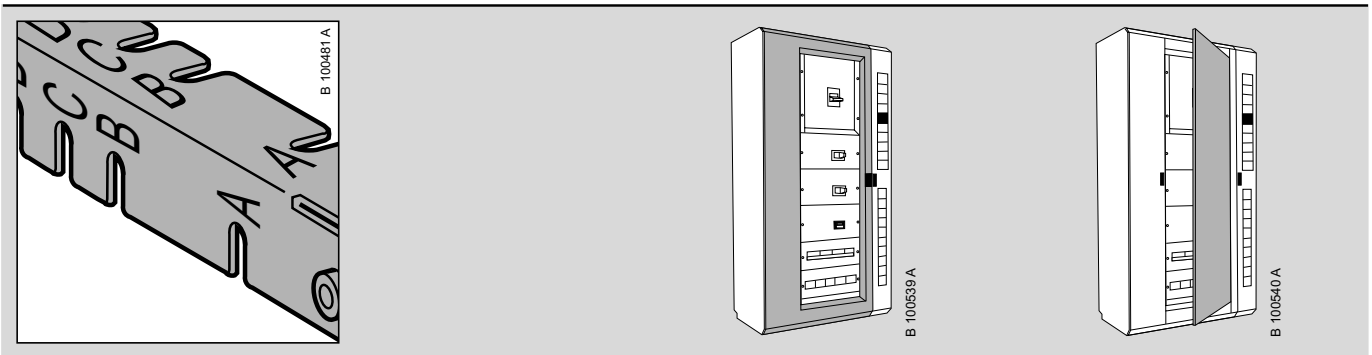
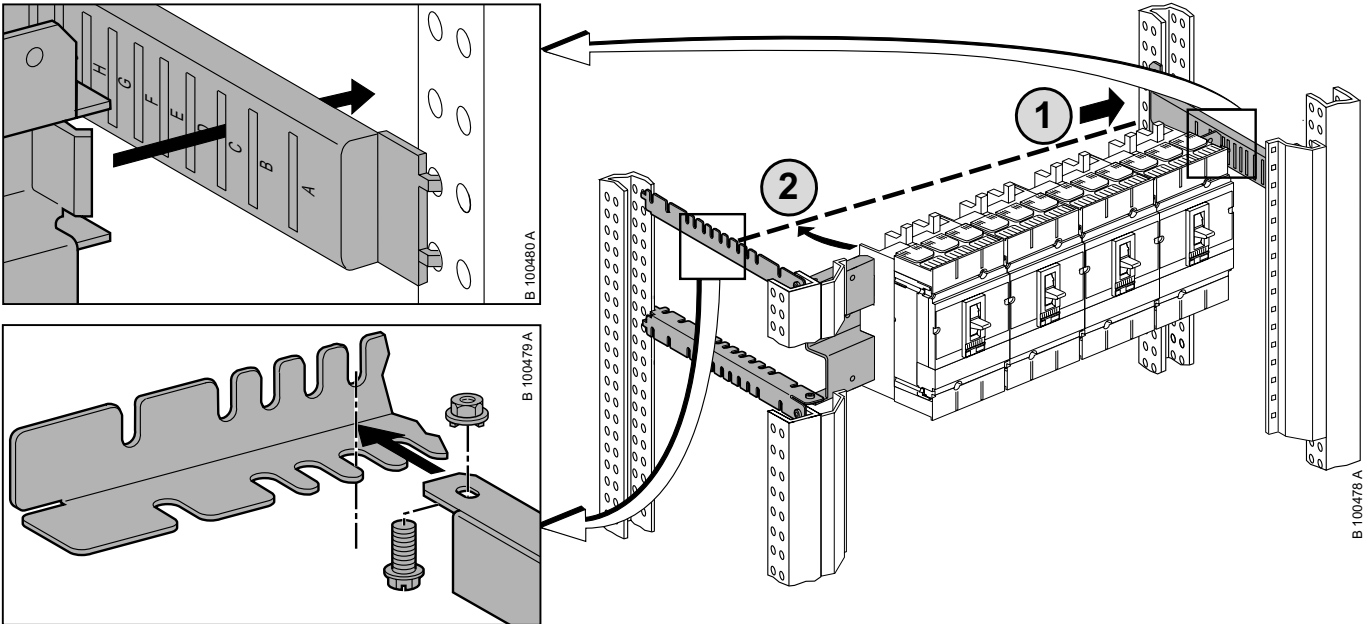

NS 100/160/250
Vigi NS 100/160/250

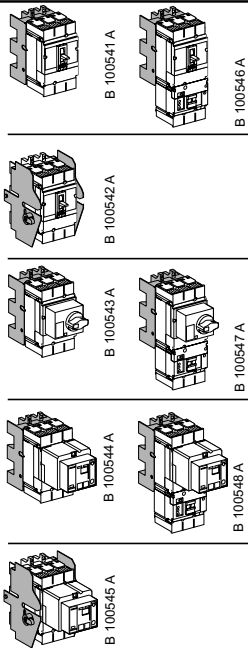

C

F

E

H

E

H

G

J

I

K

Schneider Electric Industries SA

Adresse postale
F-38050 Grenoble cedex 9
tél. 04 76 57 60 60
télex : merge 320 842 F

En raison de l'évolution des normes et du matériel, les caractéristiques indiquées par le texte et les images de ce document ne nous engageant qu'après confirmation par nos services techniques.

As standards, specifications and designs change please ask for confirmation of the information given in this publication.



ce document a été imprimé sur du papier écologique

format de pliage : 105 x 297 mm

Publication : Schneider Electric
Création : AMEG
Impression : VITTON COPIE