

Operator's Manual

ASCO® 5200 SERIES POWER MANAGER Xp

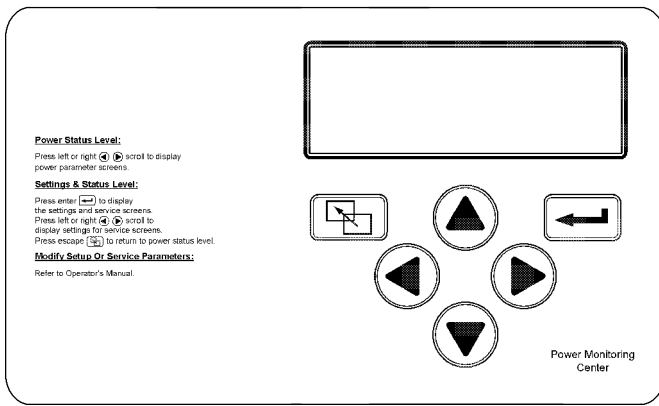

Catalog 5220D Power Manager Display, front view – typical enclosure door mounting.

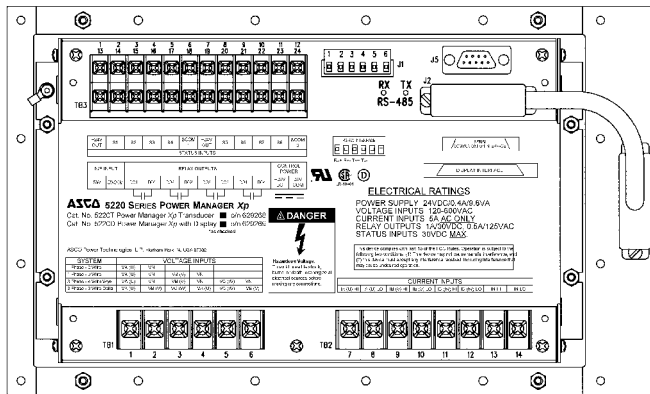

Rear view – Catalog 5220D Power Manager Transducer attached to the back of the Display.

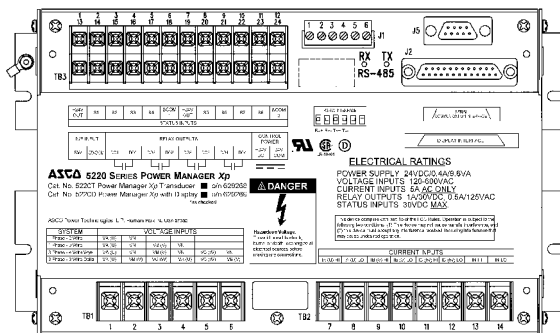

Catalog 5220T Power Manager Transducer only (without the Display).

Note: The 5200 Series Power Manager Xp is provided with a 7000 Series 7ASLS or 7ASLB usually without the display. Refer to the drawings provided with the switch.

TABLE OF CONTENTS

section-page

INTRODUCTION

General Information	1-1
Measurements & Specifications	1-3 & 1-4
Device Ratings	1-5

INSTALLATION

Mounting	2-1
Connections	2-2 & 2-3
Control Overview	2-4
Outline Mounting Drawing	627122
Wiring Diagram	629455

INITIAL SETUP

Password Selection	3-1
System Type, Source, & Language .	3-2 & 3-3
Frequency, Voltage, & Current Settings . . .	3-4
PT & CT Ratios	3-5
Serial Communication Interfaces . .	3-6 to 3-9
Reset Energy Level & Reset Event Log . .	3-10
Reset Maximum Demand Level	3-12
Watt Demand Window Size	3-13
Setpoint Configuration	3-14
Device 86 Configuration	3-15
KW Setpoints & Reset Time Delay	3-16 & 3-17
Date & Time Setting	3-18
Event Log	3-19
Setup Log & Reset	3-20 & 3-21
Engine Run Time Counter & Reset	3-22

OPERATING THE POWER MANAGER

Operation	4-1 & 4-2
-----------------	-----------

INDEX	back page
-------------	-----------

⚠ DANGER

To avoid possible shock, burns, or death, deenergize all electrical sources before making any connections to the Power Manager.

⚠ CAUTION

The protection provided by the equipment may be impaired if the Power Manager is used in a manner not specified by ASCO Power Technologies.

General Information

The ASCO 5200 Series *Power Manager Xp* collects real-time power system information from ASCO Power Control Systems and 7000 Series Automatic Transfer Switch products (which utilize the Group 5 Controller). The Power Manager is available in two forms: Catalog 5220D (Accessory 85 on an ATS) Power Manager (Display and Transducer) for local data monitoring and control; or Catalog 5220T (Accessory 75 on an ATS) Power Manager Transducer without the display transmits data serially to a remote network management product for collection and analysis.

The *Power Manager Xp* includes a backlit 4-line LCD display and membrane controls. All monitoring and control functions can be done from the front of an enclosure for convenience and safety.

The universal potential transformer inputs on the Power Manager can accommodate the following three phase and single phase bus types:

- Three phase – 4 wire WYE system
- Three phase – 3 wire Delta system
- Single phase – 3 wire system
- Single phase – 2 wire system

Monitored & Calculated Data

Set-up parameters as well as the following computed parameters are available both on the local display and through the serial interface:

- Line-to-neutral voltages (V_{AN} , V_{BN} , V_{CN})
- Line-to-neutral voltage average (V_{AVE})
- Line-to-line voltages (V_{AB} , V_{BC} , V_{CA})
- Line-to-line voltage average (V_{LAVE})
- Current on each phase (I_A , I_B , I_C)
- Current in the neutral conductor (I_N)
- Average current (I_{AVE})
- Active power, KW per phase and total (W_A , W_B , W_C , W_T)
- Reactive power, KVAR per phase and total (VAR_A , VAR_B , VAR_C , VAR_T)
- Apparent power, KVA per phase and total (VA_A , VA_B , VA_C , VA_T)
- Watt demand and maximum Watt demand
- KWHours importing, exporting and net (KWH_{IMP} , KWH_{EXP} , KWH_{NET})
- KVARHours leading, lagging and net ($KVARH_{LEAD}$, $KVARH_{LAG}$, $KVARH_{NET}$)
- KVAHours net ($KVAH_{NET}$)
- Power factor (PF)
- Signal frequency (Hz)
- Twelve configurable setpoints for Protective Relaying

Sense Inputs

- 4 current inputs
- 3 voltage inputs
- frequency input

Control Inputs & Outputs

- transfer switch position input
- 8 status inputs
- 4 relay outputs

Cleaning

The exterior of the 5200 Series *Power Manager Xp* should be cleaned by wiping the front panel of the display unit with a soft cloth and cleaning agents that are not alcohol based, and are nonflammable, nonexplosive. All other servicing should be performed by authorized factory personnel.

Measurement Conventions

The following diagrams show how the 5200 Series *Power Manager Xp* interprets and displays signed (+, -) values for power, power factor and energy parameters. Please note that the polarity of the Watts, VARs, Power Factor, energy import/export, and lag/lead readings can be reversed by reversing the polarity of the CTs connected to the Power Manager.

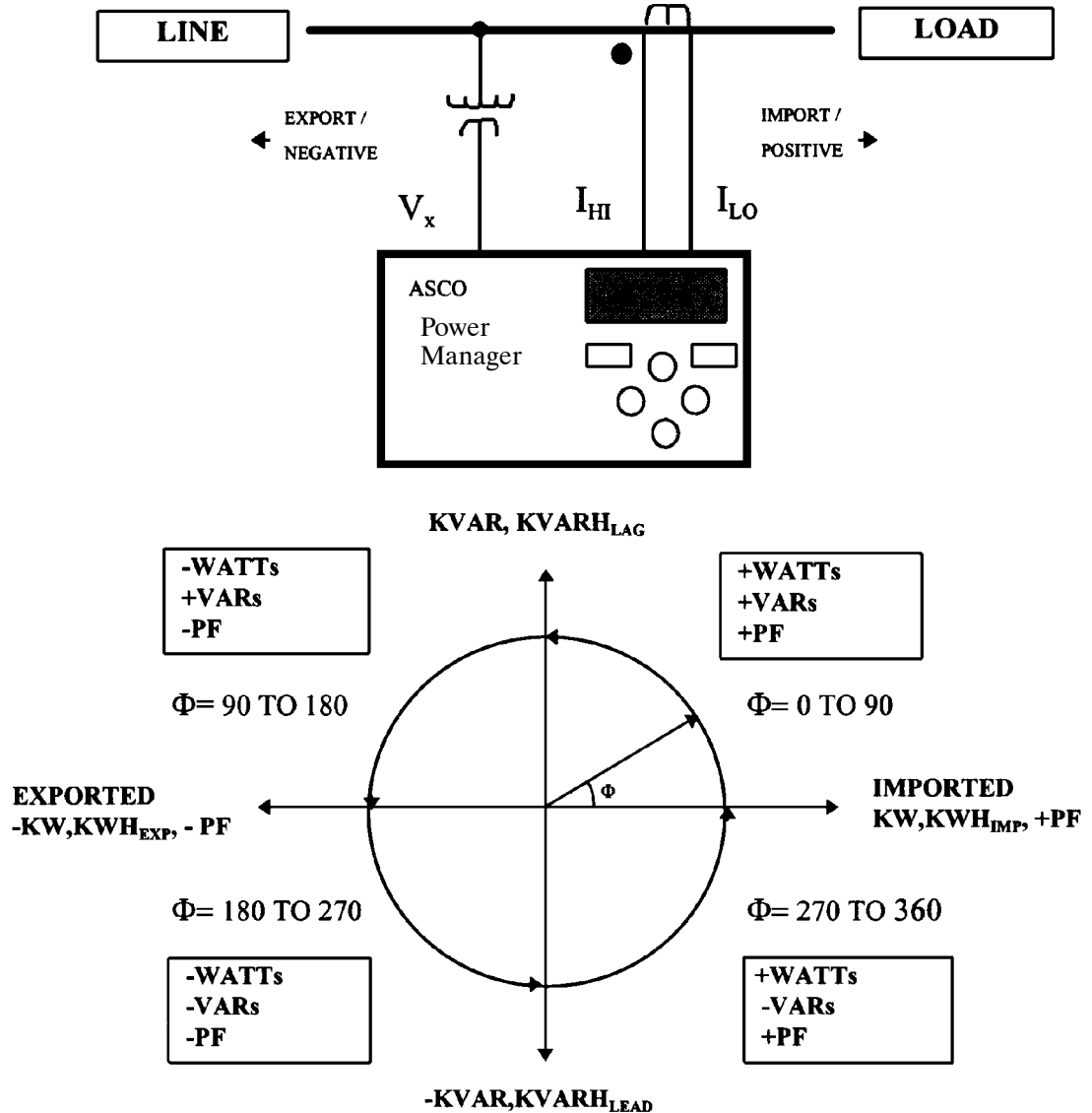

DEFINITIONS:

$$\Phi \equiv (\text{phase angle between voltage and current}) = \Phi_V - \Phi_I$$

$$\Phi_V \equiv \text{phase angle of voltage signal}$$

$$\Phi_I \equiv \text{phase angle of current signal}$$

LAGGING $\Phi \equiv (0 < \Phi < 90^\circ)$ for positive power flow. To illustrate this condition, assume $\Phi_V = 0$ and $(-90^\circ < \Phi_I < 0)$. This results in $(0 < \Phi < 90^\circ)$, so it would be stated that Φ_I LAGS Φ_V for positive power flow.

LEADING $\Phi \equiv (-90^\circ < \Phi < 0)$ for positive power flow. To illustrate this condition, assume $\Phi_V = 0$ and $(0 < \Phi_I < 90^\circ)$. This results in $(-90^\circ < \Phi < 0)$, so it would be stated that Φ_I LEADS Φ_V for positive power flow.

Measurement Specifications

NOTE: The accuracy specifications are subject to change.
Contact ASCO Power Technologies for more information.

- Temperature : 25°C / 77°F
- Frequency : 50.0 Hz or 60.0 Hz
- Current input : 2 % < I_{FULL SCALE} < 125 %
- Sensing type: True RMS up to and including the 21st harmonic.

Parameter (full scale)		Accuracy (% full scale)	Display	
			Resolution	Range
Current (I)	5.000 A	0.25 %	0.25 %	0 – 29 999 ¹
Voltage (V)	120 V	1.00 %	1.00 %	0 – 59 999 ²
	600 V	0.25 %	0.25 %	0 – 59 999 ²
Active Power (KW) (per element)	600 W	1.00 %	0.25 %	0 – 29 999 ³
	3000 W	0.25 %	0.10 %	0 – 29 999 ³
Reactive Power (KVAR) (per element)	600 VAR	1.00 %	0.25 %	0 – 29 999 ³
	3000 VAR	0.25 %	0.10 %	0 – 29 999 ³
Apparent Power (KVA) (per element)	600 VA	1.00 %	0.25 %	0 – 29 999 ³
	3000 VA	0.25 %	0.10 %	0 – 29 999 ³
Active Energy (KWH)		1.00 % of reading	0.10 %	– 1 999 999 999 to + 1 999 999 999
Reactive Energy (KVARH)		1.00 % of reading	0.10 %	– 1 999 999 999 to + 1 999 999 999
Apparent Energy (KVAH)		1.00 % of reading	0.10 %	0 – 1 999 999 999
Power Factor (PF)		1.00 %	0.01 PF	–0.0 to 1.00 to +0,0
Frequency (Hz)		0.25 %	0.1 Hz	40 to 100 Hz

NOTES:

¹ Reads in KA (i.e., 10.00 KA) for currents over 9,999 A.

² Reads in KV (i.e., 10.0 KV) for voltages over 9,999 V.

³ Reads in MW, MVAR, MVA for readings over 9,999 K.

FCC Class A Statement

This equipment has been tested and found to comply with the limits for a Class A digital device, pursuant to part 15 of the FCC Rules. These limits are designed to provide reasonable protection against harmful interference when the equipment is operated in a commercial environment. This equipment generates, uses, and can radiate radio frequency energy and, if not installed and used in accordance with the instruction manual, may cause harmful interference to radio communications. Operation of this equipment in a residential area is likely to cause harmful interference in which case the user will be required to correct the interference at his own expense.

Device Ratings

Input Signals

- Current (4): 0 to 5 A ac nominal. 4000 V ac isolation, minimum.
Burden: less than 2mV at 5 A ac input (0.01 VA)
- Voltage (3): 0 to 600 V ac nominal, three phase. 3750 V ac isolation minimum.
Burden: less than 0.1 mA ac at 600 V ac input (0.1 VA).
- Frequency: 40 Hz to 100 Hz fundamental.
True RMS measurements up to and including the 21st harmonic.

Relay outputs (4): Form C dry contact,
UL/CSA rated 1 A @ 30 V dc, 0.5 A @ 125 V ac resistive load

Status inputs (8): 30 V dc maximum, >10 V dc = active, <1 V dc = inactive
status input burden = 12 mA @ 24 V dc

Transfer Switch

Position input: 30 V dc maximum, >10 V dc = active, <1 V dc = inactive

Power Requirements: 24 V dc / 0.3 A maximum / 7.2 VA
Power supply should be UL Listed.

CAUTION Risk of explosion if battery is replaced by an incorrect type.
Dispose of used batteries according to local ordinances.

Interface (s): External display (J2) – Class 1 DB25 female type
SCI (J5) – Class 2 DB9 female type
RS485 (J1) – Isolated RS485 Communications interface

Operating Temp.: –4° F to +140° F (–20° C to +60° C)

Storage Temp.: –67° F to +185° F (–55° C to +85° C)

Installation Category: IC III

Pollution Degree: PD 2

Humidity: Relative humidity 5% to 95%, non–condensing.

Size:

Catalog 5220T 6” H x 2 ¾” D x 10” W (152 mm H x 70 mm D x 254 mm W)
Catalog 5220D 7” H x 5” D x 12” W (178 mm H x 127 mm D x 304 mm W)
(includes Power Manager Display)

Weight:

Catalog 5220T 3 lbs. 5 oz (1.50 kg)
Catalog 5220D 5 lbs. 11 oz (2.58 kg)
(includes Power Manager Display)

Applicable Standards

UL 3111–1 Electrical Measuring and Test Equipment, Part 1: General Requirements

CAN/CSA–C22.2 No. 231–M89 CSA Safety Requirements for Electrical and Electronic Measuring and Test Equipment

Mounting

The 5200 Series Power Manager Xp must be mounted to a flat surface inside a metal enclosure. For Catalog 5220T (Acc. 75) mount the Power Manager Xp Transducer by using the four slotted mounting locations in the base.

For Catalog 5220D (Acc. 85) mount the Display (Transducer with Display) to the inside of an enclosure door which has a 10" x 6" cutout so that the LCD display and membrane controls are accessible through the door (when closed).

Use a standard nutdriver to mount the Power Manager Xp.
Tighten all mounting hardware to 10 in-lb maximum.

See Outline & Mounting Drawing 627122 (next two pages)

DATA MONITOR or POWER MANAGER/POWER MANAGER XP
 MONITOR MOUNTING DATA (TYPE 1 ENCLOSURE INSTALLATIONS)
 (USING THROUGH HOLE MOUNTING METHOD)

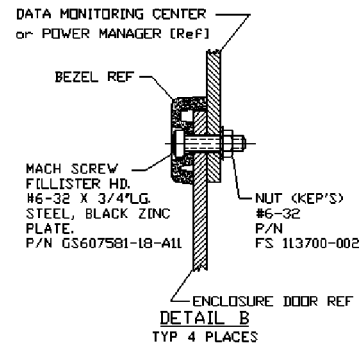
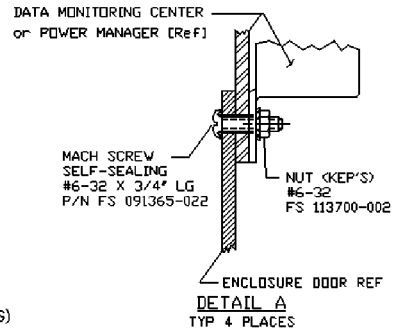
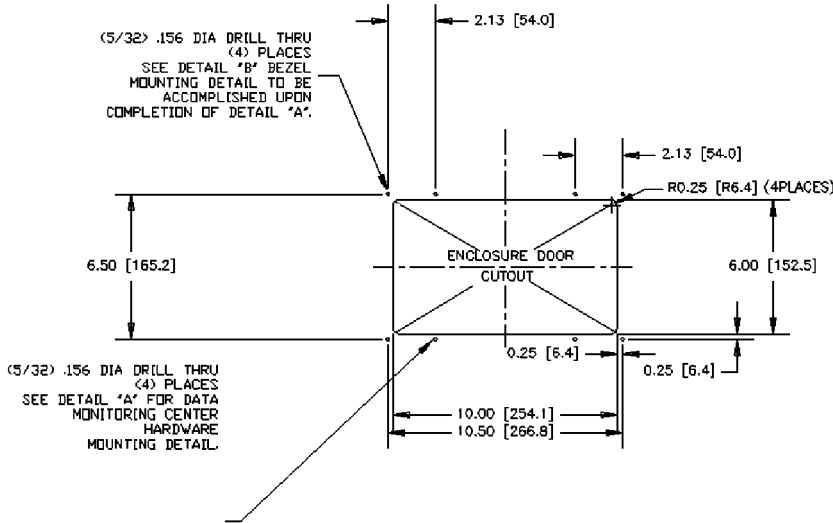

DATA MONITOR or POWER MANAGER/POWER MANAGER XP
 MOUNTING DATA (TYPE 3R, 4 & 12 ENCLOSURE INSTALLATIONS)
 (USING THROUGH HOLE MOUNTING METHOD)

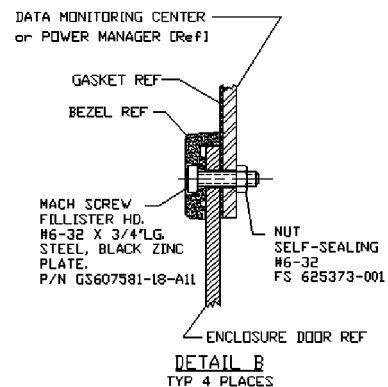
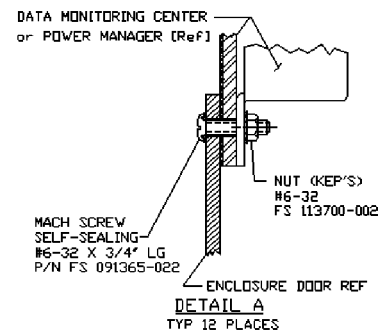
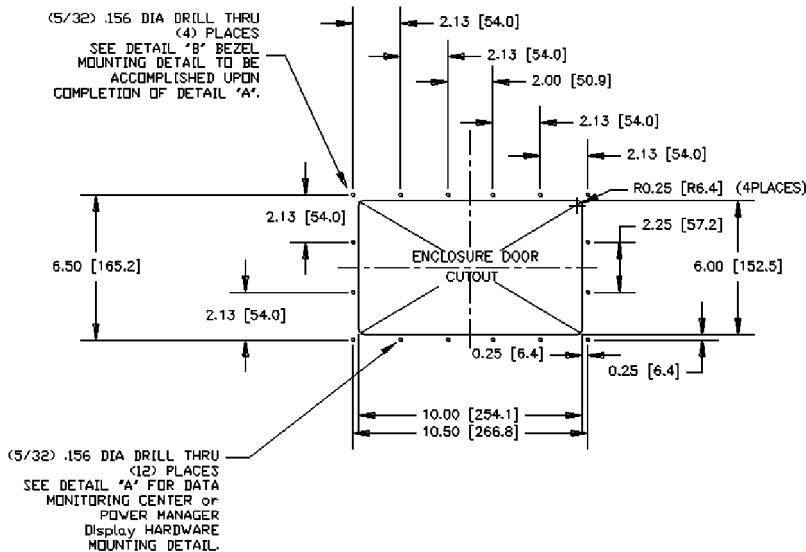

**DATA MONITOR or POWER MANAGER/POWER MANAGER XP
MOUNTING DATA (TYPE 1, 3R, 4 & 12 ENCLOSURE INSTALLATIONS)
(USING SELF-CLINCHING CAPTIVE STUD MOUNTING METHOD)**

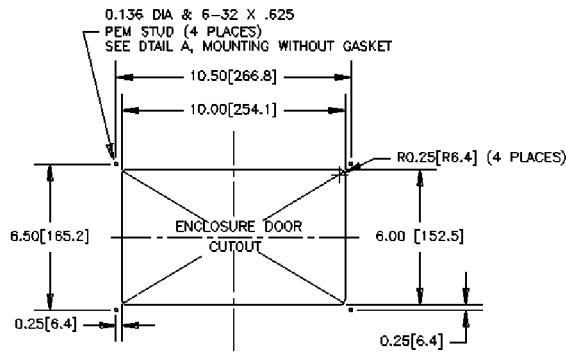

CUTOUT DETAIL FOR TYPE 1 ENCLOSURE (USE PEM STUD)

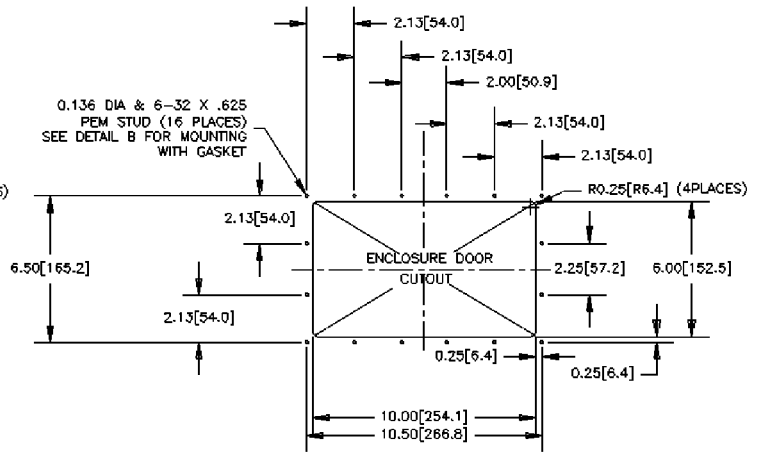

CUTOUT DETAIL FOR TYPE 3R, 12 & 4 ENCLOSURE (USE PEM STUD)

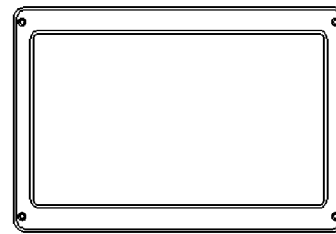
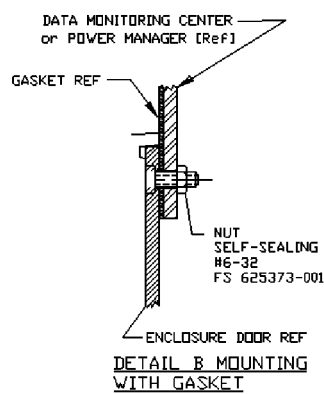
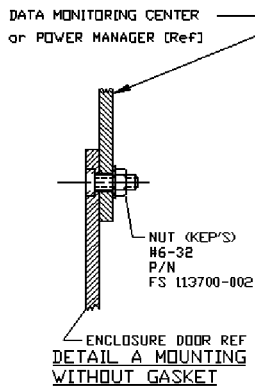

BEZEL PN.607574

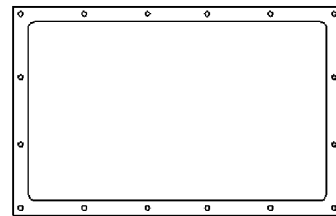

GASKET PN.605537

**DATA MONITOR WITHOUT DISPLAY or
POWER MANAGER TRANSDUCER/POWER MANAGER XP TRANSDUCER
[WITHOUT DISPLAY]
MOUNTING DATA**

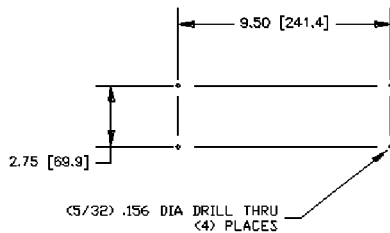

NOTE:

1. BEZEL IS REQUIRED FOR TYPE 1 ENCLOSURE WHEN USING DRILL THROUGH MOUNTING METHOD.
2. BEZEL AND GASKET ARE REQUIRED FOR TYPE 1, 3R & 4 ENCLOSURE WHEN USING DRILL THROUGH MOUNTING METHOD
3. GASKET IS REQUIRED FOR TYPE 3R, 12 & 4 ENCLOSURE WHEN USING PEM STUD MOUNTING METHOD.

ALL DIMENSIONS: INCH[mm]

PROJECT NAME:		CHANGE LETTER	EDN NO.	BY	APP.	DATE
MOUNTING DATA		SUBSIDIARY DISTRIBUTION				
DATA MONITOR Cat. Nos. 214A700, 214A701		AK	AN	AM	AL	AL
POWER MANAGER Cat. Nos. 5200T, 5200D		CH	AV	AA	PS	AR
POWER MANAGER XP Cat. Nos. 5220T, 5220D		AG	AP	AC	AS	AS
TYPE 1, 3R 12 & 4		COMPUTER GENERATED DRAWING				
THIRD ANGLE PROJECTION	ASSEMB. REF. NO.	SCALE: 6:1		FILE 00		
BY YZ 12/86	MANUFACTURING TOLERANCES TO BE IN ACCORDANCE WITH ASQC PROCEDURE MP-41-003. FOR PLASTIC PARTS SEE MP-4-003.	SIZE: DWG. NO.		DS1627122		
CHECKED	PROPERTY OF AUTOMATIC SWITCH COMPANY. USE PERMITTED FOR OUR WORK ONLY. ALL RIGHTS OF DESIGN OR INVENTION ARE RESERVED.	DWG. NO.		155797		
DRAWING APPROVAL	Automatic Switch Co.	DWG. NO.		155797		
DRAW APPROVAL	FLORHAM PARK, NEW JERSEY 07932 PRINTED IN U.S.A.	DWG. NO.		155797		
SDH 12/86		DWG. NO.		155797		
		DWG. NO.		155797		

Connections

See Wiring Diagram 629455 (following page 2-3).

Make the appropriate connections as shown on the label on the *Power Manager Xp* Transducer and on the wiring diagrams.

CAUTION

To prevent damaging the Power Manager deenergize (turn off) all power to the unit before you connect or disconnect the shielded interconnecting cable and all other wiring to the terminal blocks.

Tightening Torque

Tighten all connection terminals to 10 in-lb maximum.

Interconnecting Cable

If a *Power Manager Xp* Display is provided be sure that its shielded cable is connected to socket J2 on *Power Manager Xp* Transducer.

Power Supply Connections Class 1 circuit See CAUTION above!

Use a Class 1 power supply that is UL Listed. Connect the 0.3 amp. 24 volt dc power supply to terminal 23 (+) and terminal 24 (com) on terminal block TB3 marked *Control Power* on the *Power Manager Xp* Transducer. Refer to the labeling below terminal block. Use 18 AWG stranded copper wire.

DANGER

To avoid possible shock, burns, or death, deenergize all electrical sources before making any connections to the *Power Manager Xp*.

Lethal voltages can result if current transformers are open circuited while carrying primary current. To avoid injury turn off primary circuit or short out CT secondary circuit.

CT Connections

Connect the current transformers (CTs) with 5 amp. rated secondaries to the appropriate terminals 7-14 marked *Current Inputs* on the *Power Manager Xp* Transducer. Refer to the labeling above terminal block TB2. Note the shorting block connections on the Wiring Diagram. See **DANGER** above!

Voltage Connections

Connect the system voltage (120 to 600 volts ac) to the appropriate terminals 1-6 marked *Voltage Inputs* on the *Power Manager Xp* Transducer. For system voltages above 600 volts ac use appropriate potential transformers (PTs). Refer to the labeling above terminal block TB1. Note the fusing requirements (1 amp. / 600 V) on the Wiring Diagram. See **DANGER** above!

Transfer Switch Position

If an automatic transfer switch is used, connect an unused auxiliary contact (Feature 14A) on the transfer switch to the appropriate terminals marked *N/E Input* on the *Power Manager Xp* Transducer terminals 13 & 14. Refer to the labeling below terminal block TB3 (lower row). Refer to the ATS Operator's Manual and ATS wiring diagram for the location of Feature 14A contact. This connection to the Power Manager allows it to monitor and display the position of the transfer switch (page 4-1 step 1).

CAUTION

The transfer switch position indicating auxiliary contact (Feature 14A) **must** be connected to the Power Manager for proper operation. If not, select *Other* for Source to be monitored (page 3-2).

Status Voltage Input

Connect up to eight status voltage inputs to the appropriate terminals 1-12 marked *Status Inputs* on terminal block TB3 of the *Power Manager Xp* Transducer. Each input can operate either from an external 24 V dc signal or by using external contacts with the internally provided 24 V dc source. The Wiring Diagram shows suggested wiring methods for the Status Inputs. Refer to labeling below terminal block TB3 (upper row). These status inputs are independent of the four relay outputs listed below. The status of the inputs can be monitored on the display (see page 4-2 steps 15 & 16). The status of these inputs can be transmitted serially for remote display. The default display name of *Status Input 1*, or Input 2, etc. can also be changed serially to a unique 15 character name by using ASCO Power Technologies software.

Relay Output

Connect up to four circuits to the *Power Manager Xp*'s four normally-open relay outputs (each internal contact is rated 1 amp. at 30 volts dc, 0.5 amp. at 125 volts ac resistive load). Terminals 15-22 are marked *Relay Outputs* on the Power Manager Transducer. Refer to the labeling below terminal block TB3 (lower row). These outputs are independent of the Status Voltage Inputs described above. See page 4-2 step 17 for the display of the outputs. These outputs can then be transmitted serially for display, and remote operation. The default display name of *Relay Output 1*, or output 2, etc. can also be changed serially to a unique 15 character name by using ASCO Power Technologies software.

Ground Connection

The *Power Manager Xp* is provided with an earth ground screw and a UL Listed insulated ring terminal. The user should properly crimp the terminal lug to UL listed 16 gauge copper wire with 600 V insulation, color coded green with yellow stripes. Use an AMP crimp tool number 47387 or UL approved equivalent crimp tool.

When the Power Manager is mounted on a door, a conductive strap must be used between the enclosure and the door. This connection provides proper grounding which does not rely upon the door hinges.

Communication Network Connections RS-485 (J1) or SCI (J5) Class 2 circuit

See Wiring Diagram 629455 (following this page).

Notes

Catalog 5110 Serial Module and Catalog 5150 Connectivity Module use different cables than those specified here.

For Catalog 5110 Serial Module refer to Installation Manual 381333-240.

For Catalog 5150 Connectivity Module refer to Installation Manual 381333-238.

RS-485 (Port J1) – Use the RS-485 interface to connect the Power Manager directly to an RS-485 based communications network. Baud rates of up to 57.6K baud are supported on this interface.

SCI (Port J5) – Use the SCI interface to connect to an ASCO Accessory 72A Serial Communications Module which provides a gateway onto a RS-485 communications network. Refer to wiring diagram 629455 for connection details. Baud rates of up to 19.2K baud are supported on this SCI/72A interface.

First, use ASCO cable 489672 (8 inch) or 489672-001 (4 foot) to connect the unit's serial communications interface connector J5 to the Acc. 72A Serial Communication Module connector J1. Then, use only the recommended communication cable (see below) to connect the Acc. 72A Module to the RS-485 network. Connect the transmit and receive communication cable (twisted pairs) as shown on Wiring Diagram 629455.

Acceptable Communication Cable

Type of Cable	Acceptable Manufacturer's Numbers
Standard 80° C	Belden 9842, 9829, Alpha 6202C, 6222C
Plenum Rated	Belden 89729, 82729, Alpha 58902

2 Wire Single Phase Input Voltage < 600Vac(L-L), no external PTs

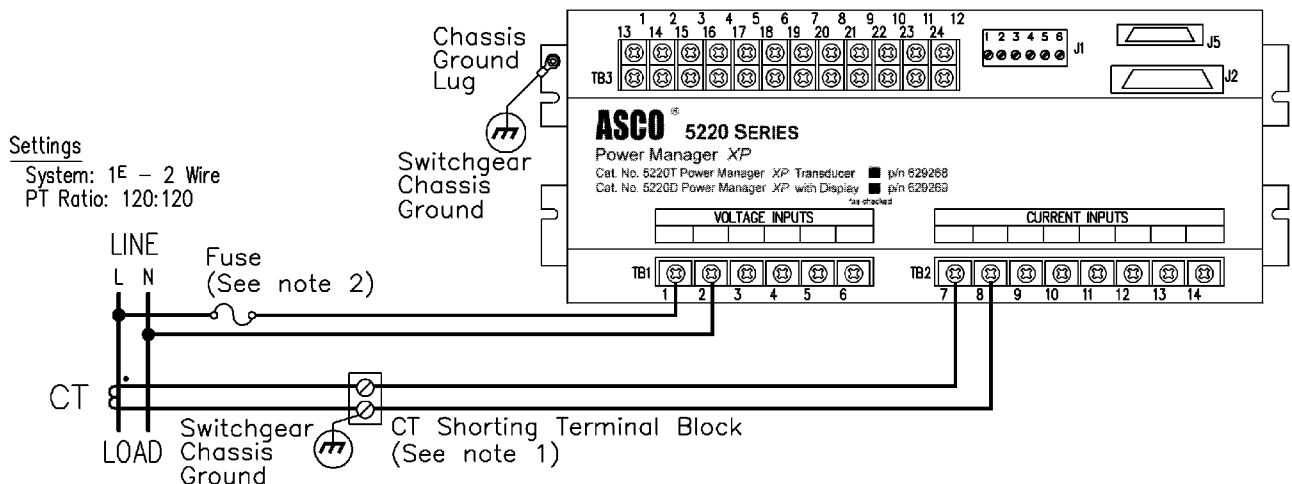

3 Wire Single Phase Input Voltage < 600Vac(L-L), no external PTs required

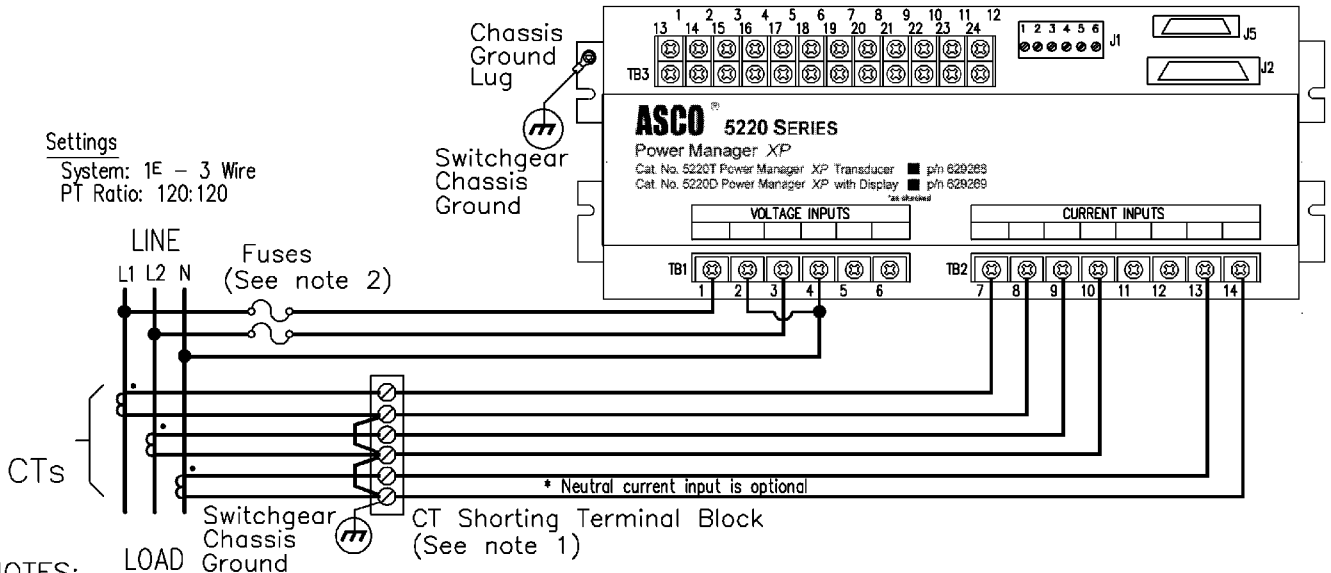

NOTES:

1. A shorting terminal block is recommended at the CT location.
2. Voltage inputs require 1Amp/600V fuses.

F	209529	SRC	JEH	7/06
Update XP Graphics				
E	202293	SRC	SC	11/01/04
Sht 2 Add Note 4				
D	158501	CH	WP	8/01
DEL SILK PWR MGR REF				

CHANGE LETTER	ECN NO.	BY	APP.	DATE
---------------	---------	----	------	------

SUBSIDIARY DISTRIBUTION										
AE	<input type="checkbox"/>	AN	<input type="checkbox"/>	AM	<input type="checkbox"/>	AJ	<input type="checkbox"/>	AL	<input type="checkbox"/>	<input type="checkbox"/>
CH	<input type="checkbox"/>	AV	<input type="checkbox"/>	AA	<input type="checkbox"/>	PS	<input type="checkbox"/>	AR	<input type="checkbox"/>	<input type="checkbox"/>
AG	<input type="checkbox"/>	AP	<input type="checkbox"/>	AC	<input type="checkbox"/>	AS	<input type="checkbox"/>	<input type="checkbox"/>	<input type="checkbox"/>	<input type="checkbox"/>

COMPUTER GENERATED DRAWING		
----------------------------	--	--

SCALE	None	ACAD	FILE	_01
-------	------	------	------	-----

SIZE	DWG. NO.	AS 629455	
------	----------	-----------	--

CHANGE LETTER	F	ECN NO.	209529	SHEET	1 OF 6
---------------	---	---------	--------	-------	--------

PROJECT NAME:

WIRING DIAGRAM

Power Manager Xp

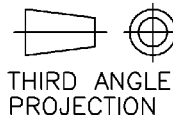

	BY	DATE
DRAWN BY	SC	12/00
CHECKED		
DRAFTING APPROVAL		
FINAL APPROVAL	RS	12/00

MANUFACTURING TOLERANCES TO BE IN ACCORDANCE WITH ASCO PROCEDURE MP-1-003. FOR PLASTIC PARTS SEE MP-1-055

PROPERTY OF ASCO POWER TECHNOLOGIES. USE PERMITTED FOR OUR WORK ONLY. ALL RIGHTS OF DESIGN OR INVENTION ARE RESERVED.



ASCO POWER TECHNOLOGIES, L.P.
FLORHAM PARK, NEW JERSEY 07932 U.S.A.

ASSEM. REF. NO.

3 Wire DELTA system Input Voltage < 600Vac(L-L), no external PTs

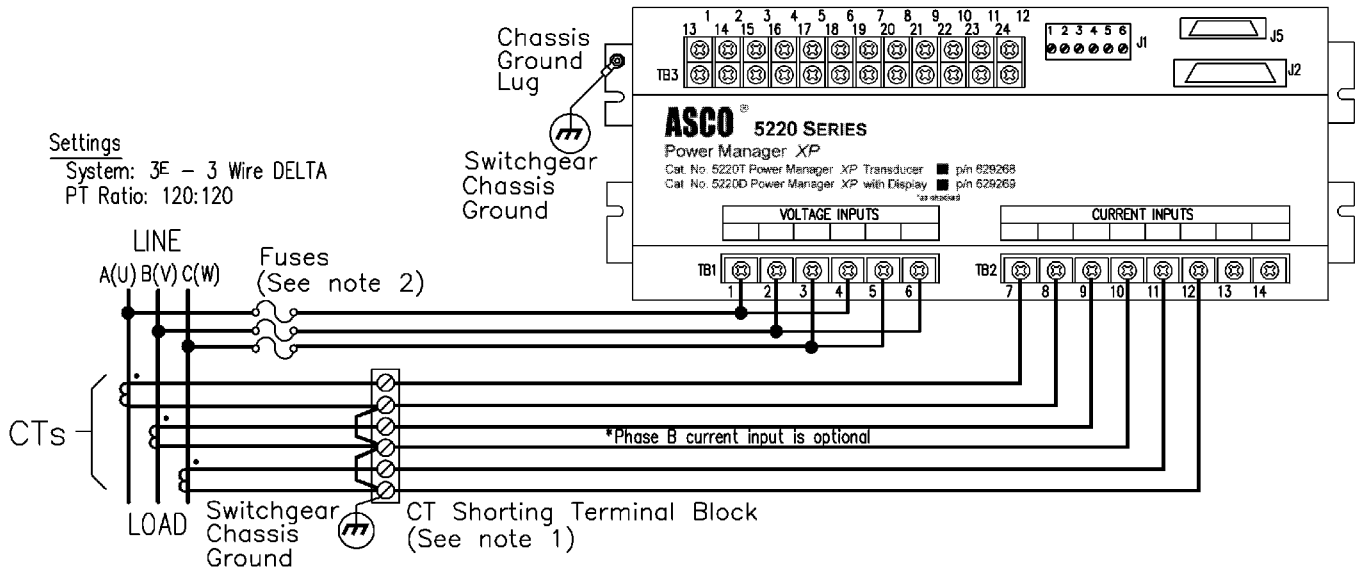

3 Wire DELTA system w/PTs Input Voltage > 600Vac(L-L), external PTs required

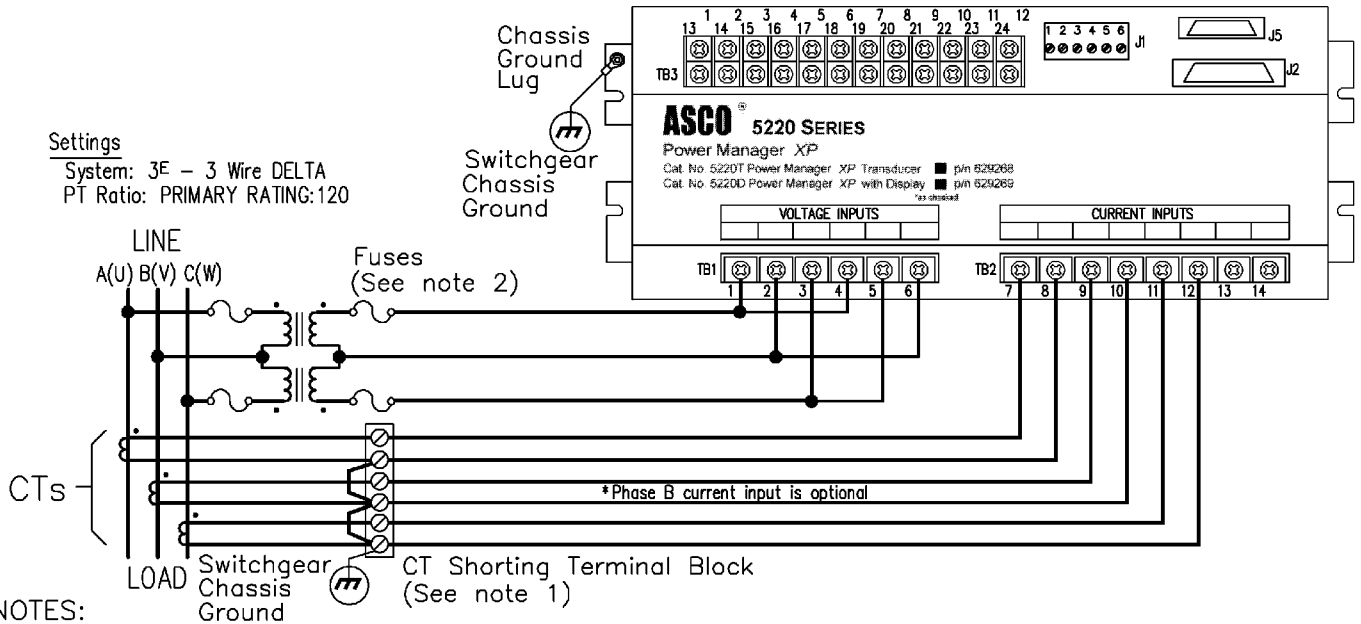

NOTES:

1. A shorting terminal block is recommended at the CT location.
2. Voltage inputs require 1Amp/600V fuses.
3. European convention for phase marking, UVW, shown in parenthesis next to A,B,C markings.
4. Use this wiring configuration for Balanced Loads ONLY.

PROJECT NAME:				CHANGE LETTER	ECN NO.	BY	APP.	DATE
WIRING DIAGRAM				SUBSIDIARY DISTRIBUTION				
Power Manager Xp				AE <input type="checkbox"/>	AN <input type="checkbox"/>	AM <input type="checkbox"/>	AJ <input type="checkbox"/>	AL <input type="checkbox"/>
				CH <input type="checkbox"/>	AV <input type="checkbox"/>	AA <input type="checkbox"/>	PS <input type="checkbox"/>	AR <input type="checkbox"/>
				AG <input type="checkbox"/>	AP <input type="checkbox"/>	AC <input type="checkbox"/>	AS <input type="checkbox"/>	<input type="checkbox"/>
MANUFACTURING TOLERANCES TO BE IN ACCORDANCE WITH ASCO PROCEDURE MP-1-003. FOR PLASTIC PARTS SEE MP-1-055				COMPUTER GENERATED DRAWING				
BY	DATE	PROPERTY OF ASCO POWER TECHNOLOGIES. USE PERMITTED FOR OUR WORK ONLY. ALL RIGHTS OF DESIGN OR INVENTION ARE RESERVED.		SCALE		ACAD		FILE
DRAWN BY	SC	12/00	ASSEM. REF. NO.	None				_02
CHECKED				SIZE	DWG. NO.			
DRAFTING APPROVAL				AS 629455				
FINAL APPROVAL	RS	12/00	ASCO® ASCO POWER TECHNOLOGIES, L.P. FLORHAM PARK, NEW JERSEY 07932 U.S.A.	CHANGE LETTER	ECN NO.	SHEET		
				F	209529	2 OF 6		

4 Wire WYE system

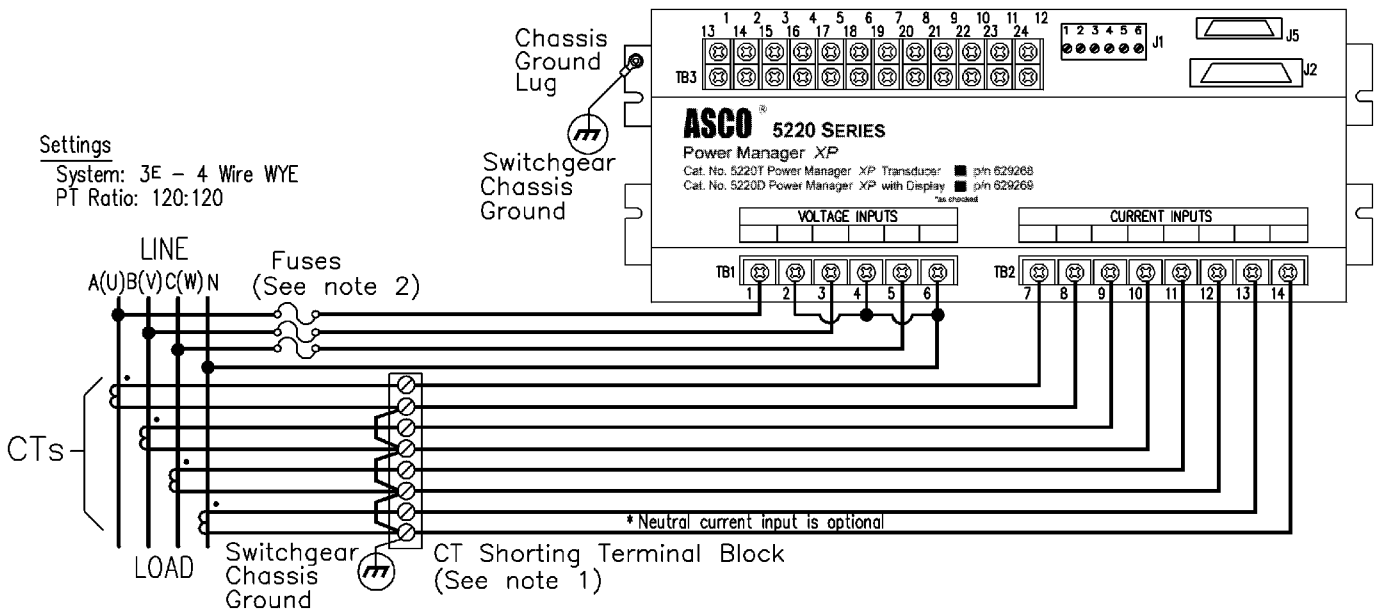

4 Wire WYE system w/PTs Input Voltage > 600Vac(L-L), external PTs required

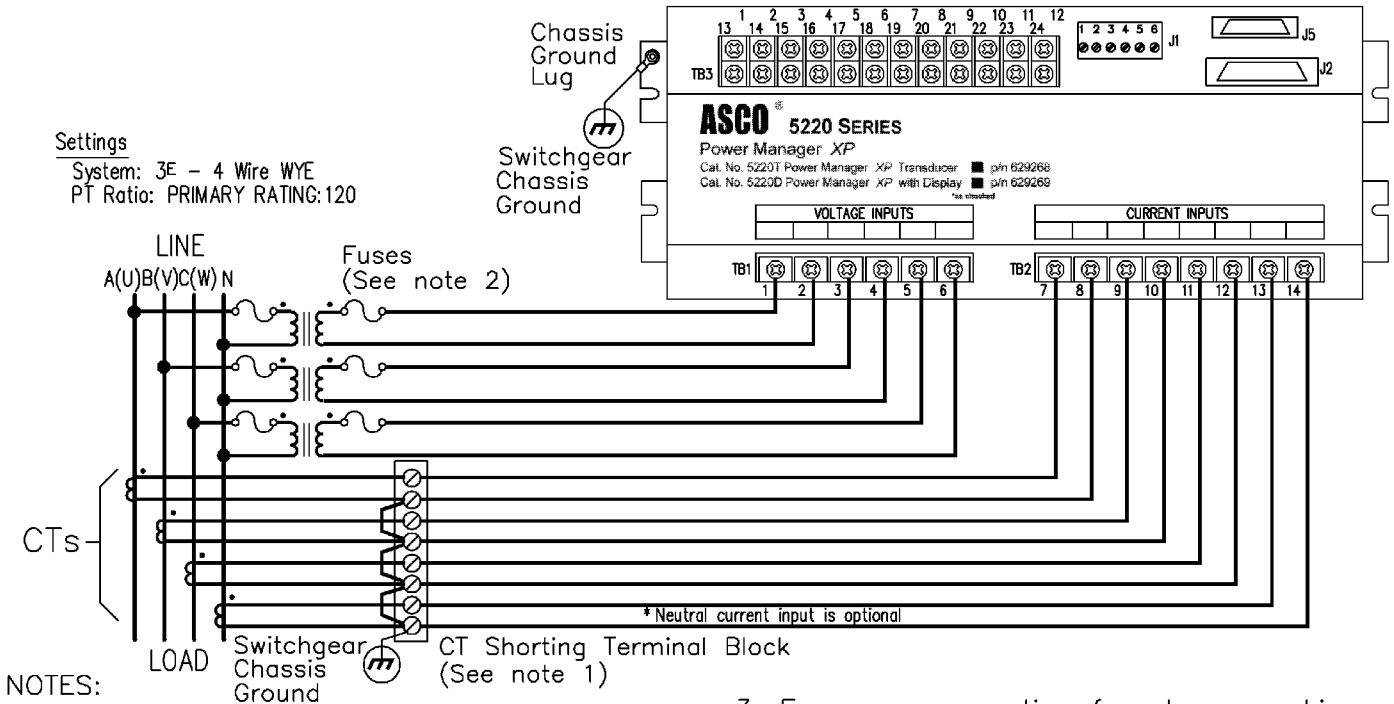

- NOTES:
1. A shorting terminal block is recommended at the CT location.
 2. Voltage inputs require 1Amp/600V fuses.
 3. European convention for phase marking, UVW, shown in parenthesis next to A,B,C markings.

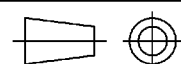
PROJECT NAME:				CHANGE LETTER	ECN NO.	BY	APP.	DATE
WIRING DIAGRAM Power Manager Xp				 THIRD ANGLE PROJECTION				
MANUFACTURING TOLERANCES TO BE IN ACCORDANCE WITH ASCO PROCEDURE MP-1-003. FOR PLASTIC PARTS SEE MP-1-055				SUBSIDIARY DISTRIBUTION				
PROPERTY OF ASCO POWER TECHNOLOGIES. USE PERMITTED FOR OUR WORK ONLY. ALL RIGHTS OF DESIGN OR INVENTION ARE RESERVED.				AE	AN	AM	AJ	AL
ASCO [®] ASCO POWER TECHNOLOGIES, L.P. FLORHAM PARK, NEW JERSEY 07932 U.S.A.				CH	AV	AA	PS	AR
COMPUTER GENERATED DRAWING				AG	AP	AC	AS	
BY	DATE	ASSEM. REF. NO.		SCALE None		ACAD		FILE _03
DRAWN BY	SC	12/00		SIZE	DWG. NO.		AS 629455	
CHECKED				CHANGE LETTER	F	ECN NO.	209529	SHEET 3 OF 6
DRAFTING APPROVAL								
FINAL APPROVAL	RS	12/00						

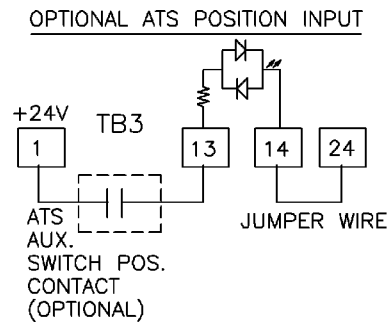
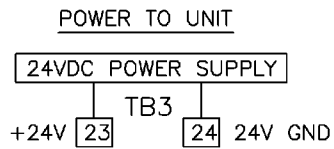
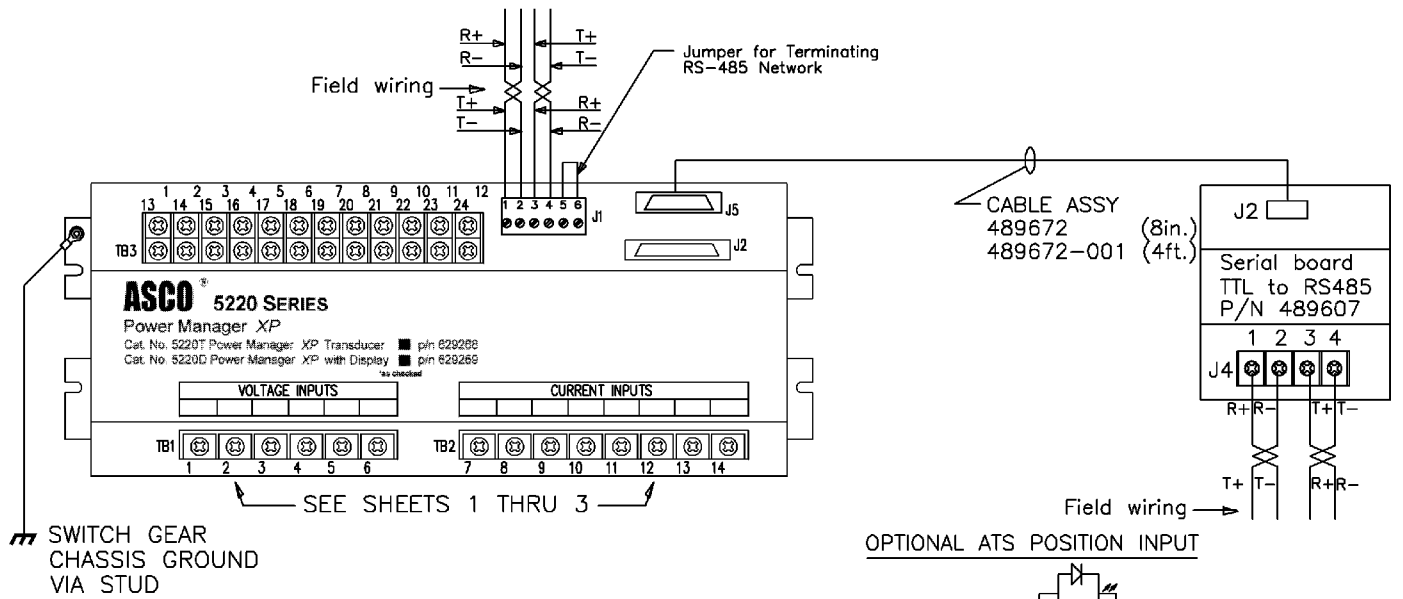

TYPICAL DISCRETE OUTPUT WIRING

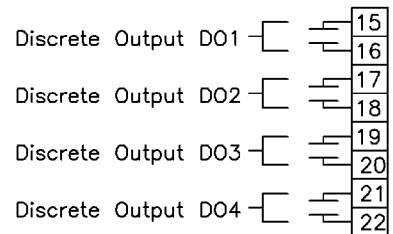

TYPICAL DISCRETE INPUT WIRINGS

See sheet 5 of 6

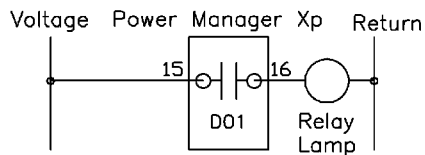

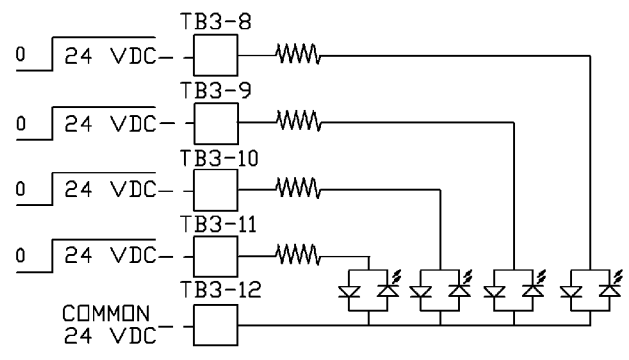
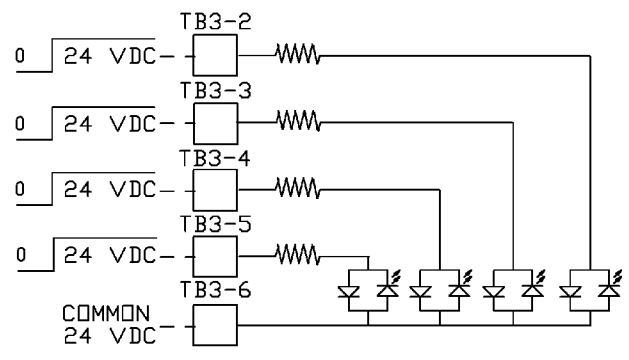

PROJECT NAME:				CHANGE LETTER	ECN NO.	BY	APP.	DATE
WIRING DIAGRAM				SUBSIDIARY DISTRIBUTION				
Power Manager Xp				AE <input type="checkbox"/>	AN <input type="checkbox"/>	AM <input type="checkbox"/>	AJ <input type="checkbox"/>	AL <input type="checkbox"/>
				CH <input type="checkbox"/>	AV <input type="checkbox"/>	AA <input type="checkbox"/>	PS <input type="checkbox"/>	AR <input type="checkbox"/>
				AG <input type="checkbox"/>	AP <input type="checkbox"/>	AC <input type="checkbox"/>	AS <input type="checkbox"/>	<input type="checkbox"/>
THIRD ANGLE PROJECTION				COMPUTER GENERATED DRAWING				
BY	DATE	MANUFACTURING TOLERANCES TO BE IN ACCORDANCE WITH ASCO PROCEDURE MP-1-003. FOR PLASTIC PARTS SEE MP-1-055		ASSEM. REF. NO.				
DRAWN BY	SC	12/00			SCALE	None	ACAD	FILE _04
CHECKED			PROPERTY OF ASCO POWER TECHNOLOGIES. USE PERMITTED FOR OUR WORK ONLY. ALL RIGHTS OF DESIGN OR INVENTION ARE RESERVED.		SIZE	DWG. NO.		
DRAFTING APPROVAL					AS 629455			
FINAL APPROVAL	RS	12/00	ASCO POWER TECHNOLOGIES, L.P. FLORHAM PARK, NEW JERSEY 07932 U.S.A.		CHANGE LETTER	F	ECN NO.	209529
				SHEET		4 OF 6		

Typical wiring of Status Inputs with externally supplied 24VDC signal.

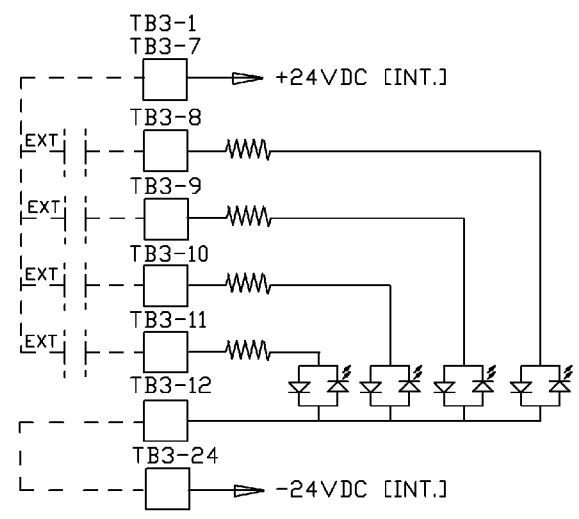
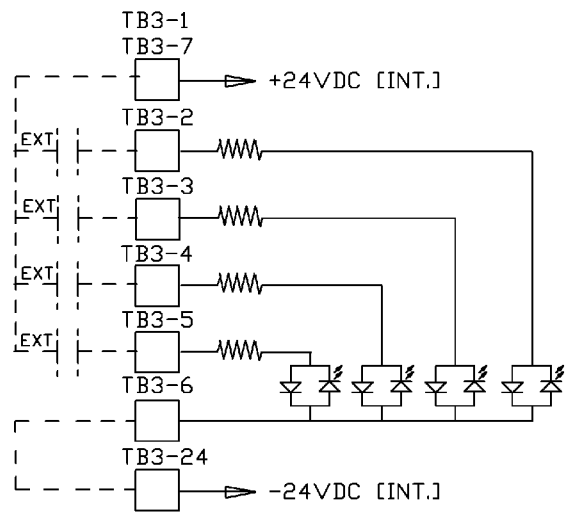

Typical Wiring of Status Inputs using isolated contacts with internal 24VDC power supply.

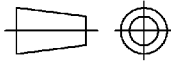

PROJECT NAME:				CHANGE LETTER	ECN NO.	BY	APP.	DATE		
WIRING		DIAGRAM		 THIRD ANGLE PROJECTION					SUBSIDIARY DISTRIBUTION AE <input type="checkbox"/> AN <input type="checkbox"/> AM <input type="checkbox"/> AJ <input type="checkbox"/> AL <input type="checkbox"/> CH <input type="checkbox"/> AV <input type="checkbox"/> AA <input type="checkbox"/> PS <input type="checkbox"/> AR <input type="checkbox"/> AG <input type="checkbox"/> AP <input type="checkbox"/> AC <input type="checkbox"/> AS <input type="checkbox"/>	
Power Manager Xp Serial Data Entry				COMPUTER GENERATED DRAWING						
BY	DATE	MANUFACTURING TOLERANCES TO BE IN ACCORDANCE WITH ASCO PROCEDURE MP-1-003. FOR PLASTIC PARTS SEE MP-1-055		ASSEM. REF. NO.		SCALE None		ACAD	FILE _05	
DRAWN BY	SC	12/00	PROPERTY OF ASCO POWER TECHNOLOGIES. USE PERMITTED FOR OUR WORK ONLY. ALL RIGHTS OF DESIGN OR INVENTION ARE RESERVED.		SIZE DWG. NO.		AS 629455			
CHECKED	WS	12/00			CHANGE LETTER F		ECN NO. 209529		SHEET 5 OF 6	
DRAFTING APPROVAL	SC	12/00			 ASCO POWER TECHNOLOGIES, L.P. FLORHAM PARK, NEW JERSEY 07932 U.S.A.					
FINAL APPROVAL	WP	12/00								

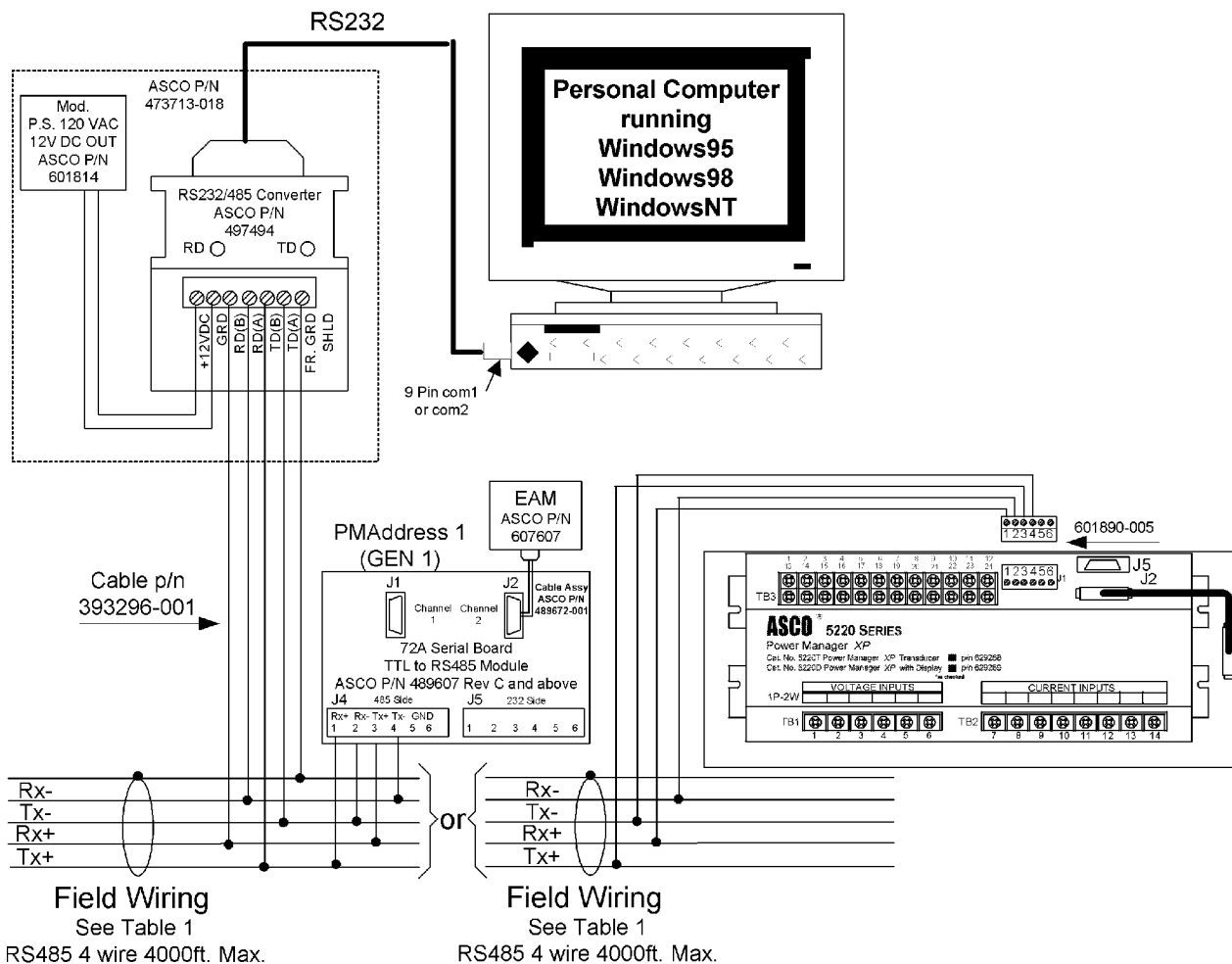

Figure 4

Figure 4 Interface Wiring used with ASCO Software p/n 629398 is required to add entries that can not be made through the Keypad. The following data can be read and written to the Power Manager Xp:

- Power Manager Xp Name
- Power Manager Xp Location
- Digital I/O Names [to provide descriptions for input and output connections].

PROJECT NAME:				CHANGE LETTER	ECN NO.	BY	APP.	DATE
WIRING		DIAGRAM		SUBSIDIARY DISTRIBUTION				
Power Manager Xp		Serial Data Entry		AE	AN	AM	AJ	AL
				CH	AV	AA	PS	AR
				AG	AP	AC	AS	
MANUFACTURING TOLERANCES TO BE IN ACCORDANCE WITH ASCO PROCEDURE MP-1-003. FOR PLASTIC PARTS SEE MP-1-055.				COMPUTER GENERATED DRAWING				
DRAWN BY	SC	DATE	12/00	SCALE		None	ACAD	FILE _06
CHECKED	WS	DATE	12/00	SIZE		DWG. NO.		
DRAFTING APPROVAL	SC	DATE	12/00	AS		629455		
FINAL APPROVAL	WP	DATE	12/00	CHANGE LETTER	F	ECN NO.	209529	SHEET 6 OF 6
ASCO [®] ASCO POWER TECHNOLOGIES, L.P. FLORHAM PARK, NEW JERSEY 07932 U.S.A.								

Control Overview

On the Catalog 5220D Power Manager Xp, which includes the display, six control buttons perform all monitoring and setting functions. Three levels of screens are used. The first (top) level is the *monitoring level* and provides information about the power system. The second (middle) level is the *settings level*. Access to change the settings is password protected (see page 3-1). The third (lower) level is the *setpoints level*. There are twelve user-configurable setpoints for protective relaying, containing two screens per setpoint for parameter selection. A user may configure any combination of these twelve setpoints, including duplicates. Access to these screens is also password protected (see page 3-1).

4-line LCD display

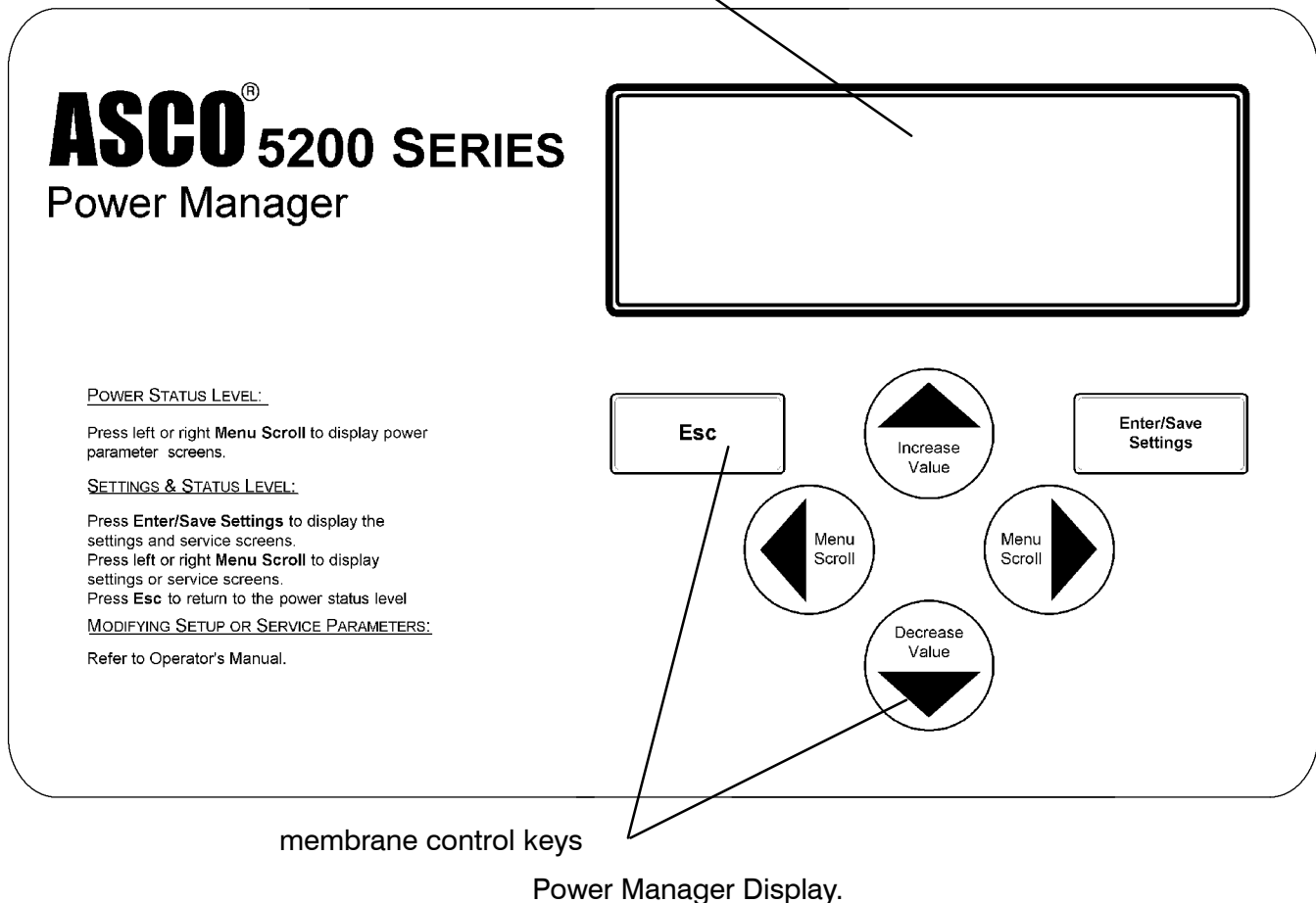

Left-Right Arrows

The left arrow and right arrow keys (*Menu Scroll*) navigate through both levels of screens.

Enter/Save Settings

The **Enter / Save Settings** key drops from the top level to the lower level settings screens. It also is used to save a new settings.

Up-Down Arrows

The up arrow and down arrow keys (*Increase Value* and *Decrease Value*) modifies a setting (setup parameter) while in the lower level screens.

Esc key

The *Esc* key ignores a change and returns to the top level.

Initial Setup

After installing the 5200 Series Power Manager you must set these parameters:

- password (required to change any setting)
- type of electric system (3Ø or 1Ø, 3 or 4 Wire, Wye or Delta)
- source to be monitored (normal, emergency, load, other)
- potential transformer (PT) and current transformer (CT) ratios
- communication parameters (if connected to a PC)
- clear energy parameters (resets base energy level to zero)
- watt demand window size
- nominal settings (KW, volts, amps, frequency)
- setpoint parameters
- date and time







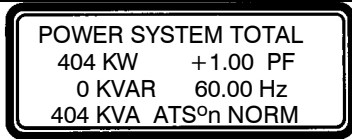

If the Power Manager Xp is preinstalled on the ATS, initial setup has already been done. You should set your password and clear the energy settings, however. Then go to *Operating the Power Manager* on page 4-1.

Password Selection

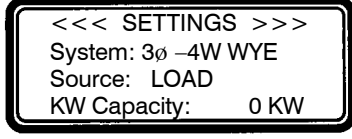
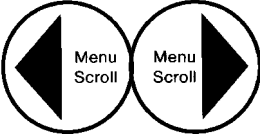
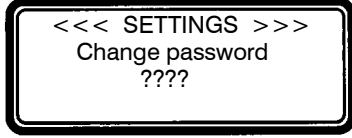
Don't forget the password; write it down!

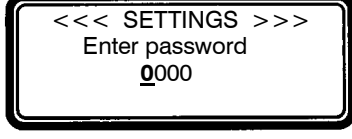
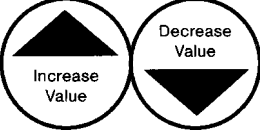
Select a four digit or letter password and record it here _____.
Now change the Power Manager Xp password as follows:

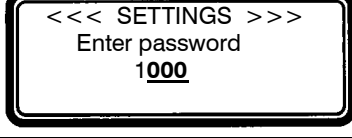
The initial password from the factory is 0000 which is the disabled password state.

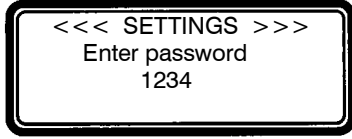
Step	Press	Display Shows	Comment
1			Brings you to top level if not already there.
2			
3			Press left & right arrow keys until password setup location appears.
4			The <u>first</u> digit is blinking.
5			Press up & down arrow keys until correct <u>first</u> digit is displayed.
6			Repeat steps 5 and 6 for the 2nd, 3rd, & 4th digits.
7			Saves the new password.

Now press the Esc key to return to the top level display.

Type of Electrical System and Source to Monitor

Select one electrical system type and one source to monitor as follows:

Electrical System Type

- 3Ø – 4 Wire WYE
- 3Ø – 3 Wire Delta
- 1Ø – 3 Wire
- 1Ø – 2 Wire





Source to be Monitored

- Normal
- Emergency
- Load
- Other

⚠ CAUTION



The transfer switch position indicating auxiliary contact (Feature 14A) must be connected to the Power Manager for proper operation (page 2-2). If not, select *Other* for Source to be monitored.

If incorrect password is entered you will see;
Invalid Password

Step	Press	Display Shows	Comment
1	Esc	POWER SYSTEM TOTAL 404 KW +1.00 PF 0 KVAR 60.00 Hz 404 KVA ATS ^o n NORM	Brings you to top level if not already there.
2	Enter/Save Settings	<<< SETTINGS >>> System: 3ø-4W WYE Source: LOAD KW Capacity: 0 KW	This is the system type and source setup location.
3	Enter/Save Settings	<<< SETTINGS >>> Enter password 0000	Enter password as explained in steps 5 & 6 on page 3-1.
4	Enter/Save Settings	<<< SETTINGS >>> System: 3ø-4W WYE Source: LOAD KW Capacity: 0 KW	System type is blinking.
5	 Increase Value Decrease Value 	<<< SETTINGS >>> System: 3ø-3W Delta Source: LOAD KW Capacity: 0 KW	Press up & down arrow keys until correct system type is selected.
6	Enter/Save Settings	<<< SETTINGS >>> System: 3ø-3W Delta Source: LOAD KW Capacity: 0 KW	Source is blinking.
7	 Increase Value Decrease Value 	<<< SETTINGS >>> System: 3ø-3W Delta Source: NORMAL KW Capacity: 0 KW	Press up & down arrow keys until correct source is selected.
8	Enter/Save Settings	<<< SETTINGS >>> System: 3ø-3W Delta Source: NORMAL KW Capacity: 0 KW	KW Capacity is blinking.

Select system nominal KW capacity (range: 0 – 24999 KW) to be used for setpoint parameters only;

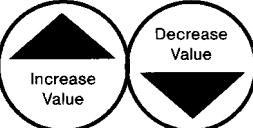





continued on next page.

9		<pre><<< SETTINGS >>> System: 3ø-3W Delta Source: NORMAL KW Capacity: 10000 KW</pre>	Press up & down arrow keys until correct value is selected.
10		<pre><<< SETTINGS >>> System: 3ø-3W Delta Source: NORMAL KW Capacity: 10000 KW</pre>	Saves the new settings. Nothing is blinking.

Now press the **Esc** key to return to the top level display.

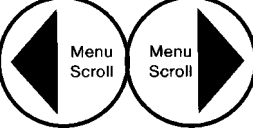
Language Selection

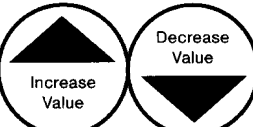
This screen is used to change the display language. The default language is US English. To change the language to Spanish proceed as follows:

Step	Press	Display Shows	Comment
1		<pre>POWER SYSTEM TOTAL 404 KW +1.00 PF 0 KVAR 60.00 Hz 404 KVA ATS^on NORM</pre>	Brings you to top level if not already there.
2		<pre><<< SETTINGS >>> System: 3ø-4W WYE Source: LOAD KW Capacity: 0 KW</pre>	
3		<pre><<< SETTINGS >>> Menu Language ENGLISH</pre>	Press left & right arrow keys until <i>Menu Language</i> appears.
4		<pre><<< SETTINGS >>> Enter password 0000</pre>	Enter password as explained in steps 5 & 6 on page 3-1.
5		<pre><<< SETTINGS >>> Menu Language <u>ENGLISH</u></pre>	The word <u>ENGLISH</u> is blinking.
6		<pre><<< SETTINGS >>> Menu Language <u>SPANISH</u></pre>	Press up & down arrow keys until <u>SPANISH</u> appears.
7		<pre><<< AJUSTES >>> Menu de Lenguaje ESPANOL</pre>	Display changes to Spanish. Saves the new setting. Nothing is blinking.

Now press the **Esc** key to return to the top level display.

Nominal Frequency, Voltage, and Current Settings

Select the nominal system frequency, voltage, and current to be used with the setpoint calculations as follows:

Nominal Frequency

- 50 or 60 Hz









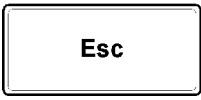
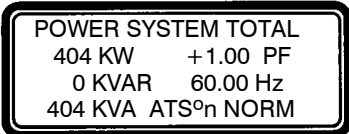

Nominal Voltage

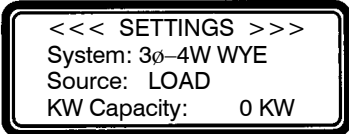
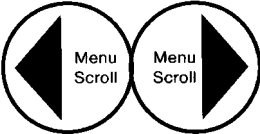
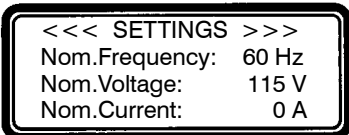
- 69 – 59999* volts

* Starting from Firmware version **-010**, the unit displayed next to the Nominal Voltage value is either **VLL** (for Line to Line = Delta) or **VLN** (for Line to Neutral = WYE). The Nominal Voltage value entered should correspond to the *Electrical System Type* (see page 3-2).

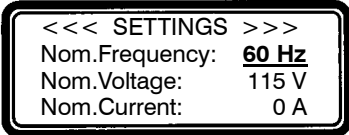
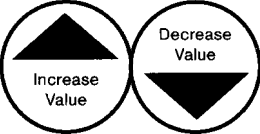
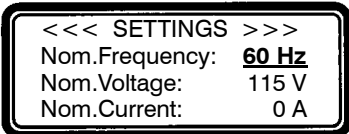
Nominal Current

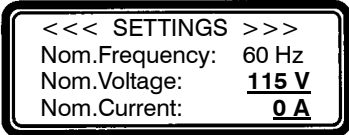
- 0 – 29999 amperes

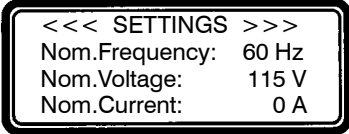
Step	Press	Display Shows	Comment
1			Brings you to top level if not already there.
2			
3			Press left & right arrow keys until nominal settings setup appears.
4			Enter password as explained in steps 5 & 6 on page 3-1.
5			Nom. Frequency is blinking.
6			Press up & down arrow keys until correct frequency is displayed.
7			Repeat steps 6 and 7 for Nom. Voltage and Nom. Current.
8			Saves the new settings. Nothing is blinking.

Now press the **Esc** key to return to the top level display.

PT and CT Ratios

Select the appropriate ratios for the potential transformers (PTs) and current transformers (CTs) connected to the Power Manager as follows:

NOTE:

If Power Manager is connected to a communications network via the SCI (J5) port or the RS-485 (J1) port AND *ASCObus I* protocol is selected, then the PT Ratio must be set to the actual system voltage. For example, for a 480 volt system, set the PT ratio to 480:120. See the next page.









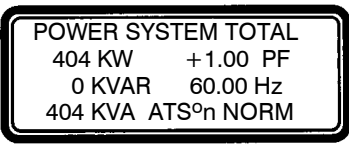

PT Ratios (based upon system voltage, ratio is ___ : 120) See NOTE.

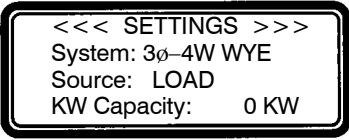
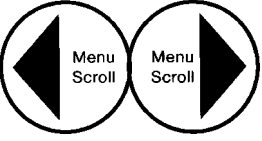
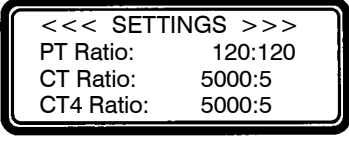
- up to 600 V direct input use 120:120 (maximum is 28200:120)

CT Ratios (based on typical 7000 Series ATS amp size, ratio is ___ : 5)

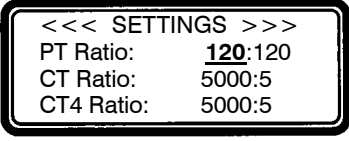
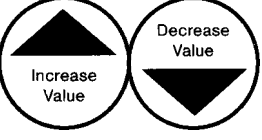
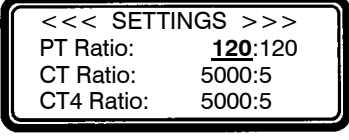
- 30 amp 50:5
- 70 amp 75:5
- 100 amp 100:5
- 150 amp 150:5
- 260 amp 300:5
- 400 amp 400:5
- 600 amp 600:5
- 800 amp 800:5
- 1000 amp 1200:5
- 1200 amp 1200:5
- 1600 amp 2000:5
- 2000 amp 2000:5
- 3000 amp 3000:5
- 4000 amp 4000:5
- maximum is 65000:5

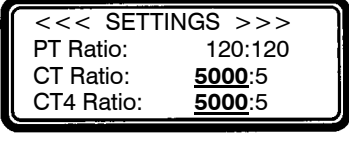
CT4 Ratio (auxiliary CT for neutral connection, if used)

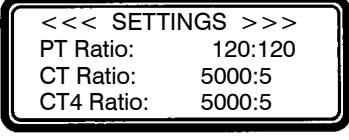
Step	Press	Display Shows	Comment
1			Brings you to top level if not already there.
2			
3			Press left & right arrow keys until PT & CT setup location appears.
4			Enter password as explained in steps 5 & 6 on page 3-1.
5			The PT ratio is blinking.
6			Press up & down arrow keys until correct number is displayed.
7			Repeat steps 5 and 6 for the CT and CT4 ratios.
8			Saves the new settings. Nothing is blinking.

Now press the **Esc** key to return to the top level display.

Serial Communication Interface (SCI) port J5

If the Power Manager is connected to a communications network via the SCI (J5) port, select the appropriate protocol, baud rate, and address for the port as follows:

Protocol

- ASCOBus I** – Enters the Power Manager in an ASCO I/O Module emulation mode when used on ATs with Group 7A Controllers, I/O Modules, and ASCO VPi and PQ2000.



Note: The Power Manager must be connected and configured as a 3Ø – 3 Wire Delta System for this protocol. PT ratios must be set to actual system voltage. For example, for a 480 V system, the PT ratio must be set at 480:120. See the previous page. for this protocol. The I/O Module (Catalog 214A402) uses only a delta system and its PT ratio can only be set by changing transformers.
- ASCOBus II** – New ASCO serial communications protocol used on all latest devices and software packages such as VPi-SYNCHROPOWER.
- Modbus RTU** – Choose this selection when the Power Manager is to be used on a network that communicates via the Modbus RTU protocol. Contact ASCO Power Technologies to obtain a document detailing the corresponding Modbus protocol Register map definitions.

Baud Rate





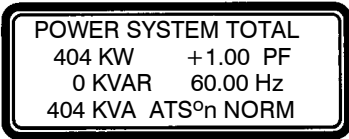
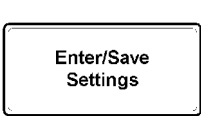
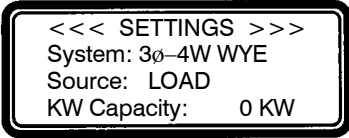
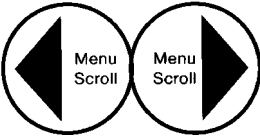
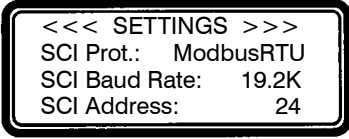

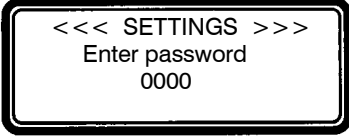
- off, 9600, or 19.2K

Address

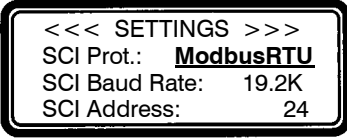
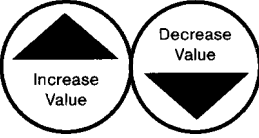
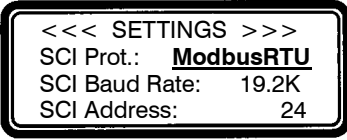
- 1-239 (unique for each Power Manager)
- Note: ASCOBusI address 0-31 only*

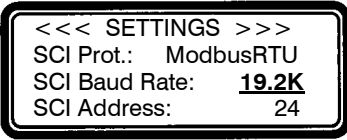
Step	Press	Display Shows	Comment
1			Brings you to top level if not already there.
2			
3			Press left & right arrow keys until baud & address setup appears.
4			Enter password as explained in steps 5 & 6 on page 3-1.

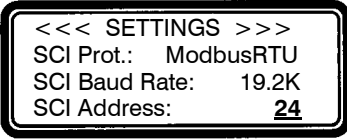
NOTE: If *ASCOBus I* is selected, the *Baud Rate* must be set at 9600.

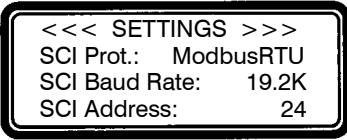
5			The protocol is blinking.
6			Press up & down arrow keys until correct number is displayed.
7			Repeat steps 5 and 6 for the baud rate (see Note).
8			Repeat steps 5 and 6 for the address.
9			Saves the new settings. Nothing is blinking.

Now press the **Esc** key to return to the top level display.

RS-485 Serial Communication Interface (J1)

If the Power Manager is connected to a communications network via the RS-485 (J1) port, select the appropriate protocol, baud rate, and address for the port as follows:

Protocol

- **ASCOBus I** – Enters the Power Manager in an ASCO I/O Module emulation mode when used on ATs with Group 7A Controllers, I/O Modules, and ASCO VPi and PQ2000.

Note: The Power Manager must be connected and configured as a 3Ø – 3 Wire Delta System for this protocol.

PT ratios must be set to actual system voltage.

For example, for a 480 V system, the PT ratio must be set at 480:120. See the previous page.

for this protocol. The I/O Module (Catalog 214A402) uses only a delta system and its PT ratio can only be set by changing transformers.

- **ASCOBus II** – New ASCO serial communications protocol used on all latest devices and software packages such as VPi-SYNCHROPOWER.
- **Modbus RTU** – Choose this selection when the Power Manager is to be used on a network that communicates via the Modbus RTU protocol. Contact ASCO Power Technologies to obtain a document detailing the corresponding Modbus protocol Register map definitions.



Baud Rate

- off, 9600, 19.2K, 38.4K, 57.6K





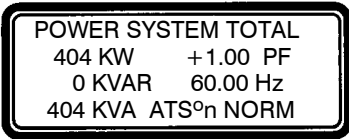
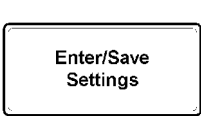
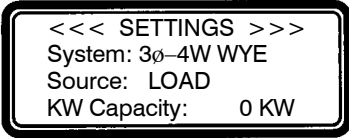
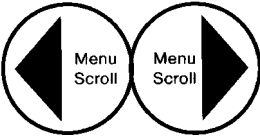
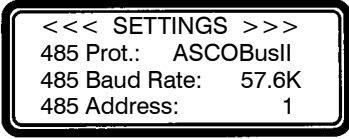

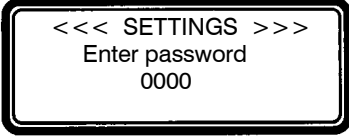
Address

- 1-239 (unique for each Power Manager)

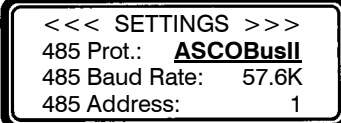
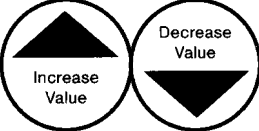
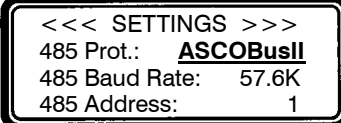
Note: ASCOBusI address 0-31 only

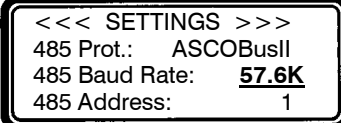
Step	Press	Display Shows	Comment
1			Brings you to top level if not already there.
2			
3			Press left & right arrow keys until baud & address setup appears.
4			Enter password as explained in steps 5 & 6 on page 3-1.

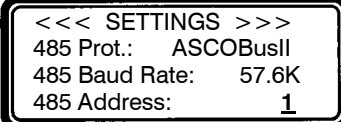
NOTE: If *ASCOBus I* is selected, the *Baud Rate* must be set at 9600.

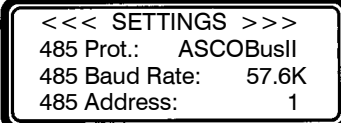
5			The protocol is blinking.
6			Press up & down arrow keys until correct number is displayed.
7			Repeat steps 5 and 6 for the baud rate (see Note).
8			Repeat steps 5 and 6 for the address.
9			Saves the new settings. Nothing is blinking.

Now press the **Esc** key to return to the top level display.

Reset Energy Level, Reset Event Log, Set Backlighting

Reset Energy Level









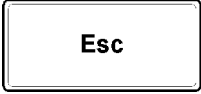
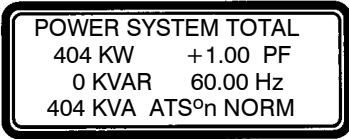

- Energy registers are updated approximately once per second and stored into non-volatile (EEPROM) storage once every 15 minutes. This screen allows the user to clear the Power Manager Xp's non-volatile memory for base energy level.

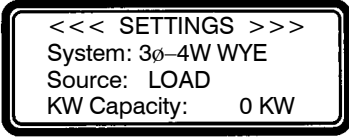
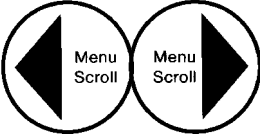
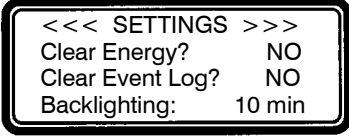
Reset Event Log

- The Event Log records setpoint activity (parameter, cause, time/date stamp) and holds a maximum of 100 most recent events. This screen allows the user to manually clear this log.

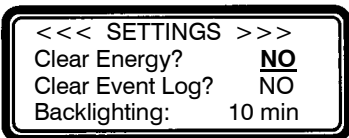
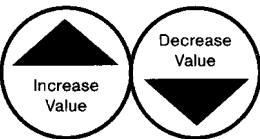
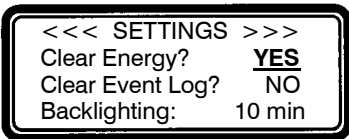
Backlighting

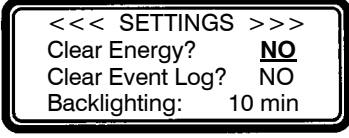
- The Backlighting setting determines the length of time the LCD backlight stays active when the unit is unattended. You can select OFF, ON (continuous), or 1–1999 minutes.

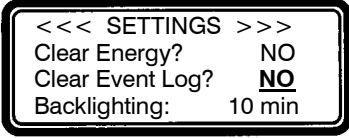

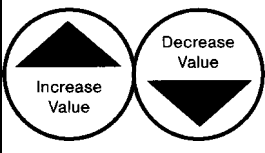
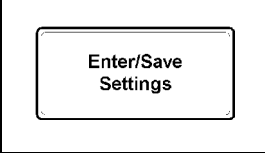
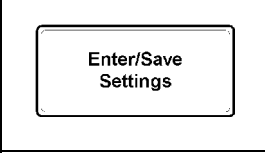
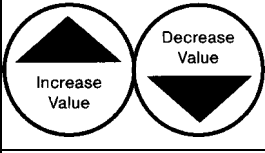
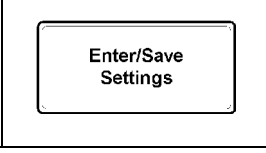







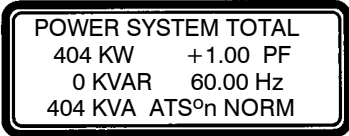

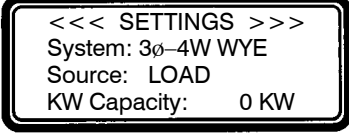
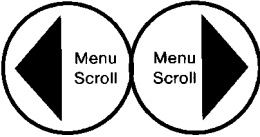
Step	Press	Display Shows	Comment
1			Brings you to top level if not already there.
2			
3			Press left & right arrow keys until the clear energy location appears.
4			Enter password as explained in steps 5 & 6 on page 3–1.
5			The Clear Energy word <u>NO</u> is blinking.
6			Press up & down arrow keys until the word <u>YES</u> appears.
7			Clears energy register to 0. Changes back to NO.
8			The Clear Event Log word <u>NO</u> is blinking.

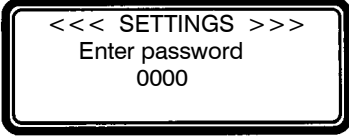
9		<pre> <<< SETTINGS >>> Clear Energy? NO Clear Event Log? YES Backlighting: 10 min </pre>	Press up & down arrow keys until the word YES appears.
10		<pre> <<< SETTINGS >>> Clear Energy? NO Clear Event Log? NO Backlighting: 10 min </pre>	Clears event log. Changes back to NO.
11		<pre> <<< SETTINGS >>> Clear Energy? NO Clear Event Log? NO Backlighting: 10 min </pre>	The backlighting <u>minutes</u> is blinking.
12		<pre> <<< SETTINGS >>> Clear Energy? NO Clear Event Log? YES Backlighting: 10 min </pre>	Press up & down arrow keys until the desired minutes appears.
13		<pre> <<< SETTINGS >>> Clear Energy? NO Clear Event Log? NO Backlighting: 10 min </pre>	Saves the new settings. Nothing is blinking.

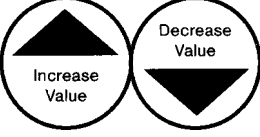
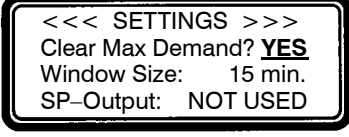
Now press the Esc key to return to the top level display.

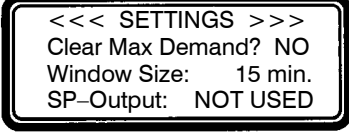
Reset Maximum Demand Level

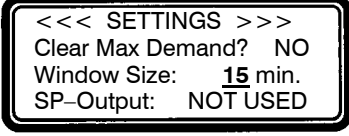

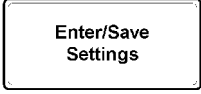
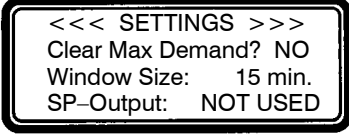





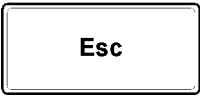
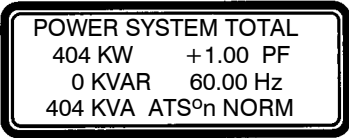

The maximum watt demand register stores the largest instantaneous watt demand value since last power-up or manual reset. Manual reset is accomplished by the following procedure:

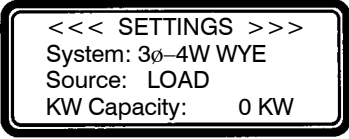
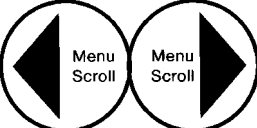
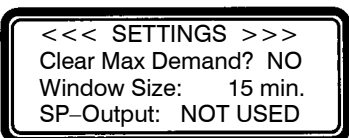
Step	Press	Display Shows	Comment
1			Brings you to top level if not already there.
2			
3			Press left & right arrow keys until the <i>Clear Max Demand</i> location appears.
4			Enter password as explained in steps 5 & 6 on page 3-1.
5			The word <u>NO</u> is blinking.
6			Press up & down arrow keys until the word <u>YES</u> appears.
7			Clears max demand to 0. Changes back to NO.
8			Window Size is blinking.
9			SP-Output is blinking.
10			Saves the new setting. Nothing is blinking.

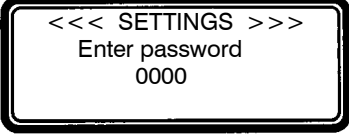
Now press the **Esc** key to return to the top level display.

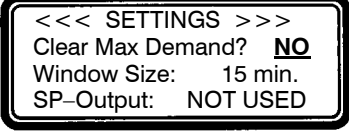
Watt Demand Window Size

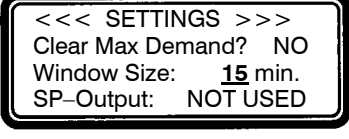
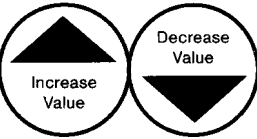
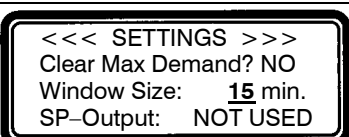
The integration time period for the watt demand calculation is user selectable from one to fifteen minutes in one minute increments. It is recommended that the user selects this option to be one-third of the billing interval. Set this option as follows:

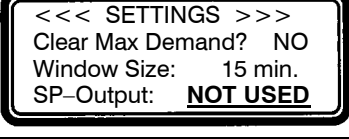
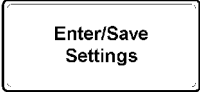
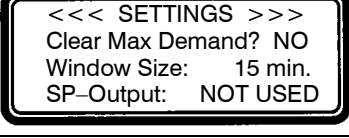
Step	Press	Display Shows	Comment
1			Brings you to top level if not already there.
2			
3			Press left & right arrow keys until the <i>Clear Max Demand</i> location appears.
4			Enter password as explained in steps 5 & 6 on page 3-1.
5			The word <u>NO</u> is blinking.
6			Window Size is blinking.
7			Press up & down arrow keys until correct number is displayed.
8			SP-Output is blinking.
9			Saves the new setting. Nothing is blinking.

Now press the Esc key to return to the top level display.

Setpoint Configuration







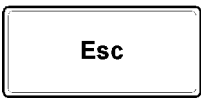
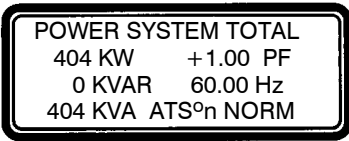

Twelve user-configurable setpoints are available. The operator can select any combination of parameters from the following list:

- KW overload prealarm
- KW overload alarm
- over voltage
- under voltage
- over frequency
- under frequency
- reverse power
- reverse VARS
- reverse over current
- negative sequence over current
- negative sequence voltage

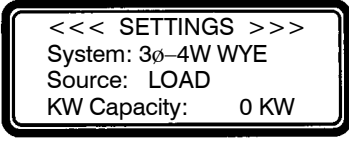
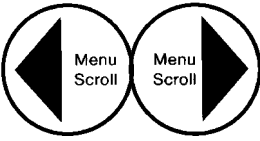
Additionally, the 8 digital inputs and switch-position input can be used as setpoints. Each setpoint allows the user to select:

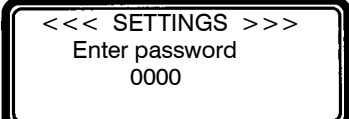
- the parameter
- the trip level
- the reset level
- the trip time delay
- the reset time delay
- the digital output

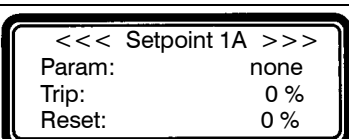
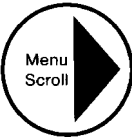
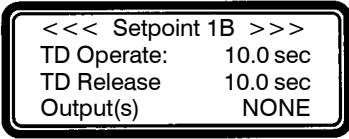
The user can select any combination of the four available digital outputs and choose whether an acknowledgment is required to reset a tripped setpoint.

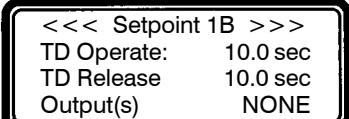





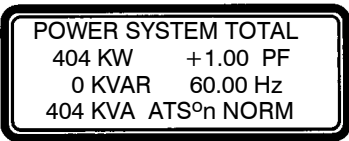

Step	Press	Display Shows	Comment
1			Brings you to top level if not already there.
2			
3			Press left & right arrow keys until Setpoints setup location appears.
4			Enter password as explained in steps 5 & 6 on page 3-1.
5			First setpoint screen 'A'.
6			Press right arrow key. Second setpoint screen 'B'.
7			Saves the settings. Nothing is blinking.

Now press the **Esc** key to return to the top level display.

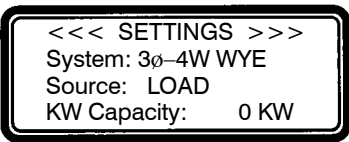
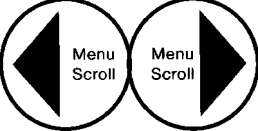
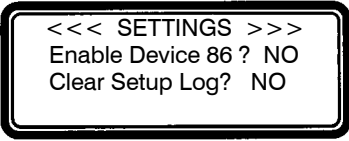
Device 86 Configuration

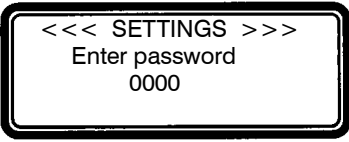
The Device 86 feature, when enabled, latches output relay 1 closed whenever any setpoint configured to output relay 1 is tripped. The latch is only released by a user acknowledgement which can only occur if the condition causing the trip has met reset conditions. Device 86 is reset by the user at the Device 86 status screen on top level of display (see page 4-1).

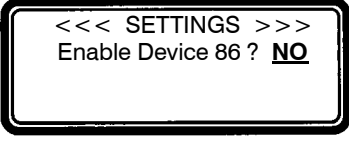
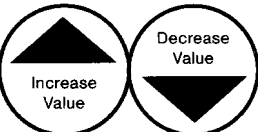
The Device 86 configuration screen allows the user to enable or disable the feature.

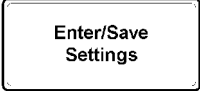
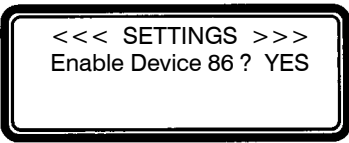







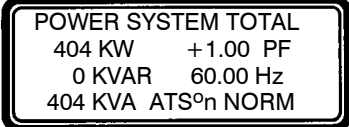

Step	Press	Display Shows	Comment
1			Brings you to top level if not already there.
2			
3			Press left & right arrow keys until <i>Device 86</i> setup location appears.
4			Enter password as explained in steps 5 & 6 on page 3-1.
5			The word <u>NO</u> is blinking.
6			Press up or down arrow keys to change the setting.
7			Saves the settings. Nothing is blinking.

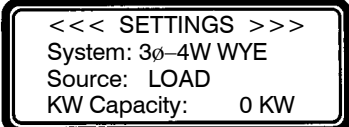
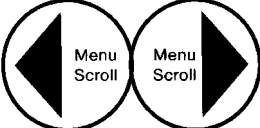
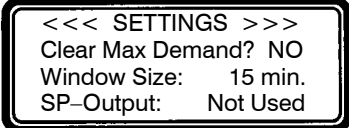
Now press the **Esc** key to return to the top level display.

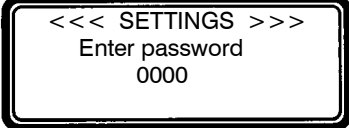
KW Setpoint Configuration

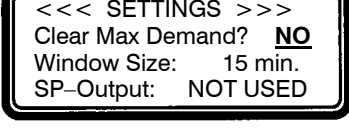
The *Power Manager Xp* provides the user with a dedicated programmable setpoint based on Watt Demand. With this setpoint function, the user can program the Power Manager to control one of the four built-in relays. When the watt demand register exceeds the SP-KWDemand Hi setting, the selected relay closes, and stays closed until the Watt Demand register falls below the SP-KWDemand Lo setting for a preset amount of time determined by the SP-Reset TD setting, upon which the relay opens (or releases).* Select the output relay to be used for the setpoint function (choices include, DO1, DO2, DO3, DO4, or NOT USED) as follows:

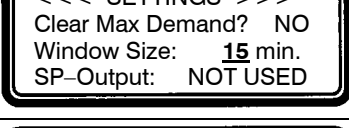
* Note that the selected relay will remain closed if another setpoint is configured to use it and if it is tripped.

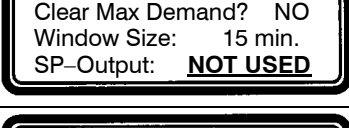
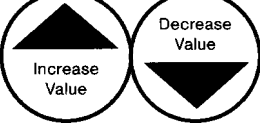
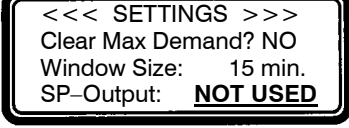
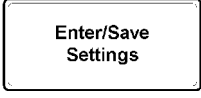
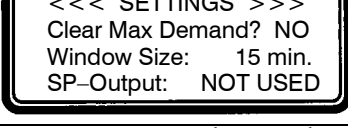
Step	Press	Display Shows	Comment
1			Brings you to top level if not already there.
2			
3			Press left & right arrow keys until the <i>Clear Max Demand</i> location appears.
4			Enter password as explained in steps 5 & 6 on page 3-1.
5			The word <u>NO</u> is blinking.
6			Window Size is blinking.
7			SP-Output is blinking.
8			Press up & down arrow keys until correct output relay is displayed.
9			Saves the new setting. Nothing is blinking.

Now press the **Esc** key to return to the top level display.

KW Demand High/Low Setpoints and Reset Time Delay

Selects the limits at which the SP-Output relay closes and opens. Refer to page 3-10. Set the Power Manager Xp's KW demand setpoints and reset time delay as follows (software prevents the *Hi* point from being set below the *Lo* point and it prevents the *Lo* point from being set above the *Hi* point):

High Setpoint (*SP-KWDemand Hi*) relay closes







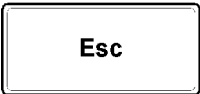
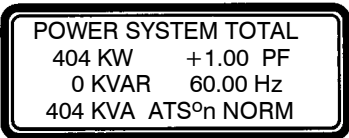
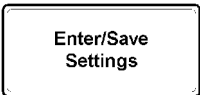
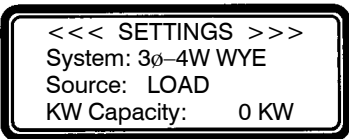
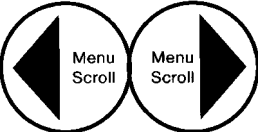
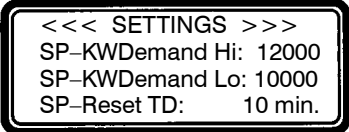

- Range maximum: 32,000 Kilowatts
 minimum: SP-KWDemand Lo setpoint + 1 Kilowatt

Low Setpoint (*SP-KWDemand Lo*) relay opens

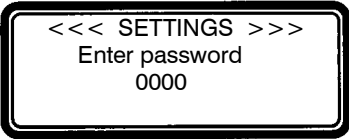
- Range maximum: SP-KWDemand Hi setpoint – 1 Kilowatt
 minimum: 1 Kilowatt

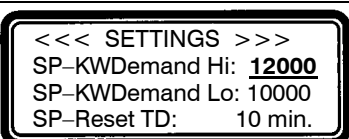
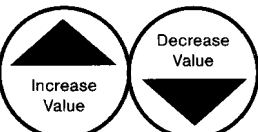
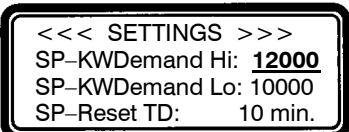
Reset Time Delay (*SP-Reset TD*) delay on relay opening after a low

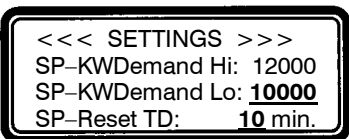

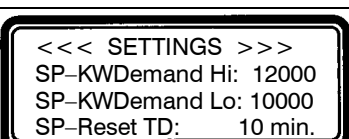





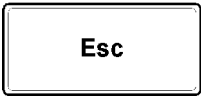
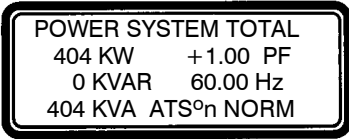

- 0 to 99 minutes (in 1 minute increments) condition is met.

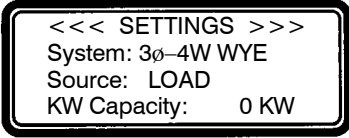
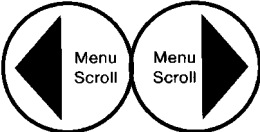
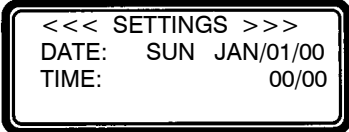
Step	Press	Display Shows	Comment
1			Brings you to top level if not already there.
2			
3			Press left & right arrow keys until <i>SP-KW Demand</i> location appears.
4			Enter password as explained in steps 5 & 6 on page 3-1.
5			The Hi setpoint is blinking.
6			Press up & down arrow keys until correct number is displayed.
7			Repeat steps 5 & 6 for the Lo setpoint and reset time delay value.
8			Saves the new settings. Nothing is blinking.

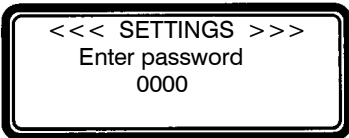
Now press the **Esc** key to return to the top level display.

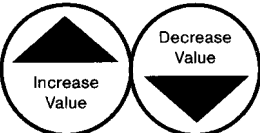
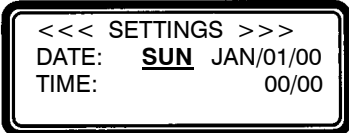
Date and Time Setting



Set the current date and time. This setting is also used as a time stamp when recording log events and maximum watt demand.

Step	Press	Display Shows	Comment
1			Brings you to top level if not already there.
2			
3			Press left & right arrow keys until <i>Date and Time</i> appears.
4			Enter password as explained in steps 5 & 6 on page 3-1.
5			The Day is blinking.
6			Press up & down arrow keys until correct day is displayed.
7			Repeat steps 5 & 6 for the rest of the date and time.
8			Saves the new settings. Nothing is blinking.

Now press the **Esc** key to return to the top level display.

Event Log

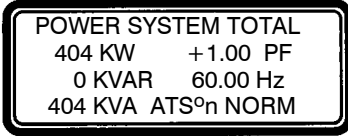

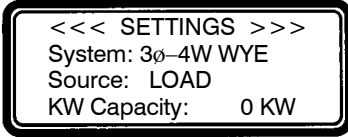
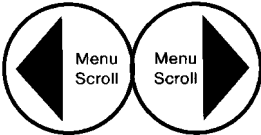
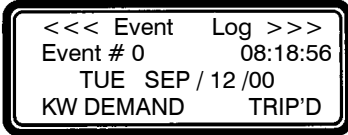
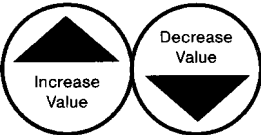
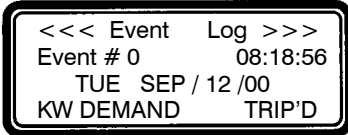
The *Power Manager Xp* contains an event log which records up to 100 events as configured by the setpoints. The events are numbered 0 – 99 with event 0 being the most recent event. When more than 100 events occur, the oldest events are removed to record the newer events.

Step	Press	Display Shows	Comment
1			Brings you to top level if not already there.
2			
3			Press left & right arrow keys until <i>Event Log</i> appears.
4			Press up & down arrow keys to scroll through all recorded events.

Now press the **Esc** key to return to the top level display.

Setup Log

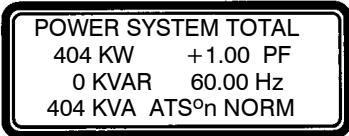

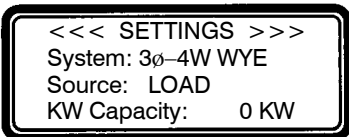
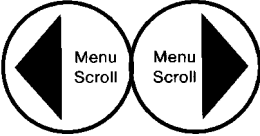
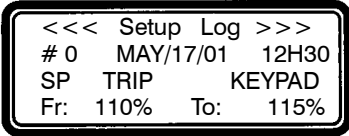
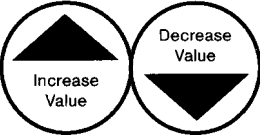
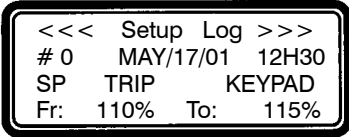







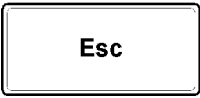
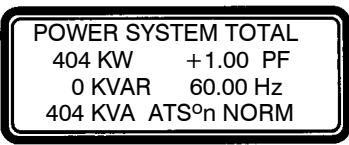

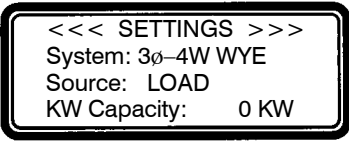
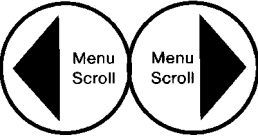
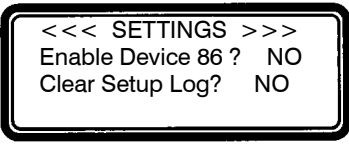
The *Power Manager Xp* contains a setup log which records up to 50 entries. This feature keeps track of changes made by the User to the Setpoints settings or to the Nominal settings. It records a description of the value being changed, the Time & Date stamp of the event, and the Old and New values. The events are numbered 0 – 49 with event 0 being the most recent event. When more than 50 events occur, the oldest events are removed to record the newer events.

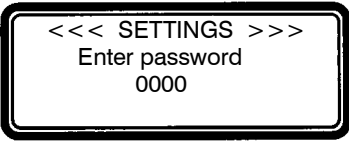
Step	Press	Display Shows	Comment
1			Brings you to top level if not already there.
2			
3			Press left & right arrow keys until <i>Setup Log</i> appears.
4			Press up & down arrow keys to scroll through all recorded events.

Now press the **Esc** key to return to the top level display.

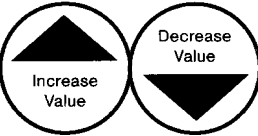
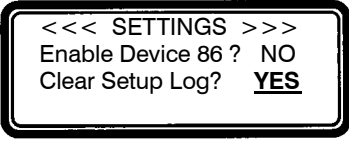
Reset (clear) Setup Log

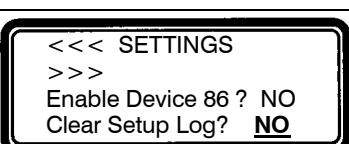
This screen allows the user to manually reset or clear the Setup Log which is described on page 3-20.

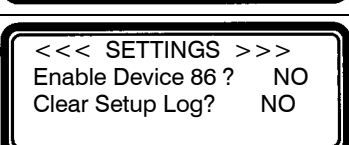
Step	Press	Display Shows	Comment
1			Brings you to top level if not already there.
2			
3			Press left & right arrow keys until clear setup log location appears.
4			Enter password as explained in steps 5 & 6 on page 3-1.
5			The Enable Device 86 word <u>NO</u> is blinking.
6			The Clear Setup Log word <u>NO</u> is blinking.
7			Press up & down arrow keys until the word <u>YES</u> appears.
8			Clears setup log. Changes back to NO.
9			Saves the new settings. Nothing is blinking.







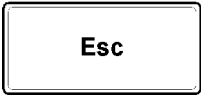
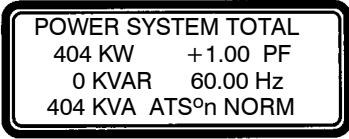

Now press the Esc key to return to the top level display.

Engine Run Time Counter and Reset

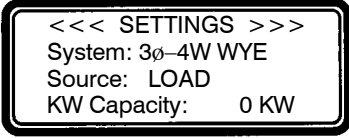
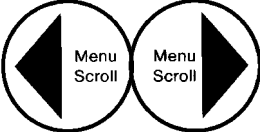
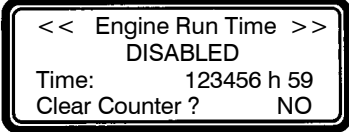
This screen is used only when the Emergency source is monitored by the Power Manager Xp (see page 3–2). It records the total time of the running generator (above 50 % of nominal emergency voltage) in minutes and hours (elapsed time).

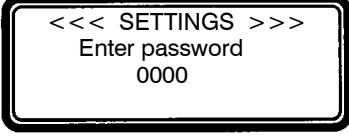
The counter can be turned on or off by selecting *ENABLED* (on) or *DISABLED* (off) as shown below.

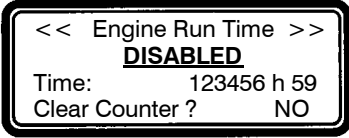
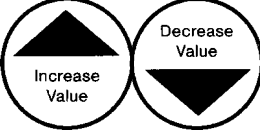
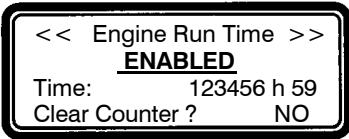
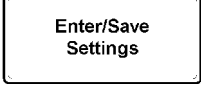
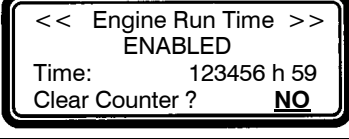
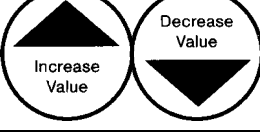
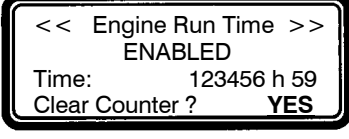
The counter is updated once a minute and the cumulative time is stored in non-volatile memory (EEPROM) every 15 minutes. The counter can be reset to 0 as shown below. After 65,535 hours it resets to 0 automatically.

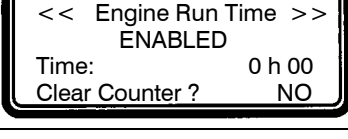
Step	Press	Display Shows	Comment
1			Brings you to top level if not already there.
2			
3			Press left & right arrow keys until <i>Engine Run Time</i> appears.
4			Enter password as explained in steps 5 & 6 on page 3–1.
5			The word <u>DISABLED</u> is blinking.
6			Press up & down arrow keys until word <u>ENABLED</u> appears.
7			The word <u>NO</u> is blinking.
8			Press up & down arrow keys until the word <u>YES</u> appears.
9			Resets the counter to zero. Nothing is blinking.

Now press the **Esc** key to return to the top level display.

Operation

From the top level display the 5200 Series *Power Manager Xp* can show the following information about the electrical power system:

- system totals (kW, kVAR, kVA, PF, Hz, position of ATS)
- current & voltage (line-to-neutral & line-to-line) – all phases
- power (kW), kVARs, kVA, & PF (power factor) – all phases
- Watt demand and maximum Watt demand, and time stamp
- average current & voltage (line-to-neutral & line-to-line)
- unbalance % amps & voltage (line-to-neutral & line-to-line)
- neutral current (if neutral is connected to Power Manager)
- kW hours (imp, exp, net) for Normal & Emergency sources
- kVAR hours (lag, lead, net) for Normal & Emergency sources
- 8 inputs and 4 relay outputs
- active alarms based upon setpoint configurations
- Device 86 status
- ID screen

Data is updated approximately every half second.

These are the screens for a 3 Ø, 4-wire wye system and monitored source is Load. Screens may be different for other electrical systems or other monitored sources.

These screens vary depending on the type of system selected.

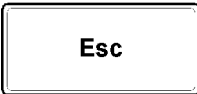
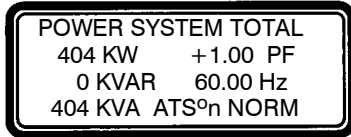
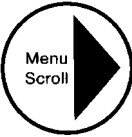
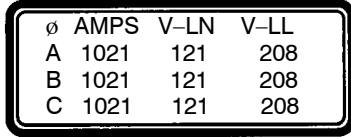
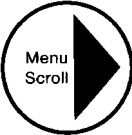
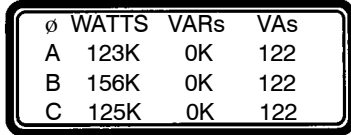
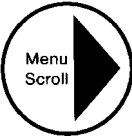
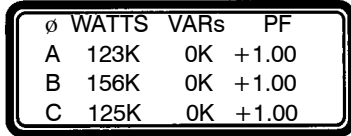
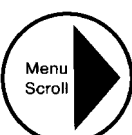
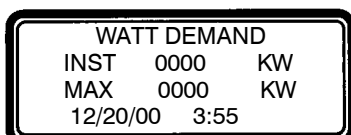
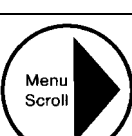
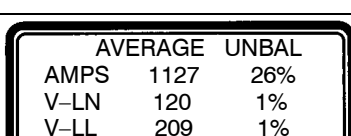
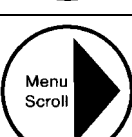
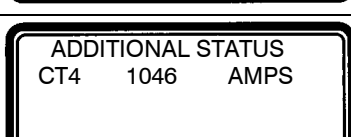
Step	Press	Display Shows	Comment
1			Shows totals for kW, kVARs, kVA, PF, frequency, and position of the ATS.
2			Shows current & voltage (line-to-neutral, line-to-line) all phases.
3			Shows power (kW), kVAR, & VA on all phases.
4			Shows power (kW), kVAR, & power factor on all phases.
5			Shows Watt demand (instantaneous and maximum) and time stamp.
6			Shows average current & voltage (line-to-neutral & line-to-line) .
7			Shows neutral current if neutral is connected to Data Monitor.

Not used for 1 Ø systems.

Not used for 3 Ø, 3-wire or 1 Ø, 2-wire systems.

(continued on next page)

Not used for 1 Ø systems.
Shows line-to-neutral voltage for WYE systems and line-to-line voltage for Delta systems.

Shown only if monitored source is Normal.

Shown only if monitored source is Emergency.

Shown only if monitored source is Normal.

Shown only if monitored source is Emergency.

Only used if monitored source is Load.

8		<div style="border: 1px solid black; padding: 5px;"> <p style="text-align: center;">OVERVIEW</p> <p>277 V LN 607 A</p> <p>404 KW +1.00 PF</p> <p>0 KVAR 60.0 Hz</p> </div>	Shows totals for kW, kVARs, PF, frequency, average current, and average voltage.
9		<div style="border: 1px solid black; padding: 5px;"> <p>KWattHour - Normal</p> <p>IMP = 860</p> <p>EXP = 0</p> <p>NET = 861</p> </div>	Shows normal power usage (kWH) imported, exported, & total.
10		<div style="border: 1px solid black; padding: 5px;"> <p>KWattHour-Emergency</p> <p>IMP = 0</p> <p>EXP = 0</p> <p>NET = 0</p> </div>	Shows emergency power usage (kWH) imported, exported, & total.
11		<div style="border: 1px solid black; padding: 5px;"> <p>KVARHour - Normal</p> <p>LAG = 0</p> <p>LEAD = 0</p> <p>NET = 0</p> </div>	Shows normal VAR usage (kVARHours) lag, lead, & total.
12		<div style="border: 1px solid black; padding: 5px;"> <p>KVARHour-Emergency</p> <p>LAG = 0</p> <p>LEAD = 0</p> <p>NET = 0</p> </div>	Shows emergency VAR usage (kVARHours) lag, lead, & total.
13		<div style="border: 1px solid black; padding: 5px;"> <p>KVAHour - Normal</p> <p>NET = 874</p> <p>KVAHour-Emergency</p> <p>NET = 0</p> </div>	Shows normal & emergency kVA usage (kVA-Hours) totals.
14		<div style="border: 1px solid black; padding: 5px;"> <p>ALARM STATUS</p> <p>No Active Alarms</p> </div>	Shows status of alarms as configured by setpoints.
15		<div style="border: 1px solid black; padding: 5px;"> <p>DEVICE 86 STATUS</p> <p>Disabled</p> <p>Normal</p> </div>	Shows status of Device 86.
16		<div style="border: 1px solid black; padding: 5px;"> <p>Status Input 1:INAC</p> <p>Status Input 2:INAC</p> <p>Status Input 3:ACTV</p> <p>Status Input 4:INAC</p> </div>	Shows the status of inputs 1-4 (INAC=off, ACTV=on).*
17		<div style="border: 1px solid black; padding: 5px;"> <p>Status Input 5:INAC</p> <p>Status Input 6:INAC</p> <p>Status Input 7:INAC</p> <p>Status Input 8:INAC</p> </div>	Shows the status of inputs 5-8 (INAC=off, ACTV=on).*
18		<div style="border: 1px solid black; padding: 5px;"> <p>Relay Output 1:CLSD</p> <p>Relay Output 2:CLSD</p> <p>Relay Output 3:OPEN</p> <p>Relay Output 4:OPEN</p> </div>	Shows status of relay outputs 1-4 (OPEN=off, CLSD=on).*

Now press the Esc key to return to the top level display.

* Power Manager Xps that are connected to PC devices display user-definable status input names, relay labels (15 characters), status (4 characters), name (8 characters), and location (20 characters).

INDEX

A

accessory numbers, 1-1
accuracy, 1-4
address, 3-6, 3-8
ASCOBus I & ASCOBusII, 3-6, 3-8
auxiliary contact, 2-2

B

backlighting, 3-10
baud rate, 3-6, 3-7, 3-8

C

cable, communication, 2-3
catalog numbers, cover
cleaning, 1-2
clear energy, 3-10
clear max demand, 3-12
clear setup log, 3-21
connections, 2-2
 CAUTION statement, 2-2
 communication network, 2-3
 current transformers, 2-2
 ground, 2-3
 output relays, 2-3
 potential transformers, 2-2
 power supply, 2-2
 status input, 2-3
 tightening torque, 2-2
 transformer connections, 2-2
communication, 3-6, 3-8
control power, 2-2
current inputs, 2-2
current levels, 4-1
current transformers, 2-2, 3-5
 DANGER statement, 2-2

D

date and time setting, 3-18
Device 86 configuration, 3-15
Display Catalog 5220D, cover, 1-1, 1-5

E

electrical system type, 3-2
energy level, reset, 3-10
event log, 3-19

F

frequency, 1-4, 1-5, 4-1

H

HELP
 customer@asco.com
 800-800-2726 (ASCO)
Hi setpoint, KW demand, 3-17

I

initial setup, 3-1
inputs, 1-2, 1-5, 2-2, 4-2
introduction, 1-1
 general information, 1-1
 measurement conventions, 1-3
 measurement specifications, 1-4
 device ratings, 1-5

K

KW demand high / low setpoints
 and reset time delay, 3-17
KW setpoint configuration, 3-16

L

labeling, 2-2
Lo setpoint, KW demand, 3-17

M

measurement conventions, 1-3
measurement specifications, 1-4
Modbus RTU, 3-6, 3-8
mounting, 2-1

O

operation, 4-1

P

password selection, 3-1
potential transformers, 2-2, 3-5
power factor, 4-1
power levels, 4-1
power supply, 2-2
power system total, 4-1
protocol, 3-6, 3-8

R

ratings, 1-5
relay outputs, 2-3, 4-2
reset energy level, 3-10
reset event log, 3-10
reset maximum demand level, 3-12
reset time delay, KW demand, 3-17
RS-485 Serial Communication
 Interface, 3-8

S

serial communication interface, 3-6, 3-8
servicing, 1-2
setpoint, KW demand, 3-17
setpoint configuration, 3-14
setpoint output relay, 3-16
setup log, 3-20
SP-KW Demand, 3-17
SP-Output, 3-16
SP-Reset TD, 3-17
source to monitor, 3-2
status inputs, 2-3
settings
 communication, 3-6, 3-8
 ct ratios, 3-5
 electrical system type, 3-2
 pt ratios, 3-5
 reset energy level, 3-10
 source to be monitored, 3-2

T

Transducer Catalog 5220T, cover, 1-1, 1-5
transfer switch position, 2-2, 4-1
 CAUTION statement, 2-2

U

usage, 4-1

V

voltage inputs, 2-3
voltage levels, 4-1

W

watt demand, 1-1, 3-13, 4-1