

XPSLCD1141

Safety light curtains monitoring
module

User's Manual

08/2007



W917063470211A03

Merlin Gerin
Square D
Telemecanique

Schneider
Electric

Table of Contents



	Safety Information	5
	About the Book	7
Chapter 1	Description of XPSLCD1141	11
	At a glance	11
	Description of XPSLCD1141	12
	XPSLCD1141 specifications	14
	Cable lengths	17
	Operating states	18
Chapter 2	Operating and wiring instructions	23
	At a glance	23
	Safety distance	24
	Configuration of XUSL light curtain	25
	Wiring connections	28
	Setting XPSLCD1141 configuration switches	32
	General considerations	34
Chapter 3	Diagnostic display	35
	System diagnostic codes	35
Glossary	37

Safety Information

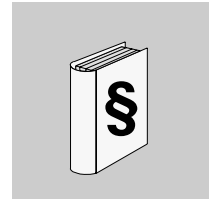

Important Information

NOTICE

Read these instructions carefully, and look at the equipment to become familiar with the device before trying to install, operate, or maintain it. The following special messages may appear throughout this documentation or on the equipment to warn of potential hazards or to call attention to information that clarifies or simplifies a procedure.



The addition of this symbol to a Danger or Warning safety label indicates that an electrical hazard exists, which will result in personal injury if the instructions are not followed.



This is the safety alert symbol. It is used to alert you to potential personal injury hazards. Obey all safety messages that follow this symbol to avoid possible injury or death.

DANGER

DANGER indicates an imminently hazardous situation, which, if not avoided, **will result** in death or serious injury.

WARNING

WARNING indicates a potentially hazardous situation, which, if not avoided, **can result** in death, serious injury, or equipment damage.

CAUTION

CAUTION indicates a potentially hazardous situation, which, if not avoided, **can result** in injury or equipment damage.

PLEASE NOTE

Electrical equipment should be installed, operated, serviced, and maintained only by qualified personnel. No responsibility is assumed by Schneider Electric for any consequences arising out of the use of this material.

© 2007 Schneider Electric. All Rights Reserved.

About the Book

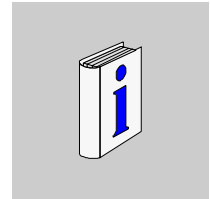

At a Glance

Document Scope The XPSLCD1141 module is a "Type 4" safety device. It is designed to work with safety devices to guard personnel working around moving machinery.

Validity Note The data and illustrations found in this book are not binding. We reserve the right to modify our products in line with our policy of continuous product development. The information in this document is subject to change without notice and should not be construed as a commitment by Schneider Electric.

Product Related Warnings

 WARNING
IMPROPER SET UP OR INSTALLATION Read all responsibilities and requirements listed below before installing the XPSLCD1141 module. Failure to follow these instructions can result in death, serious injury, or equipment damage.

 WARNING
REDUCED PROTECTION LEVEL When the XPSLCD1141 module is used with a Type 2 rated light curtain or another Type 2 device, the overall system protection is reduced to Category 2. Failure to follow these instructions can result in death, serious injury, or equipment damage.

Whether a specific machine application and XPSLCD1141 installation complies with safety regulations depends on several items, including the proper application, installation, maintenance and operation of the XPSLCD1141. These items are the responsibility of the purchaser, installer and employer.

This product is designed to comply with:

- IEC61496-1
- EN954-1
- EN60204-1
- UL TYPE 4 requirements
- CSA

The employer is responsible for the selection and training of personnel to properly install, operate, and maintain the machine and its safeguarding systems.

The XPSLCD1141 should only be installed, verified and maintained by a qualified person, as "a person or persons who, by possession of a recognized degree or certificate of professional training, or who, by extensive knowledge, training or experience, has successfully demonstrated the ability to solve problems relating to the subject matter and work."

To use a XPSLCD1141 module, the following requirements must be met:

Meeting full compliance

- The guarded machine must be able to stop anywhere in its cycle. Do not use an XPSLCD1141 on a press with a full-revolution clutch.
- The guarded machine must not present a hazard from flying parts.
- The guarded machine must have a consistent stopping time and adequate control mechanisms.

- Severe smoke, particulate matter and corrosives may degrade the efficiency of safety devices. Do not use the XPSLCD1141 module and safety devices system in this type of environment.

Employer Responsibilities

- All applicable governmental and local rules, codes, and regulations must be satisfied. This is the employer's responsibility.

Additional Requirements

- All safety-related machine control elements must be designed so that a fault in the control logic or failure of the control circuit does not lead to a failure or danger.
- Additional guarding may be required for access to dangerous areas not covered by the XPSLCD1141 module and safety device system.
- Perform the test procedure at installation and after maintenance, adjustment, repair or modification to the machine controls, tooling, dies or machine, or the XPSLCD1141 and safety device system.
- Perform only the test and repair procedures outlined in this manual.
- Follow all procedures in this manual for proper operation of the XPSLCD1141.

The enforcement of these requirements is beyond the control of the manufacturer. The employer has the sole responsibility to follow the preceding requirements and any other procedures, conditions and requirements specific to his machinery.

User Comments

We welcome your comments about this document. You can reach us by e-mail at techpub@schneider-electric.com

Description of XPSLCD1141



1

At a glance

Overview

This chapter describes the XPSLCD1141.

What's in this Chapter?

This chapter contains the following topics:

Topic	Page
Description of XPSLCD1141	12
XPSLCD1141 specifications	14
Cable lengths	17
Operating states	18

Description of XPSLCD1141

Front panel

XPSLCD1141 Front panel

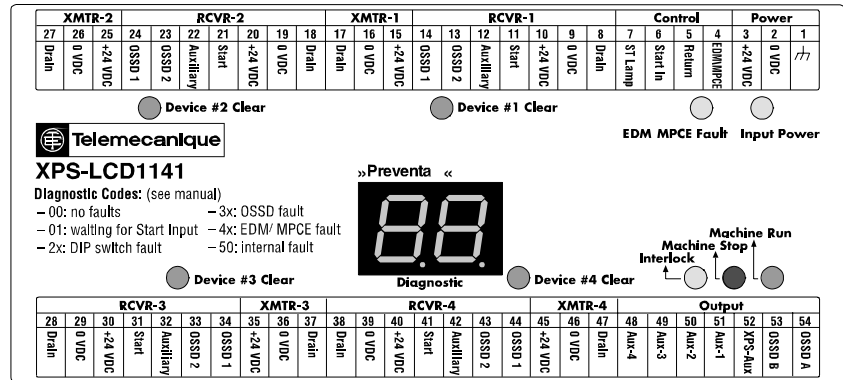

Description

The XPSLCD1141 provides protection for machines with more than one opening to guard. It produces a single pair of OSSD (OSSD A, OSSD B) safety outputs by receiving safety and auxiliary outputs from up to four XUSLT/M/P/N family of light curtains. The XPSLCD1141 is enclosed in a 75 mm W x 150 mm L x 110 mm H (3"W X 5.8"L X 4.3"H) DIN box with two rows of removable terminal blocks. The mode and configuration DIP switches are located inside the box. For DIP switch settings, see *Setting XPSLCD1141 configuration switches, p. 32*.

The XPSLCD1141 module works with up to four independent safety sensing devices identified as safety device 1, safety device 2, safety device 3, and safety device 4. Each safety sensing device (light curtain) has two solid-state, current sourcing type OSSD outputs identified as OSSD 1 and OSSD 2. The OSSD signals conform to 24 V \pm 10 % indicating Machine Run and 0 V indicating Machine Stop.

The XPSLCD1141 is primarily intended to work with the XUSLT family of light curtains, but it can operate with other safety devices that test its OSSD output, including the following other products: the XUSLM, XUSLP and XUSLN light curtain. For the XPSLCD1141 to act as the primary safety device, the safety devices used with the XPSLCD1141 module must be configured in the Automatic Start, interlock mode and have their EDM/MPCE function disabled. The XPSLCD1141 also provides connection for the safety device power, auxiliary, and start signals.

Response time

The response time is < 1 ms. The response time is measured from the time when any safety device transitions to the MACHINE STOP state to the time that the XPSLCD1141 OSSDs are in the OFF state. The XPSLCD1141 controls its OSSDs according to the state of the safety device OSSD inputs. The XPSLCD1141 outputs are only active when all the selected safety device OSSD inputs are active.

XPSLCD1141 specifications

Specifications

Conforming to Standards: IEC61496-1, EN954-1, EN60204-1. Other Approvals: CE/TUV, UL Listed 68DF, CSA

Safety Output:	Two PNP outputs each sourcing 625 mA @ 24 V ---
Auxiliary (non-safety) Output	<ul style="list-style-type: none"> ● NPN output sinking 100 mA @ 24 V ---. ● PNP sourcing 500 mA @ 24 V ---.
EDM/MPCE Monitor	50mA @ 24 V --- (XPSLCD1141 sourcing current)
Maximum Response Time	<1 ms
Resistance to interference	According to IEC61496-1.
Input Power	24 V --- +/- 10% <ul style="list-style-type: none"> ● Power for XPSLCD1141 only: 3 W ● Power for XPSLCD1141 supplying four maximum length XUSLT/M/P/N series safety light curtains and max. loads on outputs: 175 W. (See <i>Power Supply Requirement, p. 15</i>)
Tightening torque (per IEC60999-1)	Control screw terminals: 0.3Nm (2.66 lb-in) recommended.
Start Input	Start switch is a N/C momentary contact switch providing contact closure to the XPSLCD1141 power return. <ul style="list-style-type: none"> ● Current through switch with 1 to 4 light curtains connected to XPSLCD1141: 50mA @ 24 V ---
Materials	Enclosure: Polycarbonate.
Start Required Lamp Output	Current Sinking(NPN) output 500 mA max @ 24V ---
Temperature	0 to 55 degrees C (32 to 131° F)
Relative Humidity	95% maximum, non-condensing
Enclosure Rating	Controller: IP20
Indicator Lights	Machine Run, Machine Stop, Interlock/Fault two-digit diagnostic display, EDM/MPCE Fault, and light curtain OSSD clear LEDs.
Cable terminals	14AWG (1.63mm ²) max. wire size

Power Supply Requirement**Total System Components**

	Full output load + Full temperature range (Worst case)	Reduced output load (1) + Full temperature range
XPSLCD1141 with 1 light barrier (XUSLT, XUSLM, XUSLP or XUSLN)	ABL8RPS24050	ABL8RPS24030 (Iout < 1.75 A)
XPSLCD1141 with 2 light barriers (XUSLT, XUSLM, XUSLP, XUSLN or combination)	ABL8RPS24050 ABL8RPS24100 (2 XUSLM)	ABL8RPS24030 (Iout < 1.1 A) ABL8RPS24050 (Iout < 3 A) (2 XUSLM)
XPSLCD1141 with 3 light barriers (XUSLT, XUSLM, XUSLP, XUSLN or combination)	ABL8RPS24100	ABL8RPS24050 (Iout < 2.2 A)
XPSLCD1141 with 4 light barriers (XUSLT, XUSLM, XUSLP, XUSLN or combination)	ABL8RPS24100	ABL8RPS24050 (Iout < 1.5 A)

Note: (1): Output load I out = XPSLCD1141 OSSD output currents or Start Required Lamp output current (whichever is bigger) + XPS Aux. output current + all light barriers auxiliary output currents

Mechanical drawing

The drawing below gives the XPSLCD1141 dimensions:

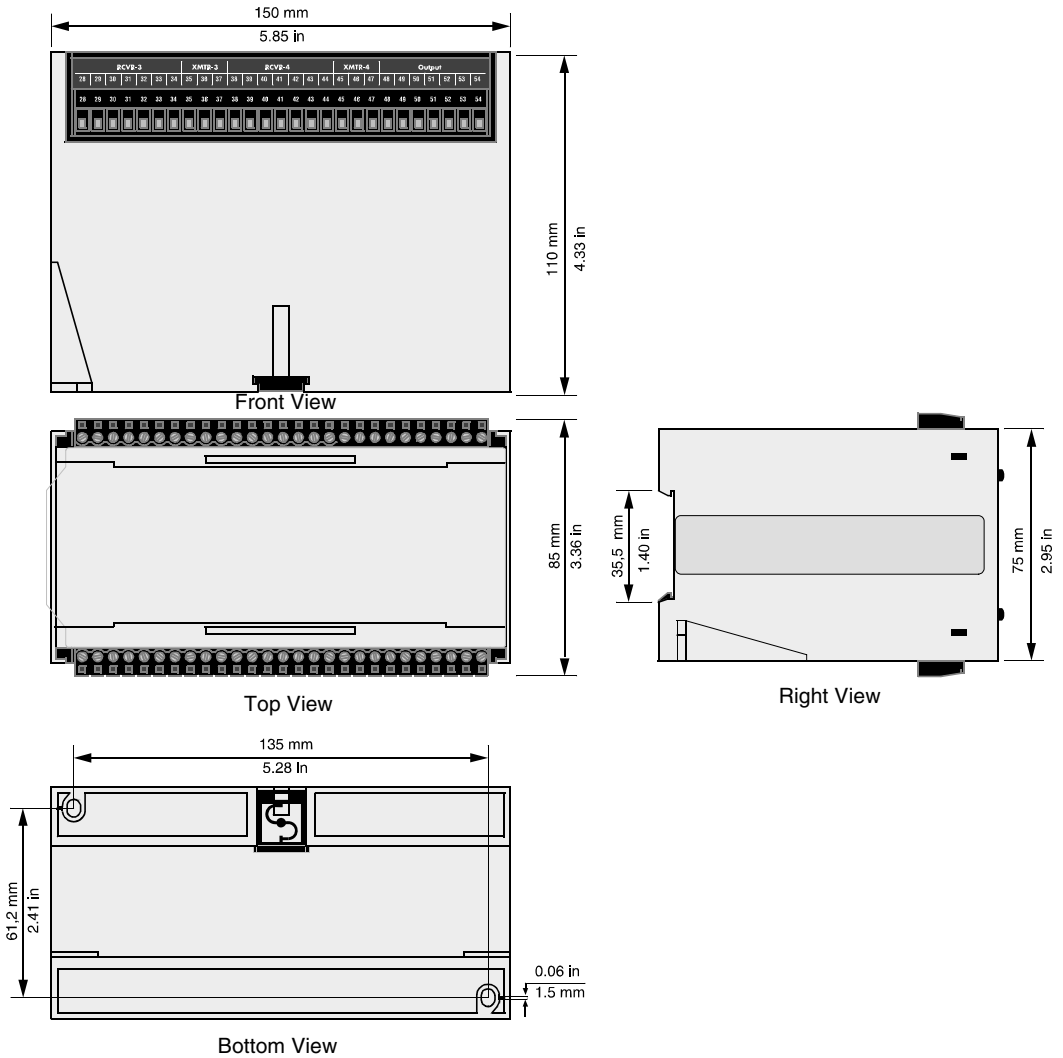

Cable lengths

Input signal cable lengths

- Safety Device OSSD inputs: Use 20 AWG (0.3117 mm²) shielded wire with cable capacitance < 100 pF/ft. (30 pF/m), max length 60m (198 ft)
 - MPCE Monitor input: Use 22 AWG (0.4418 mm²) unshielded wire, max length 10m (33 ft)
 - Start input: Use 22 AWG (0.4418 mm²) unshielded wire, max length 60m (198 ft)
-

Output signal cable lengths

- OSSD A and OSSD B outputs and return: Use 20 AWG (0.3117 mm²) unshielded wire with cable capacitance < 100 pF/ft. (30 pF/m), max length 10m (33 ft)
 - XPSLCD1141 Auxiliary outputs (PNP Out and NPN Out): Use 20 AWG (0.3117 mm²) unshielded wire, max length 10m (33 ft)
 - Start Required lamp output: Use 20 AWG (0.3117 mm²) unshielded wire, max length 60m (198 ft)
-

Operating states

Principle

The XPSLCD1141 module receives outputs from up to four safety devices and produces a single pair of OSSD outputs. The system consists of a DIN box with two rows of removable terminal blocks, and is wired to up to four safety devices. The Output Signal Switching Devices (OSSD A and OSSD B) are XPSLCD1141 components that connect to the machine control system. When a safety device detection zone is interrupted, the XPSLCD1141 OSSD responds by going to the off state. The operating condition of an XPSLCD1141 safety device system is described in terms of states. The following operating states exist for the XPSLCD1141.

Machine run

The green MACHINE RUN indicator is lit, the OSSD outputs are on, and the AUXILIARY output responds in a manner consistent with its set operating mode. The protected machine is allowed to operate. Pressing and releasing the START button has no effect.

Machine stop

The red MACHINE STOP indicator is lit, the OSSD outputs are off, and the AUXILIARY output is off. The protected machine is not allowed to operate. Pressing and releasing the START button has no effect.

Interlock

The yellow INTERLOCK indicator is lit, and the Start Required Lamp output is on. The AUXILIARY output is off. The INTERLOCK state does not allow the protected machine to operate until the START button is pressed and released.

Lockout (Fault)

The yellow INTERLOCK indicator is blinking, and the Start Required lamp is blinking. The AUXILIARY output responds in a manner consistent with its set operating mode. This state does not allow the protected machine to operate until the fault is removed and the START button is pressed and released or power is cycled.

**Corresponding
table**

XPSLCD1141 Operating States and Corresponding Outputs:

Output	Machine Run	Machine Stop	Interlock	Lockout
Green LED: Machine Run	On	Off	Off	Off
Red LED: Machine Stop	Off	On	On	On
Yellow LED: Interlock	Off	Off	On	Blinking
Start Required Lamp Output	Off	Off	On	Blinking
OSSD A Output	On	Off	Off	Off
OSSD B Output	On	Off	Off	Off
XPSLCD1141 Auxiliary Output: ● Follow OSSD Indication Mode ● Fault Indication Mode	On Off	Off Off	Off Off	Off On

Waveform diagram

"Automatic Start/Restart" mode

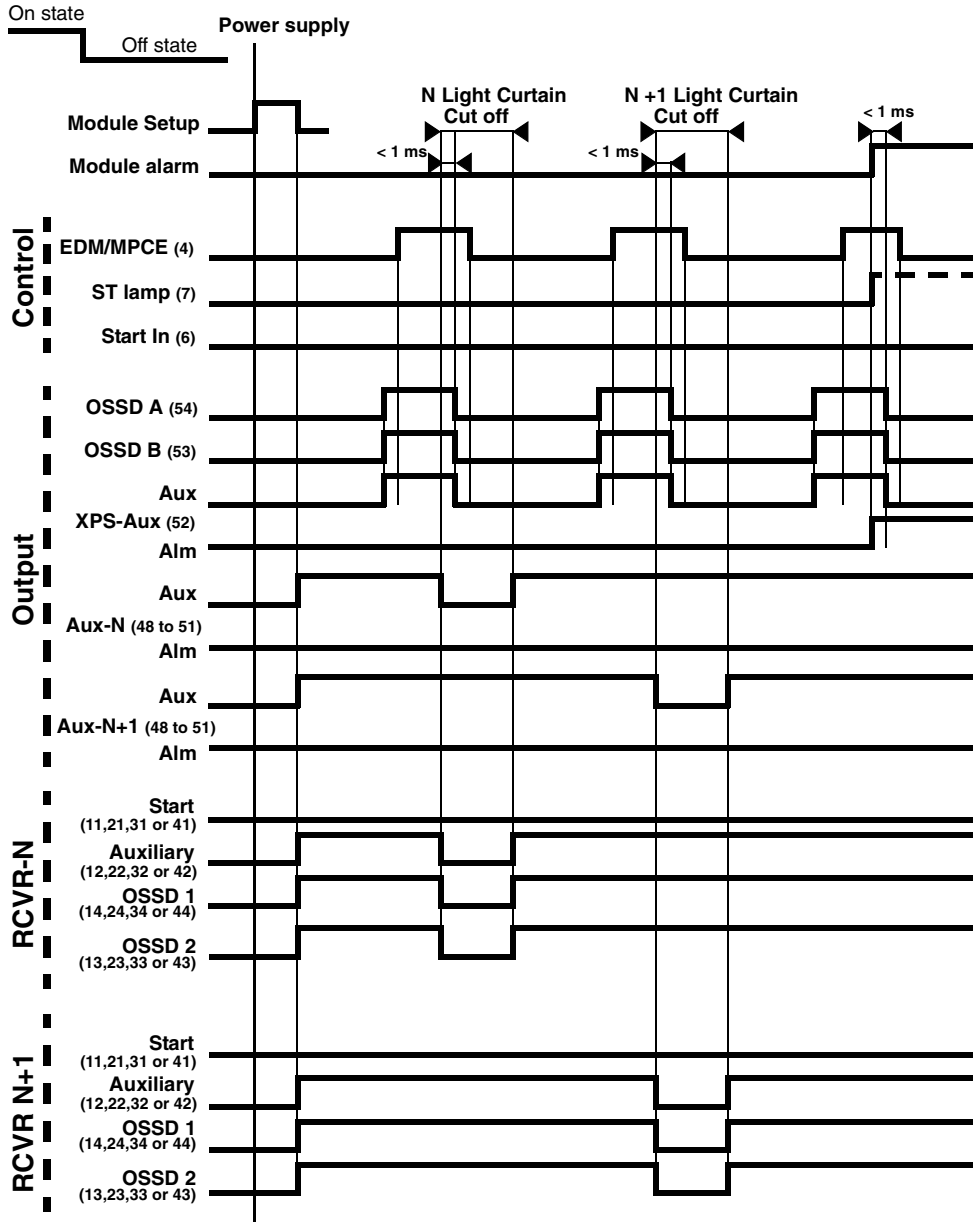

"Start/Restart Interlock" mode

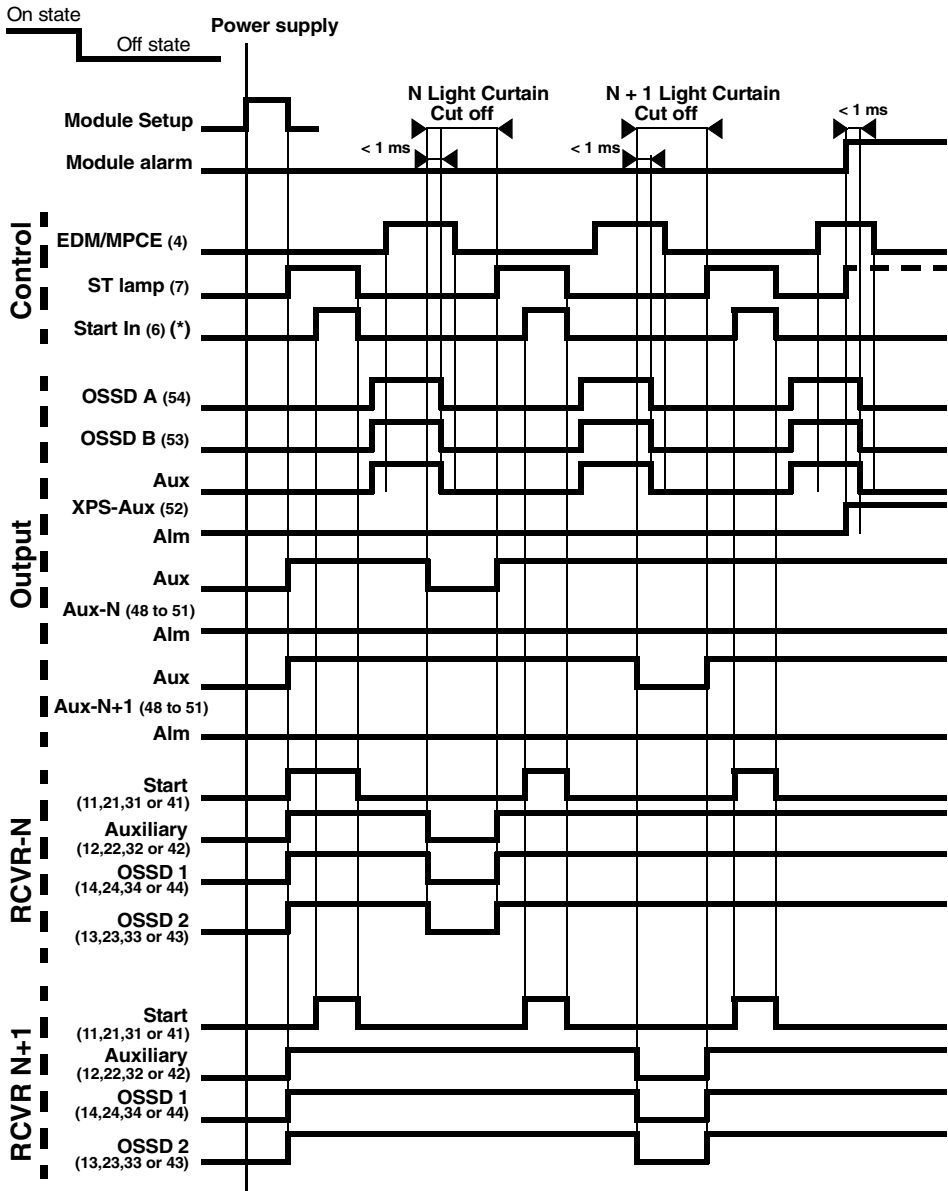

(*) Press "START" button

Operating and wiring instructions

2

At a glance

Overview

This chapter describes the XPSLCD1141 operating and wiring instructions.

What's in this Chapter?

This chapter contains the following topics:

Topic	Page
Safety distance	24
Configuration of XUSL light curtain	25
Wiring connections	28
Setting XPSLCD1141 configuration switches	32
General considerations	34

Safety distance

Safety distance

 WARNING
--

IMPROPER SET UP

Never install a XPSLCD1141 safety device system without regard to the safety distance. If the safety devices connected to the XPSLCD1141 system are mounted too close to the point of operation hazard, the machine may not stop in time to prevent an operator injury.

Failure to follow these instructions can result in death, serious injury, or equipment damage.

A safety device system must be mounted far enough from the machine danger zone so the machine will stop before a hand or other body part reaches the hazardous area. This distance is called the safety distance. It is a calculated number based on a formula. See the user's manual for the XUSLT, XUSLM, XUSLP or XUSLN safety device for safe mounting distance formulas.

Configuration of XUSL light curtain

XUSLT

Configure each XUSLT light curtain as follows:

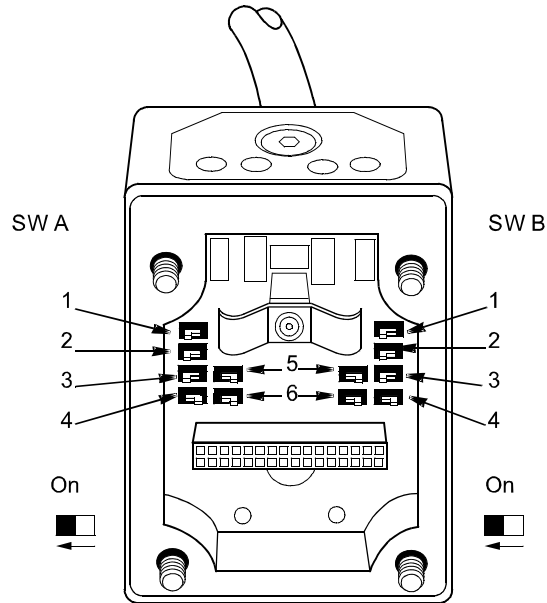

- Set switches SW A and SW B:
 - Switches 1 and 2 to ON (Automatic Start)
 - Switch 3 to ON (EDM/MPCE inactive)
 - Switches 4, 5, and 6 as required (Exact Channel Select/Blanking and Floating Blanking)
 - Connect each light curtain EDM/MPCE wire (pink) to the ground (0 V \equiv)
 - Connect the conductors of the XUSLT transmitter and receiver cables to the XPSLCD1141 terminals connections as described in *Wiring connections*, p. 28.
-

XUSLM

Configure each XUSLM light curtain as follows:

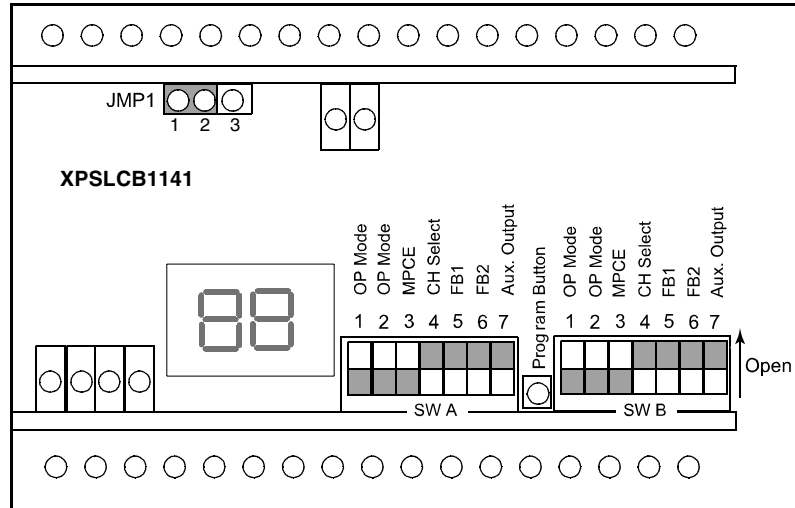

- JMP1 on 1 and 2
- Set switches SWA and SWB:
 - Switches 1 and 2 to OFF (Automatic Start)
 - Switch 3 to ON (EDM/MPCE inactive)
 - Switches 4, 5, and 6 to ON (Exact Channel Select/Blanking and Floating Blanking)
 - Switch 7 as required (ON: Alarm - OFF: copy)
- Connect the conductors of the XUSLM transmitter and receiver cables to the XPSLCD1141 terminals connections as described in *Wiring connections*, p. 28.

XUSLN

No specific setting required but automatic starting light curtain XUSLNG5C*** is recommended.

Connect the conductors of the XUSLN transmitter and receiver cables to the XPSLCD1141 terminals connections as described in *Wiring connections*, p. 28.

XUSLP

Configure each XUSLP light curtain as follows:

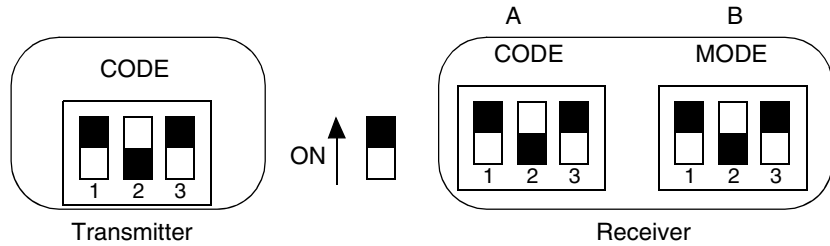

- Set switches SWB of the receiver
 - Set Switches 1 and 2 B to ON (Automatic Start)
 - Set over switches as required
 - Connect the conductors of the XUSLPZ and XUSLPB transmitter and receiver cables to the XPSLCD1141 terminals connections as described in *Wiring connections*, p. 28.
-

Wiring connections

Removable terminal blocks

Removable terminal blocks are divided as follows

- Each light curtain receiver and transmitter is connected to a 10 position terminal block.
 - Power supply inputs, control input & lamp out are connected to a 7 position block.
 - Outputs are connected to a 7-position terminal block.
-

Light curtains

The light curtains must be connected to the XPSLCD1141 using specific terminals:

- one light curtain - connect to RCVR-1 terminals
 - two light curtains – connect to RCVR-1 and RCVR-2 terminals
 - three light curtains – connect to RCVR-1, RCVR-2, and RCVR-3 terminals
 - four light curtains – connect to RCVR-1, RCVR-2, RCVR-3 and RCVR-4 terminals
-

Function Pin Assignment

The connections to the XPSLCD1141 terminal blocks are specified in the table below:

Pin #	Function	Assignment	Pin #	Function	Assignment
1	Power Supply Input	PE	54	Outputs	OSSD A
2		0 V \equiv	53		OSSD B
3		+24 V \equiv	52		XPS-AUX
4	Control Input	EDM/MPCE In	51		AUX-1
5		Return	50		AUX-2
6		Start In	49		AUX-3
7	Lamp Out	Start Lamp Out	48		AUX-4
8	RCVR-1	Drain	47	XMTR-4	Drain
9		0 V \equiv	46		0 V \equiv
10		+24 V \equiv	45		+24 V \equiv
11		Start	44	RCVR-4	OSSD 1
12		Auxilliary	43		OSSD 2
13		OSSD 2	42		Auxilliary
14		OSSD 1	41		Start
15	XMTR-1	+24 V \equiv	40	+24 V \equiv	
16		0 V \equiv	39	0 V \equiv	
17		Drain	38	Drain	
18	RCVR-2	Drain	37	XMTR-3	Drain
19		0 V \equiv	36		0 V \equiv
20		+24 V \equiv	35		+24 V \equiv
21		Start	34	RCVR-3	OSSD 1
22	Auxilliary	33	OSSD 2		
23	OSSD 2	32	Auxilliary		
24	OSSD 1	31	Start		
25	XMTR-2	+24 V \equiv	30	+24 V \equiv	
26		0 V \equiv	29	0 V \equiv	
27		Drain	28	Drain	



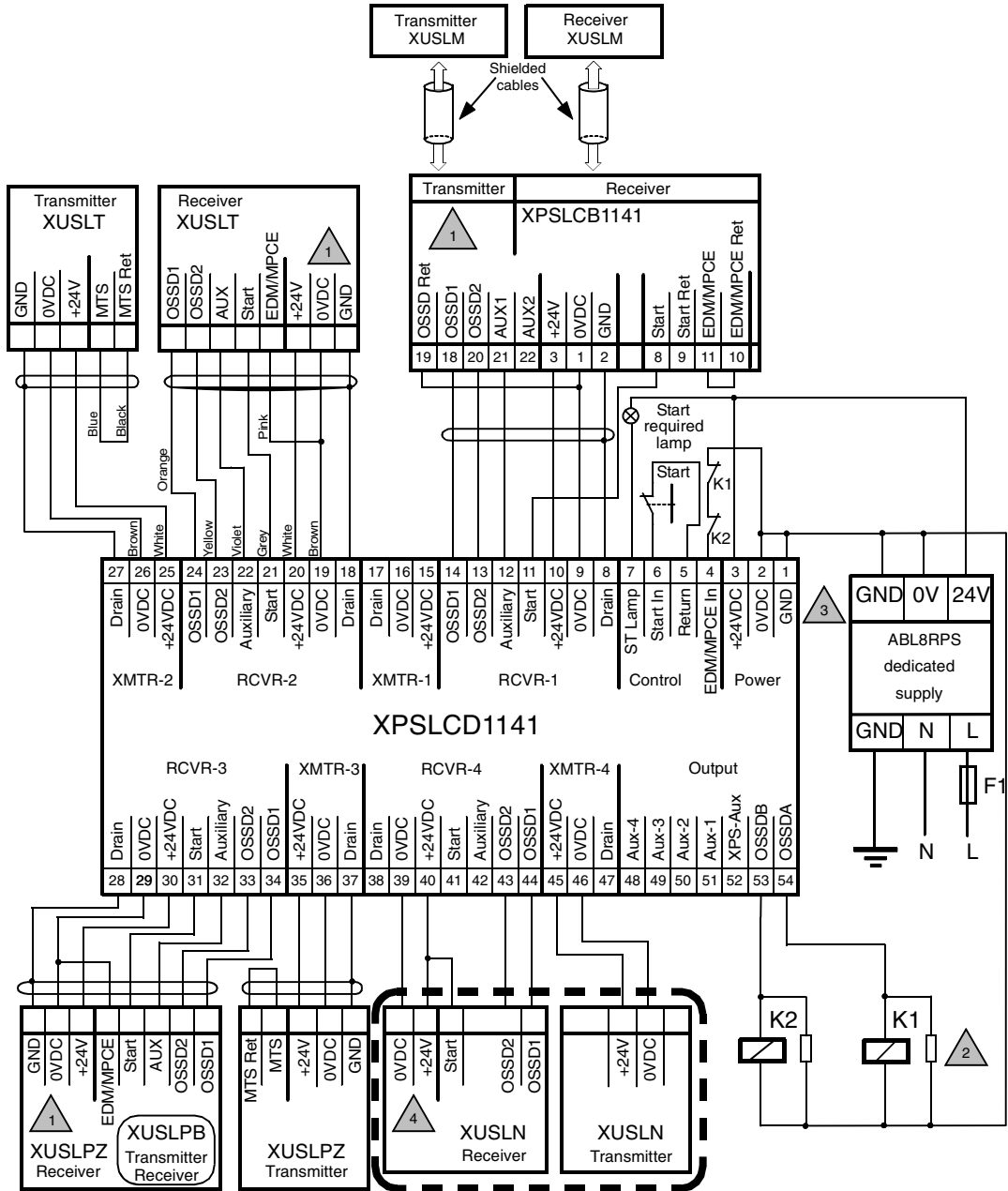

Note:

- The AUX-1 to AUX-4 are the exact AUX or Alarm information from each light curtains
- The +24 V \equiv , 0 V \equiv are internally linked to the Power supply Input.

XPSLCD1141 Wiring Diagram Example with 4 Light Curtains Connected (XUSLT, XUSLM, XUSLP and XUSLN).



Legend

	Light barriers configured with EDM/MPCE not active and automatic start
	The EDM/MPCE coils must be suppressed with the arc suppressors provided in the light barriers' documentation kit
	To choose the dedicated supply, see <i>Power Supply Requirement, p. 15</i>
	When the XPSLCD1141 module is used with a Type 2 rated light curtain or another Type 2 device (XUSLN for example), the overall system protection is reduced to Category 2.

Setting XPSLCD1141 configuration switches

Principle

The setting of the redundant 7-position DIP switches (labeled SWA and SWB) are used on the XPSLCD1141 module to select from the configuration options.

Accessing to configuration switches

Switches to configure the XPSLCD1141 system operating features are located inside the controller. Access is gained by lifting the controller cover tab provided on the label.

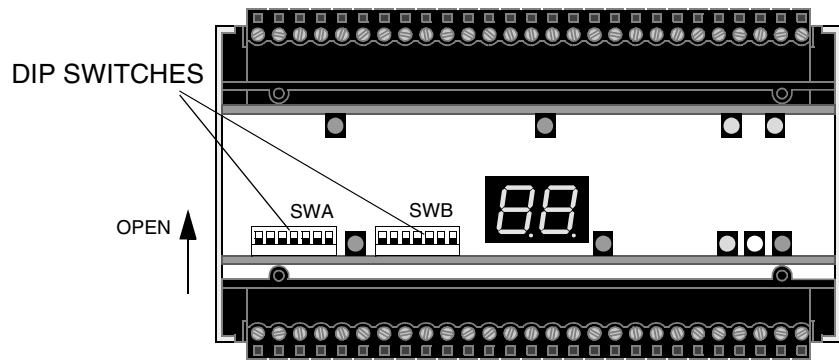

⚠ WARNING

POWER REQUIREMENTS

Disconnect power before removing the controller cover.

Replace the controller cover before re-applying power.

Failure to follow these instructions can result in death, serious injury, or equipment damage.

**Field
configuration
switch settings**

Switch	Function Selection	Description
1 & 2	Operating Mode	Automatic: 1=Closed, 2=Closed Start Interlock: 1=Closed, 2=Open Invalid:1=Open, 2=Closed Start/Restart Interlock:1 =Open,2=Open
3	EDM/MPCE Monitoring	Enabled = Open Disabled = Closed
4 & 5	Number of Light Curtains	One device: 4 = Closed, 5 = Closed Two devices: 4 = Closed, 5 = Open Three devices: 4 =Open, 5 = Closed Four devices: 4 = Open, 5 = Open
6	XPSLCD1141 Auxiliary Output Mode	Follow OSSD indication =Closed Fault Indication =Open
7	XPSLCD1141 Auxiliary Output Type	Current Source (PNP) = Closed Current Sink (NPN) = Open

General considerations

Input power requirements/connections

The XPSLCD1141 system operates directly from 24 V \pm 10%. Power to the XPSLCD1141 must come from a dedicated power supply which must meet the requirements of IEC 60204-1 and IEC 61496-1, Phaseo family type ABL8RPS24030/050/100.

Start required lamp

When connected, the Start Required Lamp indicates when the XPSLCD1141 is waiting for a signal from the start switch. The Start Required Lamp is an option and is not required for operation of the XPSLCD1141.

System common return

The XPSLCD1141 power input return must be connected to the overall system component returns. At the installation site, the power return of the XPSLCD1141 Start switch, EDM/MPCE monitor, Aux PNP, OSSD loads and Aux loads must all be connected in common for proper system operation.

EDM/MPCE monitoring set to disabled

When EDM/MPCE monitoring is set to the inactive position, the EDM/MPCE In terminal block, contact 4, must be connected to the system common return.

Diagnostic display

3

System diagnostic codes

Principle

The controller contains a two-digit diagnostic display, which presents numeric codes indicating both normal operation and system fault status.

Operational codes

The operational codes are described in the table below

Code Displayed	System Status
00	Normal operation
01	Waiting for start input
88	Start operation power-up indication

DIP switch fault codes

The DIP switch fault codes are described in the table below.

Code Displayed	Fault Indicated
21	Wrong operation mode selection
22	Changed during operation
23	DIP switch settings not redundant
24	DIP switch hardware fault
25	Start switch did not toggle
27	More safety devices present than selected

OSSD codes

The OSSD fault codes are described in the table below.

Code Displayed	Fault Indicated
31	OSSD outputs shorted together
32	OSSD A shorted to power
33	OSSD B shorted to power
34	OSSD A shorted to ground
35	OSSD B shorted to ground

EDM/MPCE codes

The EDM/MPCE fault codes are described in the table below.

Code Displayed	Fault Indicated
41	Wrong during operation
42	Wrong before activation
43	Wrong on power on

Internal fault code

The Internal Fault codes are described in the table below.

Code Displayed	Internal Fault
50	Detected fault of XPSLCD1141 internal circuits

Glossary

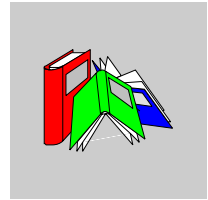

D

Detection Zone The zone within which a specified test piece will be detected by the safety light curtain.

E

EDM/MPCE The electrically powered element that directly controls the normal operation of a machine in such a way that it is the last (in time) to function when machine operation is to be initiated or arrested.

I

Interlock For the XPSLCD1141 to enter this state the unit must be set to either the Start Interlock or Start/Restart Interlock mode. In this state the yellow Interlock LED is on and the red Machine Stop LED is on.

M

Machine Run When the XPSLCD1141 is in this state the two Safety outputs are both active. In this state, the Green Machine Run LED is on, the Red Machine Stop LED is off and the Yellow Interlock LED is off.

Machine Stop When the XPSLCD1141 is in this state the two Safety outputs are both inactive. In this state the Green Machine Run LED is off, the Red Machine Stop LED is on and the Yellow Interlock LED is off.

O

OFF State The state in which the output circuit is interrupted and does not permit current to flow.

ON State The state in which the output circuit is complete and permits the flow of current.

Output Signal Switching Device (OSSD) The component of the safety light curtain connected to the machine control system which, when the light curtain detection zone is interrupted, responds by going to the off state.

R

Response Time The maximum amount of time required for the XPSLCD1141 to recognize a light curtain detection zone interruption and to set its Safety outputs to the Off state.
