

**XBC-D29220C12**  
**XBC-D39220C12**

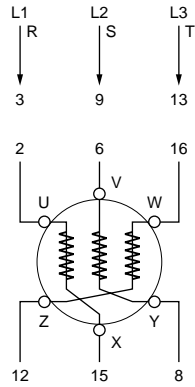

	0	Y	Δ	
1	X	X		1
3	X	X		2
5	X	X		3
7	X	X		4
9	X	X		
11	X	X		
13	X	X		
15	X	X		

**XBC-D29230C12**  
**XBC-D39230C12**

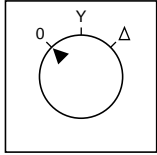
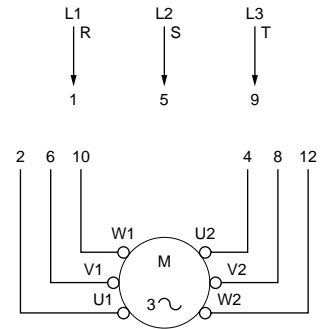
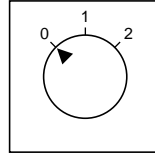

	0	1	2	
1	X			1
3	X			2
5	X			3
7	X			4
9	X			
11	X			
13	X			
15	X			

**XBC-D29222C12**  
**XBC-D39222C12**

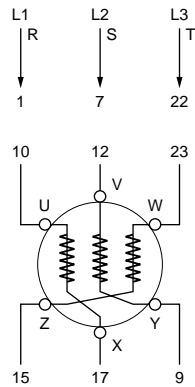
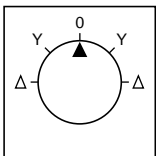

	Δ	Y	0	Y	Δ	
1	X	X		X	X	1
3	X	X		X	X	2
5	X	X		X	X	3
7	X	X		X	X	4
9	X	X		X	X	5
11	X	X		X	X	6
13	X	X		X	X	
15	X	X		X	X	
17	X	X		X	X	
19	X	X		X	X	
21	X	X		X	X	
23	X	X		X	X	

**XBC-D29231C12**  
**XBC-D39231C12**

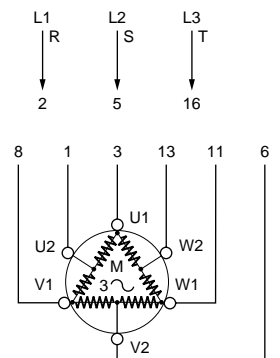
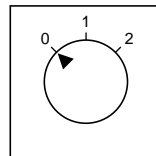

	0	1	2	
1	X			1
3	X			2
5	X			3
7	X			4
9	X			
11	X			
13	X			
15	X			

**XBC-D29224C12**  
**XBC-D39224C12**

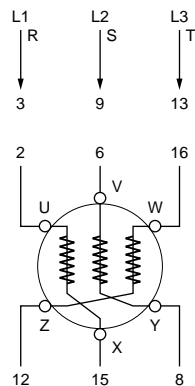
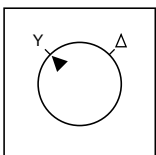

	Y	Δ	
1	X	X	1
3	X	X	2
5	X	X	3
7	X	X	4
9	X	X	
11	X	X	
13	X	X	
15	X	X	

