

SE Current Monitoring Series H221-S6



SPECIFICATIONS

Sensor Power	30 mA (max.)@12-30 VDC
Amperage Range	0-100 A to 0-300 A (scalable)
Sensor Output	4-20 mA
Response Time	2 sec.
Insulation Class	300 VAC RMS, insulated conductors only
Frequency	50/60 Hz
Temperature Range	-15° to 60°C (5° to 140°F)
Humidity Range	10-90% RH non-condensing
Accuracy	±2% FS from 10% to 100% of selected range
Terminal Block Wire Size	0.2 to 2.1 mm ² (24 to 14 AWG)
Terminal Block Torque	0.4 to 0.5 N-m (3.5 to 4.4 in-lb)
Agency Approvals	CE:EN61010-1:2001
Installation Category	Cat. III, pollution degree 2

The Schneider Electric H221-S6 is a current transducer that monitors current (amperage) in the conductor passing through it. The amperage range is field adjustable, with ranges of 0-100 A to 0-300 amperes possible. The device transforms the monitored current into a 4-20 mA DC output, suitable for connection to building controllers or other appropriate data acquisition equipment. The H221-S6 requires a 12-30 VDC external power supply to generate its output.

For CE compliance, conductor shall be insulated according to IEC 61010-1:2010.

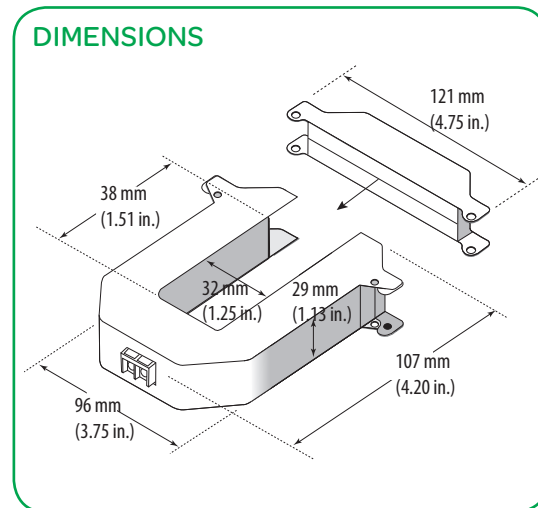

⚡ ⚠ DANGER

HAZARD OF ELECTRIC SHOCK, EXPLOSION, OR ARC FLASH

- Follow safe electrical work practices. See NFPA 70E in the USA, or applicable local codes.
- This equipment must only be installed and serviced by qualified electrical personnel.
- Read, understand and follow the instructions before installing this product.
- Turn off all power supplying equipment before working on or inside the equipment.
- Use a properly rated voltage sensing device to confirm power is off.
- DO NOT DEPEND ON THIS PRODUCT FOR VOLTAGE INDICATION**
- Only install this product on insulated conductors.

Failure to follow these instructions will result in death or serious injury.

A qualified person is one who has skills and knowledge related to the construction and operation of this electrical equipment and the installation, and has received safety training to recognize and avoid the hazards involved. NEC2011 Article 100
No responsibility is assumed by the manufacturer for any consequences arising out of the use of this material.

NOTICE

- This product is not intended for life or safety applications.
- Do not install this product in hazardous or classified locations.
- The installer is responsible for conformance to all applicable codes.
- Mount this product inside a suitable fire and electrical enclosure.



INSTALLATION

Disconnect and lock out power to the enclosure containing the conductor to be monitored.

1. Determine cable routing for the controller connection, allowing the device to reach the monitored conductor.
2. Wire the output connections between the device, the power supply, and the controller (4-20 mA).
3. Snap the device over the conductor.
4. Secure the I-bar to the main body of the transducer with wire ties or some other secure method.
5. Secure the enclosure and reconnect power.
6. Scale the transducer range, then scale the controller software to match the transducer's output (see Scaling section).

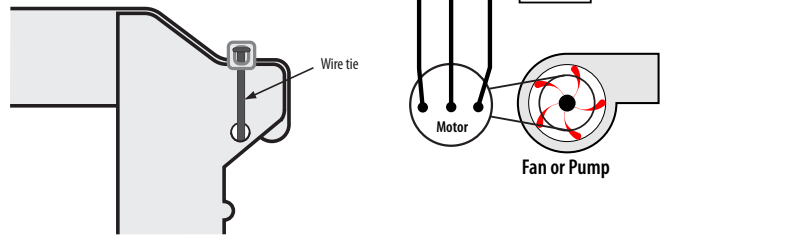

WIRING

Output is not polarity sensitive. Use a 12-30 VDC power supply to operate the transducer.

External Power

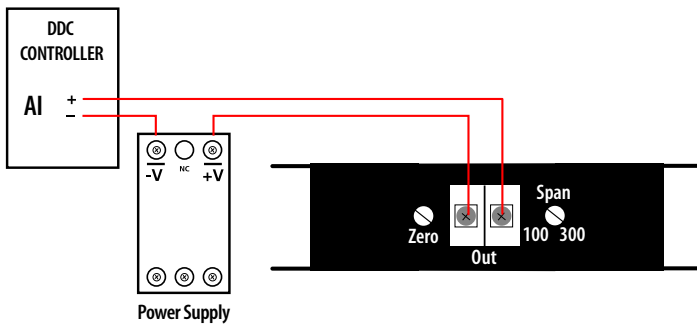

Sinking or Sourcing Panel

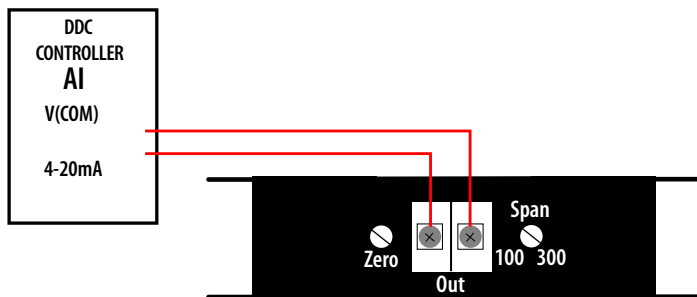

SCALING

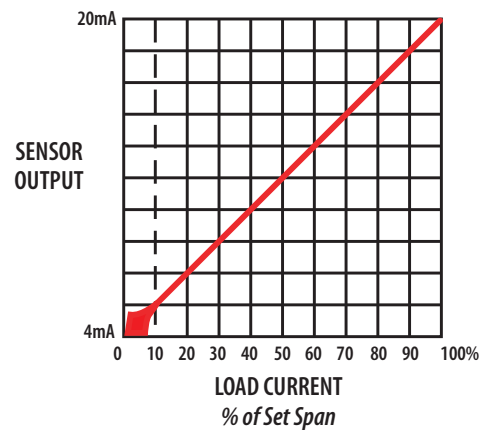

CALIBRATION

1. Set Zero.

Apply power to the sensor with no load on the conductor. Turn the zero setpoint screw until the controller reads 4 mA. The setpoint screw has no stops.

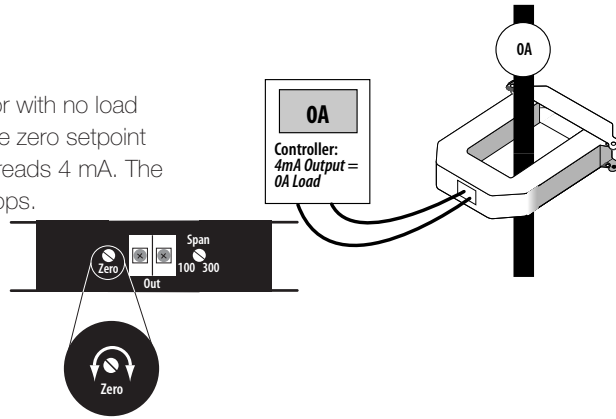

2. Calculate the maximum and target readings.

A. Determine the maximum current to be measured.

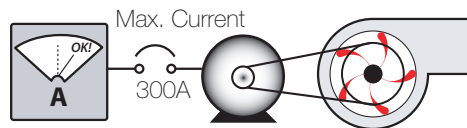

B. Find the actual current using an external measurement device.

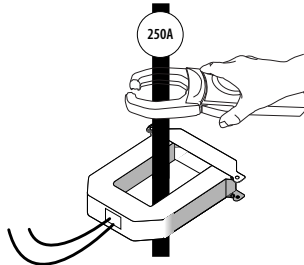

C. Calculate the target output:
If A = the max. current, and B = the reading from the amp clamp, then:

$$\text{target output} = 16 \text{ mA} \times \frac{B}{A} + 4 \text{ mA}$$

$$\text{e.g. target output} = 16 \text{ mA} \times \frac{250}{300} + 4 \text{ mA} = 17.33 \text{ mA}$$

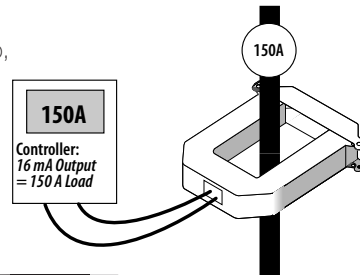

3. Set span

Turn the span setpoint screw until the controller reading equals the target output.

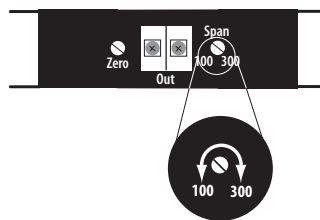

TROUBLESHOOTING

PROBLEM	SOLUTION
No Reading at Controller	<ul style="list-style-type: none"> • Confirm that a 12-30 VDC power supply is in series with the sensor output terminals and the controller analog input terminals. • Assure that sensor core mating surfaces are clean and that the core clamp is completely closed.

PRODUCT INFORMATION

Ordering Code	Model Number	Description
324-0210-000	H221-S6	I-Xdcr,0-300AAC Adj. : 4-20mA