



This document is the exclusive property of Schneider Electric Industries S.A.S and shall not be used, copied or communicated to third parties without its prior authorization.
 Ce document est la propriété exclusive de Schneider Electric Industries SAS et ne doit pas être utilisé, copié ou communiqué à des tiers sans son autorisation préalable.

COV_01

00	F.PIMENTA 16/01/2018	D.AYNIÉ 16/01/2018	JP.BURTHIER 16/01/2018	Création First issue
Version N° Revision N°	Dessiné par Drawn by	Vérifié par Checked by	Approuvé par Approved by	Modification Change
Client Customer	Schneider Electric			Numéro AMT Number AMT 672803-000
Référence projet client Customer project reference				Sb =01
Projet Project	FBX-Sb-AB3			AB3 AC/DC
Seuls les documents remis en confirmation de commande nous engagent pour exécution conforme. Only documents submitted as order confirmation may be considered as binding for manufacturing purposes.				
Type de document Document type Schéma type Circuit diagram type				AMT
				Version N° Revision N° 00
Gamme de cellule Panel range	FBX	Format Format A3	Numéro de dessin Drawing number 672803-000	Numéro de page Page number 001 / 016

1		2		3		4		5		6		7		8				
Folio Sheet	Version N° Revision N°	Schéma type Circuit diagram type	Description Description		Cellule Panel	Rame Section	Nom de la page Sheet name											
001	01	Page de garde Cover sheet					COV_01											
002	01	Sommaire Content sheet					CON_01											
003	00	Liste des révisions List of revisions					REV_01											
004	00	Circuit de puissance Power circuit	Sb AB3 AC/DC		01101	1	+101 DRW_01											
005	00	Distribution polarités Polarities	Sb AB3 AC/DC		01101	1	+101 DRW_02											
006	00	Contrôle Commande Control Command	Sb AB3 AC/DC		01101	1	+101 DRW_03											
007	00	Contrôle Commande Control Command	Sb AB3 AC/DC		01101	1	+101 DRW_04											
008	00	Contrôle Commande Control Command	Sb AB3 AC/DC		01101	1	+101 DRW_05											
009	00	Contrôle Commande Control Command	Sb AB3 AC/DC		01101	1	+101 DRW_06											
010	00	Signalisation Signalling	Sb AB3 AC/DC		01101	1	+101 DRW_07											
011	00	Signalisation Signalling	Sb AB3 AC/DC		01101	1	+101 DRW_08											
012	00	Plan de borniers -X15 Terminal sheet -X15	Sb AB3 AC/DC		01101	1	+101 TER_00											
013	00	Plan de borniers -X1 Terminal sheet -X1	Sb AB3 AC/DC		01101	1	+101 TER_01											
014	00	Plan de borniers -X1 Terminal sheet -X1	Sb AB3 AC/DC		01101	1	+101 TER_02											
015	00	Plan de borniers -X2 Terminal sheet -X2	Sb AB3 AC/DC		01101	1	+101 TER_03											
016	01	Nomenclature Bill of material	Sb AB3 AC/DC		01101	1	+101 BOM_01											
<p>This document is the exclusive property of Schneider Electric Industries S.A. S and shall not be used, copied or communicated to third parties without its prior authorization. Ce document est la propriété exclusive de Schneider Electric Industries SAS et ne doit pas être utilisé, copié ou communiqué à des tiers sans son autorisation préalable.</p>																		
Format Format	Dessiné par Drawn by	Vérifié par Checked by	Approuvé par Approved by	Numéro AMT Number AMT	672803-000	Sb	Gamme de cellule Panel range	FBX	Projet Project	FBX-Sb-AB3	Version N° Revision N°							
A3				Sommaire Content sheet				AMT	Numéro de dessin Drawing number	672803-000	Numéro de page Page number							
									Emplacement Location	=01	Nom de la page Sheet name	CON_01					002 / 016	

1	2		3		4	5		6		7		8		
Révision Revision	Date Date	Descriptif de la modification Description of the modification					Version Version	Date Date	Descriptif de la modification Description of the modification					
00	16/01/2018	Création First issue												
Format Format	Dessiné par Drawn by	Vérifié par Checked by	Approuvé par Approved by	Numéro AMT Number AMT	672803-000	Sb	Gamme de cellule Panel range	FBX	Projet Project	FBX-Sb-AB3	Version N° Revision N°	00		
A3	F.PIMENTA	D.AYNIE	JP.BURTHIER	Liste des révisions List of revisions				AMT	Numéro de dessin Drawing number	672803-000	Nom de la page Sheet name	REV_01	Numéro de page Page number	003 / 016
	16/01/2018	16/01/2018	16/01/2018						Emplacement Location	=01				

This document is the exclusive property of Schneider Electric Industries S.A. S and shall not be used, copied or communicated to third parties without its prior authorization.
 Ce document est la propriété exclusive de Schneider Electric Industries SAS et ne doit pas être utilisé, copié ou communiqué à des tiers sans son autorisation préalable.

A
B
C
D
E
F

A
B
C
D
E
F

This document is the exclusive property of Schneider Electric Industries S.A. S and shall not be used, copied or communicated to third parties without its prior authorization.
 Ce document est la propriété exclusive de Schneider Electric Industries SAS et ne doit pas être utilisé, copié ou communiqué à des tiers sans son autorisation préalable.

Circuit de puissance
 Power circuit

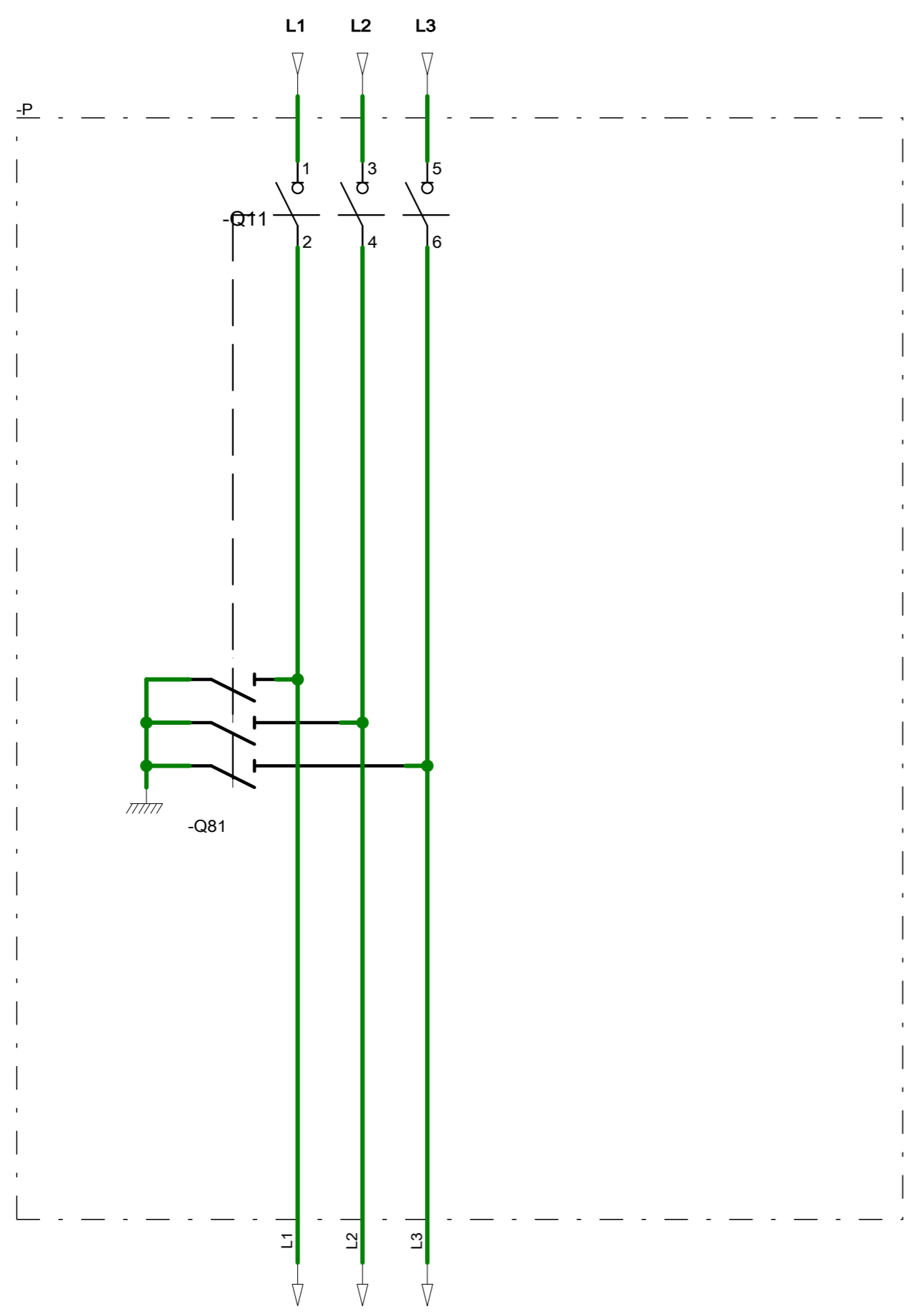

Format Format	Dessiné par Drawn by	Vérifié par Checked by	Approuvé par Approved by	Numéro AMT Number AMT	672803-000	-	-	Sb AB3 AC/DC	Projet Project	FBX-Sb-AB3	Version N° Revision N°	00		
A3	F.PIMENTA	D.AYNIÉ	JP.BURTHIER	Circuit de puissance Power circuit 01101			Schneider Electric	AMT	Numéro de dessin Drawing number	672803-000	Schéma type Circuit diagram type	Sch1001	Numéro de page Page number	004 / 016
	16/01/2018	16/01/2018	16/01/2018						Emplacement Location	=01 +101	Nom de la page Sheet name	DRW_01		

This document is the exclusive property of Schneider Electric Industries S.A. S and shall not be used, copied or communicated to third parties without its prior authorization.
Ce document est la propriété exclusive de Schneider Electric Industries SAS et ne doit pas être utilisé, copié ou communiqué à des tiers sans son autorisation préalable.

ALIMENTATION AUXILIAIRE
AUXILIARY SUPPLY

Convertisseur x AC-DC / 24VDC
Converter x AC-DC / 24VDC

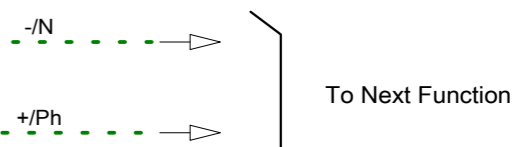
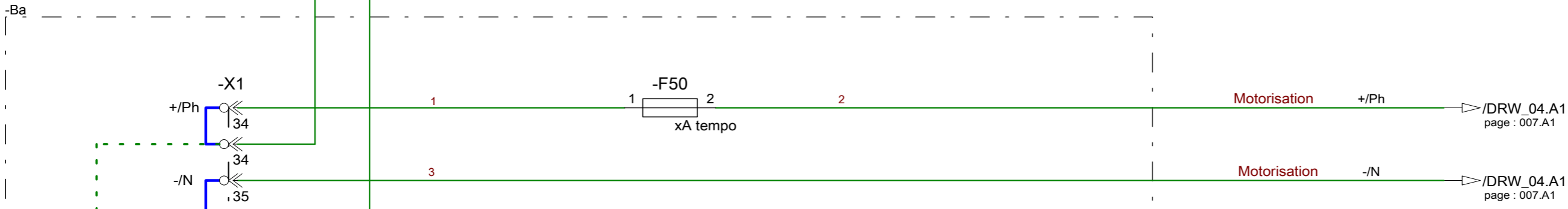
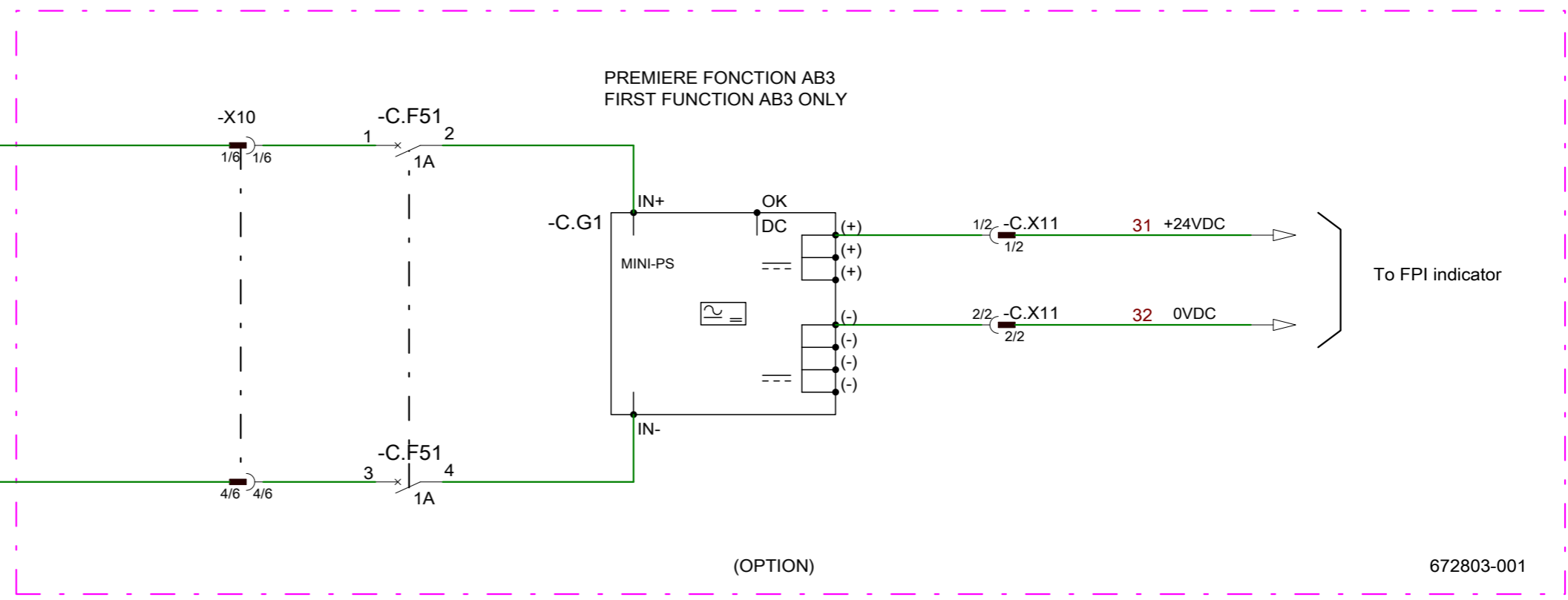

Format Format	Dessiné par Drawn by	Vérifié par Checked by	Approuvé par Approved by	Numéro AMT Number AMT	672803-000	-	-	Sb AB3 AC/DC	Projet Project	FBX-Sb-AB3	Version N° Revision N°	00	
A3	F.PIMENTA	D.AYNIÉ	JP.BURTHIER	Distribution polarités Polarities 01101				AMT	Numéro de dessin Drawing number	672803-000	Schéma type Circuit diagram type	Sch1001	
	16/01/2018	16/01/2018	16/01/2018					Emplacement Location	=01 +101	Nom de la page Sheet name	DRW_02	Numéro de page Page number	005 / 016

This document is the exclusive property of Schneider Electric Industries S.A.S and shall not be used, copied or communicated to third parties without its prior authorization.
Ce document est la propriété exclusive de Schneider Electric Industries SAS et ne doit pas être utilisé, copié ou communiqué à des tiers sans son autorisation préalable.

LOCAL
LOCAL

DISTANCE
REMOTE

PREMIERE FONCTION AB3
FIRST FUNCTION AB3 ONLY

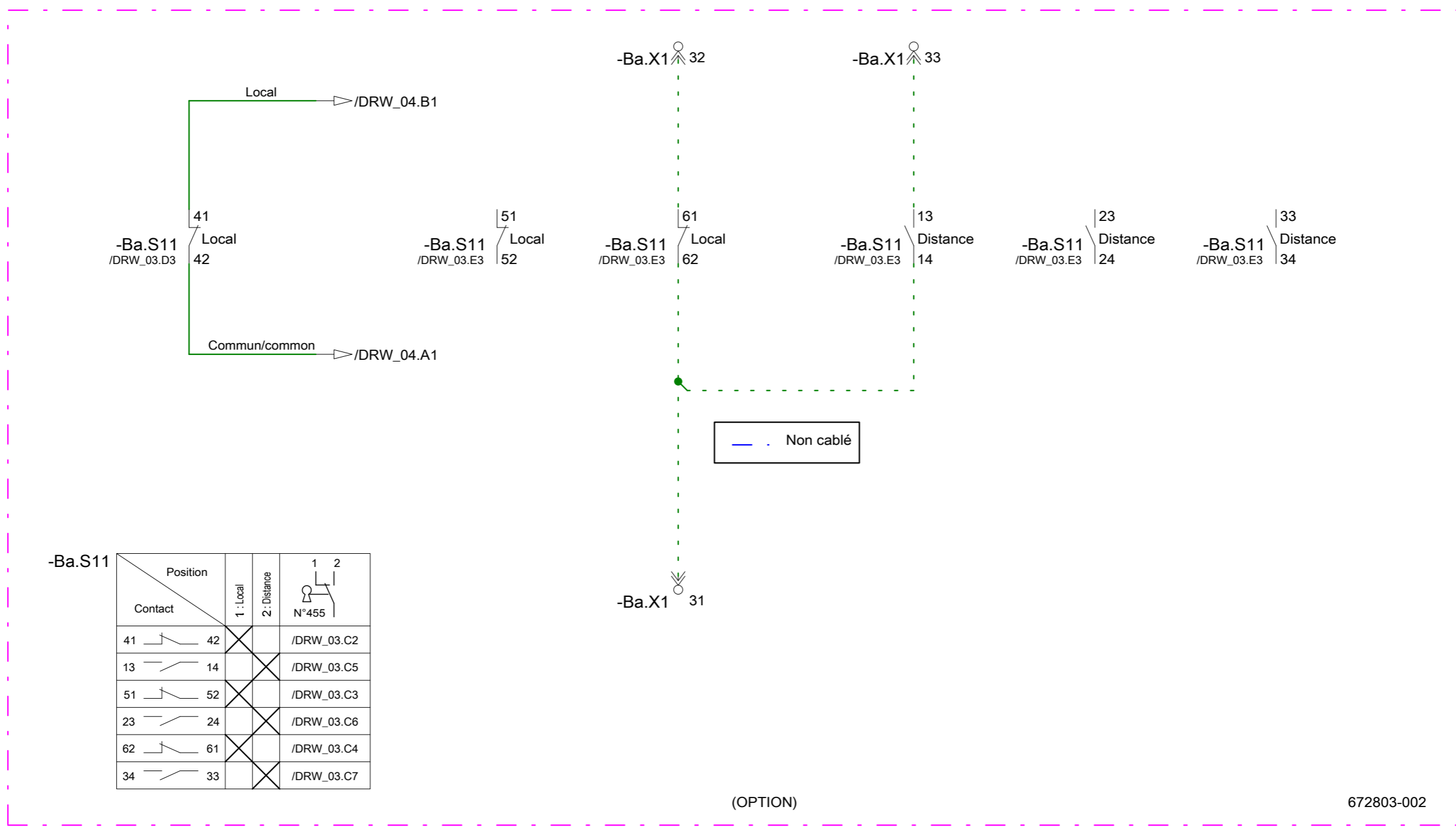

-Ba.S11

Contact	Position		N°455
	1: Local	2: Distance	
41 — 42	<input checked="" type="checkbox"/>	<input checked="" type="checkbox"/>	/DRW_03.C2
13 — 14	<input checked="" type="checkbox"/>	<input checked="" type="checkbox"/>	/DRW_03.C5
51 — 52	<input checked="" type="checkbox"/>	<input checked="" type="checkbox"/>	/DRW_03.C3
23 — 24	<input checked="" type="checkbox"/>	<input checked="" type="checkbox"/>	/DRW_03.C6
62 — 61	<input checked="" type="checkbox"/>	<input checked="" type="checkbox"/>	/DRW_03.C4
34 — 33	<input checked="" type="checkbox"/>	<input checked="" type="checkbox"/>	/DRW_03.C7

— Non câblé

(OPTION)

672803-002

Format Format	Dessiné par Drawn by	Vérifié par Checked by	Approuvé par Approved by	Numéro AMT Number AMT	672803-000	-	-	Sb AB3 AC/DC	Projet Project	FBX-Sb-AB3	Version N° Revision N°	00	
A3	F.PIMENTA	D.AYNIÉ	JP.BURTHIER	Contrôle Commande Control Command 01101				AMT	Numéro de dessin Drawing number	672803-000	Schéma type Circuit diagram type	Sch1001	
	16/01/2018	16/01/2018	16/01/2018					Emplacement Location	=01 +101	Nom de la page Sheet name	DRW_03	Numéro de page Page number	006 / 016

/DRW_02.E7
page : 005.E7
-N

/DRW_02.D7
page : 005.D7
+/Ph

/DRW_03.C3
page : 006.C3
Commun/common

/DRW_03.B3
page : 006.B3
Local

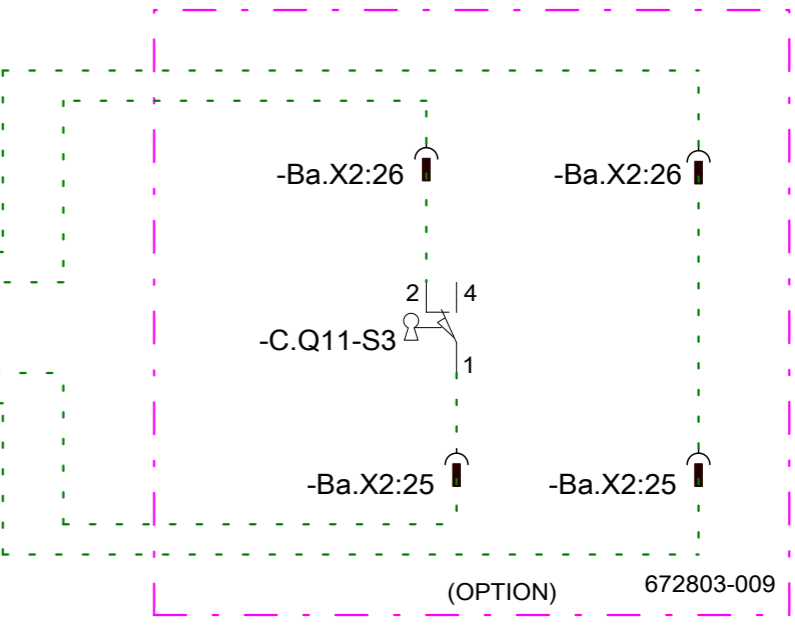
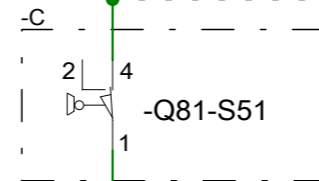
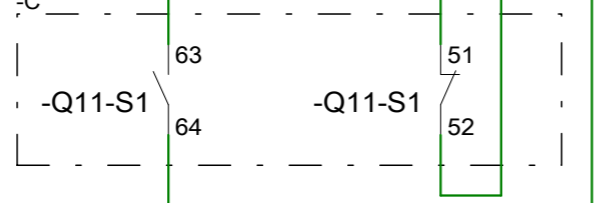
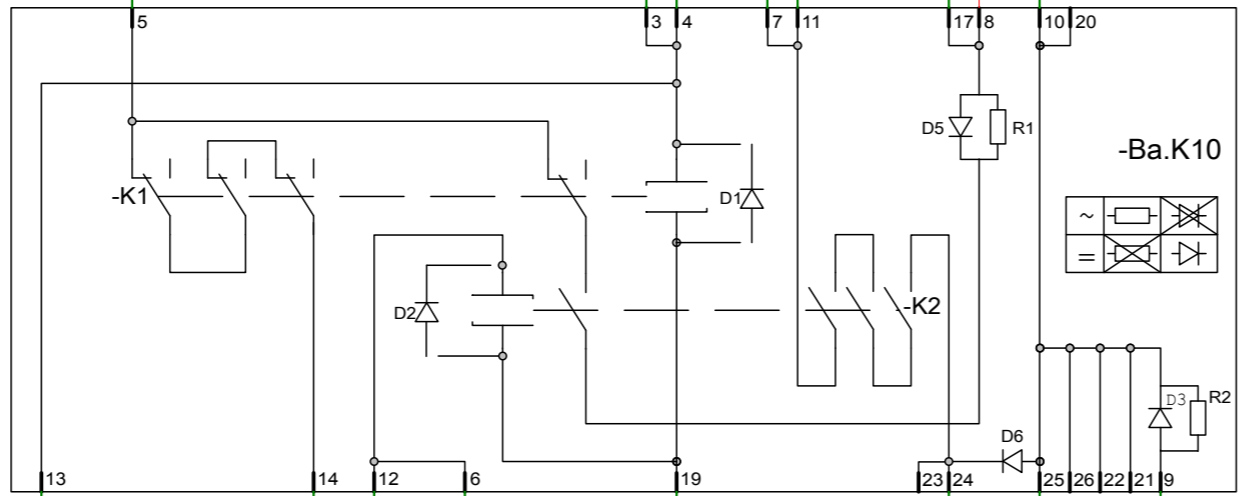
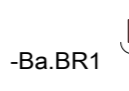
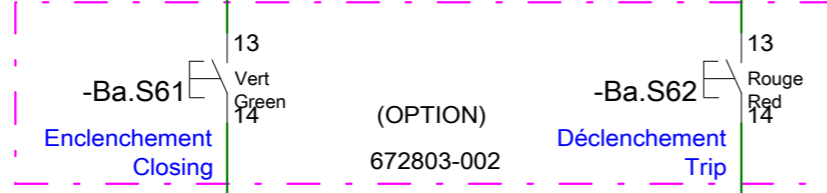

OFF → /DRW_05.D1
page : 008.D1

ON → /DRW_05.D1
page : 008.D1

-/Ph → /DRW_05.A3
page : 008.A3

-N → /DRW_06.E1
page : 009.E1

+/Ph → /DRW_06.B1
page : 009.B1

-Ba.X20
1
Local → to next function

This document is the exclusive property of Schneider Electric Industries S.A. S and shall not be used, copied or communicated to third parties without its prior authorization.
Ce document est la propriété exclusive de Schneider Electric Industries SAS et ne doit pas être utilisé, copié ou communiqué à des tiers sans son autorisation préalable.

Format Format	Dessiné par Drawn by	Vérifié par Checked by	Approuvé par Approved by	Numéro AMT Number AMT	672803-000	-	Sb AB3 AC/DC	Projet Project	FBX-Sb-AB3	Version N° Revision N°	00
A3	F.PIMENTA	D.AYNIÉ	JP.BURTHIER		Contrôle Commande Control Command		AMT	Numéro de dessin Drawing number	Schéma type Circuit diagram type	Sch1001	Numéro de page Page number
	16/01/2018	16/01/2018	16/01/2018		01101			Emplacement Location	Nom de la page Sheet name	DRW_04	007 / 016
								=01 +101			



This document is the exclusive property of Schneider Electric Industries S.A. S and shall not be used, copied or communicated to third parties without its prior authorization.
Ce document est la propriété exclusive de Schneider Electric Industries SAS et ne doit pas être utilisé, copié ou communiqué à des tiers sans son autorisation préalable.

ENCLENCHEMENT EXTERIEUR / DECLENCHEMENT DISTANCE
EXTERNAL CLOSING / REMOTE TRIPPING

ENCLENCHEMENT EXTERIEUR / DECLENCHEMENT DISTANCE
EXTERNAL CLOSING / REMOTE TRIPPING
par relais de découplage 220 VDC / with LV relays 220 VDC

ENCLENCHEMENT EXTERIEUR / DECLENCHEMENT DISTANCE
EXTERNAL CLOSING / REMOTE TRIPPING
par relais de découplage autres tensions / with LV relays for other voltage

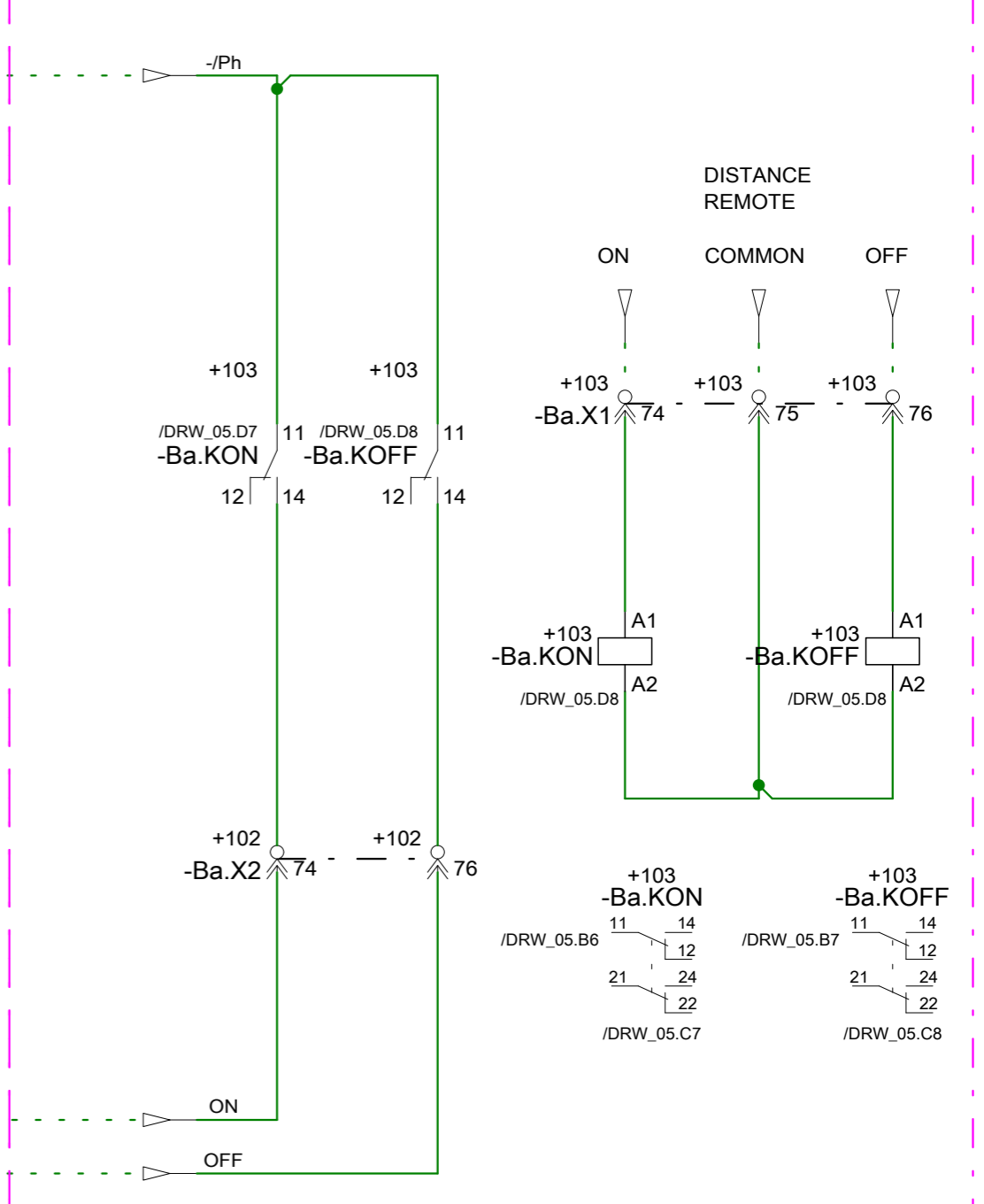
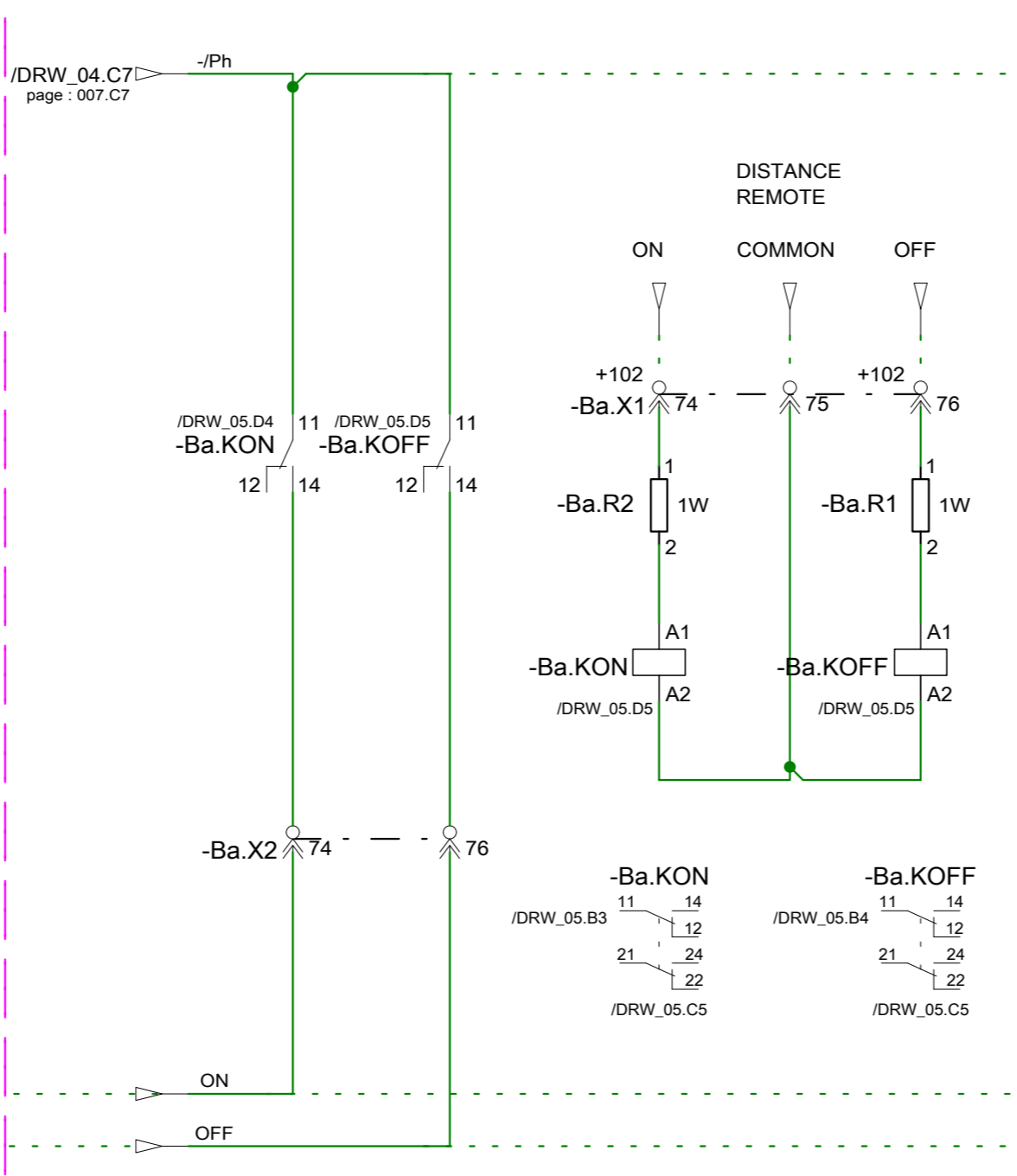
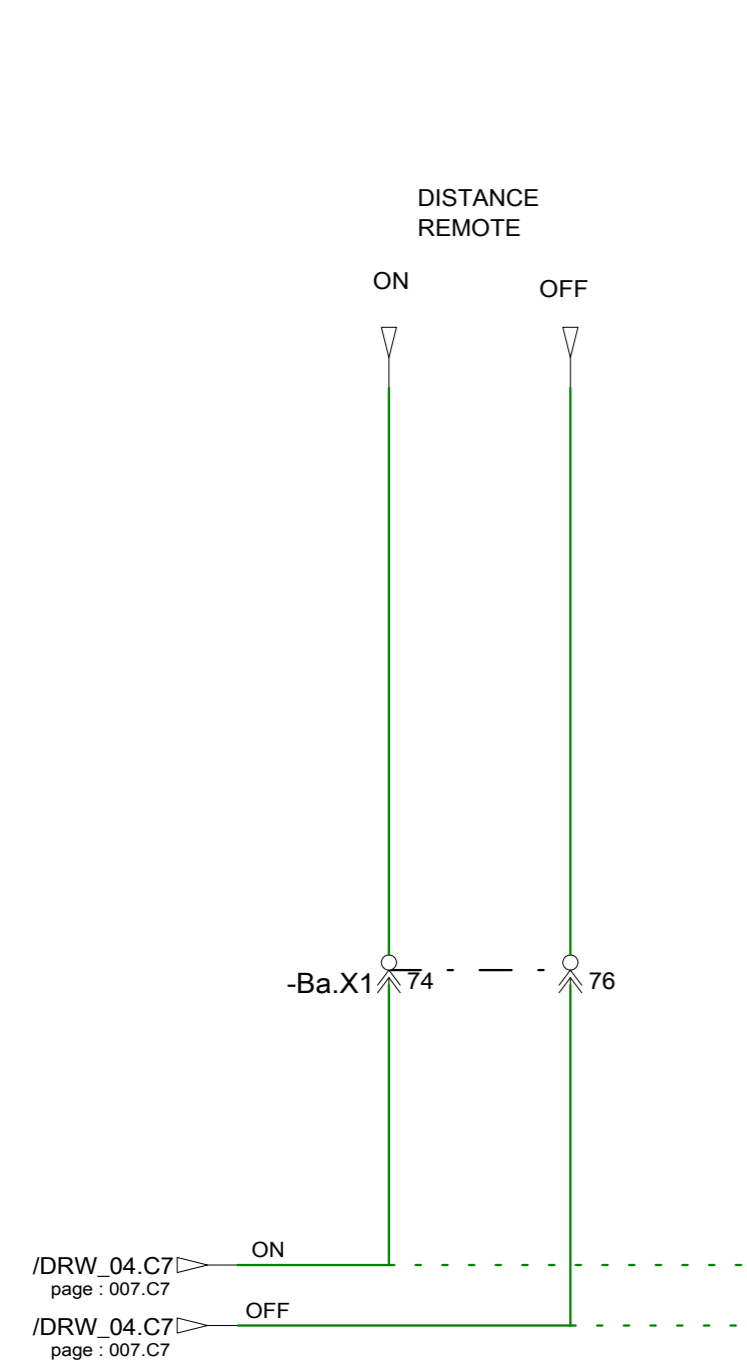

672803-016

672803-017

672803-018

Format Format	Dessiné par Drawn by	Vérifié par Checked by	Approuvé par Approved by	Numéro AMT Number AMT	672803-000	-	Sb AB3 AC/DC	Projet Project	FBX-Sb-AB3	Version N° Revision N°	00
A3	F.PIMENTA	D.AYNIÉ	JP.BURTHIER	Contrôle Commande Control Command 01101				Numéro de dessin Drawing number	Schéma type Circuit diagram type	Numéro de page Page number	
	16/01/2018	16/01/2018	16/01/2018				AMT	672803-000	Sch1001	008 / 016	
								Emplacement Location	Nom de la page Sheet name		
								=01 +101	DRW_05		

This document is the exclusive property of Schneider Electric Industries S.A. S and shall not be used, copied or communicated to third parties without its prior authorization.
 Ce document est la propriété exclusive de Schneider Electric Industries SAS et ne doit pas être utilisé, copié ou communiqué à des tiers sans son autorisation préalable.

REARME MOTEUR (Alimentation AC)
 RESETTING MOTOR (Supply AC)

REARME MOTEUR (Alimentation DC)
 RESETTING MOTOR (Supply DC)

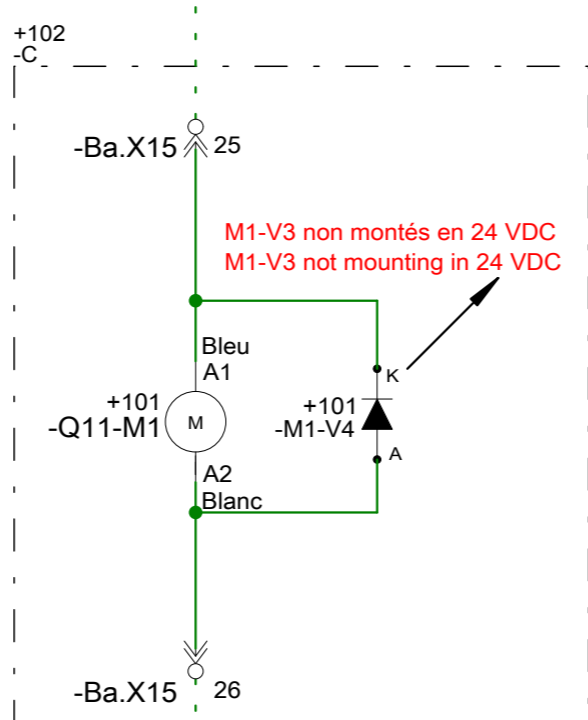
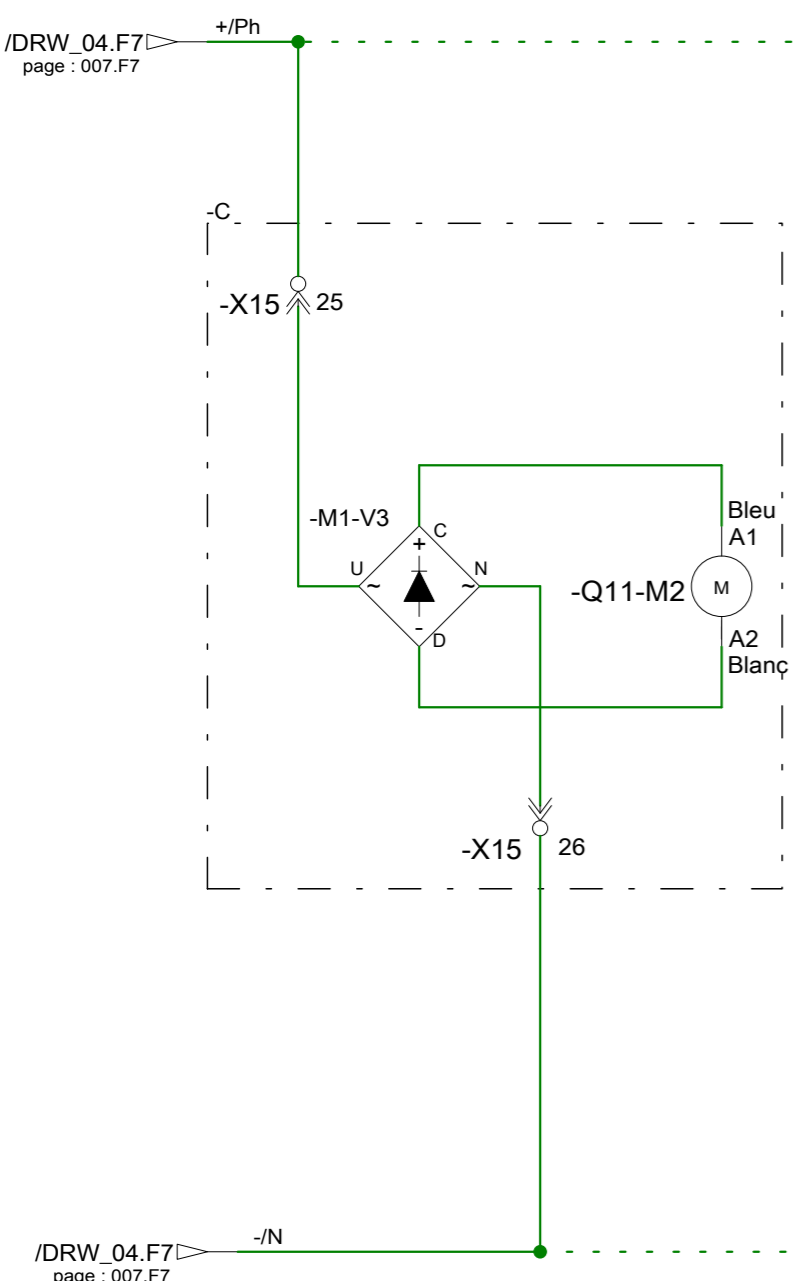

(AC) 672803-007

(DC) 672803-008

Format Format	Dessiné par Drawn by	Vérifié par Checked by	Approuvé par Approved by	Numéro AMT Number AMT	672803-000	-	-	Sb AB3 AC/DC	Projet Project	FBX-Sb-AB3	Version N° Revision N°	00
A3	F.PIMENTA	D.AYNIE	JP.BURTHIER	Contrôle Commande Control Command 01101		Schneider Electric		AMT	Numéro de dessin Drawing number	672803-000	Schéma type Circuit diagram type	Sch1001
	16/01/2018	16/01/2018	16/01/2018						Emplacement Location	=01 +101	Nom de la page Sheet name	DRW_06
												Numéro de page Page number
												009 / 016

This document is the exclusive property of Schneider Electric Industries S.A. S and shall not be used, copied or communicated to third parties without its prior authorization.
Ce document est la propriété exclusive de Schneider Electric Industries SAS et ne doit pas être utilisé, copié ou communiqué à des tiers sans son autorisation préalable.

1 2 3
POSITION INTERRUPTEUR SECTIONNEUR MT
MV LOAD BREAK AND ISOLATOR SWITCH POSITION

4 5 6 7 8
POSITION SECTIONNEUR DE TERRE
EARTHING SWITCH POSITION

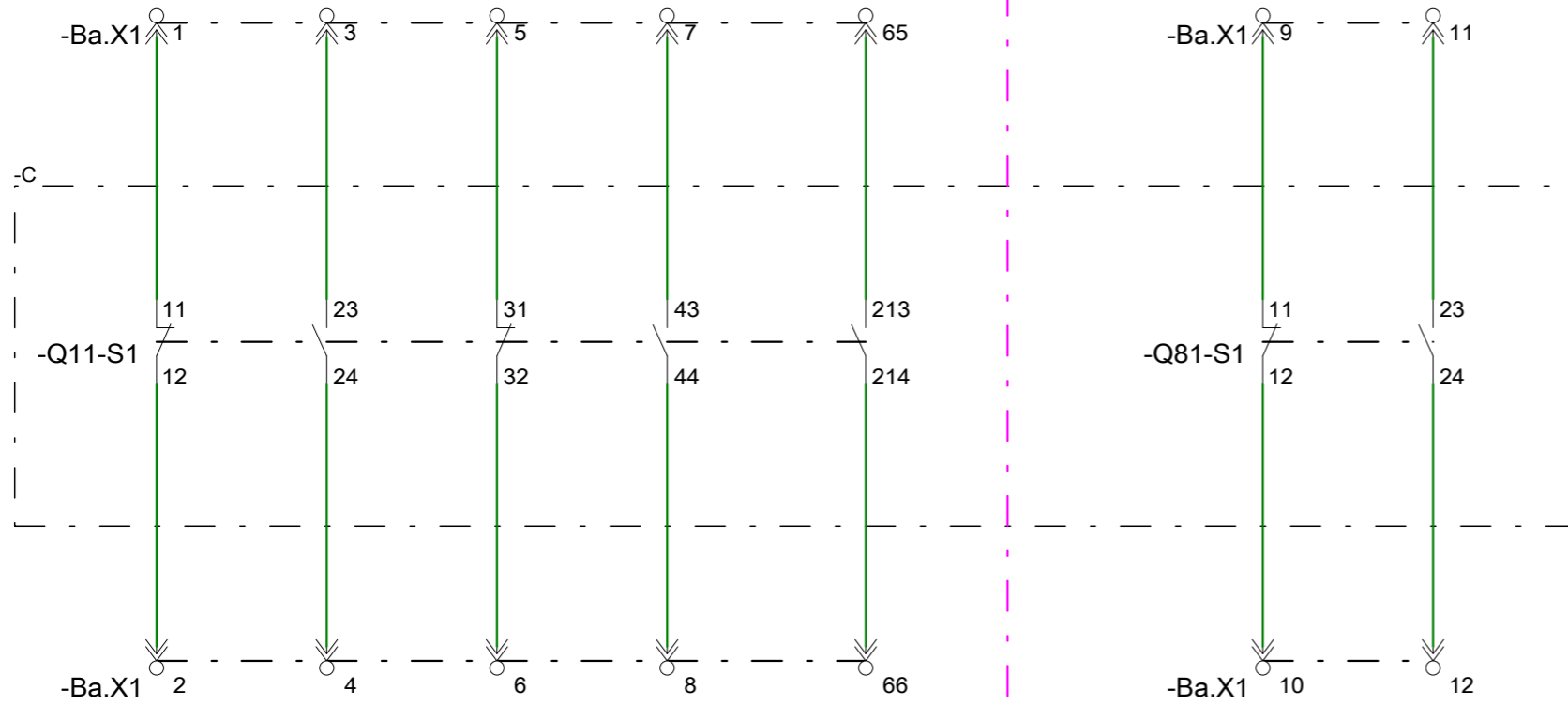

(OPTION) 672803-005

672800-014

672800-015

Format Format	Dessiné par Drawn by	Vérifié par Checked by	Approuvé par Approved by	Numéro AMT Number AMT	672803-000	-	-	Sb AB3 AC/DC	Projet Project	FBX-Sb-AB3	Version N° Revision N°	00
A3	F.PIMENTA	D.AYNIÉ	JP.BURTHIER	Signalisation Signalling 01101	Schneider Electric	AMT	672803-000	Numéro de dessin Drawing number	Schéma type Circuit diagram type	Sch1001	Numéro de page Page number	010 / 016
16/01/2018	16/01/2018	16/01/2018	Emplacement Location					=01 +101	Nom de la page Sheet name	DRW_07		

This document is the exclusive property of Schneider Electric Industries S.A. S and shall not be used, copied or communicated to third parties without its prior authorization.
Ce document est la propriété exclusive de Schneider Electric Industries SAS et ne doit pas être utilisé, copié ou communiqué à des tiers sans son autorisation préalable.

1
2
3
4
5
6
7
8

DEFAUT SF6
SF6 FAILURE

DEFAUT SF6
SF6 FAILURE

Communication

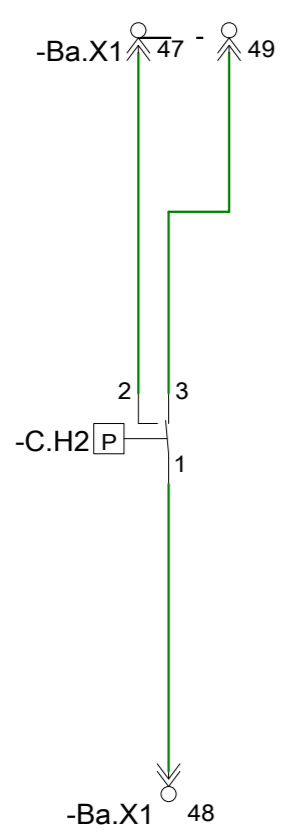

(OPTION) 672803-014

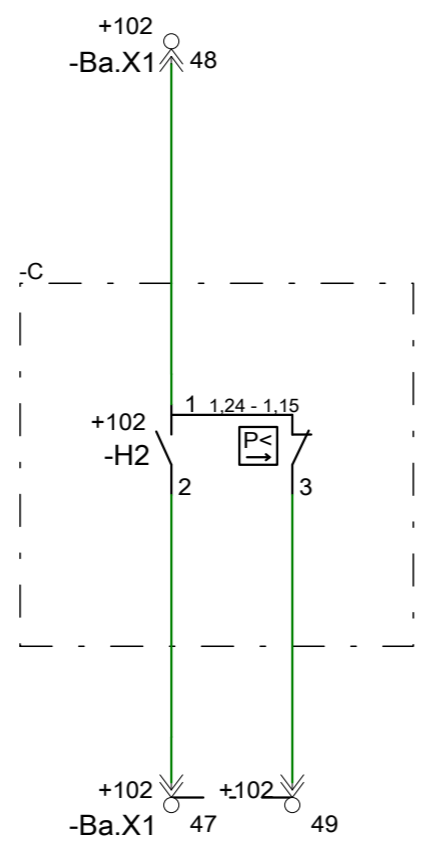

(OPTION) 672803-015

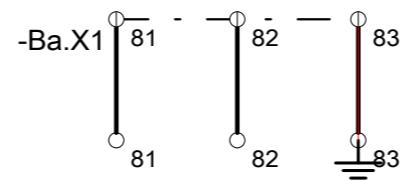

Format Format	Dessiné par Drawn by	Vérifié par Checked by	Approuvé par Approved by	Numéro AMT Number AMT	672803-000	-	-	Sb AB3 AC/DC	Projet Project	FBX-Sb-AB3	Version N° Revision N°	00
A3	F.PIMENTA	D.AYNIÉ	JP.BURTHIER	Signalisation Signalling 01101			Schneider Electric	AMT	Numéro de dessin Drawing number	672803-000	Schéma type Circuit diagram type	Sch1001
	16/01/2018	16/01/2018	16/01/2018						Emplacement Location	=01 +101	Nom de la page Sheet name	DRW_08

This document is the exclusive property of Schneider Electric Industries S.A.S and shall not be used, copied or communicated to third parties without its prior authorization.
 Ce document est la propriété exclusive de Schneider Electric Industries SAS et ne doit pas être utilisé, copié ou communiqué à des tiers sans son autorisation préalable.

Folio **-C.X15** Signal Fonction

/DRW_06.B1	25	+/Ph	Q11-M1 : Motorisation
/DRW_06.D2	26	-/N	Q11-M1 : Motorization Q11-M1 : Motorisation Q11-M1 : Motorization

Format Format	Dessiné par Drawn by	Vérifié par Checked by	Approuvé par Approved by	Numéro AMT Number AMT	672803-000	-	-	Sb AB3 AC/DC	Projet Project	FBX-Sb-AB3	Version N° Revision N°	00	
A3	F.PIMENTA	D.AYNIE	JP.BURTHIER	Plan de borniers -X15 Terminal sheet -X15 01101				AMT	Numéro de dessin Drawing number	672803-000	Schéma type Circuit diagram type	Sch1001	Numéro de page Page number
16/01/2018	16/01/2018	16/01/2018	Emplacement Location						=01 +101	Nom de la page Sheet name	TER_00	012 / 016	

This document is the exclusive property of Schneider Electric Industries S.A.S and shall not be used, copied or communicated to third parties without its prior authorization.
Ce document est la propriété exclusive de Schneider Electric Industries SAS et ne doit pas être utilisé, copié ou communiqué à des tiers sans son autorisation préalable.

Folio	-Ba.X1	Signal	Fonction
/DRW_02.D2	34	+/Ph	Distribution polarités : +/Ph; Polarities : +/Ph;
/DRW_02.E2	34	+/Ph	Distribution polarités : +/Ph; Polarities : +/Ph;
/DRW_02.E2	35	-/N	Distribution polarités : -/N Polarities: -/N
/DRW_02.E2	35	-/N	Distribution polarités : -/N Polarities: -/N
	36		RESERVE
	37		SPARE
	38		RESERVE
	38		SPARE
	21		RESERVE
	22		SPARE
	23		RESERVE
	24		SPARE
/DRW_07.C3	65		Q11-S1 213-214 : Position interrupteur MT
/DRW_07.D3	66	5	Q11-S1 213-214 : MV load break switch position
/DRW_05.C2	74	ON	Enclenchement extérieur External closing
/DRW_05.B5	75		Commande extérieure : Commun Remonte Command : Common
/DRW_05.C2	76	OFF	Déclenchement extérieur External tripping
	77		RESERVE
	41		SPARE
	42		RESERVE
	42		SPARE
	43		RESERVE
	43		SPARE
	44		RESERVE
	44		SPARE
	45		RESERVE
	45		SPARE
	46		RESERVE
	46		SPARE
/DRW_08.B1	47		Défaut pression Pressure fault
/DRW_08.D1	48		H2 : Défaut pression H2 : Pressure fault
/DRW_08.B2	49		H2 : Défaut pression H2 : Pressure fault
/DRW_07.C1	1		Q11-S1 11-12 : Position interrupteur MT
/DRW_07.D1	2		Q11-S1 11-12 : MV load break switch position
/DRW_07.C2	3		Q11-S1 23-24 : Position interrupteur MT
/DRW_07.D2	4		Q11-S1 23-24 : MV load break switch position

Format Format	Dessiné par Drawn by	Vérifié par Checked by	Approuvé par Approved by	Numéro AMT Number AMT	672803-000	-	-	Sb AB3 AC/DC	Projet Project	FBX-Sb-AB3	Version N° Revision N°	00		
A3	F.PIMENTA	D.AYNIÉ	JP.BURTHIER	Plan de borniers -X1 Terminal sheet -X1 01101				AMT	Numéro de dessin Drawing number	672803-000	Schéma type Circuit diagram type	Sch1001	Numéro de page Page number	013 / 016
	16/01/2018	16/01/2018	16/01/2018						Emplacement Location	=01 +101	Nom de la page Sheet name	TER_01		

This document is the exclusive property of Schneider Electric Industries S.A.S and shall not be used, copied or communicated to third parties without its prior authorization.
Ce document est la propriété exclusive de Schneider Electric Industries SAS et ne doit pas être utilisé, copié ou communiqué à des tiers sans son autorisation préalable.

Folio	-Ba.X1	Signal	Fonction
/DRW_07.C2	5		Q11-S1 31-32 : Position interrupteur MT Q11-S1 31-32 : MV load break switch position
/DRW_07.D2	6		
/DRW_07.C3	7		Q11-S1 43-44 : Position interrupteur MT Q11-S1 43-44 : MV load break switch position
/DRW_07.D3	8		
/DRW_07.C4	9		Q81-S1 11-12: Position Sectionneur de terre Q81-S1 11-12: Earthing switch position
/DRW_07.D4	10		
/DRW_07.C5	11		Q81-S1 11-12: Position Sectionneur de terre Q81-S1 11-12: Earthing switch position
/DRW_07.D5	12		
	13		RESERVE
	14		SPARE
	15		RESERVE
	16		SPARE
	17		RESERVE
	18		SPARE
	19		RESERVE
	20		SPARE
/DRW_03.D4	31		Commun Local/distance
/DRW_03.B4	32		Local
/DRW_03.B5	33		Distance
/DRW_08.B4	81		Communication
/DRW_08.B5	82		Communication
/DRW_08.B5	83		Communication Earth

Format Format	Dessiné par Drawn by	Vérifié par Checked by	Approuvé par Approved by	Numéro AMT Number AMT	672803-000	-	-	Sb AB3 AC/DC	Projet Project	FBX-Sb-AB3	Version N° Revision N°	00	
A3	F.PIMENTA	D.AYNIÉ	JP.BURTHIER	Plan de borniers -X1 Terminal sheet -X1 01101				AMT	Numéro de dessin Drawing number	672803-000	Schéma type Circuit diagram type	Sch1001	Numéro de page Page number
	16/01/2018	16/01/2018	16/01/2018					Emplacement Location	=01 +101	Nom de la page Sheet name	TER_02	014 / 016	

This document is the exclusive property of Schneider Electric Industries S.A. S and shall not be used, copied or communicated to third parties without its prior authorization.
 Ce document est la propriété exclusive de Schneider Electric Industries SAS et ne doit pas être utilisé, copié ou communiqué à des tiers sans son autorisation préalable.

Folio **-Ba.X2** Signal Fonction

/DRW_05.C3	74	ON	Enclenchement extérieur External closing
	75		
/DRW_05.C4	76	OFF	Commande exterieur : Commum External command : Common Déclenchement extérieur External tripping RESERVE SPARE
	77		

Format Format	Dessiné par Drawn by	Vérifié par Checked by	Approuvé par Approved by	Numéro AMT Number AMT	672803-000	-	-	Sb AB3 AC/DC	Projet Project	FBX-Sb-AB3	Version N° Revision N°	00		
A3	F.PIMENTA	D.AYNIE	JP.BURTHIER	Plan de borniers -X2 Terminal sheet -X2 01101				AMT	Numéro de dessin Drawing number	672803-000	Schéma type Circuit diagram type	Sch1001	Numéro de page Page number	015 / 016
	16/01/2018	16/01/2018	16/01/2018						Emplacement Location	=01 +101	Nom de la page Sheet name	TER_03		

This document is the exclusive property of Schneider Electric Industries S.A.S and shall not be used, copied or communicated to third parties without its prior authorization.
 Ce document est la propriété exclusive de Schneider Electric Industries SAS et ne doit pas être utilisé, copié ou communiqué à des tiers sans son autorisation préalable.

Appareil Device	Description Description		Fonction Function		Numéro article Article Number	Fabricant Manufacturer
-Ba.BR1	Faston-isole-6.35-0.8	Faston-isole-6.35-0.8			2-520183-2	AMP
-Ba.BR1M	Faston-isole-6.35-0.8	Faston-isole-6.35-0.8			2-521055-2	AMP
-Ba.F50	Coupe-circuit fusible unipolaire 5x20 xA tempo.	Single-pole cutout 5x20 xA tempo.			3101.0320	Shurter
					0034.31xx	
-C.F51	Disjoncteur BT 2 pôles protégés	LV Circuit breaker 2 protected poles			iC60N 2P C1 - A9F74201	Schneider Electric
-C.G1	Alimentation (suivant spécifications)	Supply (according to specifications)			MINI-PS	Phoenix contact
-C.H2	pressostat 1 seuil	1 threshold Pressure switch	Défaut SF6	SF6 failure	MS 12	TECSIS
-Ba.K10	Circuit imprimé commande	Control printed circuit board			CIP1	Schneider Electric
-Ba.KOFF	Relais auxiliaire instantané 110VDC 20/F	Instantaneous auxiliary relay 110VDC 20/C			RSB2A080FD	Schneider Electric
					RSZR215	
					RSZE1S48M	
-Ba.KON	Relais auxiliaire instantané 110VDC 20/F	Instantaneous auxiliary relay 110VDC 20/C			RSB2A080FD	Schneider Electric
					RSZR215	
					RSZE1S48M	
-C.M1-V3	pont redresseur moulé 25A 400V	moulded rectifier bridge 25A 400V			GBPC 25-04	Vishay
-C.M1-V4	Diode	Diode			AGSC35317-01	Schneider Electric
-P.Q11	Interrupteur MT (voir unifilaire)	MV Load break switch (see single line diagram)				Schneider Electric
-C.Q11-M1	Moteur	Motor	Motorisation	Motorization	AGSC3876x-xx	Schneider Electric
-C.Q11-M2	Moteur	Motor	Motorisation	Motorization	AGSC3876x-xx	Schneider Electric
-C.Q11-S1	Interrupteur auxiliaire 4NO 3NF	Auxiliary switch 4NO 3NC	position interrupteur sectionneur MT	MV load break and isolator switch position	AGSC38942-01	Schneider Electric
-C.Q11-S3	Fin de course à clé	Micro Switch key	Verrouillage à clé motorisation	Motorization key locking	ST435-520-002	Schneider Electric
-P.Q81	Sectionneur de terre MT (voir unifilaire)	MV Earthing switch (see single line diagram)				Schneider Electric
-C.Q81-S1	Interrupteur auxiliaire 1NO 1NF	Auxiliary switch 1NO 1NC	Position Sectionneur de terre	Earthing switch position	AGSC38939-01	Schneider Electric
-C.Q81-S51	Fin de course	Micro Switch	Position Sectionneur de terre	Earthing switch position	ST435-520-121	Schneider Electric
-Ba.R1	resistance PR01 - 18 kΩ / 1W	Resistor PR01 - 18 kΩ / 1W			PR01 18KOhms	BC Components
-Ba.R2	resistance PR01 - 18 kΩ / 1W	Resistor PR01 - 18 kΩ / 1W			PR01 18KOhms	BC Components
-Ba.S11	Commutateur 2 pos (1-2) a cle 455 (libre en pos 1-2) - 3NO+3NF	Switch 2 pos (1-2) with key 455 (free key pos 1 & 2) - 3NO+3NC			ZB5AG4	Schneider Electric
					ZB5AZ009	
					ZBE1013(x3)	
					ZBE1023(x3)	
-Ba.S61	Bouton poussoir à impulsion vert - 1NO	Pulse push button green - 1NO	Enclenchement	Closing	ZB6Z1B	Schneider Electric
					ZB6CA3	
-Ba.S62	Bouton poussoir à impulsion rouge - 1NO	Pulse push button red - 1NO	Déclenchement	Trip	ZB6Z1B	Schneider Electric
					ZB6CA4	
-Ba.X1	Bornier x pôles MSTBVK 2.5/*-G-5.08+MVSTBR 2.5/*-ST-5.08	Terminal block x poles MSTBVK 2.5/*-G-5.08+MVSTBR 2.5/*-ST-5.08			MSTBVK 2.5/*-G-5.08+MVSTBR 2.5/*-ST-5.08	Phoenix Contact
-Ba.X1	Bornier x pôles MSTBHK 2.5/*-G-5.08 + MVSTB 2.5/*-ST-5.08	Terminal block x poles MSTBHK 2.5/*-G-5.08 + MVSTB 2.5/*-ST-5.08			MSTBHK 2.5/*-G-5.08	Phoenix Contact
					MVSTB 2.5/*-ST-5.08	
-Ba.X1	Borne 4.2mm MT 1.5-QUATTRO	Terminal block 4.2mm MT 1.5-QUATTRO			3001679	Phoenix Contact
-Ba.X1	Borne 4.2mm MT 1.5-QUATTRO-PE	Terminal block 4.2mm MT 1.5-QUATTRO-PE			3001695	Phoenix Contact
-C.X10	MATE-N-LOK 6 voies Matrice femelle	MATE-N-LOK socket 6 ways Matrix			ST434-010-106	AMP
-Ba.X10	MATE-N-LOK 6voies Matrice Male	MATE-N-LOK Pin 6 ways Matrix			ST434-010-126	AMP
-C.X11	Mate_N_Lok 2 voies ligne Male	Mate_N_Lok Pin 2 ways online			ST434-010-022	AMP
-C.X12	Mate_N_Lok 2 voies en ligne femelle	Mate_N_Lok socket 2 ways online			ST434-010-002	AMP
-C.X15	Bornier x pôles IC 2.5/*-ST-5.08+MSTB 2.5/*-ST-5.08	Terminal block x poles IC 2.5/*-ST-5.08+MSTB 2.5/*-ST-5.08			IC 2.5/*-ST-5.08+MSTB 2.5/*-ST-5.08	Phoenix Contact
-Ba.X2	Bornier x pôles MSTBHK 2.5/*-G-5.08 + MVSTB 2.5/*-ST-5.08	Terminal block x poles MSTBHK 2.5/*-G-5.08 + MVSTB 2.5/*-ST-5.08			MSTBHK 2.5/*-G-5.08	Phoenix Contact
					MVSTB 2.5/*-ST-5.08	
-Ba.X20	Connecteur 2 voies	Connector 2 ways			IC2.5/2-STGF-5.08	Phoenix Contact
-Ba.X2:25	Connecteur 2 voies	Connector 2 ways			IC2.5/2-STGF-5.08	Phoenix Contact
-Ba.X2:26	Connecteur 2 voies	Connector 2 ways			IC2.5/2-STGF-5.08	Phoenix Contact

Format Format	Dessiné par Drawn by	Vérifié par Checked by	Approuvé par Approved by	Numéro AMT Number AMT	672803-000	-	-	Sb AB3 AC/DC	Projet Project	FBX-Sb-AB3	Version N° Revision N°				
A3					Nomenclature Bill of material 01101		Schneider Electric		AMT	Numéro de dessin Drawing number	672803-000	Schéma type Circuit diagram type	Sch1001	Numéro de page Page number	016 / 016
									Emplacement Location	=01 +101		Nom de la page Sheet name	BOM_01		