

TSX ETG 1010 Module

Quick reference guide
Instruction de service
Guía de referencias rápidas
Guida di riferimento rapido

Edition June 2005

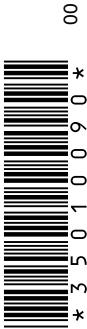
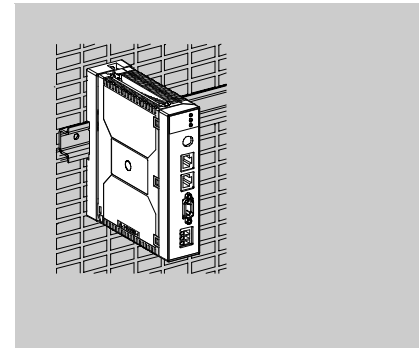

35010090 00

Schneider Electric Industries SAS

Headquarters

89, bd Franklin Roosevelt
F - 92506 Rueil Malmaison Cedex

<http://www.schneider-electric.com>

Owing to changes in standards and equipment,
the characteristics given in the text and images
in this document are not binding us
until they have been confirmed with us.

Printed in

June 2005



Telemecanique

Presentation	2
Description	3
Description of the Support Plate.....	4
Mounting.....	6
Connection of Supply Terminal Block	8
Connection of RJ45 Ethernet Connector.....	9
Connection of RS232 Modem Connector	10
Connection of RJ45 Uni-Telway Connector	11
Connection of Mini-Din Connector	12
Diagnostics	13
Electrical Characteristics	14
Conditions of Use	15
Standards.....	16
Quick Setup Diagram	17

Presentation

The TSX ETG 1010 module is a stand-alone TCP/IP-Uni-Telway gateway module used to connect a Uni-Telway device to a TCP/IP network. It is a C20 class device (TR standard). It has a built-in RS232 serial link which can be used to connect an external modem.

Mainly, this module is used to perform the following functions:

- UNI-TE and Modbus messaging over TCP/IP,
- SMTP service,
- SNMP service,
- Embedded Web server,
- option of having a user website.

Description

The TSX ETG 1010 module is a single format module, external to the PLC, mounted on a support plate which can be fixed to a DIN AM1-DE200 or AM1-DP200 rail, or on a Telequick AM1-PA pre-slotted mounting plate.

This module is made up of the following components:

- 1 3 LED indicators:
 - a **RUN/UTW** LED (green),
 - an **ERR** LED (red),
 - an **ETHERNET** LED (orange),
- 2 a Mini-Din connector for a Terminal port,
- 3 an RJ45 connector for an RS 485 Uni-Telway link,
- 4 an RJ45 connector for an Ethernet link,
- 5 a 9-pin SUB D connector for a modem link,
- 6 a screw terminal block for 24 VDC power supply connection,
- 7 a support plate for fixing the module directly to an AM1-DE200/DP200 DIN rail or to a Telequick AM1-PA pre-slotted plate.

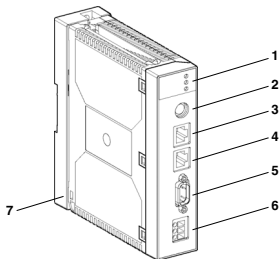

Description of the Support Plate

- 1 Two 5.5 mm diameter holes for fixing the plate to a panel or the AM1-PA pre-slotted mounting plate with a mounting distance of 140 mm (mounting distance for TSX Micros).
- 2 M4 fixing hole for securing the TSX ETG 1010 module.
- 3 Two 6.5 mm diameter holes for fixing the plate to a panel or the AM1-PA pre-slotted mounting plate with a mounting distance of 88.9 mm (mounting distance for TSX Premiums).
- 4 Holes to be used as anchor-points for the pins situated to the rear of the module base.

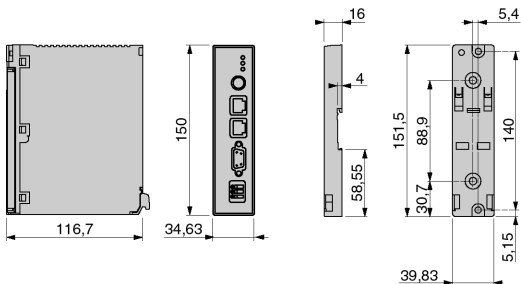
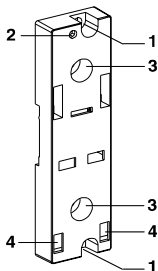

Dimensions of the module with cables:

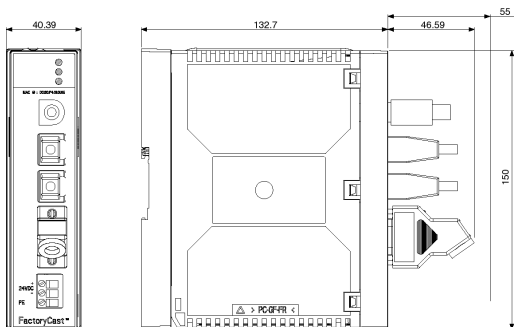

Mounting

Mounting the module on a DIN rail or Telequick plate:

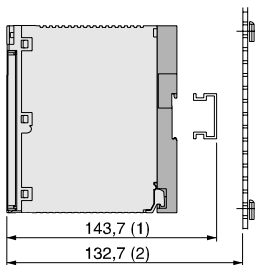
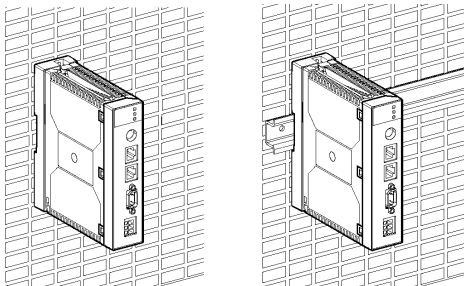

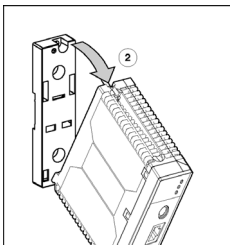
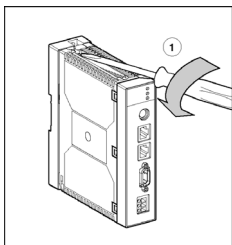

Connection of Supply Terminal Block

The power supply terminal block consists of three front screw terminals. Each terminal takes a cable of maximum width of 2.5 mm.

Illustration:

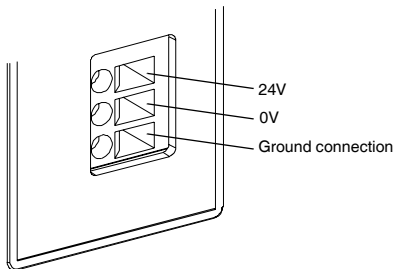

Connection of RJ45 Ethernet Connector**Pin: Signal:**

1	Tx+
2	Tx-
3	Rx+
4	Not connected
5	Not connected
6	Rx-
7	Non connected
8	Not connected

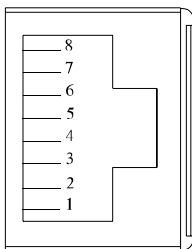

Connection of RS232 Modem Connector

Pin:	Signal:
1	Data Carrier Detect
2	Received Data
3	Transmitted Data
4	Data Terminal Ready
5	Signal Ground
6	Data Set Ready
7	Request to send
8	Clear to send
9	Ring Indicator

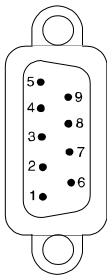

Connection of RJ45 Uni-Telway Connector

Pin: Signal:

1	Not connected
2	Not connected
3	Not connected
4	D1/D(B)
5	D0/D(A)
6	Not connected
7	Non connected
8	Common

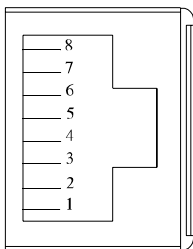

Connection of Mini-Din Connector

Pin: Signal:

1	D(B)
2	D(A)
3	Reserved
4	Not connected
5	Not connected
6	Not connected
7	0 V
8	5 V

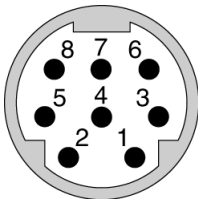

Diagnostics

Module status	RUN/ UTW	ERR	Comments
Power on.	●	●	Transient state.
Self-test in progress.	●	●	-
Module hardware fault.	○	●	Replace the module.
Configuration error: invalid IP address, connection to Master PLC lost or difference in Uni-Telway speed between the Master and the TSX ETG 1010.	○	●	HTTP server can still be accessed.
RJ45 Ethernet not connected to the module.	○	(3x) ●	-
TSX ETG 1010 BOOTP DHCP (FDR) client: the module is configured in auto-configuration mode and is awaiting a response from the server.	○	(5x) ●	Waiting time: approx. 5 minutes
TSX ETG 1010 BOOTP or DHCP (FDR) client: no response from server.	●	(6x) ●	Downgraded mode: the module uses its configuration stored in flash memory.
Operating.	●	○	-
	○ Off	● On	● Flashing

Note: The ETHERNET LED flashes according to the Ethernet communication speed and the RUN/UTW LED flashes according to the Uni-Telway communication speed.

○	RUN/UTW
○	ERR
○	ETHERNET

Electrical Characteristics

Parameter	Minimum	Nominal	Maximum
Supply voltage	19.2VDC	24VDC	30VDC
Ripple factor	-	-	5%
Permissible overvoltage (for 1 hour and for 24 hours)	-	-	34VDC
Current consumption	50ma	100ma	200ma
Power loss	-	2.4W	4W
Length of power outage in the absence of power supply	-	-	1ms

Conditions of Use

Conditions of use:

- temperature: from 0 to +60 °C,
- Relative Humidity: 10 to 95 % (without condensation),
- altitude: from 0 to 2000 m,
- vibration immunity: compliant with IEC 68-2-6 test Fc,
- shock immunity: compliant with IEC 68-2-27 test Ea,
- resistance to dropping, in packaging: compliant with IEC/EN 61131-2.

Storage conditions:

- temperature: from -25 to +70 °C,
- Relative Humidity: 5 to 95% (without condensation).

Standards

The TSX ETG 1010 module complies with the following standards:

- ISO/IEC 8802-3,
- ANSI/IEEE Std 802.3-2002,
- UL 508,
- IEC/EN 61131-2,
- CSA C22.2 N°142,
- compliance with EN55011 class A for radiated emissions,
- CE mark,
- merchant shipping classification.

WARNING

The module must be connected to ground via the power supply terminals.

Failure to observe this precaution can result in severe injury or equipment damage.

Quick Setup Diagram

