



Main

Range of product	Harmony XB4
Product or component type	Head for illuminated selector switch
Product compatibility	Integral LED
Device short name	ZB4
Bezel material	Black metal
Head type	Standard
Mounting diameter	22 mm
Sale per indivisible quantity	1
Shape of signaling unit head	Round
Type of operator	Spring return to centre
Operator profile	Red standard handle
Operator position information	3 positions +/- 45°

Complementary

CAD overall width	29 mm
CAD overall height	29 mm
CAD overall depth	43 mm
Product weight	0.036 kg
Mechanical durability	500000 cycles
Electrical composition code	M6 for 2 contacts using single blocks in front mounting with integral LED and-transformer M10 for 2 contacts using single blocks in front mounting with integral LED M3 for 4 contacts using single blocks in front mounting with integral LED M4 for 4 contacts using single and double blocks in front mounting with integral LED

Environment

Protective treatment	TH
Ambient air temperature for storage	-40...70 °C
Ambient air temperature for operation	-40...70 °C
Overvoltage category	Class I conforming to IEC 60536
IP degree of protection	IP69 IP67 IP66 conforming to IEC 60529 IP69K
NEMA degree of protection	NEMA 13 NEMA 4X
IK degree of protection	IK06 conforming to IEC 50102

Standards	EN/IEC 60947-1 EN/IEC 60947-5-1 EN/IEC 60947-5-4 EN/IEC 60947-5-5 JIS C 4520 UL 508 CSA C22.2 No 14
Product certifications	BV CSA DNV GL LROS (Lloyds register of shipping) RINA UL listed
Vibration resistance	5 gn (f = 2...500 Hz) conforming to IEC 60068-2-6
Shock resistance	30 gn (duration = 18 ms) for half sine wave acceleration conforming- to IEC 60068-2-27 50 gn (duration = 11 ms) for half sine wave acceleration conforming- to IEC 60068-2-27

Contractual warranty

Warranty period	18 months
-----------------	-----------

Dimensions

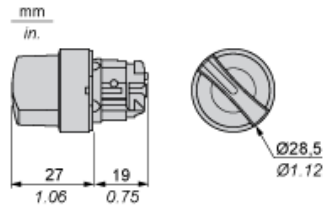

Panel Cut-out for Pushbuttons, Switches and Pilot Lights (Finished Holes, Ready for Installation)

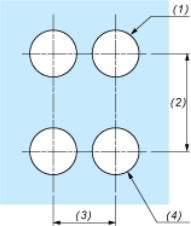
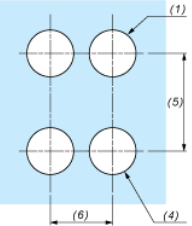
Connection by Screw Clamp Terminals or Plug-in Connectors or on Printed Circuit Board	Connection by Pushbutton Connectors
	
<p>(1) Diameter on finished panel or support (2) 40 mm min. / 1.57 in. min. (3) 30 mm min. / 1.18 in. min. (4) $\varnothing 22.5$ mm / 0.89 in. recommended ($\varnothing 22.3$ mm $^{+0.4}$ / 0.88 in. $^{+0.016}$) (5) 45 mm min. / 1.78 in. min. (6) 32 mm min. / 1.26 in. min.</p>	

Pushbuttons, Switches and Pilot Lights for Printed Circuit Board Connection

Panel Cut-outs (Viewed from Installer's Side)

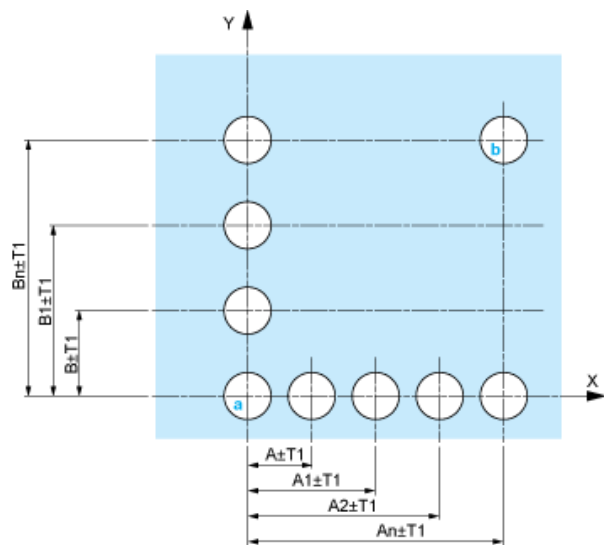

- A: 30 mm min. / 1.18 in. min.
 B: 40 mm min. / 1.57 in. min.

Printed Circuit Board Cut-outs (Viewed from Electrical Block Side)

Dimensions in mm

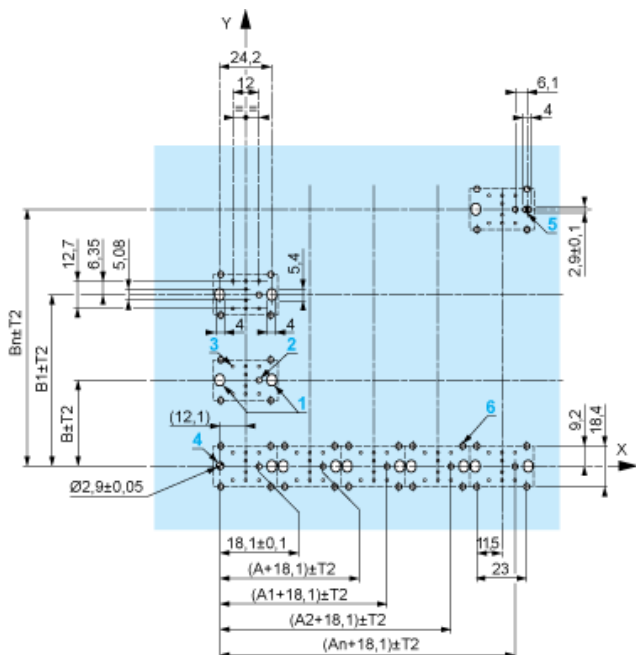

A: 30 mm min.

B: 40 mm min.

Dimensions in in.

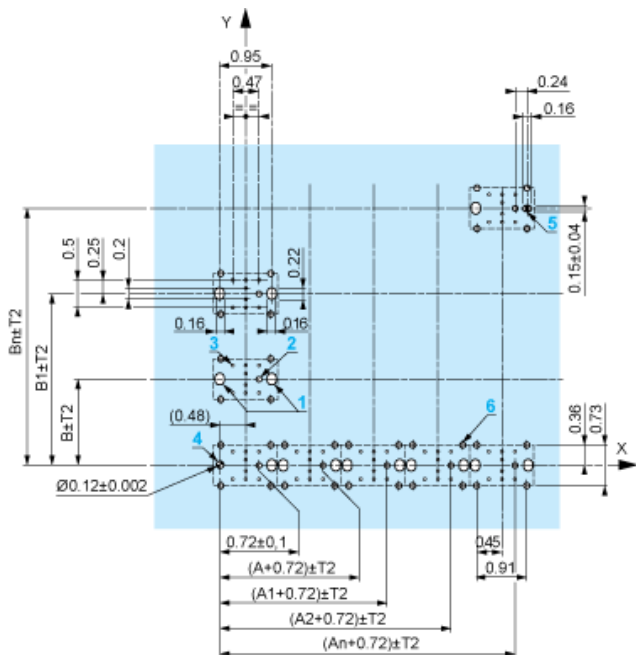

A: 1.18 in. min.

B: 1.57 in. min.

General Tolerances of the Panel and Printed Circuit Board

The cumulative tolerance must not exceed 0.3 mm / 0.012 in: $T1 + T2 = 0.3 \text{ mm max.}$

Installation Precautions

- Minimum thickness of circuit board: 1.6 mm / 0.06 in.
- Cut-out diameter: 22.4 mm \pm 0.1 / 0.88 in. \pm 0.004
- Orientation of body/fixing collar ZB4 BZ009: $\pm 2^\circ 30'$ (excluding cut-outs marked a and b).
- Tightening torque of screws ZBZ 006: 0.6 N.m (5.3 lbf.in) max.
- Allow for one ZB4 BZ079 fixing collar/pillar and its fixing screws:
 - every 90 mm / 3.54 in. horizontally (X), and 120 mm / 4.72 in. vertically (Y).
 - with each selector switch head (ZB4 BD*, ZB4 BJ*, ZB4 BG*).

The fixing centers marked a and b are diagonally opposed and must align with those marked 4 and 5.

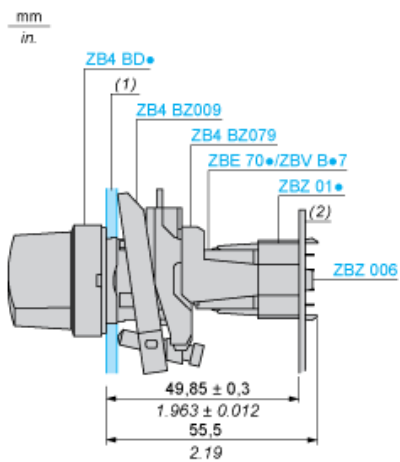

- (1) Panel
(2) Printed circuit board

Mounting of Adapter (Socket) ZBZ 01•

- 1 2 elongated holes for ZBZ 006 screw access
- 2 1 hole $\varnothing 2.4 \text{ mm} \pm 0.05 / 0.09 \text{ in.} \pm 0.002$ for centring adapter ZBZ 01•
- 3 8 × $\varnothing 1.2 \text{ mm} / 0.05 \text{ in.}$ holes
- 4 1 hole $\varnothing 2.9 \text{ mm} \pm 0.05 / 0.11 \text{ in.} \pm 0.002$, for aligning the printed circuit board (with cut-out marked a)
- 5 1 elongated hole for aligning the printed circuit board (with cut-out marked b)
- 6 4 holes $\varnothing 2.4 \text{ mm} / 0.09 \text{ in.}$ for clipping in adapter ZBZ 01•

Dimensions An + 18.1 relate to the $\varnothing 2.4 \text{ mm} \pm 0.05 / 0.09 \text{ in.} \pm 0.002$ holes for centring adapter ZBZ 01•.

Electrical Composition Corresponding to Code M3

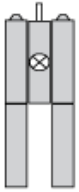

Electrical Composition Corresponding to Code M4

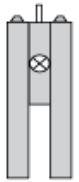

Electrical Composition Corresponding to Codes M6 and P2

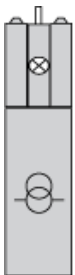

Electrical Composition Corresponding to Codes M5, M10, MF1, MR1 and MF2

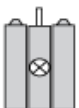

Legend

Single contact



Double contact



Light block







Possible location



Sequence of Contacts Fitted to 3-position Selector Switch Body





Position 315°



Push	Position	Top			
Bottom					
Location		Left	Right		
State		1	0		
Contacts	N/O		closed	open	
N/C		open	closed		

Position 0°



Push	Position	Top			
Bottom					
Location		Left	Right		
State		0	0		
Contacts	N/O		open	open	
N/C		closed	closed		

Position 45°



Push	Position	Top	<input type="checkbox"/>		
Bottom	<input type="checkbox"/>	<input type="checkbox"/>			
Location		Left	Right		
State		0	1		
Contacts	N/O		open	closed	
N/C		closed	open		

Product Life Status : **Commercialised**