



Main

Range of product	OsiSense XS
Series name	General purpose
Sensor type	Inductive proximity sensor
Device application	-
Sensor name	XS5
Sensor design	Cylindrical M18
Size	62 mm
Body type	Fixed
Detector flush mounting acceptance	Flush mountable
Material	Metal
Type of output signal	Discrete
Wiring technique	2-wire
[Sn] nominal sensing distance	5 mm
Discrete output function	1 NO
Output circuit type	DC
Electrical connection	Remote male connector M12 4 pins, pin assignment : 3-4
Cable length	0.8 m
[Us] rated supply voltage	12...48 V DC
Switching capacity in mA	1.5...100 mA DC with overload and short-circuit protection
IP degree of protection	IP68 double insulation conforming to IEC 60529 IP65 conforming to IEC 60529 IP69K conforming to DIN 40050

Complementary

Thread type	M18 x 1
Detection face	Frontal
Front material	PPS
Enclosure material	Nickel plated brass
Operating zone	0...4 mm
Differential travel	1...15% of Sr
Cable composition	2 x 0.34 mm ²
Wire insulation material	PvR
Status LED	1 LED (yellow) for output state
Supply voltage limits	10...58 V DC
Residual current	<= 0.5 mA, open state
Switching frequency	<= 3000 Hz
Voltage drop	<= 4 V, closed state

Delay first up	<= 10 ms
Delay response	<= 0.15 ms
Delay recovery	<= 0.2 ms
Marking	CE
Threaded length	52 mm
Height	18 mm
Length	62 mm
Product weight	0.15 kg

Environment

Product certifications	CCC CSA UL
Ambient air temperature for operation	-25...70 °C
Ambient air temperature for storage	-40...85 °C
Vibration resistance	25 gn, amplitude: +/- 2 mm (f = 10...55 Hz) conforming to IEC 60068-2-6
Shock resistance	50 gn (duration = 11 ms) conforming to IEC 60068-2-27

Offer Sustainability

RoHS (date code: YYWW)	Compliant - since 0840 - Schneider Electric declaration of conformity Schneider Electric declaration of conformity
Product environmental profile	Available End Of Life Information
Product end of life instructions	Available

Contractual warranty

Warranty period	18 months
-----------------	-----------

Dimensions

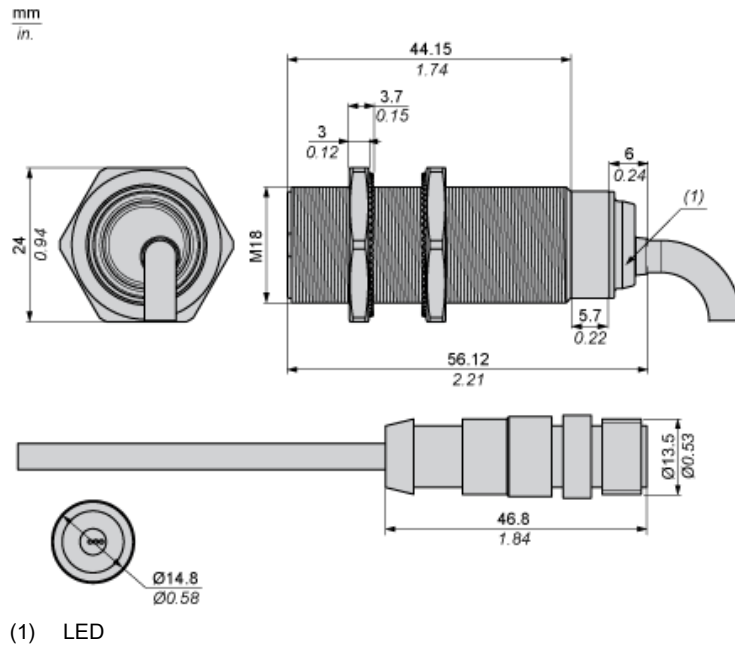

Minimum Mounting Distances

Side by side

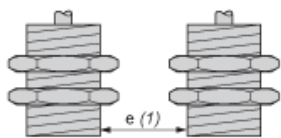

$e (1) \geq 0 \text{ mm}/0.39 \text{ in.}$

Face to face

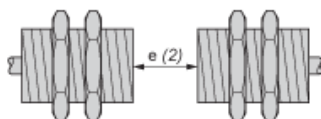

$e (2) \geq 0 \text{ mm}/2.36 \text{ in.}$

Facing a metal object

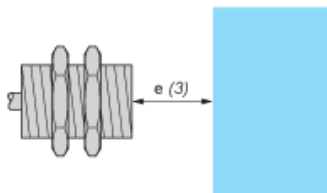

$e (3) \geq 5 \text{ mm}/0.60 \text{ in.}$

Wiring Schemes

2-Wire Non-polarised

M12 connector

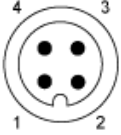

NO output

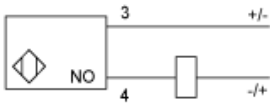

Performance Curves

Standard Steel Target : 18x18x1 mm

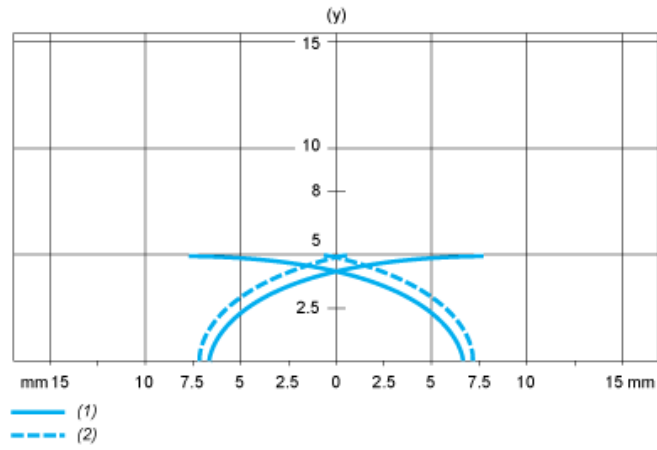

- (1) Pick-up points
- (2) Drop-out points (object approaching from the side)
- (y) Sensing distance in mm

Product Life Status : **Commercialised**