

Product data sheet

Characteristics

XCKJ1161H7

limit switch XCKJ - metal end plunger - 1C/O - snap action - 1/2NPT



Product availability: Non-Stock - Not normally stocked in distribution facility

Price*: 135.00 USD

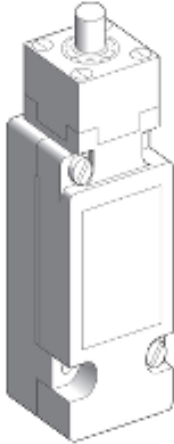

Main

Range of product	OsiSense XC
Series name	Standard format
Product or component type	Limit switch
Device short name	XCKJ
Sensor design	Form B conforming to CENELEC EN 50041
Body type	Plug-in body
Head type	Plunger head
Material	Metal
Body material	Zamak
Head material	Zamak
Fixing mode	By the body
Movement of operating head	Linear
Type of operator	Spring return plunger metal
Type of approach	Vertical approach 1 direction
Cable entry	1 entry tapped for 1/2" NPT cable gland
Number of poles	1
Contacts type and composition	1 C/O
Contact operation	Snap action

Complementary

Switch actuation	On end
Electrical connection	Screw-clamp terminals, clamping capacity: 1 x 0.75...2 x 1.5 mm ²
Contacts insulation form	Zb
Number of steps	1
Positive opening	Without
Minimum force for tripping	20 N
Maximum actuation speed	1.64 ft/s (0.5 m/s)
Repeat accuracy	0.1 mm on the tripping points with 1 million operating cycles

[Ie] rated operational current	3 A at 240 V, AC-15, A300 conforming to EN/IEC 60947-5-1 appendix A 0.27 A at 250 V, DC-13, Q300 conforming to EN/IEC 60947-5-1 appendix A
[Ithe] conventional enclosed thermal current	10 A
[Ui] rated insulation voltage	300 V conforming to CSA C22.2 No 14 500 V degree of pollution 3 conforming to IEC 60947-1 300 V conforming to UL 508
Resistance across terminals	<= 25 MOhm conforming to IEC 60255-7 category 3
[Uimp] rated impulse withstand voltage	6 kV conforming to IEC 60664 6 kV conforming to IEC 60947-1
Short-circuit protection	10 A by gG cartridge fuse
Electrical durability	5000000 cycles, DC-13, inductive load type, 24 V, 10 W, operating rate: <= 60 cyc/m-n, load factor: 0.5 conforming to IEC 60947-5-1 appendix C 5000000 cycles, DC-13, inductive load type, 48 V, 7 W, operating rate: <= 60 cyc/m-n, load factor: 0.5 conforming to IEC 60947-5-1 appendix C 5000000 cycles, DC-13, inductive load type, 120 V, 4 W, operating rate: <= 60 cyc/m-n, load factor: 0.5 conforming to IEC 60947-5-1 appendix C
Mechanical durability	30000000 cycles
Width	1.69 in (43 mm)
Height	3.31 in (84 mm)
Depth	1.42 in (36 mm)
Product weight	0.95 lb(US) (0.43 kg)
Terminals description ISO n°1	(11-12)NC (13-14)NO
Compatibility code	XCKJ
Specific application	Industrial

Environment

Shock resistance	50 gn (duration = 11 ms) conforming to IEC 60068-2-27
Vibration resistance	25 gn (f = 10...500 Hz) conforming to IEC 60068-2-6
IP degree of protection	IP66 conforming to IEC 60529
IK degree of protection	IK07 conforming to EN 50102
Overvoltage category	Class I conforming to NF C 20-030 Class I conforming to IEC 61140
Ambient air temperature for operation	-13...158 °F (-25...70 °C)
Ambient air temperature for storage	-40...158 °F (-40...70 °C)
Protective treatment	TC
Product certifications	CCC UL CSA
Standards	CENELEC EN 50041 EN 60204-1 IEC 60947-5-1 IEC 60204-1 CSA C22.2 No 14 EN 60947-5-1 UL 508

Ordering and shipping details

Category	22411 - LIMIT SWITCHES,IEC,XCKJ
Discount Schedule	T
GTIN	003389118120778
Nbr. of units in pkg.	1
Package weight(Lbs)	0.96999999999999997
Returnability	N
Country of origin	FR

Offer Sustainability

Sustainable offer status	Green Premium product
RoHS (date code: YYWW)	Compliant - since 1103 - Schneider Electric declaration of conformity  Schneider-Electric declaration of conformity
REACH	Reference not containing SVHC above the threshold
Product end of life instructions	Need no specific recycling operations
California proposition 65	WARNING: This product can expose you to chemicals including:
----- Substance 1	Diisononyl phthalate (DINP), which is known to the State of California to cause cancer, and
----- Substance 2	Di-isodecyl phthalate (DIDP), which is known to the State of California to cause birth defects or other reproductive harm.
----- More information	For more information go to www.p65warnings.ca.gov

Contractual warranty

Warranty period	18 months
-----------------	-----------

Dimensions

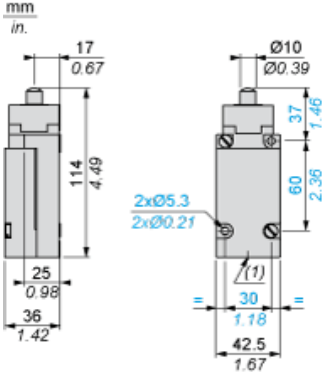

(1) 1 tapped entry 1/2" NPT

Mounting with Cable Entry

Position of Cable Gland

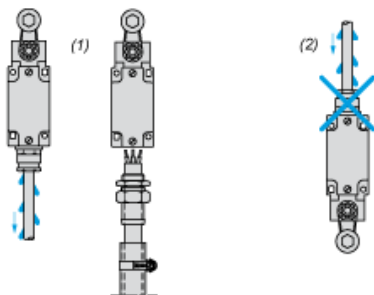

- (1) Recommended
- (2) To be avoided

Wiring Diagram

Single-pole CO Snap Action

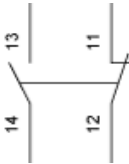

Characteristics of Actuation

Switch Actuation on End

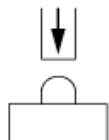

Functionnal Diagram

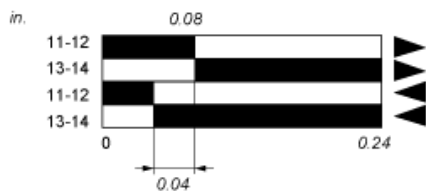
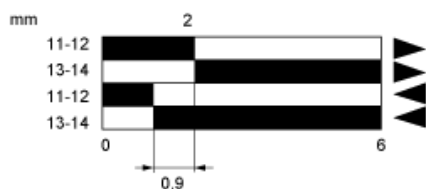

- (1)
- (2)
- ▶ (3)
- ◀ (4)

- (1) Closed
- (2) Open
- (3) Tripping
- (4) Resetting

Product Life Status : **Commercialised**