



### Main

Range of product	Harmony XB5
Sale per indivisible quantity	1
Product or component type	Monolithic timer

### Complementary

Bezel material	Plastic
Fixing collar material	Plastic
Mounting diameter	22 Mm
Thickness	6 Mm
Shape of signaling unit head	Round
Time delay range	0.5...10 min
Time delay type	A
Repeat accuracy	+/- 0.5 %
Setting accuracy of time delay	+/- 10 % of full scale at 25 °C conforming to EN/IEC 61812-1
Temperature drift	+/- 0.05 %/°C
Voltage drift	+/- 0.2 %/V
Protection type	Overvoltage protection
Output type	Open collector PNP
Temporary permissible current	10 A for 0.01 s
Minimum switching current	10 MA
Maximum voltage drop	5 V
Network type	AC
Maximum residual current	5 MA
Maximum power consumption in W	1 W
Maximum power consumption in VA	1.5 VA
Reset time	30 Ms after time delay on de-energisation 60 Ms during time delay on de-energisation
Local signalling	LED green, steady for timing in progress LED, stop or suppress for no timing in progress and output relay energised
[Us] rated supply voltage	110...230 V AC/DC
Supply voltage limits	93.5...253 V AC/DC
Output short-circuit protection	With
Connections - terminals	Screw terminals 1 x 4 mm <sup>2</sup> conforming to EN/IEC 60947-1 Screw terminals 1 x 2.5 mm <sup>2</sup> conforming to EN/IEC 60947-1
IP degree of protection	IP65 front: conforming to IEC 60529 IP20 back: conforming to IEC 60529

Ambient air temperature for operation	-20...60 °C
Ambient air temperature for storage	-20...80 °C
Tightening torque	0.5 N.M
Dielectric strength	1500 V conforming to EN/IEC 61812-1
[Ui] rated insulation voltage	250 V conforming to EN 60947-1 250 V conforming to IEC 60664-1
[Uimp] rated impulse withstand voltage	4 KV EN 60947-1 4 KV IEC 60664-1
Surge withstand	2 KV, level 2 conforming to IEC 61000-4-5
Overvoltage category	Class 3 conforming to IEC 60536 Class 3 conforming to IEC 60664-1
Pollution degree	3
Vibration resistance	0.15 mm (f= 10...60 Hz) conforming to IEC 60068-2-6 2 gn (f= 60...150 Hz) conforming to IEC 60068-2-6
Shock resistance	+/- 15 gn for 11 ms (6 shocks on each axis) conforming to IEC 60068-2-27
Resistance to fast transients	2 KV class level 3 conforming to IEC 61000-4-4
Electromagnetic compatibility	Electrostatic discharge 6 kV level 3 conforming to IEC 61000-4-2 Electromagnetic emission class B conforming to IEC 55011
Resistance to electromagnetic fields	10 V/M 80 MHz...1 GHz level 3 conforming to IEC 61000-4-3 3 V/M 1.4...2 GHz level 3 conforming to IEC 61000-4-3 1 V/M 2...2.7 GHz level 3 conforming to IEC 61000-4-3
Immunity to radioelectric fields	10 V level 3 conforming to EN/IEC 61000-4-6
Disturbance radiated/conducted	Class B conforming to EN 50022
Standards	UL 508 EN/IEC 61812-1
Product certifications	UL listed CE
Height	62 Mm
Diameter	29 Mm
Net weight	0.027 Kg
Device presentation	Complete product

## Offer Sustainability

Sustainable offer status	Green Premium product
REACH Regulation	<a href="#">REACH Declaration</a>
REACH free of SVHC	Yes
EU RoHS Directive	Pro-active compliance (Product out of EU RoHS legal scope) <a href="#">EU RoHS Declaration</a>
Environmental Disclosure	<a href="#">Product Environmental Profile</a>
Circularity Profile	<a href="#">End Of Life Information</a>
WEEE	The product must be disposed on European Union markets following specific waste collection and never end up in rubbish bins

Dimensions

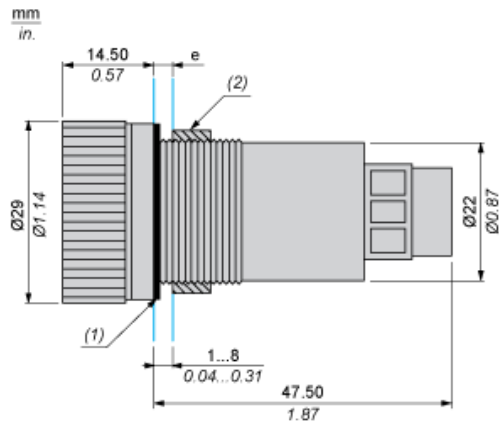

- (e) Clamping thickness: 1 mm to 6 mm / 0.03 in. to 0.24 in.
- (1) Sealing ring
- (2) Screw

Panel Cut-out for Analog Timer (Finished Holes, Ready for Installation)

Connection by Screw Clamp Terminals or Plug-in Connectors

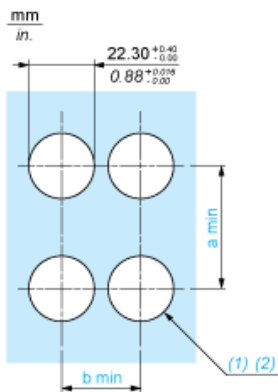

- (1) Diameter on finished panel or support  
 (2)  $\varnothing 22$  mm recommended ( $\varnothing 22.30 + 0.4$ ) /  $\varnothing 0.89$  in. recommended ( $\varnothing 0.88$  in.  $0^{+0.016}$ )

Connections	a in mm	a in in.	b in mm	b in in.
By screw clamp terminals or plug-in connector	50	1.97	30	1.18

## Wiring Diagram

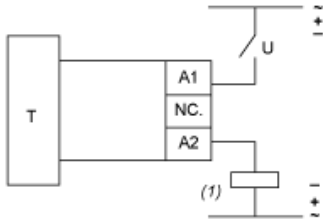

U : Supply (100...240 VAC/DC)  
T : Timer  
(1) Load  
NC : No Connection

---

Function A : On Delay Timer





---

Description

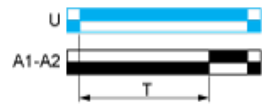
The timing period T begins on energisation with LED On. After timing, the output (A1-A2) closes and LED Off

Function: Output



-  De-energised
-  Energised
-  Output open
-  Output closed
- (U) Supply
- (A1- A2) Timed output

Product Life Status : **Commercialised**