

Main

Range of product	Zelio Relay
Series name	Miniature
Product or component type	Plug-in relay
Device short name	RXM
Contacts type and composition	2 C/O
[Uc] control circuit voltage	24 V DC
[Ithe] conventional enclosed thermal current	10 A at -40...55 °C
Status LED	With
Control type	Lockable test button
Utilisation coefficient	20 %
Sale per indivisible quantity	30

Complementary

[Ui] rated insulation voltage	250 V conforming to IEC
[Uimp] rated impulse withstand voltage	4 kV for 1.2/50 µs
Contacts material	AgNi
[Ie] rated operational current	6 A at 28 V DC (NC) conforming to IEC 6 A at 250 V AC (NC) conforming to IEC 10 A at 28 V DC (NO) conforming to UL 10 A at 250 V AC (NO) conforming to UL
Minimum switching current	10 mA
Maximum switching voltage	250 V
Minimum switching voltage	17 V
Load current	10 A at 250 V AC 10 A at 28 V DC
Maximum switching capacity	2500 VA AC 280 W DC
Minimum switching capacity	170 mW at 10 mA, 17 V
Operating rate	<= 18000 cycles/hour no-load <= 1200 cycles/hour under load
Mechanical durability	10000000 cycles
Electrical durability	100000 cycles for resistive load
Average coil consumption	0.9 W, DC circuit
Drop-out voltage threshold	>= 0.1 U _c DC
Operating time	20 ms
Reset time	20 ms
Average resistance	650 Ohm at 20 °C +/- 10 %
Rated operational voltage limits	19.2...26.4 V DC
Safety reliability data	B10d = 100000

Protection category	RT I
Operating position	Any position
CAD overall width	26.9 mm
CAD overall height	79 mm
CAD overall depth	78.45 mm
Connections - terminals	Connector, clamping capacity: 1 x 0.25...1 x 2.5 mm ² , AWG 22...AWG 14 flexible-with cable end Connector, clamping capacity: 2 x 0.25...2 x 1 mm ² , AWG 22...AWG 17 flexible-with cable end Connector, clamping capacity: 1 x 0.5...1 x 2.5 mm ² , AWG 20...AWG 14 solid-without cable end Connector, clamping capacity: 2 x 0.5...2 x 1.5 mm ² , AWG 20...AWG 16 solid-without cable end
Torque value	1 N.m 8.8 lbf.in
Product weight	0.096 kg
Device presentation	Complete product
Compatibility code	RXM

Environment

Dielectric strength	1300 V AC between contacts with micro disconnection insulation 2000 V AC between coil and contact with reinforced insulation 2000 V AC between poles with basic insulation
Product certifications	CE CSA RoHS UL REACH EAC Lloyd's China RoHS
Standards	EN/IEC 61810-1 IEC 61984 UL 508 CSA C22.2 No 14
Ambient air temperature for storage	-40...85 °C
Ambient air temperature for operation	-40...55 °C
Vibration resistance	3 gn (f = 10...150 Hz), amplitude +/- 1 mm (on 5 cycles in operation) 5 gn (f = 10...150 Hz), amplitude +/- 1 mm (on 5 cycles not operating)
IP degree of protection	IP20 conforming to EN/IEC 60529
Shock resistance	10 gn in operation 30 gn not operating
Pollution degree	2

Offer Sustainability

RoHS (date code: YYWW)	Compliant  Schneider Electric Declaration Of Conformity
REACH	Reference not containing SVHC above the threshold

Contractual warranty

Warranty period	18 months
-----------------	-----------

Dimensions

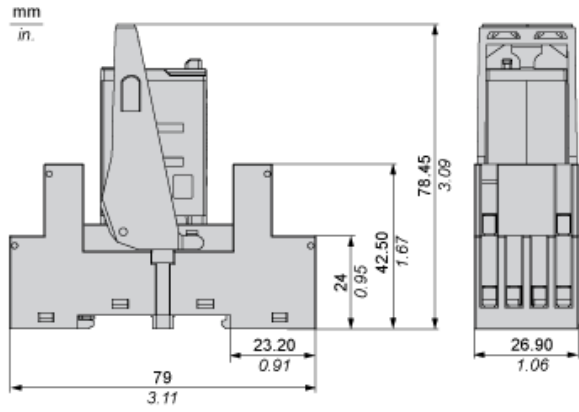

Wiring Diagram

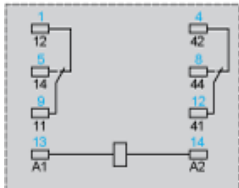
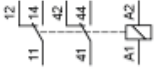

Symbols shown in blue correspond to Nema marking.

Electrical Durability of Contacts

Durability (inductive load) = durability (resistive load) x reduction coefficient.

Resistive AC load

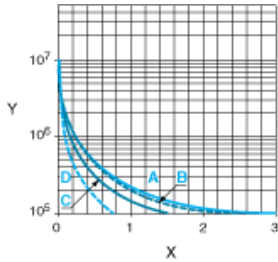

- X Switching capacity (kVA)
- Y Durability (Number of operating cycles)
- A RXM2AB...
- B RXM3AB...
- C RXM4AB...
- D RXM4GB...

Reduction coefficient for inductive AC load (depending on power factor $\cos \phi$)

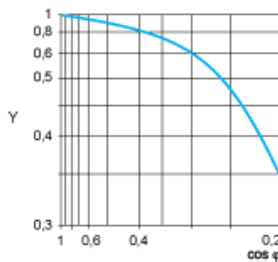

- Y Reduction coefficient (A)

Maximum switching capacity on resistive DC load

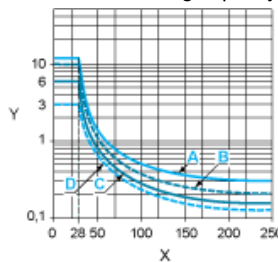

- X Voltage DC
- Y Current DC
- A RXM2AB...
- B RXM3AB...
- C RXM4AB...
- D RXM4GB...

Note : These are typical curves, actual durability depends on load, environment, duty cycle, etc.

Product Life Status : Commercialised