



Main

Range of product	Zelio Relay
Series name	Interface relay
Product or component type	Plug-in relay
Device short name	RXG
Contacts type and composition	1 C/O

Complementary

Status LED	With
Contacts material	Silver alloy (AgSnO ₂ In ₂ O ₃)
Contact resistance	100 MOhm
[I _{th}] conventional enclosed thermal current	10 A
[I _e] rated operational current	10 A at 30 V (DC) conforming to UL 10 A at 30 V (DC) conforming to IEC 10 A at 250 V (AC) conforming to IEC 10 A at 250 V (AC) conforming to UL
Maximum switching voltage	250 V
Load current	10 A
Maximum switching capacity	2500 VA AC 300 W DC
Minimum switching capacity	500 mW at 100 mA, 5 V DC
Operating rate	<= 1800 cycles/hour under load <= 18000 cycles/hour no-load
Utilisation coefficient	20 %
Mechanical durability	10000000 Cycles
Electrical durability	100000 Cycles resistive load
[U _i] rated insulation voltage	250 V conforming to IEC
[U _{imp}] rated impulse withstand voltage	6 KV 1.2/50 µs between coil and contact 1.2 KV 1.2/50 µs between contacts 2.5 KV 1.2/50 µs between terminals and LTB area 1.5 KV 1.2/50 µs between terminals and base
Dielectric strength	1000 V AC between contacts with micro disconnection 1300 V between terminals and base with basic insulation 3000 V between terminals and LTB area with basic insulation 5000 V AC between coil and contact with reinforced insulation
Resistance	23500 Ohm +/- 15 %
Insulation resistance	1000 MOhm at 500 V DC
Test levels	Level A group mounting
Mounting position	Any position
Average coil consumption	0.96 VA AC 50...60 Hz





The information provided in this documentation contains general descriptions and/or technical characteristics of the performance of the products contained herein. This documentation is not intended as a substitute for and is not to be used for determining suitability or reliability of these products for specific user applications. It is the duty of any such user or integrator to perform the appropriate and complete risk analysis, evaluation and testing of the products with respect to the relevant specific application or use thereof. Neither Schneider Electric Industries SAS nor any of its affiliates or subsidiaries shall be responsible or liable for misuse of the information contained herein.

Drop-out voltage threshold	>= 0.3 Uc AC
Electrical insulation class	Class F
Operating time	20 ms
Reset time	20 Ms
[Uc] control circuit voltage	230 V AC
Safety reliability data	B10d = 100000
Colour of cover	Transparent
Torque value	0.8 N.M 7.0 Lbf.In
Connections - terminals	Connector, 1 x 0.25...1 x 2.5 mm ² (AWG 22...AWG 14) flexible with cable end Connector, 2 x 0.25...2 x 1 mm ² (AWG 22...AWG 17) flexible with cable end Connector, 1 x 0.5...1 x 2.5 mm ² (AWG 20...AWG 14) solid without cable end Connector, 2 x 0.5...2 x 1.5 mm ² (AWG 20...AWG 16) solid without cable end
Net weight	0.058 Kg
Device presentation	Complete product

Environment

Vibration resistance	3 gn, amplitude = +/- 1.5 mm (f = 10...150 Hz)in operation 5 gn, amplitude = +/- 1.5 mm (f = 10...150 Hz)not in operation
IP degree of protection	IP20
Shock resistance	20 gn in operation 100 gn not in operation
Protection category	RT I
Standards	IEC 61810-1 CSA C22.2 No 14 UL 508 IEC 61984
Product certifications	EAC REACH RoHS CSA UL CE China RoHS
Pollution degree	2
Overvoltage category	III
Ambient air temperature for storage	-40...85 °C
Ambient air temperature for operation	-40...70 °C
Relative humidity	10...85 %

Offer Sustainability

Sustainable offer status	Green Premium product
REACH Regulation	 REACH Declaration
REACH free of SVHC	Yes
EU RoHS Directive	Pro-active compliance (Product out of EU RoHS legal scope)  EU RoHS Declaration
Toxic heavy metal free	Yes
Mercury free	Yes
RoHS exemption information	 Yes
China RoHS Regulation	 China RoHS Declaration
Environmental Disclosure	 Product Environmental Profile
Circularity Profile	No need of specific recycling operations
WEEE	The product must be disposed on European Union markets following specific waste collection and never end up in rubbish bins

Contractual warranty

Warranty	18 months
----------	-----------

Dimensions

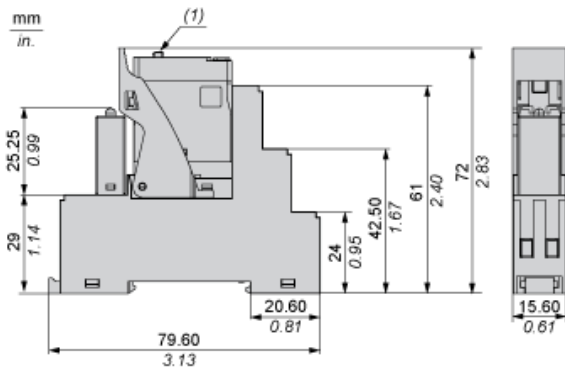

(1) Push button (if any)

Wiring Diagram

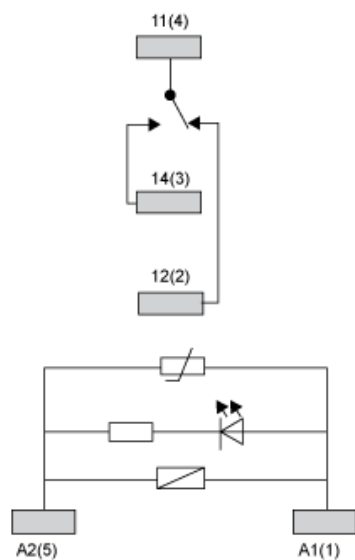

Performance Curves

Maximum Switching Capacity

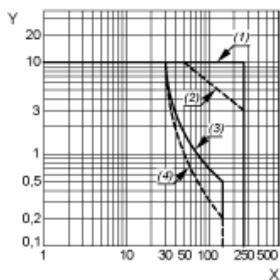

- X : Switching voltage (V)
- Y : Switching current (A)
- (1) AC Resistive Load
- (2) AC Inductive Load $\cos(\phi)=0.4$
- (3) DC Resistive Load
- (4) DC Inductive Load (L/R=7ms)

Life Expectancy

Resistive Load

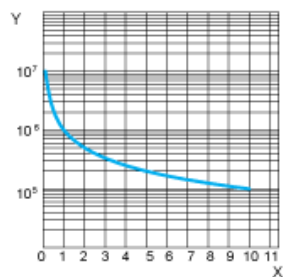

- X : Contact Current (A)
- Y : Operating Cycle Number

Life Expectancy

Inductive Load

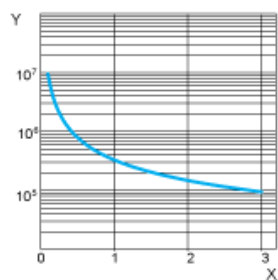

- X : Contact Current (A)
- Y : Operating Cycle Number

NOTE: These are typical curves, actual durability depends on load, environment, duty cycle, etc.

Coil Operating Range

AC Coil Operating Range VS Ambient Temperature

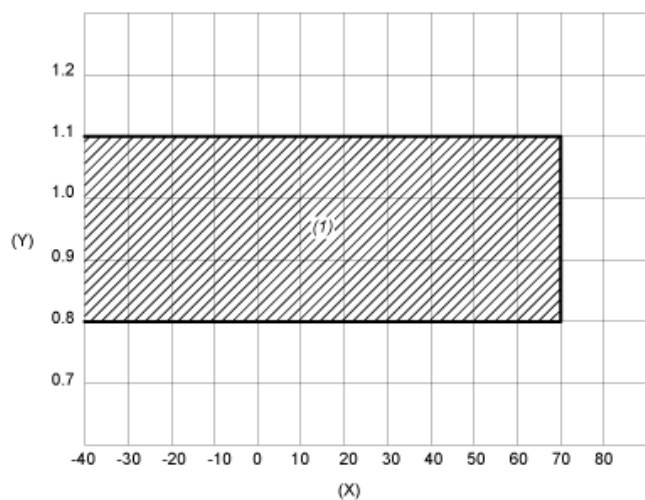

- X : Ambient temperature (°C)
- Y : Coil voltage (U/Uc)
- (1) Permitted operating range area

Product Life Status : **Commercialised**