

THREE PHASE WIRING FOR ASCO 7000 SERIES AUTOMATIC DELAYED TRANSITION TRANSFER SWITCHES TYPE H7ADTS RATED 600, 800, 1000 & 1200 AMPERES

FEATURES, SETTINGS, OPERATION, ACCESSORIES & NOTES

THE FOLLOWING FEATURES AND RELATED SETTINGS ARE PART OF THE GROUP 5 CONTROL PANEL'S USER CONFIGURABLE PARAMETERS. FOR DETAILED INFORMATION REGARDING THE CONFIGURATION OF THESE PARAMETERS AND OTHER FEATURES OF THE GROUP 5 CONTROL PANEL, REFER TO THE GROUP 5 CONTROL PANEL FOR ASCO 7000 SERIES AUTOMATIC TRANSFER SWITCHES USER'S GUIDE (PART NO. 381333-126) PROVIDED WITH EVERY 7000 SERIES AUTOMATIC TRANSFER SWITCH.

THE NOMINAL OPERATING VOLTAGE & FREQUENCY IS PRE-PROGRAMMED AT THE FACTORY BASED ON THE NAMEPLATE DATA PRINTED ON THE TRANSFER SWITCH & CONTROL PANEL NAMEPLATES.

VOLTAGE & FREQUENCY SENSING

THE FOLLOWING SETTINGS ARE EXPRESSED AS A PERCENTAGE OF THE CONTROL PANEL'S NOMINAL VOLTAGE SETTING UNLESS STATED OTHERWISE. ALL SETTINGS ARE ADJUSTABLE IN INCREMENTS OF 1%.

A. RMS VOLTAGE SENSING ON ALL PHASES OF THE NORMAL & EMERGENCY SOURCES.

PARAMETER	RANGE OF SETTINGS	DEFAULT SETTING
NORMAL VOLTAGE DROPOUT	70-98%	85%
NORMAL VOLTAGE PICKUP	85-100%	90%
NORMAL OVER VOLTAGE TRIP	102-115%	OFF
NORMAL VOLTAGE UNBALANCE	YES/NO	NO
NORMAL VOLTAGE UNBALANCE DROPOUT	5-20% OF AVG. NORMAL VOLTAGE	20% (if ON)
NORMAL VOLTAGE UNBALANCE PICKUP	3-18% OF AVG. NORMAL VOLTAGE	10% (if ON)
EMERGENCY VOLTAGE DROPOUT	70-98%	75%
EMERGENCY VOLTAGE PICKUP	85-100%	90%
EMERGENCY OVER VOLTAGE TRIP	102-115%	OFF
EMERGENCY VOLTAGE UNBALANCE	YES/NO	NO
EMERGENCY VOLTAGE UNBALANCE DROPOUT	5-20% OF AVG. EMERGENCY VOLTAGE	20% (if ON)
EMERGENCY VOLTAGE UNBALANCE PICKUP	3-18% OF AVG. EMERGENCY VOLTAGE	10% (if ON)

B. FREQUENCY SENSING OF THE NORMAL & EMERGENCY SOURCES.

PARAMETER	RANGE OF SETTINGS	DEFAULT SETTING
NORMAL FREQUENCY DROPOUT	85-98%	90%
NORMAL FREQUENCY PICKUP	90-100%	95%
NORMAL OVER FREQUENCY TRIP	102-110%	OFF
EMERGENCY FREQUENCY DROPOUT	85-98%	90%
EMERGENCY FREQUENCY PICKUP	90-100%	95%
EMERGENCY OVER FREQUENCY TRIP	102-110%	OFF

TIME DELAYS

THE FOLLOWING TIME DELAY SETTINGS ALL HAVE AN ADJUSTABLE RANGE OF 0-60 min 59 sec UNLESS STATED OTHERWISE. ADJUSTABLE IN INCREMENTS OF 1 sec.
NOTE: SOME TIME DELAYS MAY BE EFFECTED BY CUSTOMER REQUESTED ACCESSORIES PROVIDED WITH THE UNIT. REFER TO THE DESCRIPTIONS PROVIDED UNDER THE "ACCESSORIES" NOTES ON THIS PAGE.

FEATURE	NAME	DEFAULT SETTING
1C	NORMAL SOURCE FAILURE TO ENGINE START	1 sec
2B	TRANSFER TO EMERGENCY ON AVAILABILITY OF EMERGENCY SOURCE	0 sec
1F	EMERGENCY SOURCE FAILURE RETRANSFER (NORMAL SOURCE AVAILABLE)	0 sec
2E	ENGINE COOLDOWN FOLLOWING RETRANSFER TO NORMAL	5 min
3A	RETRANSFER TO NORMAL (NORMAL FAILURE MODE)	30 min
3A	RETRANSFER TO NORMAL (TEST MODE)	30 sec
-	DELAYED TRANSFER (LOAD "OFF" TIME), [0-5 min 59 sec]	3 sec

DESCRIPTIONS OF TIME DELAYS:

- FEAT. 1C - DELAY ON NORMAL SOURCE OUTAGE. STARTS ON FAILURE OF NORMAL SOURCE. RESETS IF NORMAL SOURCE IS ACCEPTED BEFORE EXPIRATION. INHIBITS ENGINE STARTING AND AUTOMATIC TRANSFER UNTIL EXPIRATION.
- FEAT. 2B - DELAY PRIOR TO TRANSFER TO THE EMERGENCY SOURCE. DELAY STARTS ON EXPIRATION OF FEAT. 1C AND WHEN THE EMERGENCY SOURCE HAS BEEN ACCEPTED. DELAY RESETS IF THE EMERGENCY SOURCE FAILS PRIOR TO EXPIRATION. ON EXPIRATION, TRANSFER TO EMERGENCY IS INITIATED UNLESS THE NORMAL SOURCE HAS RECOVERED AND THE "COMMIT TO TRANSFER" FEATURE IS SET TO "NO" COMMIT. PROVIDES A PERIOD FOR EMERGENCY SOURCE STABILIZATION OR STAGING OF MULTIPLE TRANSFER SWITCH CONTROLLED LOADS TO THE EMERGENCY SOURCE.
- FEAT. 1F - DELAY ON RETRANSFER TO NORMAL IN THE EVENT OF EMERGENCY SOURCE FAILURE. DELAY BEGINS ON FAILURE OF THE EMERGENCY SOURCE IF THE NORMAL SOURCE IS ACCEPTABLE. ON EXPIRATION, RETRANSFER TO NORMAL WILL BE INITIATED.
- FEAT. 2E - DELAY ON ENGINE SHUTDOWN (ENGINE COOL DOWN PERIOD). DELAY STARTS FOLLOWING RETRANSFER TO THE NORMAL SOURCE. PROVIDES A PERIOD FOR THE ENGINE-GENERATOR SET TO RUN UNLOADED PRIOR TO SHUTDOWN.
- FEAT. 3A - RETRANSFER TO NORMAL DELAY (NORMAL FAILURE MODE)
DELAY STARTS WHEN NORMAL SOURCE IS ACCEPTED (FOLLOWING IT'S FAILURE) AND WHILE THE LOAD IS CONNECTED TO EMERGENCY. RESETS IF NORMAL FAILS PRIOR TO EXPIRATION OR IF THE EMERGENCY SOURCE FAILS BEFORE EXPIRATION AND FEAT. 1F EXPIRES (AUTOMATIC BYPASS ON EMERGENCY SOURCE FAILURE). PROVIDES A PERIOD FOR THE NORMAL SOURCE TO STABILIZE PRIOR TO RETRANSFER.
- FEAT. 3A - RETRANSFER TO NORMAL DELAY (TEST MODE)
DELAY STARTS WHEN THE "TRANSFER TEST" SWITCH IS RESET TO "AUTO" (FOLLOWING A USER INITIATED TRANSFER TEST) AND WHILE THE LOAD IS CONNECTED TO EMERGENCY. RESETS IF NORMAL FAILS PRIOR TO EXPIRATION OR IF THE EMERGENCY SOURCE FAILS BEFORE EXPIRATION AND FEAT. 1F EXPIRES (AUTOMATIC BYPASS ON EMERGENCY SOURCE FAILURE).

DELAYED TRANSFER (LOAD "OFF" TIME) - PROVIDES A USER DEFINABLE PERIOD DURING WHICH THE LOAD IS DISCONNECTED FROM BOTH THE NORMAL AND EMERGENCY SOURCES DURING TRANSFER IN EITHER DIRECTION. THE DELAY ("OFF" PERIOD) BEGINS FOLLOWING THE OPENING OF THE SOURCE CONTACTOR, CN OR CE, CONNECTED TO THE SOURCE FROM WHICH TRANSFER IS BEING MADE. UPON EXPIRATION, CLOSURE OF THE OPPOSITE SOURCE CONTACTOR IS INITIATED.

ENGINE EXERCISER

THE ENGINE EXERCISER FEATURE PROVIDES A MEANS TO PERFORM AUTOMATIC EXERCISING OF THE ENGINE-GENERATOR SET EITHER WITH OR WITHOUT LOAD TRANSFER. THE USER CAN PROGRAM UP TO SEVEN DIFFERENT EXERCISE ROUTINES. EACH ROUTINE INCLUDES:

1. ENABLE OR DISABLE THE ROUTINE
2. ENABLE OR DISABLE TRANSFER OF THE LOAD DURING THE ROUTINE
3. SET START TIME OF ROUTINE -
- TIME OF DAY
- DAY OF WEEK
- WEEK OF MONTH (1st, 2nd, 3rd, 4th, ALTERNATE OR ALL)
4. SET THE DURATION OF THE ROUTINE

PARAMETER	RANGE OF SETTING	DEFAULT SETTING
MONTH (CLOCK SET)	JAN FEB MAR APR MAY JUN JUL AUG SEP OCT NOV DEC	CURRENT DATE
DAY	1-31	↓
YEAR	00-99	Eastern Standard Time
HOUR	0-23	↓
MINUTE	0-59	↓
ENABLE ROUTINE (ROUTINE 1-7)	YES/NO	NO
TRANSFER LOAD	YES/NO	NO
START HOUR	0-23	0
START MINUTE	0-59	0
RUN WEEK	ALL, ALTERNATE, 1st, 2nd, 3rd, 4th, 5th	ALL
RUN DAY	SUN MON TUE WED THU FRI SAT	SUN
DURATION HOURS	0-23	0
DURATION MINUTES	0-59	0

SIGNALS & AUXILIARIES

A. FEATURES 7 & 8- ENGINE START SIGNAL

SIGNAL INITIATED BY DROPOUT OF CONTROL PANEL RELAY (NR) FOLLOWING EXPIRATION OF THE FEATURE 1C TIME DELAY (DELAY TO OVERRIDE MOMENTARY NORMAL SOURCE OUTAGES). FEATURE 7 CLOSURES TO SIGNAL ENGINE START. FEATURE 8 OPENS TO SIGNAL ENGINE START. ENGINE STARTING SIGNAL RESETS FOLLOWING RETRANSFER TO THE NORMAL SOURCE AND EXPIRATION OF THE FEATURE 2E (ENGINE COOL DOWN) TIME DELAY. FEATURES 7 & 8 ARE PROVIDED AS A SINGLE FORM C CONTACT CONNECTED TO THE FIELD CONNECTIONS TERMINAL BLOCK (TB). CONTACT RATED 10 AMPS AT 32 VDC/120 VAC RESISTIVE.

B. FEATURES 14AG & 14BG - TRANSFER SWITCH AUXILIARY POSITION INDICATING CONTACTS. EIGHT (8) FORM A CONTACTS EACH TO INDICATE CONNECTION OF THE TRANSFER SWITCH TO NORMAL (14A) OR EMERGENCY (14B). CONTACTS CONNECTED TO THE FIELD CONNECTIONS TERMINAL BLOCK (TB). CONTACTS RATED 10 AMPS, 32 VDC, 250 VAC.

C. FEATURE 17 - REMOTE TRANSFER TO EMERGENCY. REQUIRES A CUSTOMER SUPPLIED NORMALLY OPEN CONTACT. CLOSING OF THE CONTACT CAUSES ENGINE START AND TRANSFER TO THE EMERGENCY SOURCE. OPENING OF THE CONTACT ACTIVATES THE FEATURE 3A (RETRANSFER TO NORMAL) DELAY PRIOR TO RETRANSFER. IN THE EVENT THE EMERGENCY SOURCE FAILS WHILE THE TRANSFER SWITCH IS CONNECTED TO EMERGENCY AND THE REMOTE CONTACT IS CLOSED, THE TRANSFER SWITCH WILL RETRANSFER TO THE NORMAL SOURCE. CONNECTED TO THE FIELD CONNECTIONS TERMINAL BLOCK (TB).

OPERATION

IF THE NORMAL SOURCE FAILS, THE TRANSFER SWITCH INITIATES STARTING OF THE ENGINE-GENERATOR SET. WHEN PROPER VOLTAGE AND FREQUENCY HAVE BEEN ATTAINED, THE LOAD WILL BE TRANSFERRED TO THE EMERGENCY SOURCE BY MEANS OF A DELAYED TRANSITION, (PROGRAMMED LOAD DISCONNECT PERIOD).

DELAYED TRANSITION TRANSFER TO EMERGENCY WILL CAUSE THE NORMAL SOURCE CONTACTOR (CN) TO OPEN. AFTER THE LOAD DISCONNECT DELAY, AS SET VIA THE USER INTERFACE OF THE GROUP 5 CONTROL PANEL, THE EMERGENCY SOURCE CONTACTOR (CE) WILL CLOSE. DURING THE PERIOD THAT BOTH CONTACTORS ARE OPEN AND THE TIME DELAY IS ACTIVE, A "LOAD DISCONNECT ACTIVE" LED WILL BE LIT (AMBER LED).

WHEN THE NORMAL SOURCE IS RESTORED FOR THE DURATION OF THE FEATURE 3A, RETRANSFER TO NORMAL TIME DELAY SETTING, THE LOAD WILL BE RETRANSFERRED TO THE NORMAL SOURCE IN A DELAYED TRANSITION MANNER.

DELAYED TRANSITION RETRANSFER TO NORMAL WILL CAUSE THE EMERGENCY SOURCE CONTACTOR (CE) TO OPEN. AFTER THE LOAD DISCONNECT TIME DELAY EXPIRES, THE NORMAL SOURCE CONTACTOR (CN) WILL CLOSE.

THE ENGINE WILL CONTINUE TO RUN FOR THE ENGINE COOL DOWN PERIOD, FEATURE 2E.

DELAYED TRANSITION TRANSFER WILL ALSO OCCUR DURING TRANSFER TO EMERGENCY BY OPERATING THE TEST SWITCH. RETRANSFER TO NORMAL WILL OCCUR AS PREVIOUSLY DESCRIBED.

USER CONTROLS AND INDICATIONS

A. FEATURES 5 & 6B - TRANSFER TEST/RETRANSFER TIME DELAY BYPASS CONTROLS.

TRANSFER TEST:

OPERATION CAUSES A NORMAL SOURCE FAILURE SEQUENCE. ACTIVATE AND HOLD FOR AT LEAST 15 SECONDS TO ALLOW TIME FOR THE ENGINE-GENERATOR TO START.

RETRANSFER TIME DELAY BYPASS:

OPERATION WILL BYPASS THE FEATURE 3A (RETRANSFER TO NORMAL DELAY).

B. FEATURES 9A & 9B - TRANSFER SWITCH POSITION INDICATORS.

FEATURE 9A: TRANSFER SWITCH CLOSED ON NORMAL (GREEN LED)
FEATURE 9B: TRANSFER SWITCH CLOSED ON EMERGENCY (RED LED)

C. FEATURES 9C & 9D - SOURCE ACCEPTANCE INDICATORS.

FEATURE 9C: NORMAL SOURCE ACCEPTED (GREEN LED)
FEATURE 9D: EMERGENCY SOURCE ACCEPTED (RED LED)

D. LOAD DISCONNECT ACTIVE - INDICATES THAT THE TRANSFER SWITCH IS IN THE LOAD DISCONNECTED POSITION (BOTH NORMAL (CN) AND EMERGENCY (CE) CONTACTORS OPEN) (AMBER LED).

GENERAL NOTES

1. SWITCH SHOWN DE-ENERGIZED AND CONNECTED TO THE NORMAL SOURCE.
2. DEVICE SYMBOLS AND DESIGNATIONS ARE IN ACCORDANCE WITH NEMA PUBLICATION ICS 1-1983, PART 1-101A.
3. ALL WIRING IS #16 AWG, TINNED, STRANDED COPPER UNLESS OTHERWISE INDICATED.
4. ○ ON TERMINAL BLOCKS INDICATES AVAILABLE FIELD CONNECTION POINT.
5. ● ON TERMINAL BLOCKS INDICATES FACTORY CONNECTION POINT.
6. CONTROL AND ACCESSORY WIRING IS ROUTED IN ACCORDANCE WITH ASCO ASSEMBLY PROCEDURE GS451261.
7. AN OPERATOR'S MANUAL IS FURNISHED WITH EACH AUTOMATIC TRANSFER SWITCH. REFER TO THIS PUBLICATION PRIOR TO INSTALLATION AND OPERATION OF THE UNIT.

BASE CATALOG NUMBER				CATALOG NUMBER SUFFIXES				EXPLANATION OF CATALOG NUMBER CODES										
TS FRAME	CATALOG TYPE	NEUTRAL TYPE	PHASE POLES	AMPS	VOLT CODE	CONTROLLER	OPTIONAL ACCESSORY	ENCLOSURE CODE	NEUTRAL TYPE		VOLTAGE CODES 3 PHASE (3 OR 4 WIRE) 50 OR 60 Hz		ENCLOSURE CODES					
									CODE	DESCRIPTION	CODE	NOMINAL VOLTAGE	CODE	TYPE	DESCRIPTION			
									BLANK A B	NONE SOLID SWITCHING	C D E F	208 220 230 240	BLANK C	1	OPEN TYPE (NO ENCLOSURE)			
											H J K L M N P Q R	380 400 415 440 460 480 550 575 600	J K L M N P Q	2 3R 4 4X 7 12	GENERAL PURPOSE, INDOOR INDOOR, WATER & DUST RESISTANT OUTDOOR, RAINPROOF, SLEET & ICE RESISTANT INDOOR/OUTDOOR, WATERTIGHT & DUST TIGHT TYPE 4 PLUS CORROSION RESISTANCE (STAINLESS STEEL) TYPE 4 PLUS CORROSION RESISTANCE (FIBERGLASS) EXPLOSION PROOF INDOOR, INDUSTRIAL ENVIRONMENTS, OIL TIGHT & DUST TIGHT			
													M N P Q	3R 4 4X 12	(SECURE ENCLOSURES) OUTDOOR, RAINPROOF, SLEET & ICE RESISTANT INDOOR/OUTDOOR, WATERTIGHT & DUSTTIGHT TYPE 4 PLUS CORROSION RESISTANCE (STAINLESS STEEL) INDOOR, INDUSTRIAL ENVIRONMENTS, OILTIGHT & DUSTTIGHT			

CATALOG NUMBER _____
CERTIFIED TO

ASCO® S.O. _____

BY _____

DATE _____

FORM REV C

PROJECT NAME: _____

WIRING _____ DIAGRAM _____

7000 SERIES (H7ADTS)

GROUP 5 CONTROLS

MANUFACTURING TOLERANCES TO BE IN ACCORDANCE WITH ASCO PROCEDURE MP-1-003. FOR PLASTIC PARTS SEE MP-1-055

ASSEM. REF. NO. _____

PROPERTY OF ASCO POWER TECHNOLOGIES. USE PERMITTED FOR OUR WORK ONLY. ALL RIGHTS OF DESIGN OR INVENTION ARE RESERVED.

SCALE 1:1 ACAD FILE

SIZE DWG. NO. DS713505

CHANGE C ECH NO. 166900 SHEET 1 OF 6

166900 SDH SDH 04/26/04

SEE ECN

160049 WK WK 03/04/02

SEE ECN

158293 BWM WK 7/24/01

SEE ECN

156547 SDH SDH 01/01

ISSUE

CHANGE LETTER ECN NO. BY APP. DATE

SUBSIDIARY DISTRIBUTION

AE AN AM AJ AL

CH AV AA PS AR

AG AP AC AS

COMPUTER GENERATED DRAWING

SCALE 1:1 ACAD FILE

SIZE DWG. NO. DS713505

CHANGE C ECH NO. 166900 SHEET 1 OF 6

FIELD CONNECTIONS

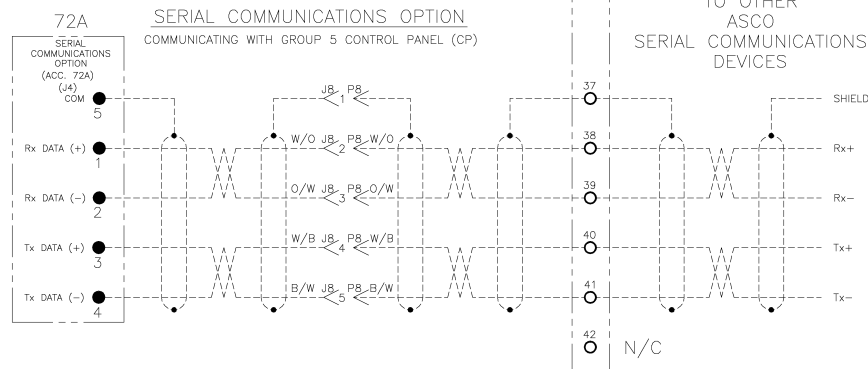
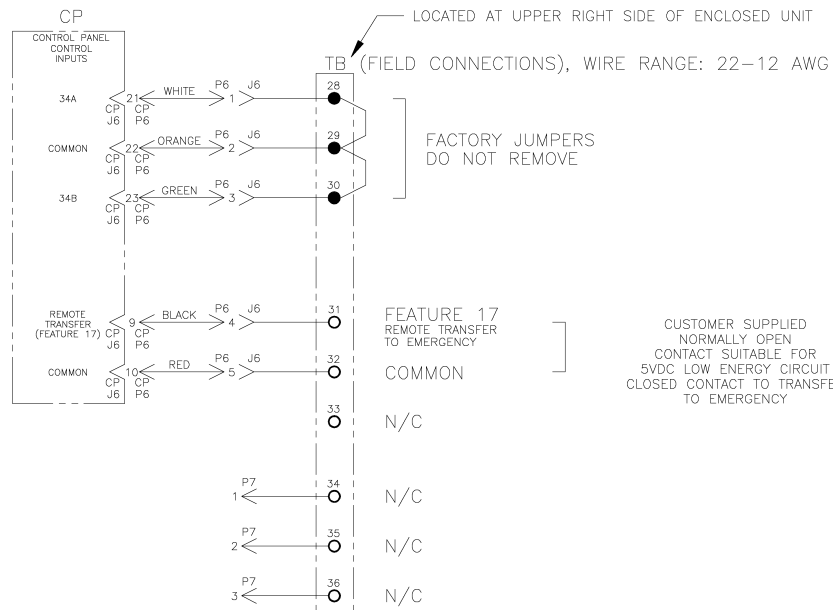
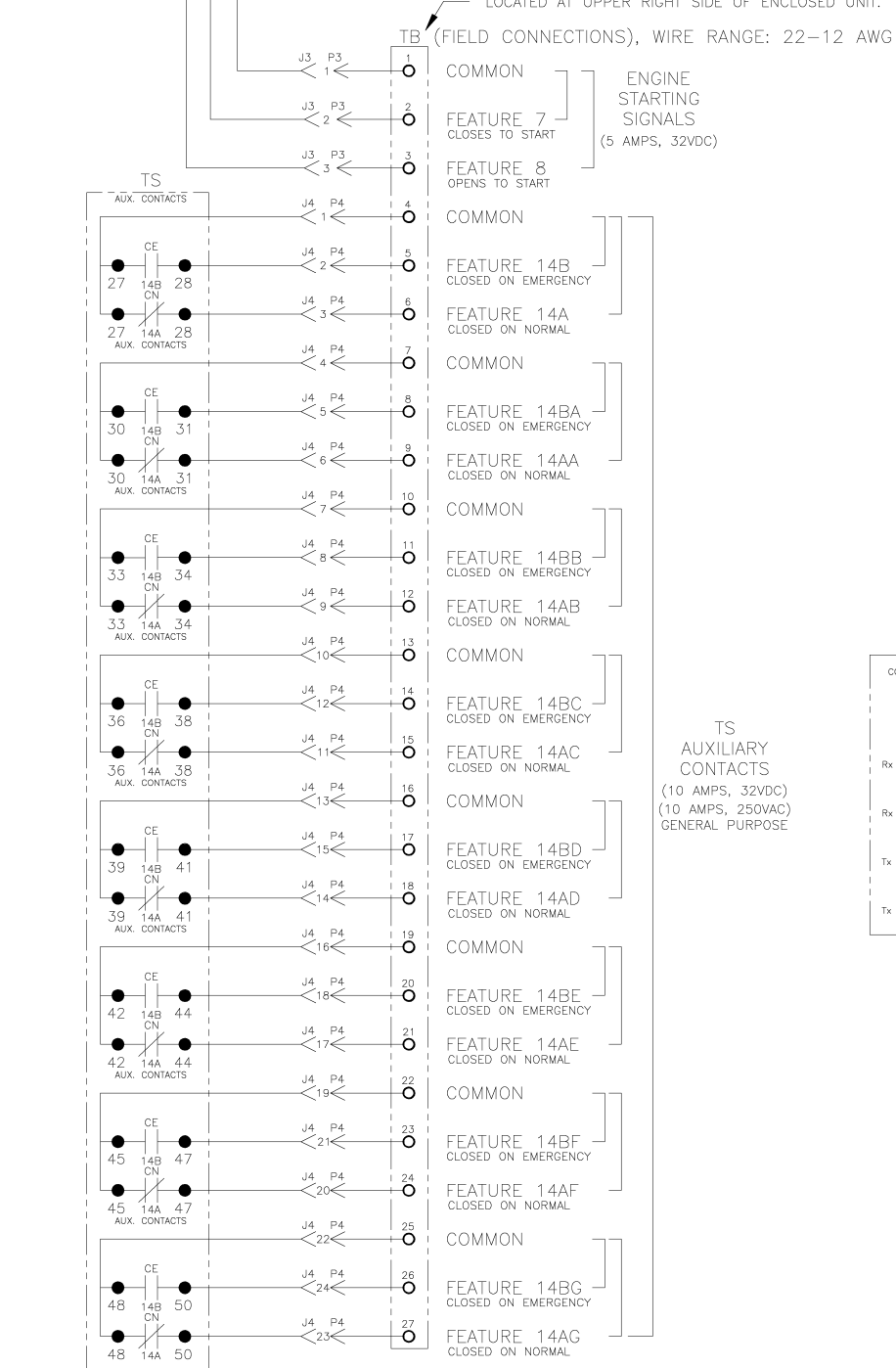
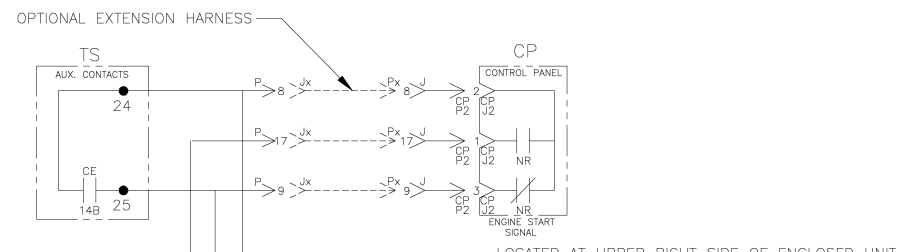

C	166900	SDH	SDH	04/26/04
	SEE ECN			
B	160049	WK	WK	03/04/02
	SEE ECN			
A	158293	BWM	WK	7/24/01
	SEE ECN			
	156547	SDH	SDH	01/01
	ISSUE			
CHANGE LETTER	ECN NO.	BY	APP.	DATE

PROJECT NAME: WIRING DIAGRAM

7000 SERIES (H7ADTS) GROUP 5 CONTROLS

THIRD ANGLE PROJECTION

MANUFACTURING TOLERANCES TO BE IN ACCORDANCE WITH ASCO PROCEDURE MP-1-003. FOR PLASTIC PARTS SEE MP-1-055

ASCO POWER TECHNOLOGIES, L.P.
FLORHAM PARK, NEW JERSEY 07932 U.S.A.

SCALE: 1:1 ACAD FILE

SIZE: DWG. NO. DS713505

CHANGE LETTER C ECN NO. 166900 SHEET 2 OF 6

EMERGENCY

NORMAL

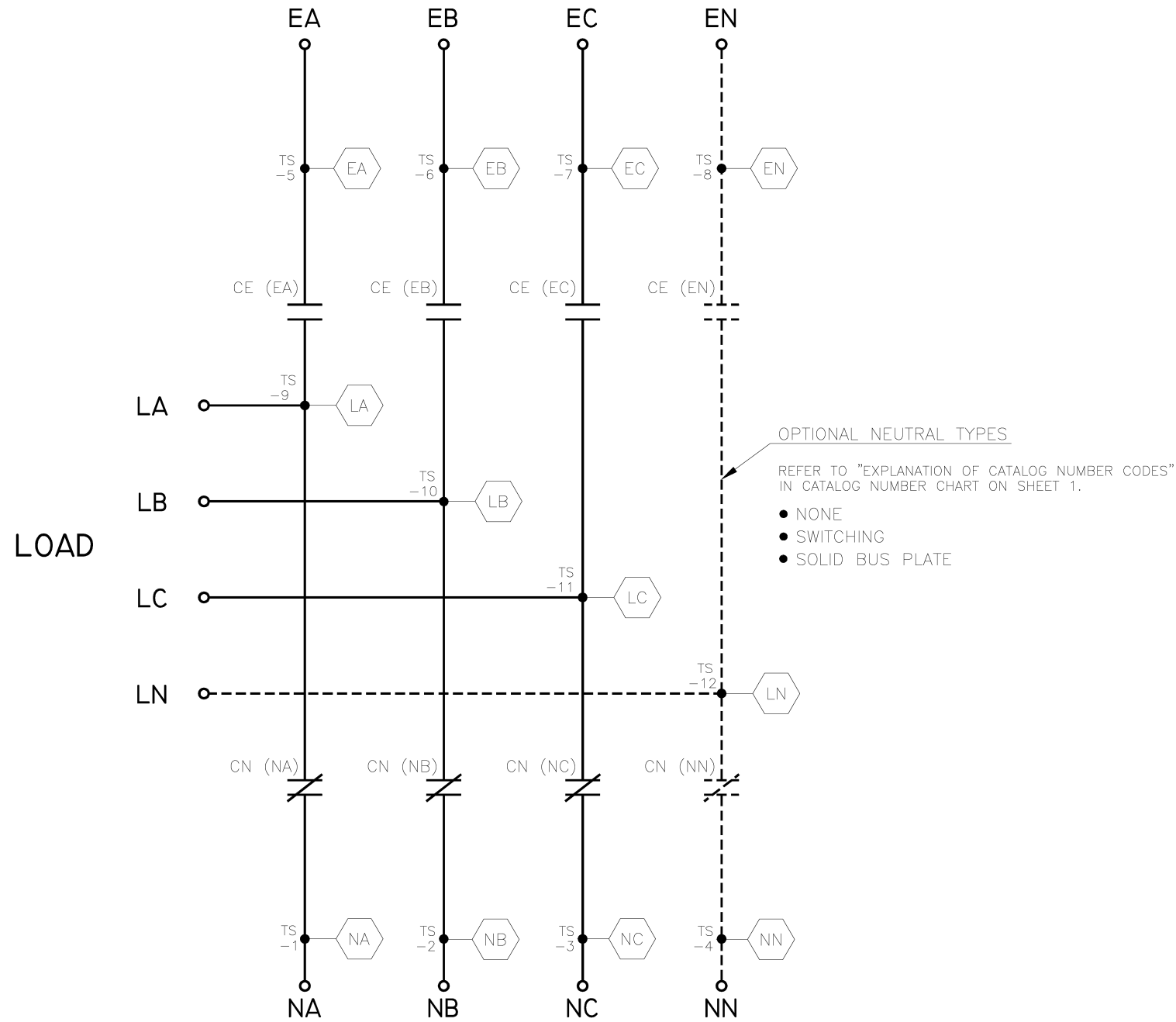

OPTIONAL NEUTRAL TYPES
 REFER TO "EXPLANATION OF CATALOG NUMBER CODES" IN CATALOG NUMBER CHART ON SHEET 1.

- NONE
- SWITCHING
- SOLID BUS PLATE

NOTE:
 ATS SHOWN CLOSED ON NORMAL SOURCE.

NORMAL

EMERGENCY

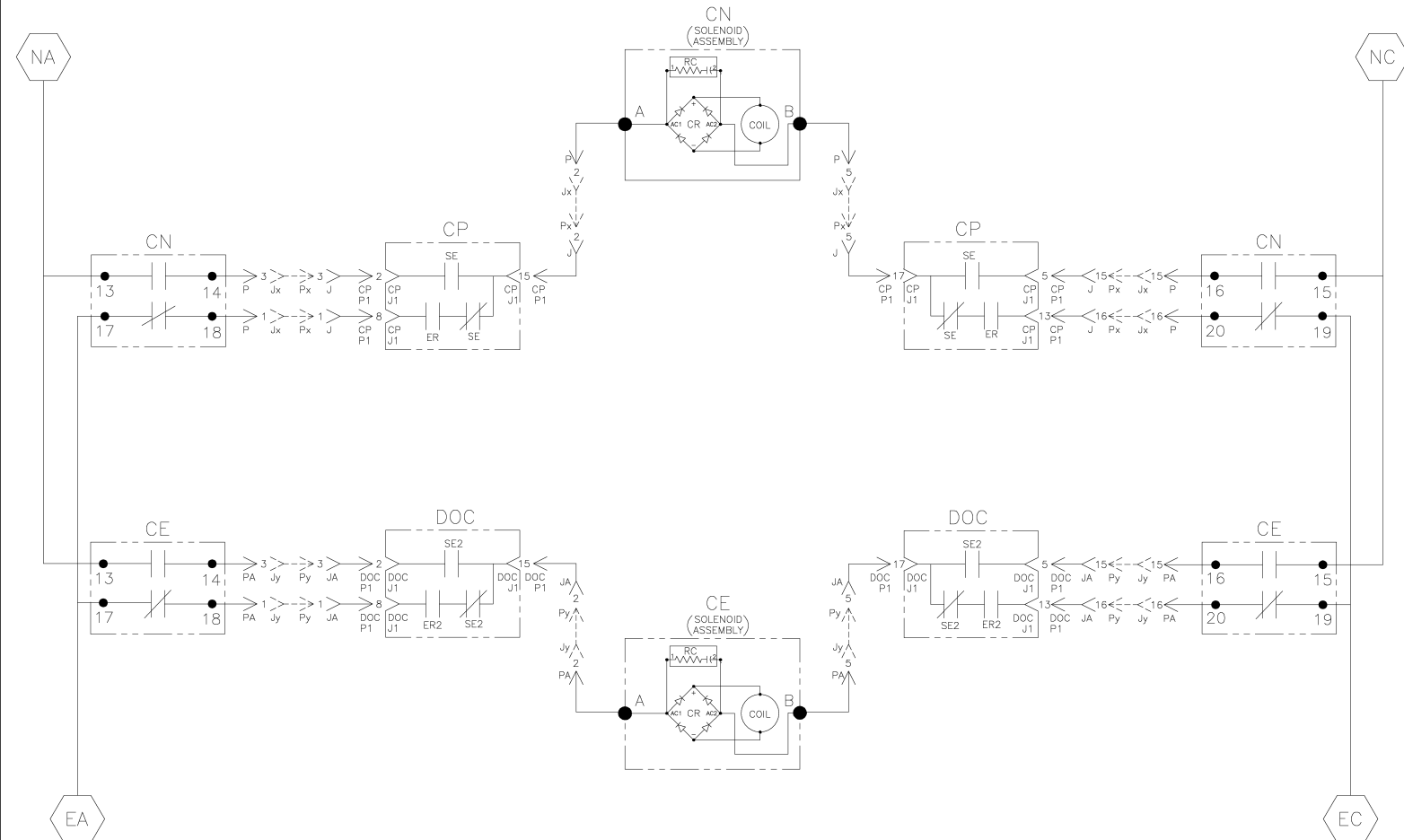

CN	SOLENOID POSITION			
	CLOSED BEFORE NORMAL TDC*	BEFORE TDC*	BEFORE TDC*	OPEN
13-14				
15-16				
17-18				
19-20				

CE	SOLENOID POSITION			
	OPEN	BEFORE TDC*	BEFORE TDC*	CLOSED BEFORE EMERG.
13-14				
15-16				
17-18				
19-20				

TDC (TOP DEAD CENTER)
 TRANSFER SWITCH TEST & ADJUSTMENT PROCEDURE
 SPECIFIES CONTROL CUT-OFF (CONTACT OPENING) SETTING.

PROJECT NAME: WIRING DIAGRAM
 7000 SERIES (H7ADTS)
 GROUP 5 CONTROLS

THIRD ANGLE PROJECTION

ASCO POWER TECHNOLOGIES, L.P.
 FLORHAM PARK, NEW JERSEY 07932 U.S.A.

SCALE	1:1	ACAD	FILE
SIZE	DWG. NO. DS713505		
CHANGE LETTER	C	ECN NO.	166900
		SHEET	3 OF 6

C	166900	SDH	SDH	04/26/04
B	160049	WK	WK	03/04/02
A	158293	BWM	WK	7/24/01
	156547	SDH	SDH	01/01

EMERGENCY SOURCE CIRCUITS

ADDITIONAL CIRCUITS

EMERGENCY

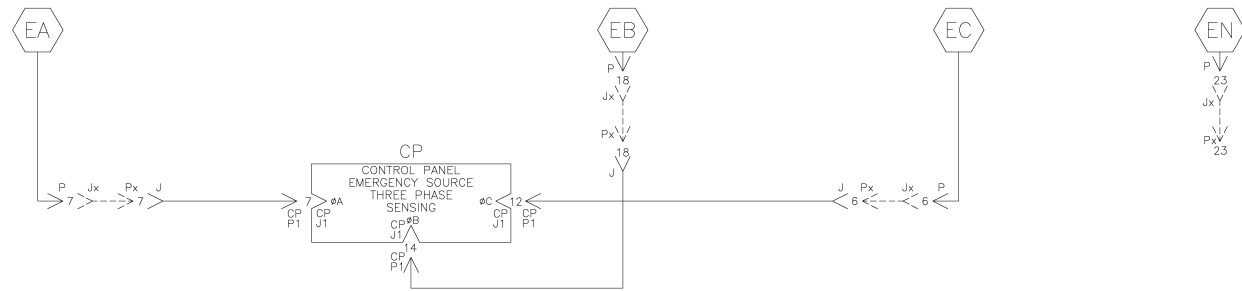

LOAD TERMINAL CIRCUITS

LOAD



NORMAL SOURCE CIRCUITS

NORMAL

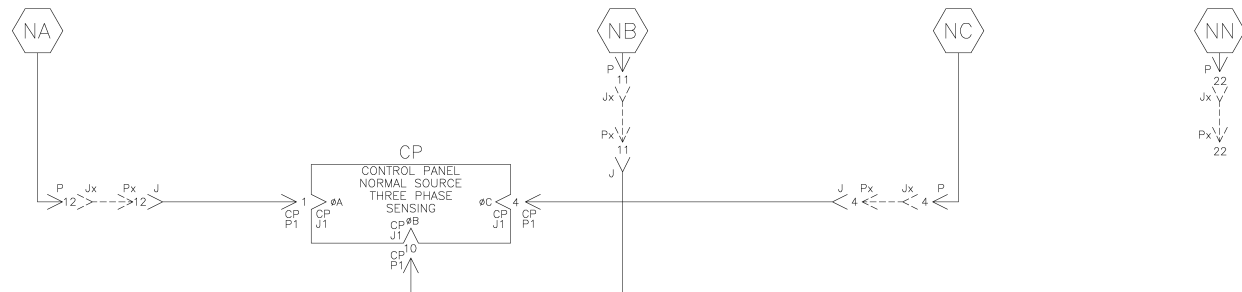

CONTROL CIRCUITS

SER2/ER2 CONTROL

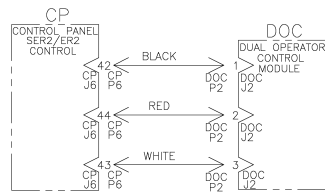

TS POSITION SENSING

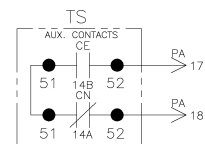
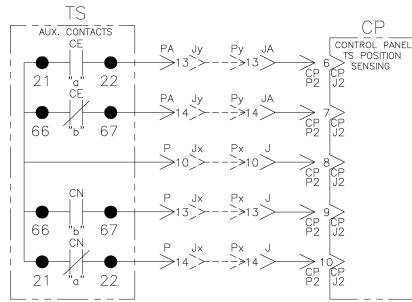

SPARE FOR FACTORY USE

C	166900	SDH	SDH	04/26/04
	SEE ECN			
B	160049	WK	WK	03/04/02
	SEE ECN			
A	158293	BWM	WK	7/24/01
	SEE ECN			
	156547	SDH	SDH	01/01
	ISSUE			

PROJECT NAME:		WIRING DIAGRAM		THIRD ANGLE PROJECTION	
DRAWN BY: SDH		DATE: 01/01		ASSEM. REF. NO.	
CHECKED:		DRAFTING APPROVAL:		SCALE: 1:1	
FINAL APPROVAL: SDH		DATE: 01/01		SIZE: DWG. NO. DS713505	
PROPERTY OF ASCO POWER TECHNOLOGIES. USE PERMITTED FOR OUR WORK ONLY. ALL RIGHTS OF DESIGN OR INVENTION ARE RESERVED.		ASCO POWER TECHNOLOGIES, L.P. FLORHAM PARK, NEW JERSEY 07932 U.S.A.		SHEET 4 OF 6	

PHYSICAL DIAGRAM

ENCLOSURE

DOOR (INSIDE)

TS (TRANSFER SWITCH)
VIEW FROM INSIDE FRONT

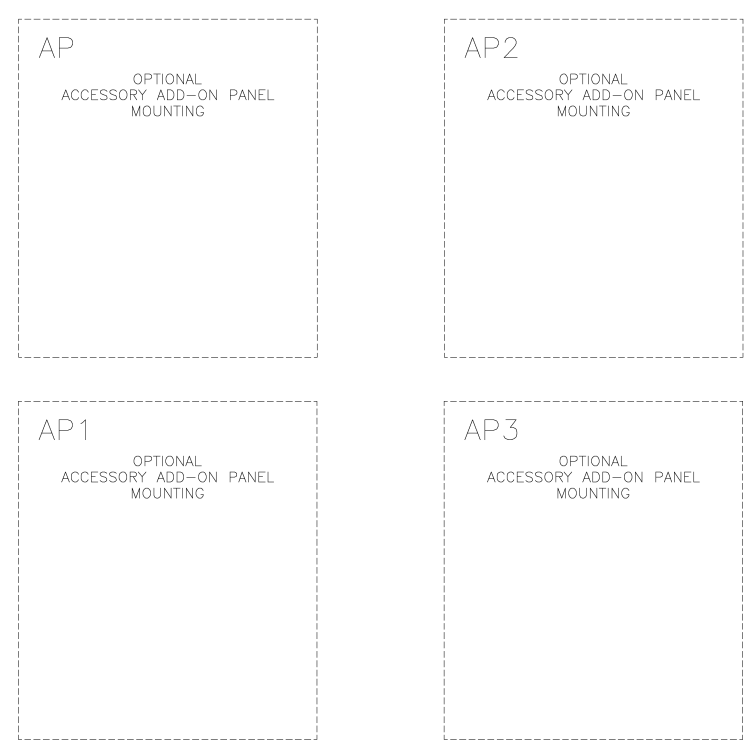
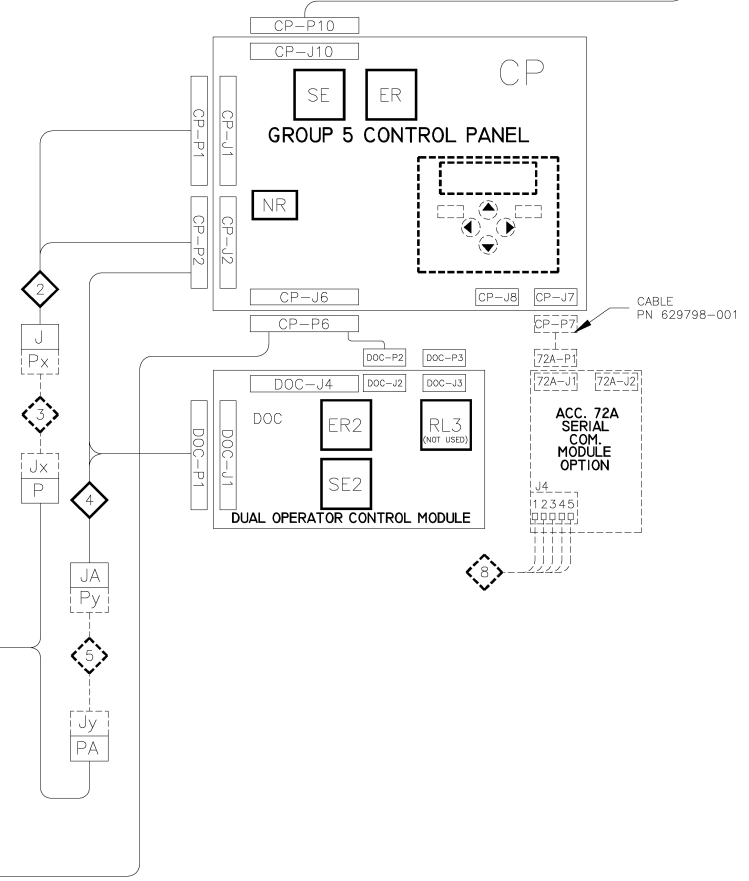
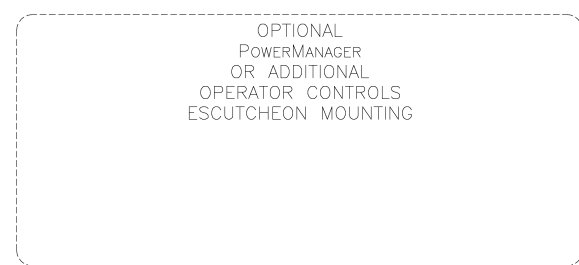
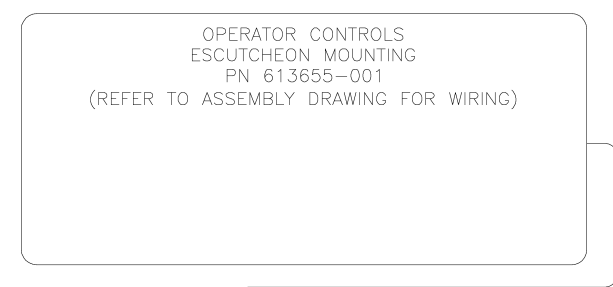
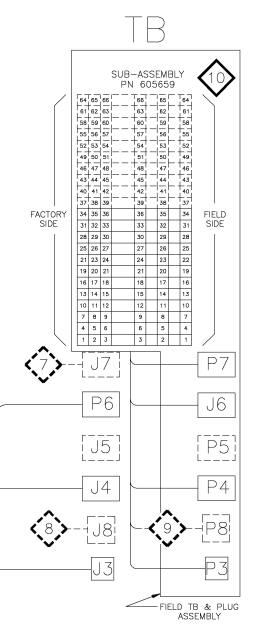
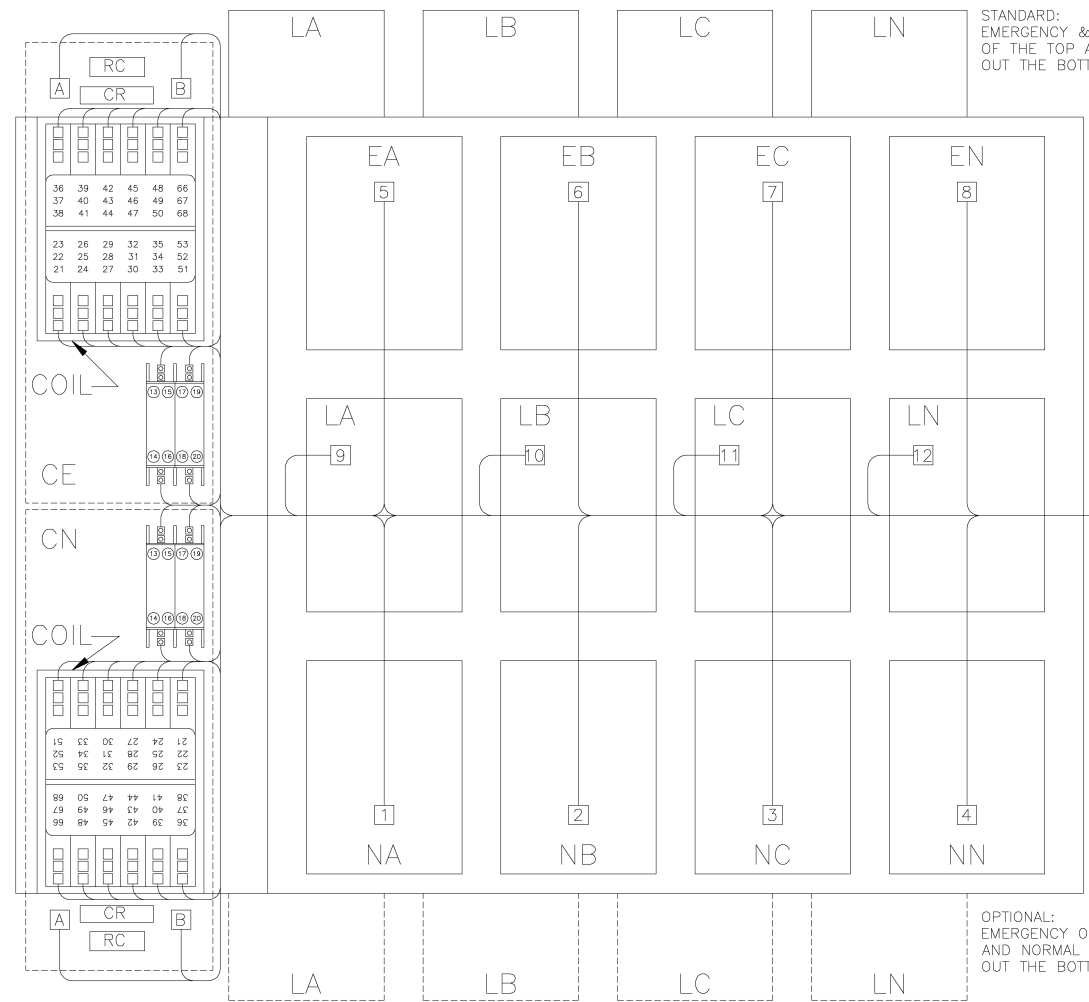

PROJECT NAME:		WIRING DIAGRAM		7000 SERIES (H7ADTS) GROUP 5 CONTROLS	
SCALE	1:1	ACAD	FILE	COMPUTER GENERATED DRAWING	
SIZE	DWG. NO.		DS713505		
CHANGE LETTER	C	ECN NO.	166900	SHEET	5 OF 6

C	166900	SDH	SDH	04/26/04
B	160049	WK	WK	03/04/02
A	158293	BWM	WK	7/24/01
	156547	SDH	SDH	01/01

AE	<input type="checkbox"/>	AN	<input type="checkbox"/>	AM	<input type="checkbox"/>	AJ	<input type="checkbox"/>	AL	<input type="checkbox"/>
CH	<input type="checkbox"/>	AV	<input type="checkbox"/>	AA	<input type="checkbox"/>	PS	<input type="checkbox"/>	AR	<input type="checkbox"/>
AG	<input type="checkbox"/>	AP	<input type="checkbox"/>	AC	<input type="checkbox"/>	AS	<input type="checkbox"/>		<input type="checkbox"/>

PROPERTY OF ASCO POWER TECHNOLOGIES. USE PERMITTED FOR OUR WORK ONLY. ALL RIGHTS OF DESIGN OR INVENTION ARE RESERVED.

ASCO POWER TECHNOLOGIES, L.P.
FLORHAM PARK, NEW JERSEY 07932 U.S.A.

WIRE RUN LISTING

Table 1: HARNESS LOCATOR 1. HARNESS 713081 (P,PA,J3,J4) MAIN TS. WIRE No. 1-131. CLR, AWG 16. Includes 'REMOVE WIRES' and 'ADD WIRES' sections.

Table 2: HARNESS LOCATOR 2. HARNESS 483763 (J,CP-P1,CP-P2) CONTROL PANEL. WIRE No. 1-18. CLR, AWG 16. Includes 'ADD WIRES' section.

Table 3: HARNESS LOCATOR 3. HARNESS 309320-005 OPTIONAL 8" EXTENSION HARNESS. WIRE No. 1-24. CLR, AWG 16.

Table 4: HARNESS LOCATOR 4. HARNESS 619385 (JA,CP-P2,DOC-P1) CONTROL MODULE. WIRE No. 107-130. CLR, AWG 16. Includes 'ADD WIRES' section.

Table 5: HARNESS LOCATOR 5. HARNESS 309320-005 OPTIONAL 8 IN. EXTENSION HARNESS. WIRE No. 107-130. CLR, AWG 16.

Table 6: HARNESS LOCATOR 6. HARNESS 619510-005 (P6) FIELD INPUTS. WIRE No. 49-72. CLR, AWG 16 (12 COND). Includes 'ADD WIRES' section.

Table 7: HARNESS LOCATOR 7. HARNESS (J7) OPTIONAL FIELD OUTPUTS. WIRE No. 73-96. CLR, AWG 16. Includes 'ADD WIRES' section.

Table 8: HARNESS LOCATOR 8. HARNESS 605454-005 (J8) OPTIONAL SERIAL I/O. WIRE No. 98-102. CLR, AWG 22 (4 COND). Includes 'ADD WIRES' section.

Table 9: HARNESS LOCATOR 9. HARNESS 605454-007 (P8,TB) OPTIONAL SERIAL I/O. WIRE No. 98-102. CLR, AWG 22 (4 COND). Includes 'ADD WIRES' section.

Table 10: HARNESS LOCATOR 10. SUB-ASSEMBLY 605659 (P3,P4,J6,P7,TB) STD. FIELD TB. WIRE No. 8-75. CLR, AWG 16. Includes 'JUMPERS' and 'ADD WIRES' sections.

Table 11: WIRE No. 132-134. ADDITIONAL WIRING. CLR, AWG 16. Includes BLK, WHT, RED, SHLD, WHT/ORG, ORG/WHT, WHT/BLU, BLU/WHT.

PROJECT NAME: WIRING DIAGRAM 7000 SERIES (H7ADTS) GROUP 5 CONTROLS. Includes drawing title, scale (1:1), date (01/01), and ASCO logo.

Revision table with columns: C, B, A. Includes revision numbers, descriptions, and dates.

Change letter table with columns: CHANGE LETTER, ECN NO., BY, APP., DATE. Includes ECN 166900 and date 04/26/04.