

# VAMP 210

Itemref	Quantity	Title/Name, designation, material, dimension etc	Article No./Reference
Designed by R.Vaahtera	Checked by	Approved by - date	Date 2003.01.01
VAMP Ltd P.O.Box 5 (Runsoirite 7 ) FIN-65381 VAASA FINLAND	Phone +358-6-212 1100 Fax +358-6-212 1105 email vampp@vamp.fi	Filename VAMP 210 - 5 A 7 A A A	Scale
		Drawing number Vd210.EN.001	Sheet 1/2
		Edition A	

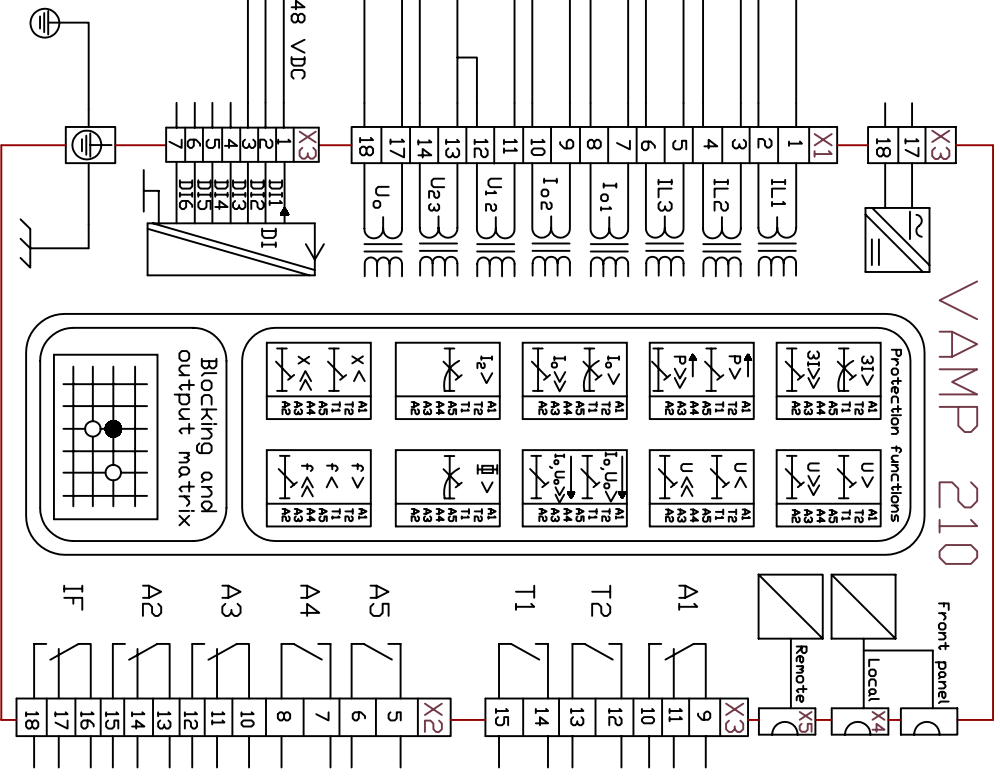

Itemref	Quantity	Title/Name, designation, material, dimension etc		Article No./Reference
Designed by R. Vaahterä	Checked by	Approved by - date	Title/Name	Date 2003.01.01
VAMP Ltd P.O.Box 5 (Runsorinte 7) FIN-65381 VAASA		Phone +358-6-212 1100 Fax +358-6-212 1105 email vampp@vamp.fi	Filename VAMP 210 - 5 A 7 A A A	Edition A
Drawing number VD210.EN.002				Sheet 2/2

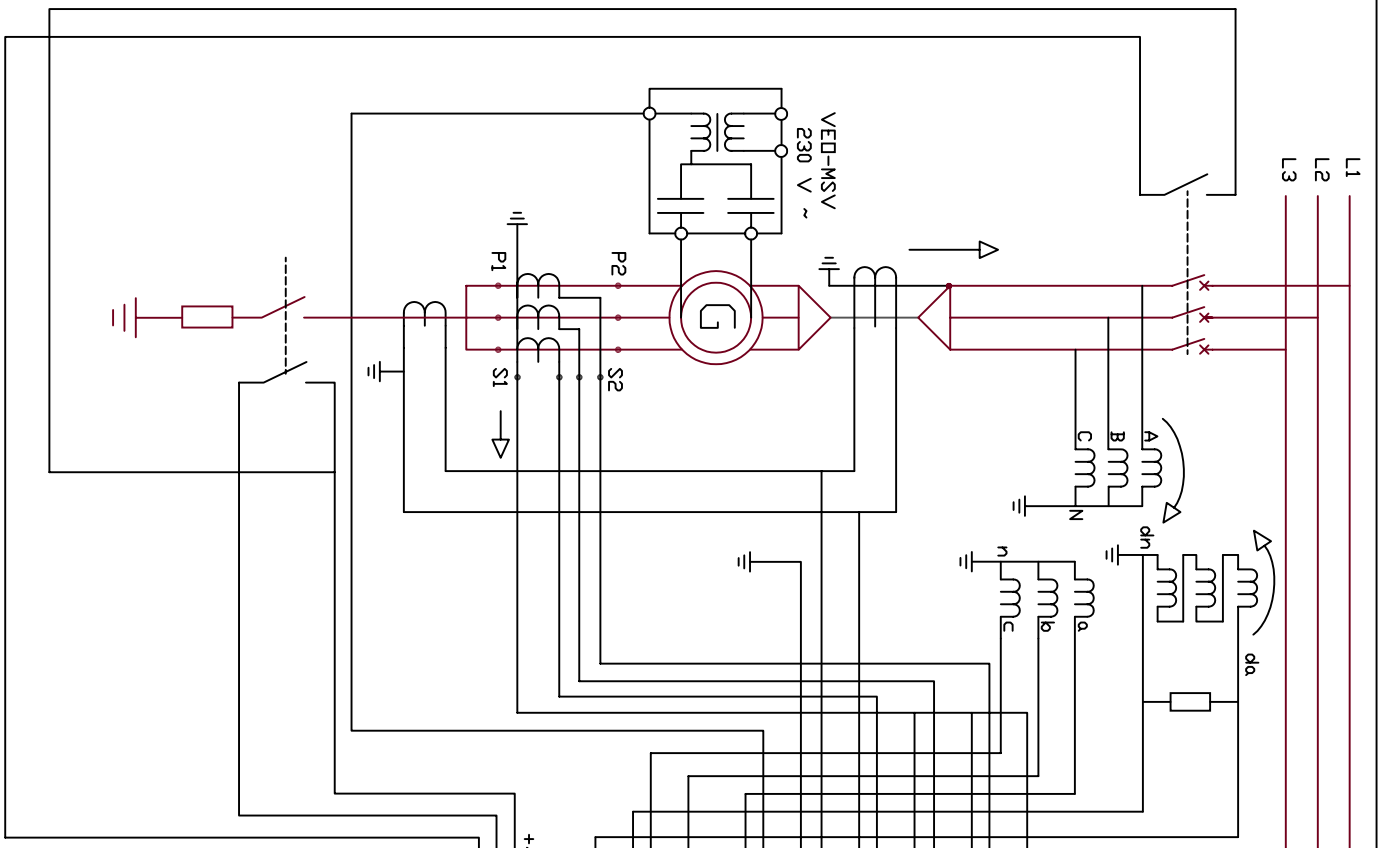
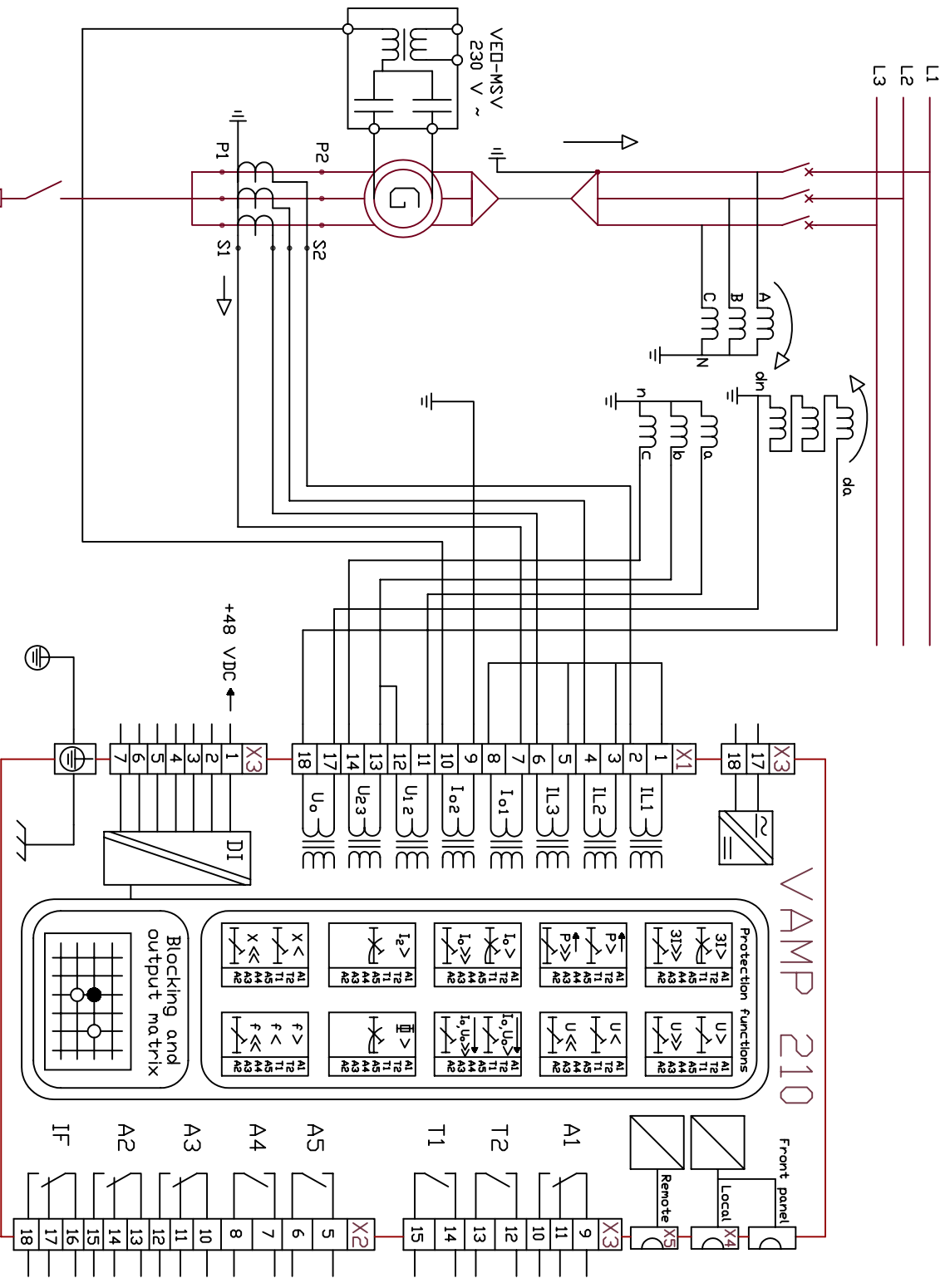

Itemref	Quantity	Title/Name, designation, material, dimension etc		Article No./Reference
Designed by R. Vaahterä	Checked by	Approved by -	date	Date 2003.03.27
VAMP Ltd P.O.Box 5 (Runsorinte 7) FIN-65381 VAASA		Phone +358-6-212 1100 Fax +358-6-212 1105 email vampp@vamp.fi		Filename VAMP 210 - 5 A 7 A A A Drawing number VD210.EN.003
FINLAND				Edition A
				Sheet 1/2

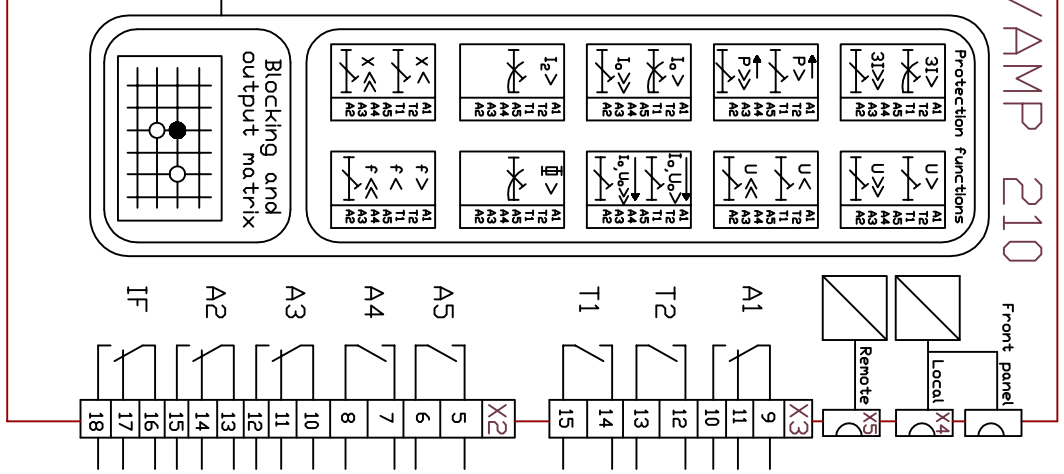
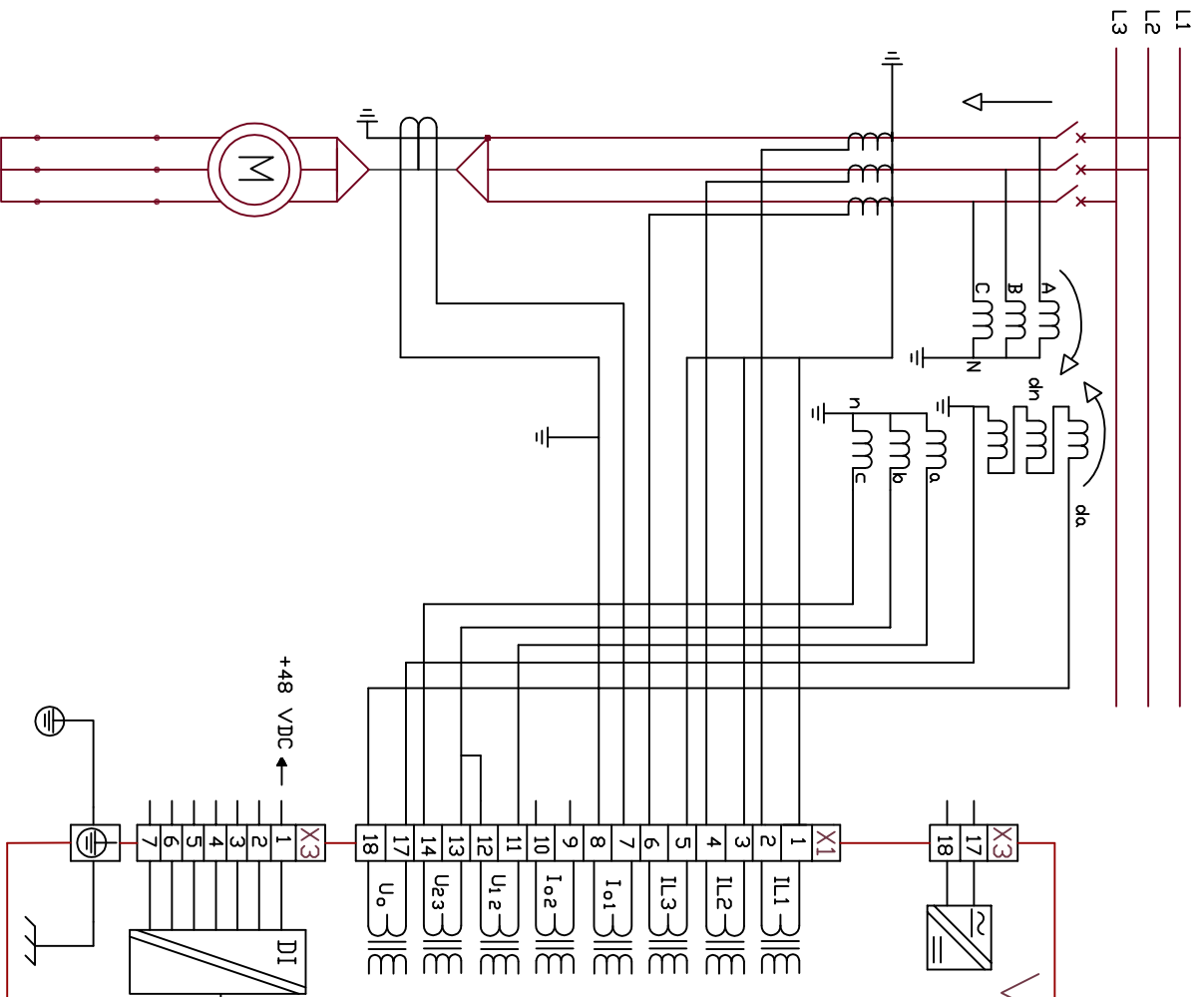

Itemref	Quantity	Title/Name, designation, material, dimension etc	Article No./Reference
Designed by R.Vaahterä	Checked by	Approved by - date	Title/Name Date 2008.06.23
<b>VAMP Ltd</b> P.O. Box 810 (Yrittäjänkatu 15) Phone +358 20 753 3200 FIN-65101 VAASA Fax +358 20 753 3205 email vamp@vamp.fi		File name VAMP 210 - 5 A 7 A A A - 4	Drawing number VD210.EN004
		Edition A	Sheet 1/1

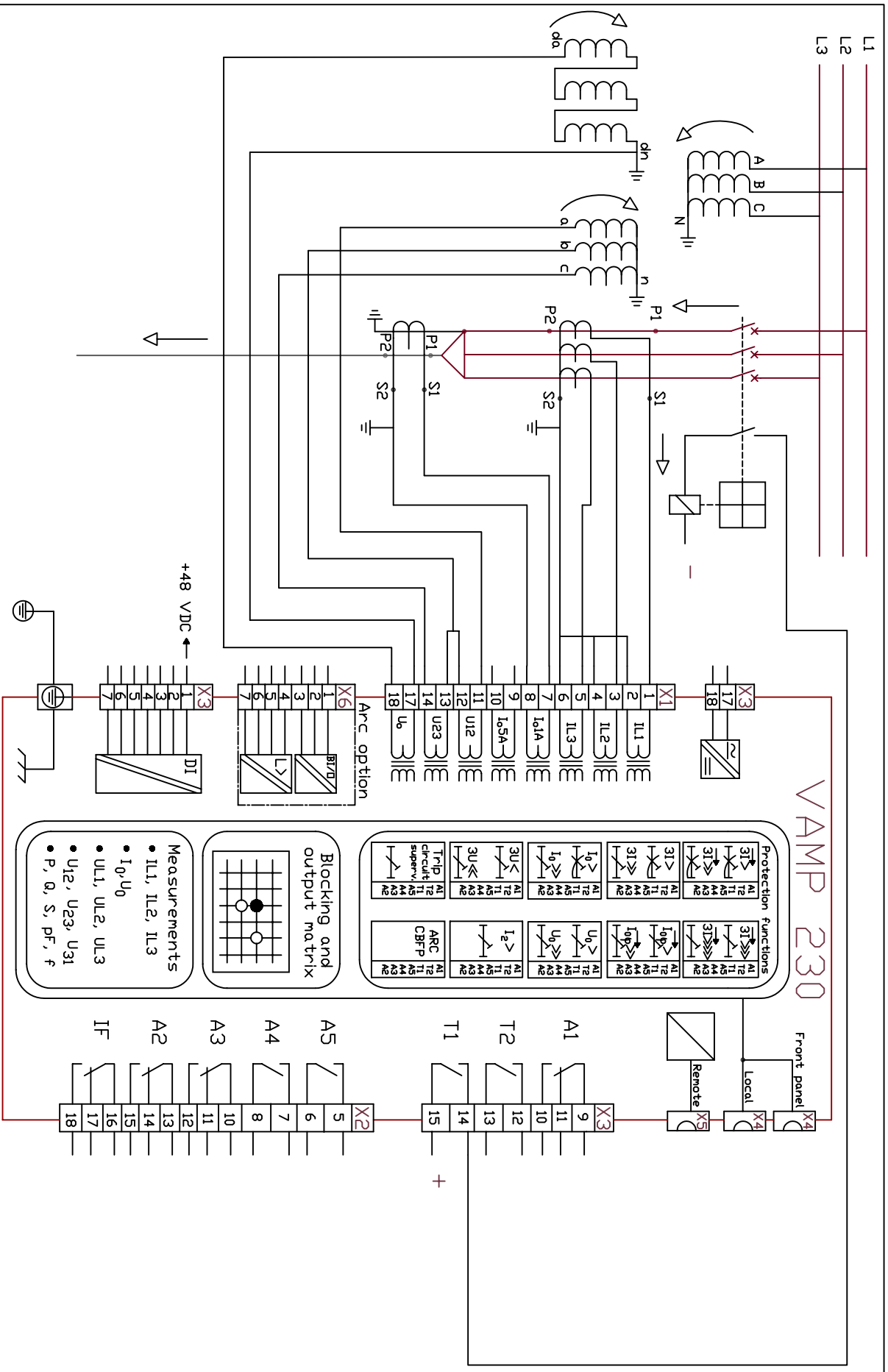

# VAMP 230

Mode: Line + U<sub>0</sub>

Itemref	Quantity	Title/Name, designation, material, dimension etc		Article No./Reference
Designed by R. Vaahterä	Checked by	Approved by - date	Title/Name	Date 2003.01.01
VAMP Ltd P.O.Box 5 (Runsorinte 7) FIN-65381 VAASA		Phone +358-6-212 1100 Fax +358-6-212 1105 email vampp@vamp.fi	Title/Name VAMP 230 - 3 C 7 C A A	Drawing number VD230.EN.001
FINLAND			Edition A	Sheet 1/4

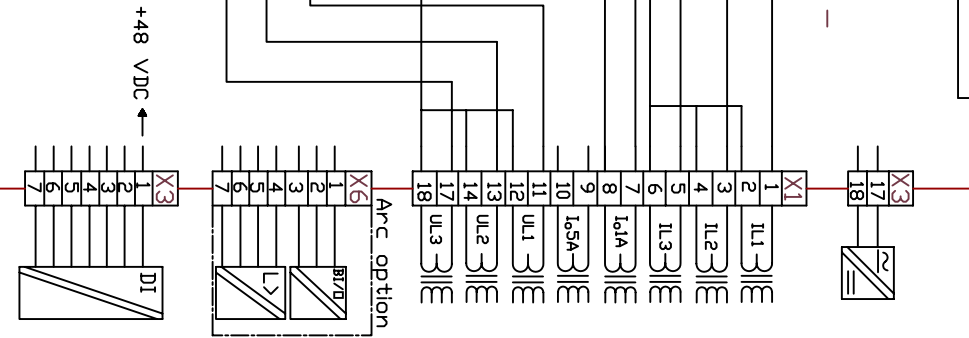

# VAMP 230

Protection functions

3I1	AI	TI	AI	3I1	AI	TI	AI
3I2	AI	TI	AI	3I2	AI	TI	AI
3I3	AI	TI	AI	3I3	AI	TI	AI
I0	AI	TI	AI	I0	AI	TI	AI
U0	AI	TI	AI	U0	AI	TI	AI
I0A	AI	TI	AI	I0A	AI	TI	AI
I0SA	AI	TI	AI	I0SA	AI	TI	AI
I2	AI	TI	AI	I2	AI	TI	AI
U0A	AI	TI	AI	U0A	AI	TI	AI
U0SA	AI	TI	AI	U0SA	AI	TI	AI

ARC CBF P

AI	TI	AI
AI	TI	AI
AI	TI	AI

Blocking and output matrix

- Measurements
- IL1, IL2, IL3
  - I<sub>0</sub>, U<sub>0</sub>
  - UL1, UL2, UL3
  - U<sub>12</sub>, U<sub>23</sub>, U<sub>31</sub>
  - P, Q, S, PF, f

Front panel

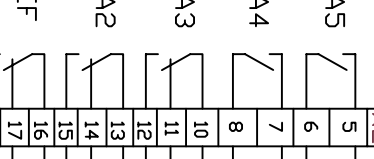
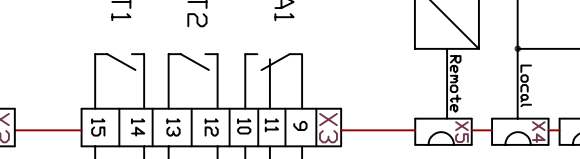

Mode: Phase (U<sub>0</sub> is calculated)

Itemref	Quantity	Title/Name, designation, material, dimension etc		Article No./Reference
Designed by R. Vaahterä	Checked by	Approved by - date	Title/Name	Date 2003.01.01
VAMP Ltd P.O.Box 5 (Runsorttie 7) FIN-65381 VAASA	Phone +358-6-212 1100 Fax +358-6-212 1105 email vampp@vamp.fi		Filename VAMP 230 - 3 C 7 C A A	Scale
FINLAND			Drawing number VD230.EN.002	Sheet 2/4
			Edition A	

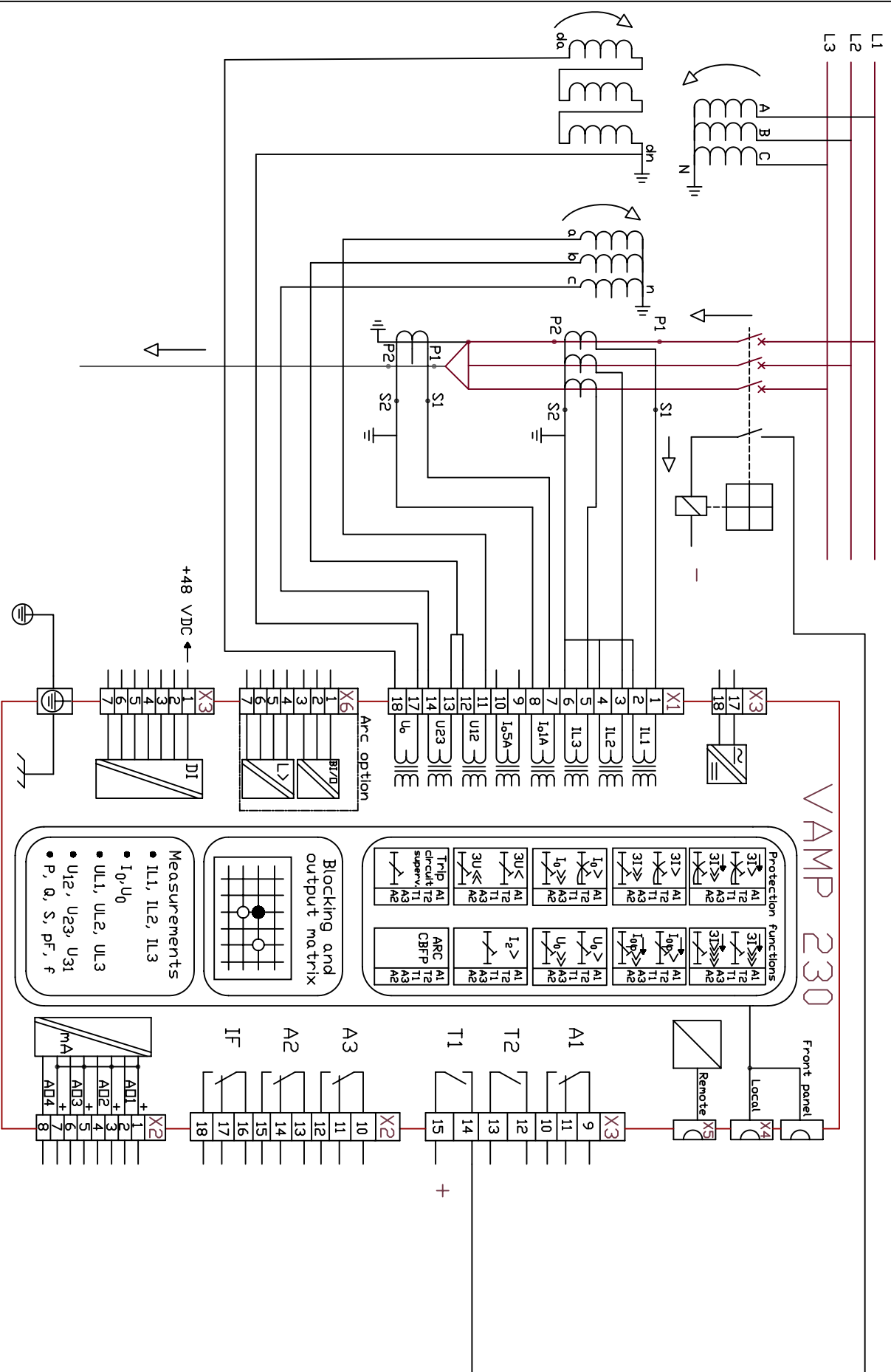

Mode: Line + U<sub>0</sub>

Itemref	Quantity	Title/Name, designation, material, dimension etc	Article No./Reference
Designed by R.Vaahtera	Checked by	Approved by - date	Date 2003-01-01
VAMP Ltd P.O.Box 5 (Runsorintie 7 ) FIN-65381 VAASA FINLAND	Phone +358-6-212 1100 Fax +358-6-212 1105 email vamp@vamp.fi	Filename VAMP 230 - 3 C 7 C A B	Scale
		Drawing number VD230.EN.003	Edition A
			Sheet 3/4

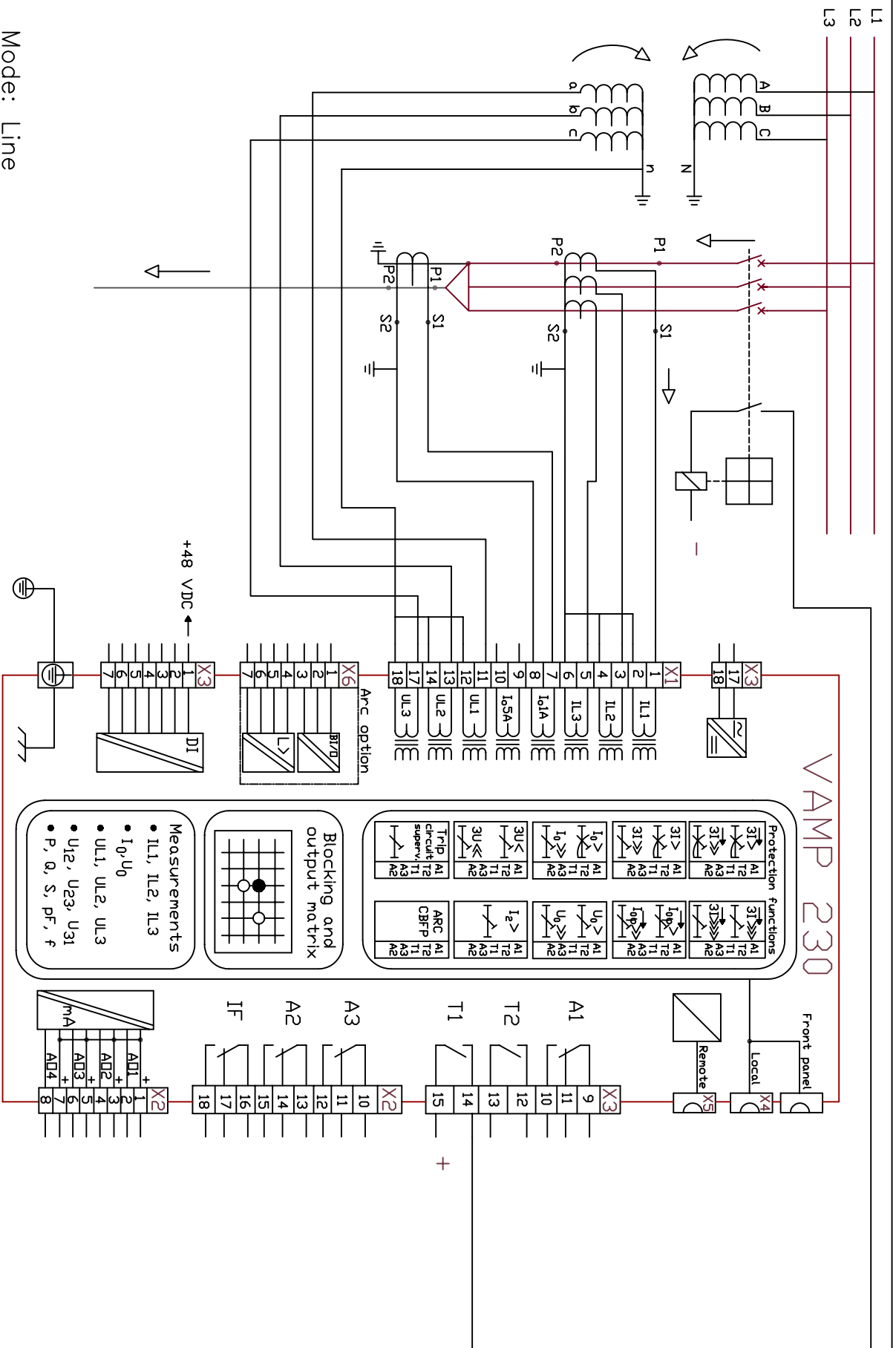

Mode: Line  
 Residual voltage is calculated using symmetrical components.

Itemref	Quantity	Title/Name, designation, material, dimension etc	Article No./Reference
Designed by R. Vaahterä	Checked by	Approved by - date	Date 2003-01-01
VAMP Ltd P.O.Box 5 (Runsorinte 7) FIN-65381 VAASA	Phone +358-6-212 1100 Fax +358-6-212 1105 email vampp@vamp.fi	Filename VAMP 230 - 3 C 7 C A B	Scale
FINLAND		Drawing number VD230.EN.004	Sheet 4/4



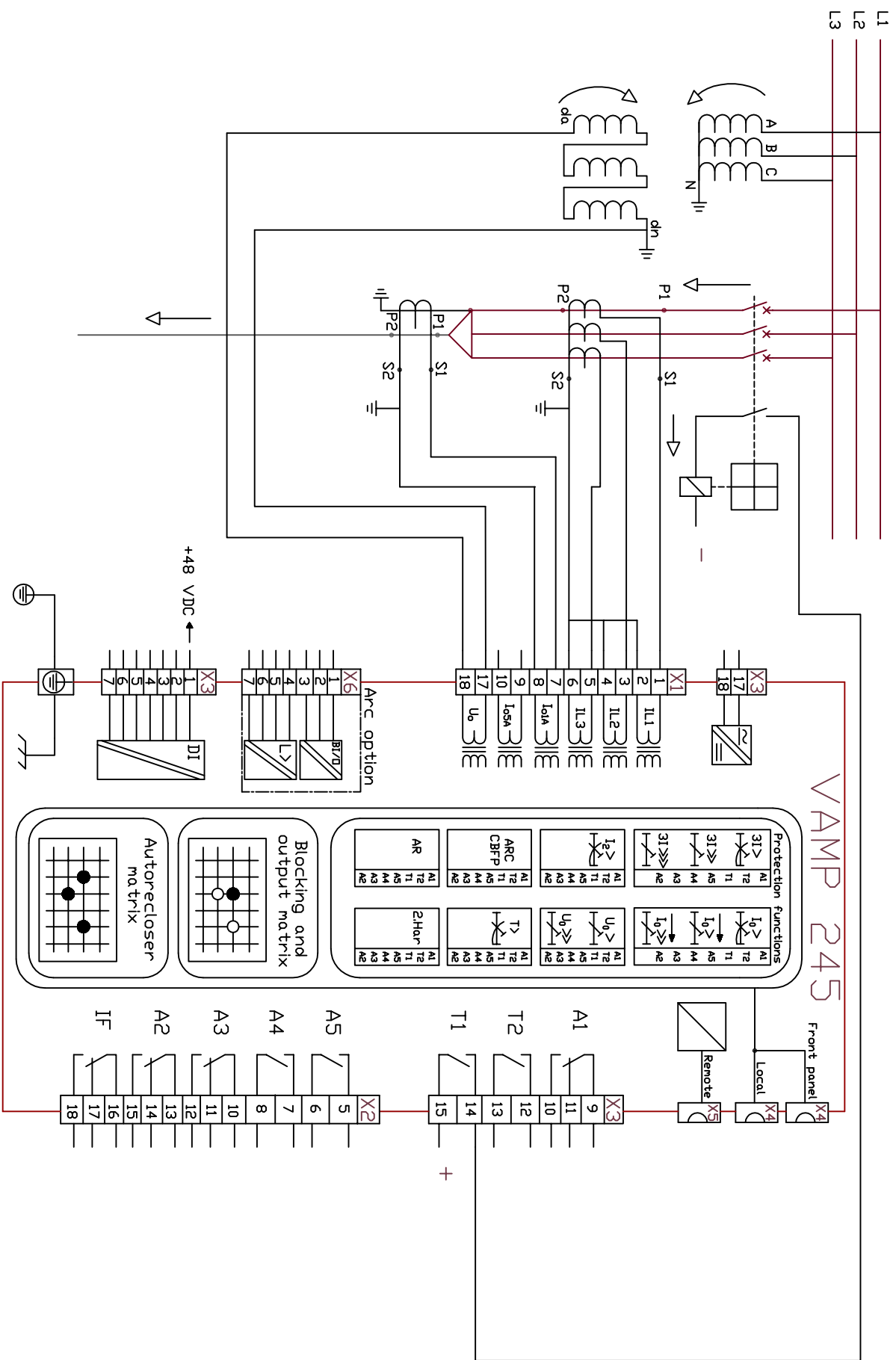

# VAMP 245

Itemref	Quantity	Title/Name, designation, material, dimension etc	Article No./Reference
Designed by C/R	Checked by	Approved by - date	Date 2009.12.04
Vamp Ltd P.O.Box 810 (Yrittäjänkatu 15) FIN-65381 VAASA FINLAND		Phone +358 20 753 3200 Fax +358 20 753 3205 email vamp@vamp.fi	File name VAMP 245 - 3 C 7 C A A Drawing number VD245.EN002-1 Edition B Sheet 1/2

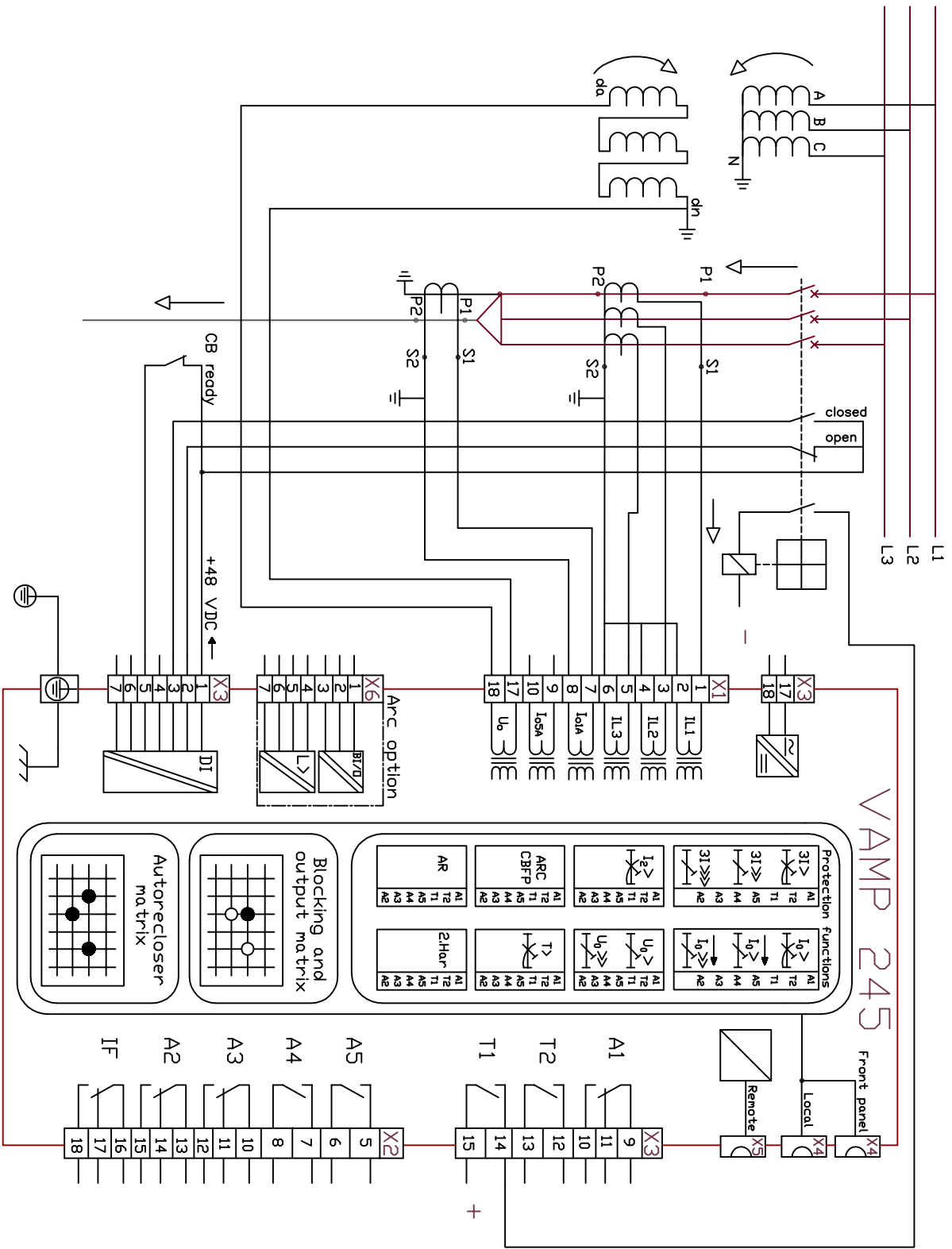

# VAMP 245

**Protection functions**

3I1	AI	T2	AI	T2	TI	AI	T2	TI	AI	T2	TI	AI	T2	TI	AI	T2	TI
3I2	AI	T2	AI	T2	TI	AI	T2	TI	AI	T2	TI	AI	T2	TI	AI	T2	TI
3I3	AI	T2	AI	T2	TI	AI	T2	TI	AI	T2	TI	AI	T2	TI	AI	T2	TI
I0	AI	T2	AI	T2	TI	AI	T2	TI	AI	T2	TI	AI	T2	TI	AI	T2	TI
U0	AI	T2	AI	T2	TI	AI	T2	TI	AI	T2	TI	AI	T2	TI	AI	T2	TI
T	AI	T2	AI	T2	TI	AI	T2	TI	AI	T2	TI	AI	T2	TI	AI	T2	TI
AR	AI	T2	AI	T2	TI	AI	T2	TI	AI	T2	TI	AI	T2	TI	AI	T2	TI
2Har	AI	T2	AI	T2	TI	AI	T2	TI	AI	T2	TI	AI	T2	TI	AI	T2	TI

**Blocking and output matrix**

A1	<input type="checkbox"/>
A2	<input type="checkbox"/>
A3	<input type="checkbox"/>
A4	<input type="checkbox"/>
A5	<input type="checkbox"/>
IF	<input type="checkbox"/>

**Autorecloser matrix**

<input type="checkbox"/>	<input type="checkbox"/>	<input type="checkbox"/>
<input type="checkbox"/>	<input type="checkbox"/>	<input type="checkbox"/>
<input type="checkbox"/>	<input type="checkbox"/>	<input type="checkbox"/>

Itemref	Quantity	Title/Name, designation, material, dimension etc	Article No./Reference
Designed by C/R	Checked by	Approved by - date	Title/Name Date 2009.12.04
<b>VAMP Ltd.</b> P.O.Box 810 (Yrittäjänkatu 15) Phone +358 20 753 3200 FIN-65381 VAASA Fax +358 20 753 3205 FINLAND email vamp@vamp.fi		Filename <b>VAMP 245 - 3 C 7 C A A _2</b>	Drawing number <b>VD245.EN002-2</b>
		Edition B	Sheet 2/2



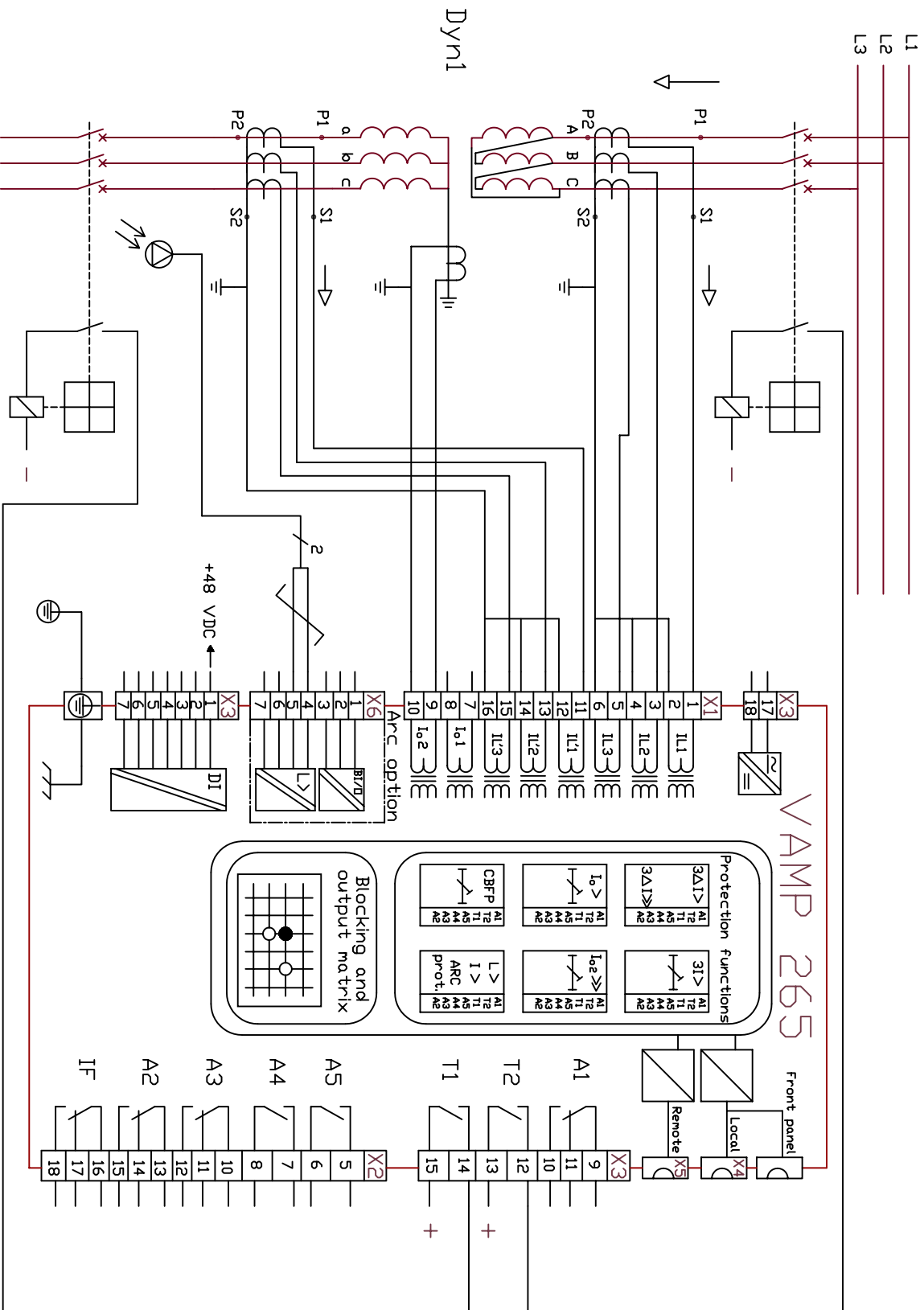

Itemref	Quantity	Title/Name, designation, material, dimension etc		Article No./Reference
Designed by R. Vaahtera	Checked by	Approved by - date	Title/Name Dyn1	Date 2001
VAMP Ltd. P.O.Box 5 (Runsorinte 7) FIN-65381 VAASA		Phone +358-6-212 1100 Fax +358-6-212 1105 email vampp@vamp.fi	Filename VAMP 265 - 5 A 7 C A A	Edition A
			Drawing number VD265.EN.001	Sheet 1/7

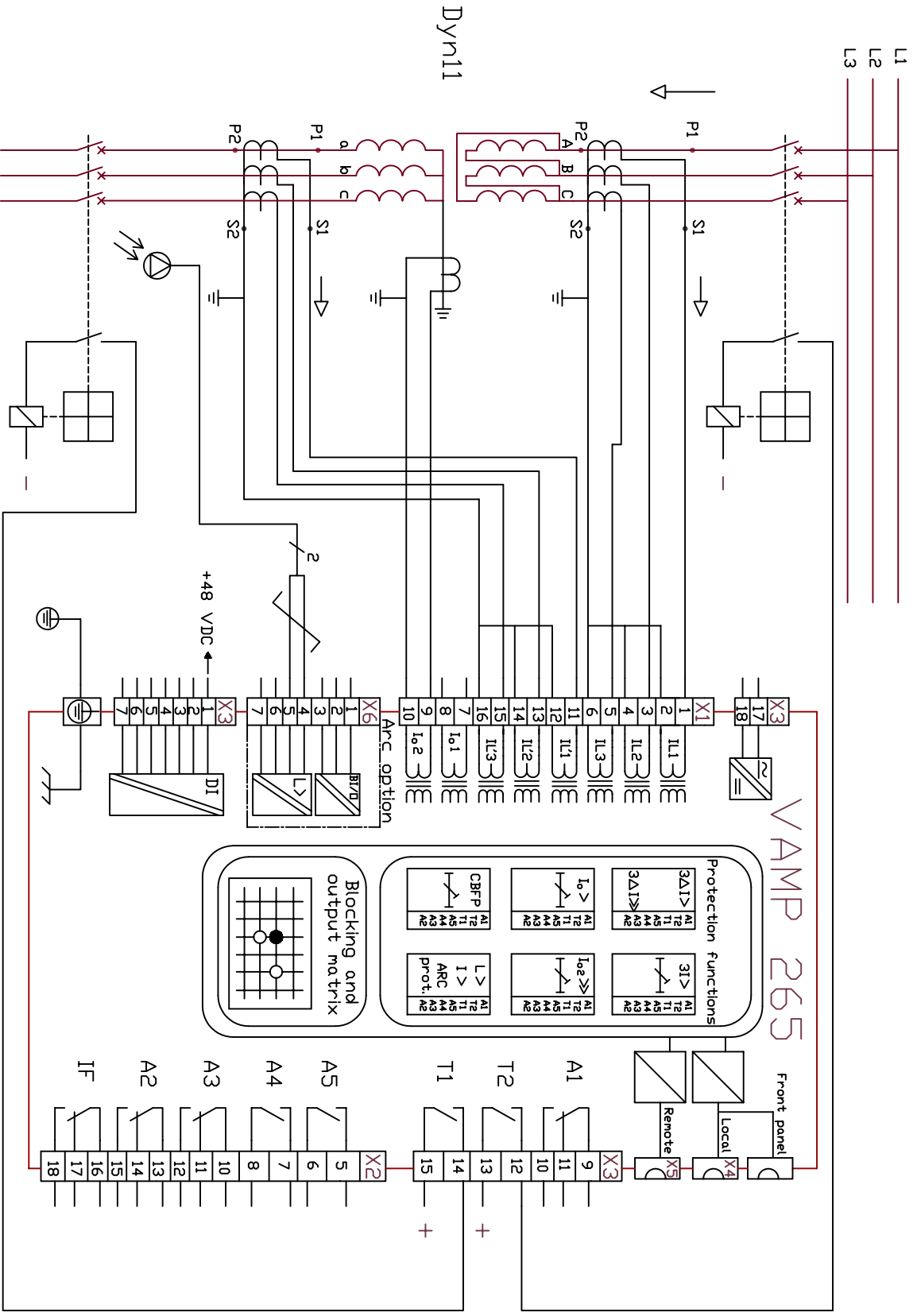

Itemref	Quantity	Title/Name, designation, material, dimension etc		Article No./Reference
Designed by R. Vaahtera	Checked by	Approved by - date	Title/Name Dyn11	Date 2003.01.01
VAMP Ltd P.O.Box 5 (Runsorinte 7) FIN-65381 VAASA		Phone +358-6-212 1100 Fax +358-6-212 1105 email velco@velco.fi	Filename VAMP 265 - 5 A 7 C A A	Edition A
FINLAND			Drawing number VD265.EN.002	Sheet 2/7

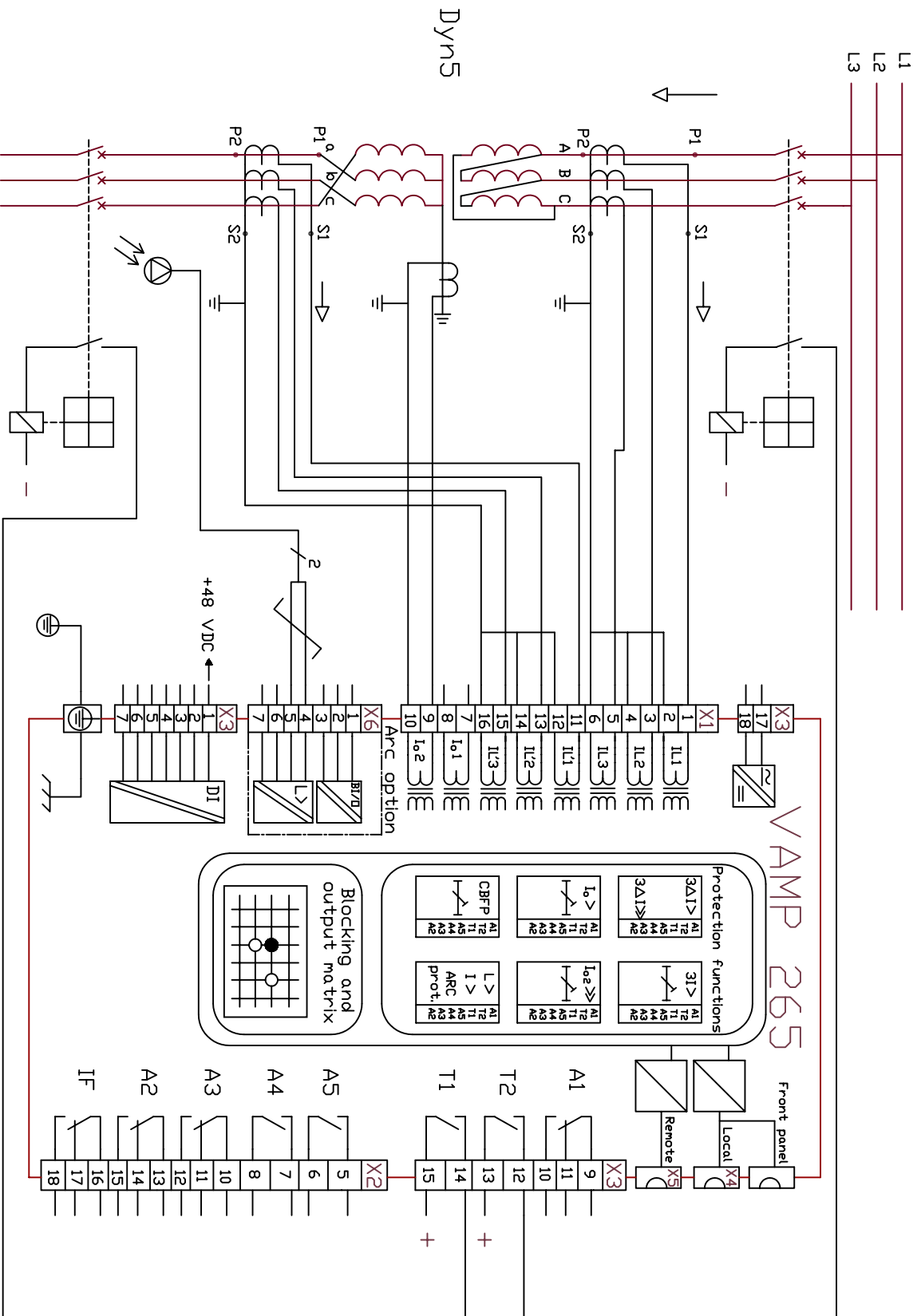

Itemref	Quantity	Title/Name, designation, material, dimension etc		Article No./Reference
Designed by R. Vaahtera	Checked by	Approved by - date	Title/Name Dyn5	Date 2003.01.01
VAMP Ltd P.O.Box 5 (Runsorinte 7) FIN-65381 VAASA		Phone +358-6-212 1100 Fax +358-6-212 1105 email vampp@vamp.fi		Filename VAMP 265 - 5 A 7 C A A Drawing number VD265.EN.003
FINLAND				Edition A
				Sheet 3/7

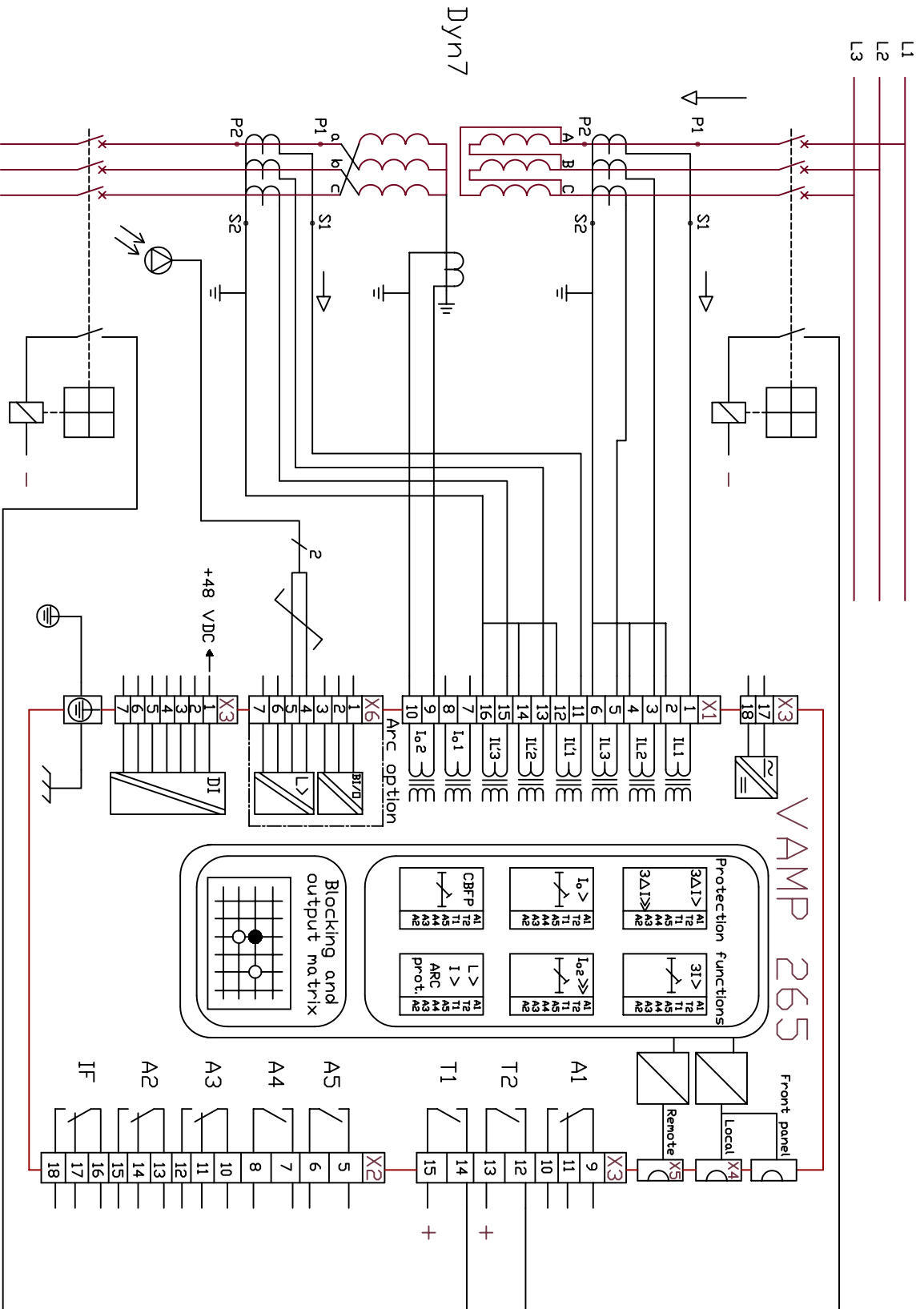

Itemref	Quantity	Title/Name, designation, material, dimension etc		Article No./Reference
Designed by R. Vaahtera	Checked by	Approved by - date	Title/Name Dyn7	Date 2003.01.01
VAMP Ltd P.O.Box 5 ( Runsorinte 7 ) FIN-65381 VAASA		Phone +358-6-212 1100 Fax +358-6-212 1105 email vampp@vamp.fi	Filename VAMP 265 - 5 A 7 C A A	Edition A
			Drawing number VD265.EN.004	Sheet 4/7

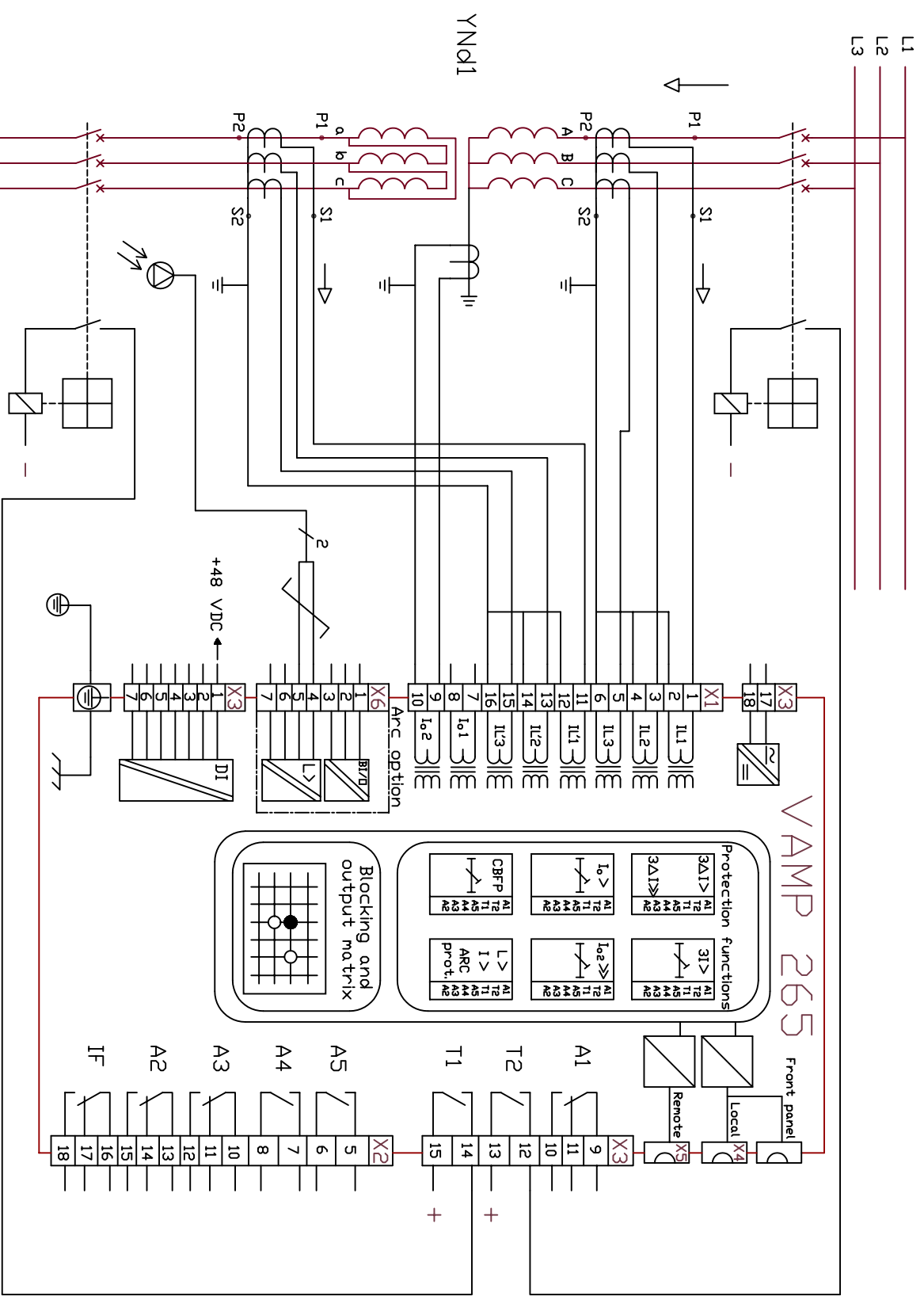

Itemref	Quantity	Title/Name, designation, material, dimension etc		Article No./Reference
Designed by R. Vaahtera	Checked by	Approved by - date	Title/Name YNd1	Date 2003.01.01
VAMP Ltd P.O.Box 5 (Runsorinte 7) FIN-65381 VAASA		Phone +358-6-212 1100 Fax +358-6-212 1105 email vampp@vamp.fi	Filename VAMP 265 - 5 A 7 C A A	Edition A
			Drawing number VD265.EN.005	Sheet 5/7