

Ultrasonic Sensor M30

Plastic ...: XXS30P1●M12

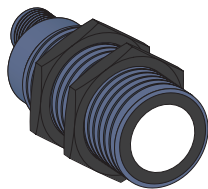

⚠ WARNING

UNINTENDED EQUIPMENT OPERATION

Do not use this product to detect objects within the deadband (blind zone) or outside the sensing window.
Failure to follow these instructions can result in death, serious injury, or equipment damage.

<http://qr.tesensors.com/XX0003>

Dimensions

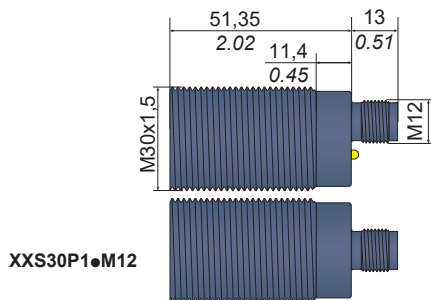

LEDs

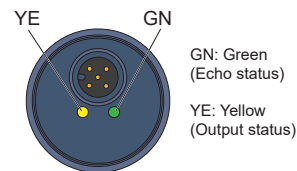

Connectors wiring

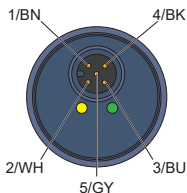

Pin Number	Wire Color	Description
①	BN: Brown	+12...24 Vdc
②	WH: White	Input teach
③	BU: Blue	0 Vdc
④	BK: Black	Output
⑤	GY: Grey	Synchronization

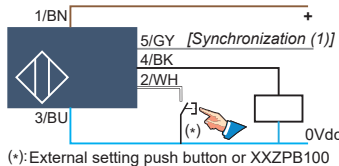

(+): External setting push button or XXZPB100

Note:
(1): See synchronization section

Tightening torque

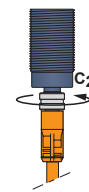
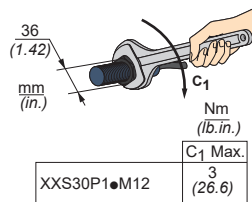

$C_2 \leq 2 \text{ Nm} / (17.7 \text{ lb.in.})$

Wiring diagrams

Analog Output

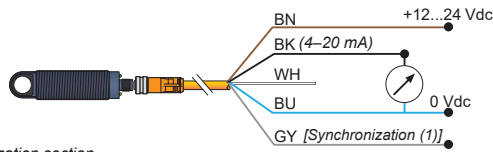
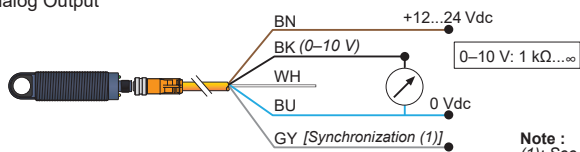

Note:
(1): See synchronization section

4-20 mA:
- For 12 Vdc, Load $\leq 250 \Omega$
- For 24 Vdc, Load $\leq 850 \Omega$

Sensor type	4-20 mA	0-10 V
Rated supply voltage	12...24 Vdc Min = 10 Vdc Max = 30 Vdc	24 Vdc Min = 14 Vdc Max = 30 Vdc
	with reverse polarity protection	

Synchronization (side by side application)

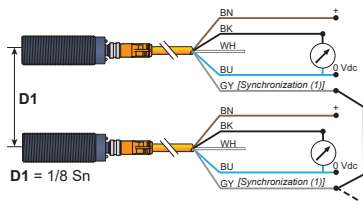

Synchronization operation

Up to 8 sensors can be synchronized to operate side by side by electrically connecting all pin no.5 (grey) wires together. To synchronize more than 8 sensors a PLC output can be used (the pins no.5 must be simultaneously driven by the rising edge of a pulse).
NOTE (1): The pulse must be at a high level of 12 to 24 Vdc and a low level of 0 to 2Vdc. All sensors should be the same model and have the same cycle time setting. The high pulse width should be 1 ms, and the low should be at least as long as the sensor cycle time setting (default cycle times: 1m sn= 15 ms).
NOTE (2): When the pin no.5 is at low level or at high level, object sensing is suspended and the sensor output holds the last valid output state before suspension.

Multiplexing (face to face application)

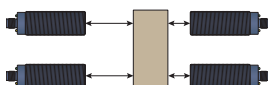

This function can be used to avoid disturbances when operating sensors face to face. A unique address must be assigned to each sensor (or group of sensors) with the use of the XX Configuration Software (prior to wiring the sensors), and all pin no.5 (grey) wires must be connected together.
For sequencing with a PLC, please contact your local Telemecanique Sensors Technical Support Group.

Electrical equipment should be installed, operated, serviced, and maintained only by qualified personnel.
No responsibility is assumed by Schneider Electric for any consequences arising out of the use of this material.
© 2019 Schneider Electric. "All Rights Reserved."

Tilt angle

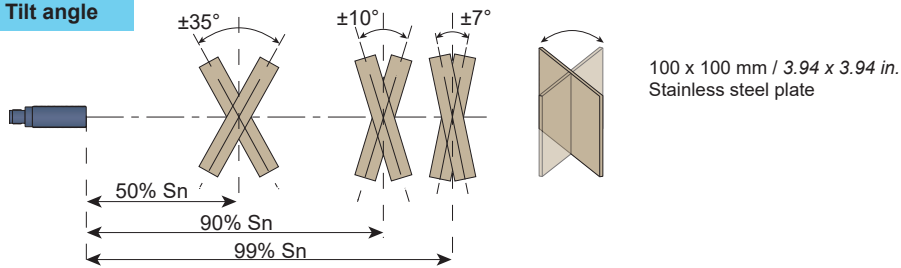

Detection curves for different objects

Detection curve with 100 x 100 mm square target

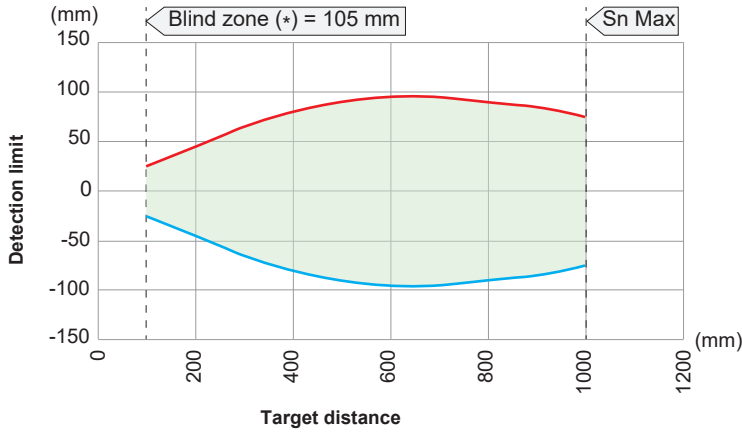

(*) : Blind zone

100 x 100 mm / 3.94 x 3.94 in.
Stainless steel plate



Detection curve with round bar

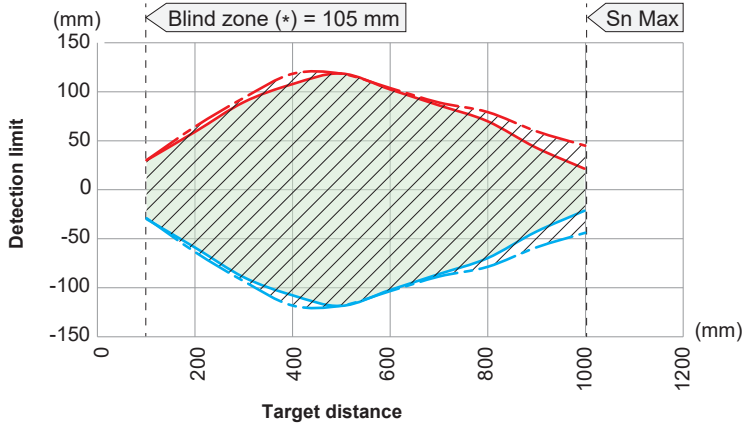

Ø 10 mm / 0.394 in.
Stainless steel cylinder



Ø 25 mm / 0.984 in.
Stainless steel cylinder

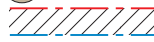

Wiring accessory

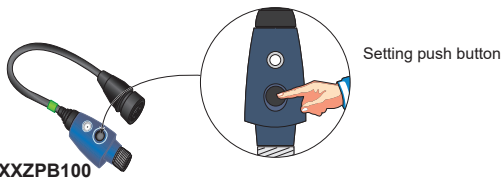

Cables

5-pin, 5-wire
(for synchronization)

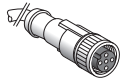

XZCPV11V12L2 (2 m / 6.6 ft)
XZCPV11V12L5 (5 m / 16.4 ft)
XZCPV11V12L10 (10 m / 32.8 ft)

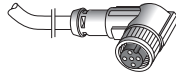

XZCPV12V12L2 (2 m / 6.6 ft)
XZCPV12V12L5 (5 m / 16.4 ft)
XZCPV12V12L10 (10 m / 32.8 ft)

5-pin, 4-wire
(no synchronization)

XZCP1141L2 (2 m / 6.6 ft)
XZCP1141L5 (5 m / 16.4 ft)
XZCP1141L10 (10 m / 32.8 ft)

XZCP1241L2 (2 m / 6.6 ft)
XZCP1241L5 (5 m / 16.4 ft)
XZCP1241L10 (10 m / 32.8 ft)

M12 connectors

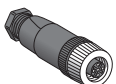

XZCC12FDM50B



XZCC12FCM50B

Mounting accessory

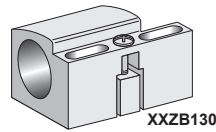

Recommended to use for sensor applications at
operating temperatures -25 ... 0 °C (-13...32 °F)

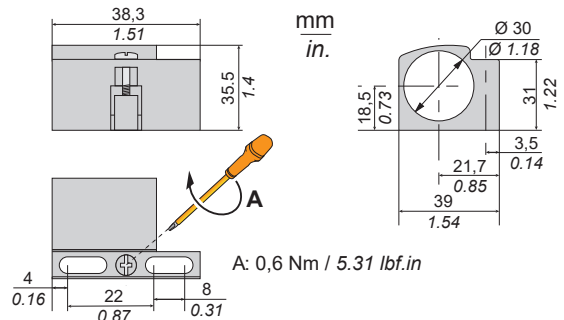

Sensor setting with teach procedure

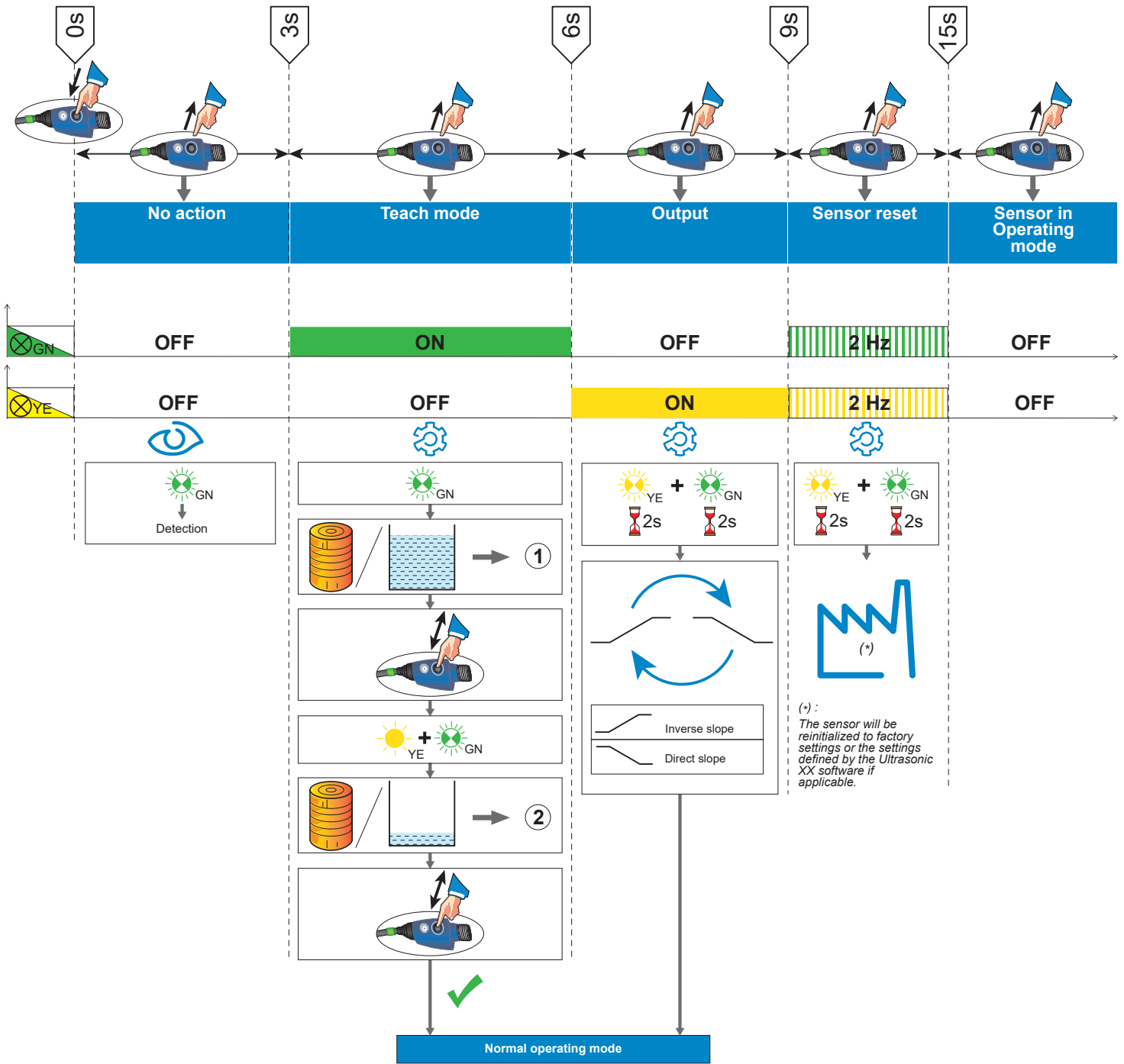

Legend :

- ⊗ OFF
- ON
- ⚡ Flashing
- GN: Green
- YE: Yellow
- ☀️ + 🌱 Processing (2s)
- ☀️ Setting error (2s)
- ① Near limit
- ② Far limit
- 👉 Press the teach button
- 👈 Release the teach button
- 👉👈 Press and release briefly
- ⚙️ Setting
- 📊 Factory setting (*)
- 📦 Object
- 📊 Level

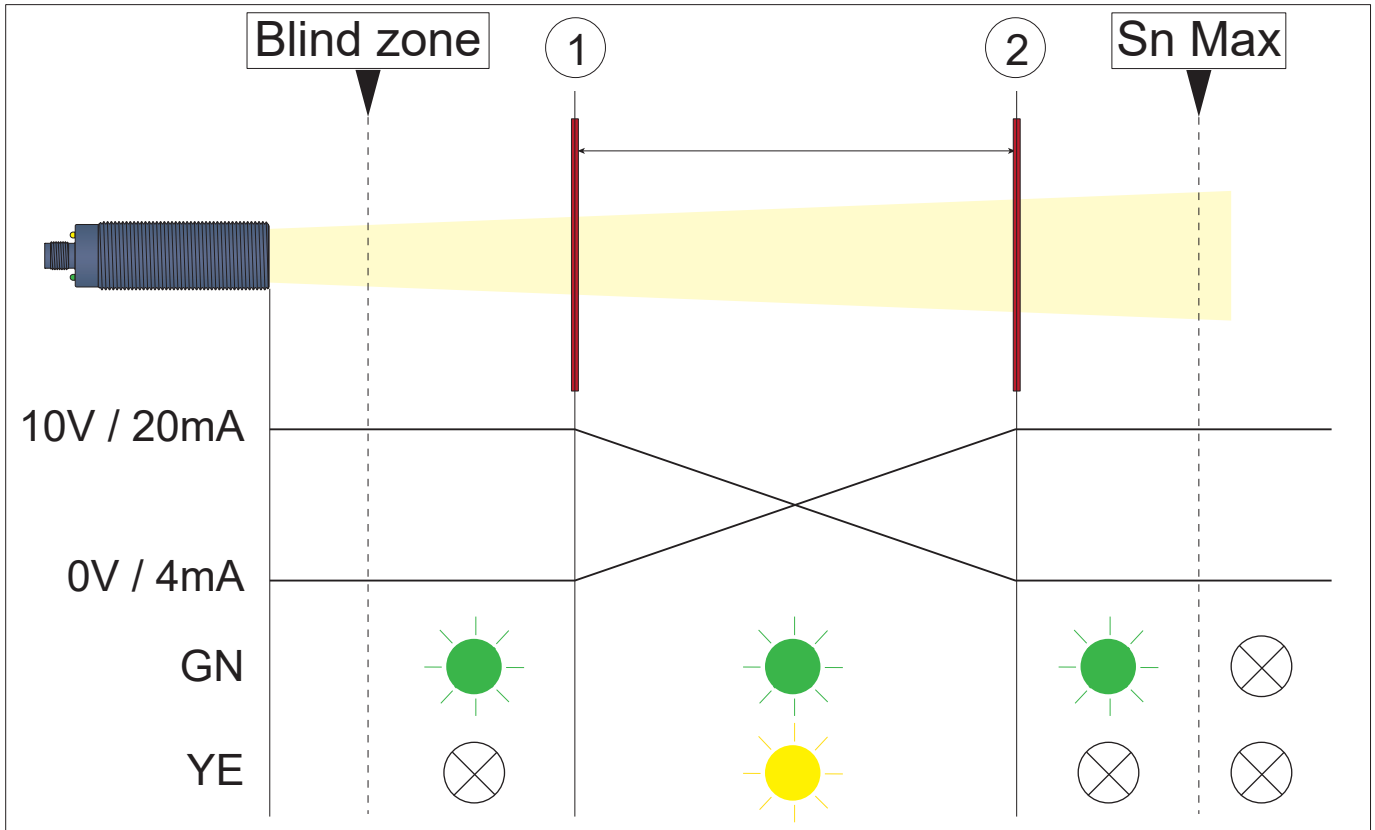

Scan the Qr-code to access this Instruction Sheet in different languages.



Note :

You can download this Instruction Sheet in different languages from our website at: www.tesensors.com
 We welcome your comments about this document. You can reach us by e-mail at: customer-support@tesensors.com

<http://qr.tesensors.com/XX0003>