

ComPacT NSX100-250
TransferPacT FXM100-250

Downstream 3P/4P Busbar Coupling 250
Couplage aval 3P/4P 250
3P/4P acoplamiento abajo 250
下游 3P/4P 母线耦合 250

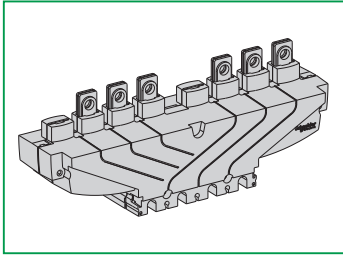

Schneider
Electric

S1A63164-07

PLEASE NOTE

- Electrical equipment should be installed, operated, serviced, and maintained only by qualified personnel.
- No responsibility is assumed by Schneider Electric for any consequences arising out of the use of this material.

REMARQUE IMPORTANTE

- L'installation, l'utilisation, la réparation et la maintenance des équipements électriques doivent être assurées par du personnel qualifié uniquement.
- Schneider Electric décline toute responsabilité quant aux conséquences de l'utilisation de ce matériel.

TENGA EN CUENTA

- La instalación, manejo, puesta en servicio y mantenimiento de equipos eléctricos deberán ser realizados sólo por personal cualificado.
- Schneider Electric no se hace responsable de ninguna de las consecuencias del uso de este material.

请注意

- 电气设备的安装、操作、维修和维护工作仅限于合格人员执行。
- Schneider Electric 不承担由于使用本资料所引起的任何后果。

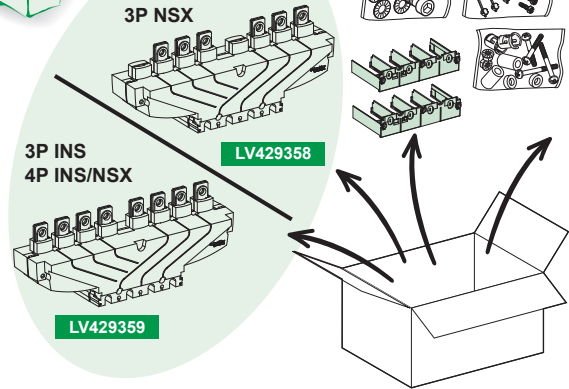

x 2	x 2	x 2	x 2	x 4
x 2	x 2	x 4		
x 4	x 2	x 2	(ST3 x 16) x 2	(ST3 x 12) x 4
(M8 x 20) x 4	x 2	x 2	(M5 x 70) x 2	(M5 x 95) x 2

mm
in

4
 8
 5/32
 5/16

PZ2

⚠️ DANGER / DANGER / PELIGRO / 危险 / GEFAHR / PERICOLO / PERIGO / ОПАСНОСТЬ

HAZARD OF ELECTRIC SHOCK, EXPLOSION OR ARC FLASH

- Apply appropriate personal protective equipment (PPE) and follow safe electrical work practices. See NFPA 70E, CSA Z462 or local equivalent.
- This equipment must only be installed and serviced by qualified electrical personnel.
- Turn off all power supplying this equipment before working on or inside equipment. Lock the switchgear in the isolated position.
- Always use a properly rated voltage sensing device to confirm power is off.
- Install safety barriers and display a danger sign.
- Replace all devices, doors, and covers before turning on power to this equipment. Failure to follow these instructions will result in death or serious injury.

RISQUE D'ÉLECTROCUTION, D'EXPLOSION OU D'ECLAIR D'ARC ÉLECTRIQUE

- Portez un équipement de protection personnelle adapté et respectez les consignes de sécurité électrique courantes. Reportez-vous aux normes NFPA 70E, CSA Z462 ou aux textes équivalents applicables dans votre région du monde.
- Seul un personnel qualifié doit effectuer l'installation et l'entretien de cet appareil.
- Débranchez toutes les sources d'alimentation de cet équipement avant d'effectuer toute opération interne ou externe sur celui-ci. Verrouillez l'appareillage en position isolée.
- Utilisez toujours un dispositif de détection de tension ayant une valeur nominale appropriée pour vous assurer que l'alimentation est coupée
- Installez des barrières de sécurité et affichez un signal de danger.
- Remettez en place tous les équipements, les portes et les capots avant de remettre l'appareil sous tension. Si ces directives ne sont pas respectées, cela entraînera la mort ou des blessures graves.

PELIGRO DE DESCARGA ELÉCTRICA, EXPLOSIÓN O ARCO ELÉCTRICO

- Utilice el equipo de protección personal (PPE) adecuado y siga las recomendaciones para el trabajo seguro con dispositivos eléctricos. Consulte NFPA 70E, CSA Z462 o la norma local equivalente.
- Solo el personal de electricidad cualificado podrá instalar, programar y realizar el mantenimiento del equipo.
- Desconecte toda la alimentación de este equipo antes de trabajar en él o en su interior. Bloquee la apartamentación eléctrica en la posición de aislamiento.
- Utilice siempre un dispositivo de detección de tensión de capacidad adecuada para confirmar la ausencia de alimentación eléctrica.
- Instale barreras de seguridad y coloque un cartel de peligro.
- Vuelva a colocar todos los dispositivos, las puertas y las tapas antes de conectar la alimentación de este equipo. El incumplimiento de estas instrucciones podrá causar la muerte o lesiones serias.

电击、爆炸或弧闪的危险

- 采用适当的个人防护设备 (PPE) 并遵循电气作业安全守则。请参阅 NFPA 70E, CSA Z462 或当地对应的标准。
- 只有具备相应资质的电气人员才能安装和维修该设备。
- 在该设备表面或内部工作之前, 请关闭设备的全部电源。将开关锁定在隔离位置。
- 确保使用合适的额定电压传感器确认电源已关闭。
- 安装安全栅并显示危险标志。
- 更换所有设备、门和盖, 然后再打开该设备的电源。不遵循上述说明将导致人员伤亡。

GEFAHR VON ELEKTRISCHEM SCHLAG, EXPLOSION ODER LICHTBOGEN

- Tragen Sie persönliche Schutzausrüstung (PSA) und befolgen Sie sichere Verfahren im Umgang mit Elektrogeräten. Siehe NFPA 70E, CSA Z462 oder lokale Entsprechung.
- Diese Geräte dürfen nur von qualifizierten Elektrikern installiert und gewartet werden.
- Schalten Sie vor Arbeiten am bzw. im Innern des Geräts die gesamte Spannungsversorgung ab. Die Schaltanlage in die Trennstellung bringen.
- Verwenden Sie für die Prüfung vorhandener Spannung stets einen Spannungsfühler mit zutreffender Bemessungsspannung.
- Bringen Sie Sicherheitsbarrieren und einen Warnhinweis an.
- Bringen Sie alle Vorrichtungen, Türen und Abdeckungen wieder an, bevor Sie das Gerät einschalten. Die Nichtbeachtung dieser Anweisungen führt zu Tod oder schweren Verletzungen.

RISCHIO DI FOLGORAZIONE, ESPLOSIONI O ARCO ELETTRICO

- Utilizzare dispositivi di protezione individuale (DPI) idonei e adottare misure di sicurezza adeguate per lavori elettrici. Vedere le normative NFPA 70E, CSA Z462 o le norme equivalenti nel paese di installazione.
- Installazione e manutenzione di questa apparecchiatura si devono affidare solo ad elettricisti qualificati.
- Prima di lavorare con l'apparecchiatura o al suo interno isolare completamente l'alimentazione elettrica. Bloccare l'interruttore in posizione isolata.
- Per verificare che l'alimentazione sia isolata usare sempre un rilevatore di tensione correttamente tarato.
- Installare barriere di sicurezza e apporre un segnale di pericolo.
- Sostituire dispositivi, sportelli e coperture prima di riaccendere l'alimentazione dell'apparecchiatura. Il mancato rispetto di queste istruzioni provocherà morte o gravi infortuni.

RISCO DE ELECTROCUSSÃO, DE EXPLOSIÃO, OU DE ARCO ELÉCTRICO

- Utilize equipamento de protecção pessoal (PPE) e siga os métodos de segurança eléctrica. Consulte NFPA 70E, CSA Z462 ou o equivalente local.
- A instalação e manutenção deste equipamento só devem ser efectuadas por electricistas qualificados.
- Desligue todas as fontes de alimentação do equipamento ou no seu interior. Bloqueie a placa de distribuição na posição isolada.
- Utilize sempre um dispositivo de detecção da tensão nominal adequada para confirmar se a alimentação está desligada.
- Instale barreiras de segurança e apresente um sinal de perigo.
- Substitua todos os dispositivos, portas e tampas antes de ligar a alimentação deste equipamento. A não observância destas instruções resultará em morte, ou ferimentos graves.

ОПАСНОСТЬ ПОРАЖЕНИЯ ЭЛЕКТРИЧЕСКИМ ТОКОМ, ВЗРЫВА ИЛИ ВСПЫШКИДУГИ

- Используйте подходящие средства индивидуальной защиты (СИЗ) и соблюдайте технику безопасности при электротехнических работах. См. NFPA 70E, CSA Z462 или местный эквивалентный стандарт.
- Данное оборудование могут устанавливать и обслуживать только квалифицированные электрики.
- Отключите питание до начала работы снаружи или внутри оборудования.
- Переведите переключатель в изолированное положение.
- Всегда пользуйтесь надлежащим датчиком номинального напряжения для определения отсутствия питания.
- Установите защитные ограждения и знак опасности.
- Установите обратно все устройства, двери и крышки перед включением питания данного оборудования. Несоблюдение этих инструкций приведет к смерти или серьезной травме.

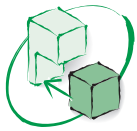

NSX

Rear plate mounting
Fixation sur tôle de fond
Montaje de placa trasera
后板安装

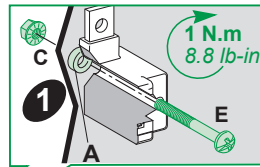
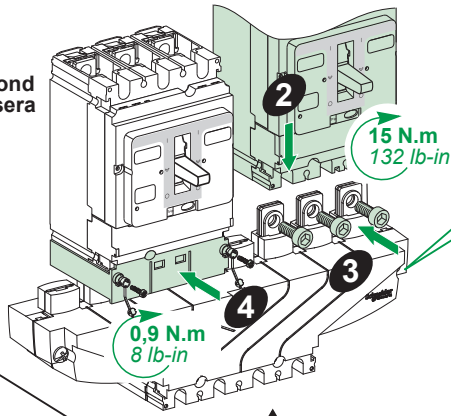
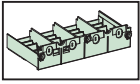

INS

Rear plate mounting
Fixation sur tôle de fond
Montaje de placa trasera
后板安装

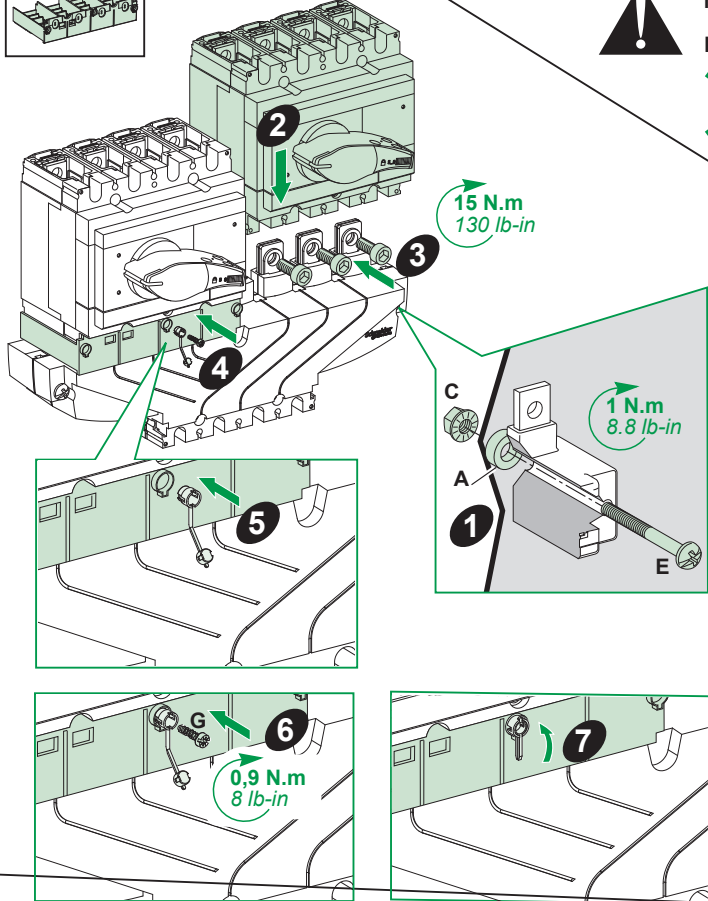
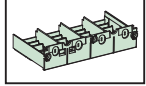

⚠ NSX 250 ⓐ A
NSX 100/160 ✗ A

Mounting on source changeover plate
Fixation sur platine inverseur de source
Montaje en la placa del inversor de fuente
安装在电源切换板上

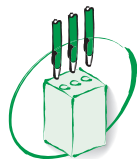
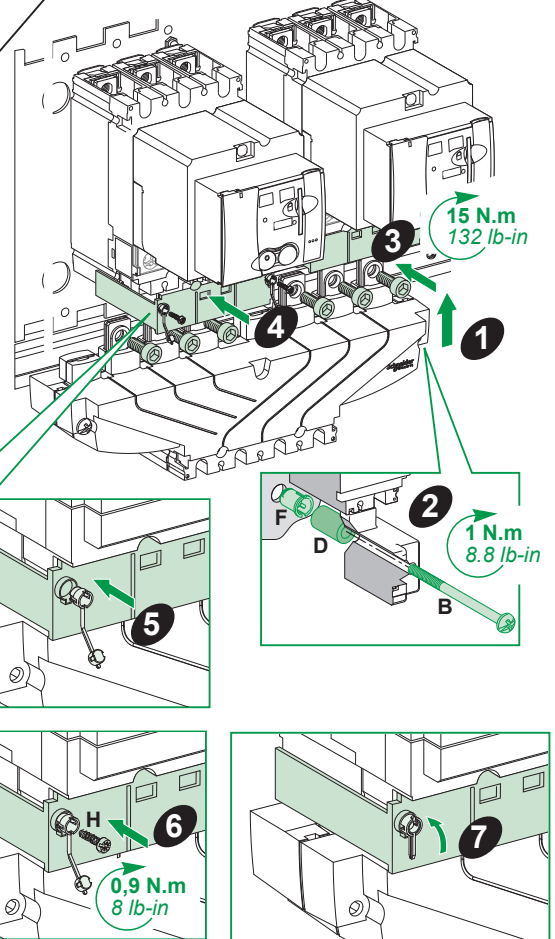

100/160 A

1,5...95 mm ² AWG 16...4/0
x3 LV429242
x4 LV429243

25,4
1

Acier Steel ≤ 160 A > 160 A

S : 1,5...95 mm² Cu / Al
S : AWG 16...4/0 Cu / Al

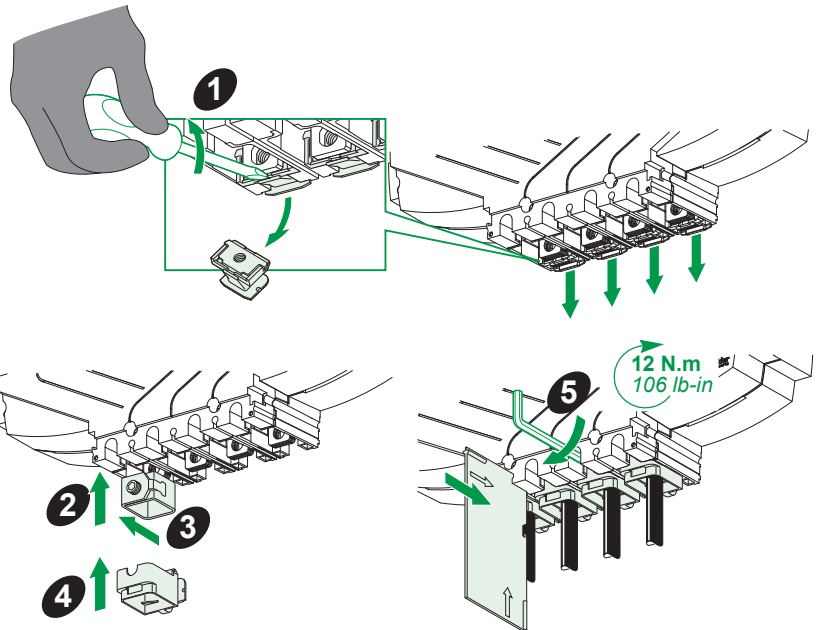

1,5...4 mm²
AWG 16...12

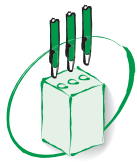

mm
in

100-250 A

100-250 A	
25...95 mm ² AWG 4...4/0	120...150 mm ² 250...300 kcmil
x3 LV429227	LV429259
x4 LV429228	LV429260

Aluminium
Aluminium
Aluminio
铝

- S: 25...50 mm² Cu / Al
AWG 4...1/0 Cu / Al **20 N.m**
180 lb-in
- S: 70...95 mm² Cu / Al
AWG 2/0...4/0 Cu / Al **26 N.m**
225 lb-in
- S: 120...150 mm² Cu / Al
250...300 kcmil Cu / Al **26 N.m**
225 lb-in

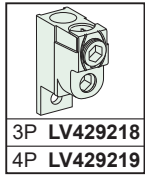
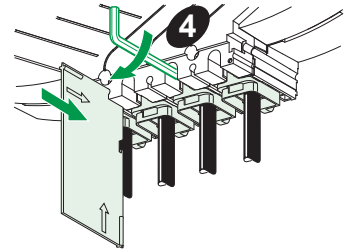
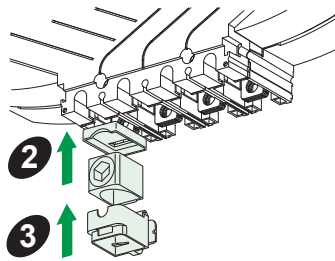
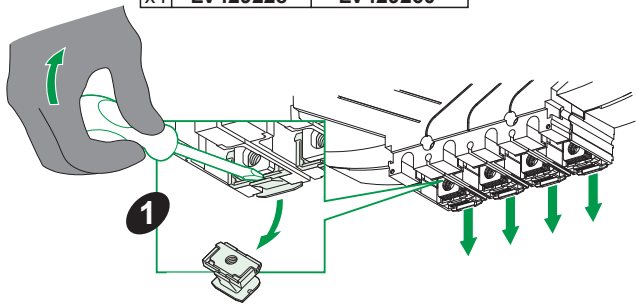

mm
in

50,8
2

25,4
1

22 N.m
191 lb-in

○ S: 50...120 mm² Cu / Al
AWG 1/0...250 kcmil Cu / Al

100 A **10 N.m**
88 lb-in

160-250 A **15 N.m**
130 lb-in

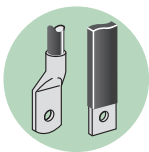
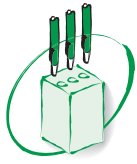
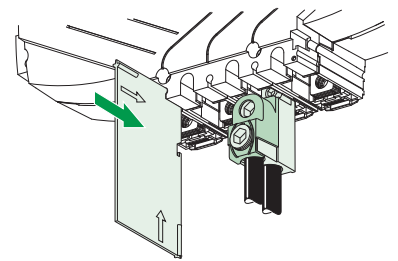

≤ 6
 ≤ 0.23

400
15.74

$10 \leq x \leq 15$
 $0.39 \leq x \leq 0.59$

≤ 10
 ≤ 0.39

≤ 25
 ≤ 0.98

≤ 25
 ≤ 0.98

$\emptyset \geq 8$
 ≥ 0.31

M8 X 20 **15 N.m**
130 lb-in

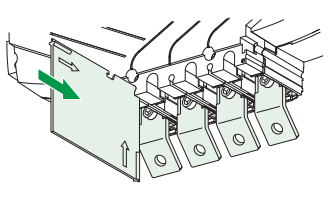
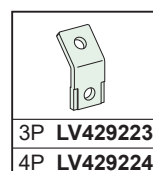
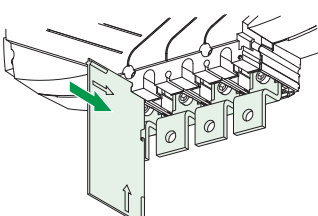
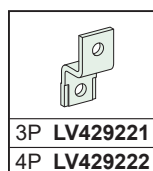
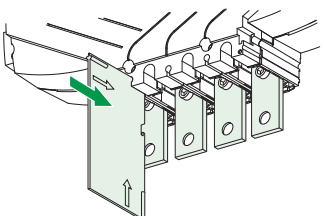
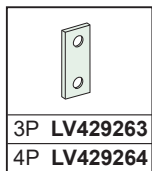
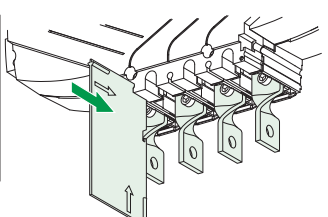
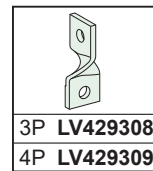
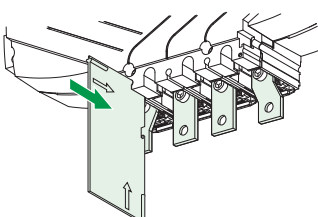
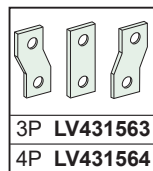
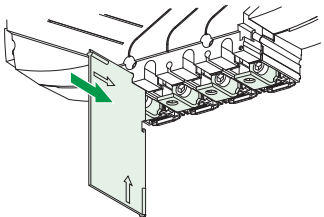
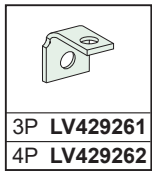
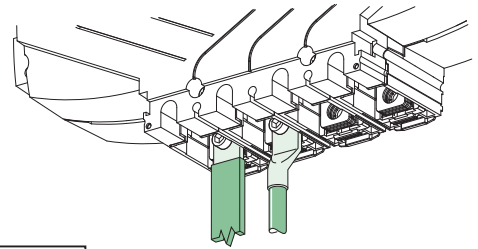

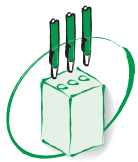

mm
in

3P LV429248
4P LV429249

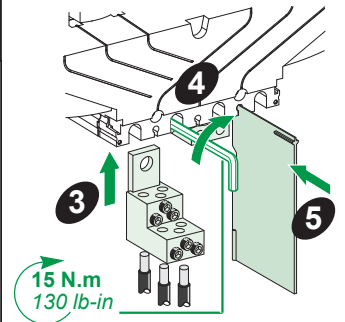
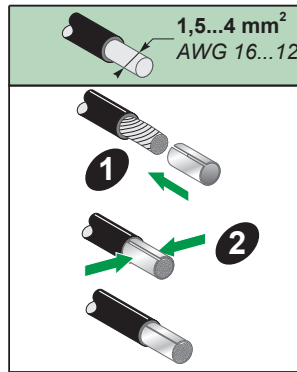
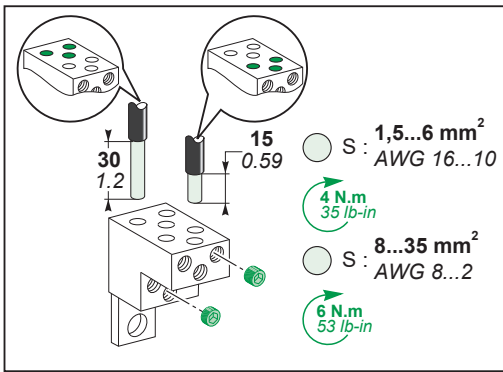

Mandatory U ≥ 500 V
Obligatoire U ≥ 500 V
Obligatorio U ≥ 500 V
必需 U ≥ 500 V

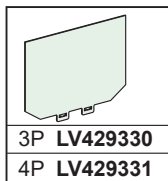
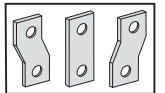

3P LV429330
4P LV429331

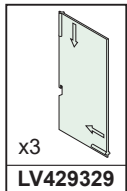
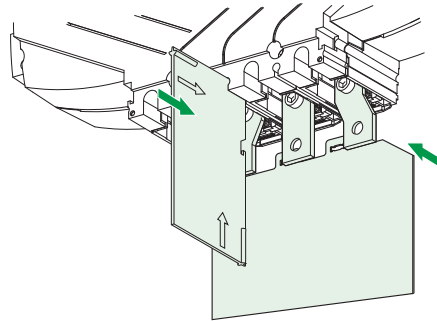

x3

LV429329

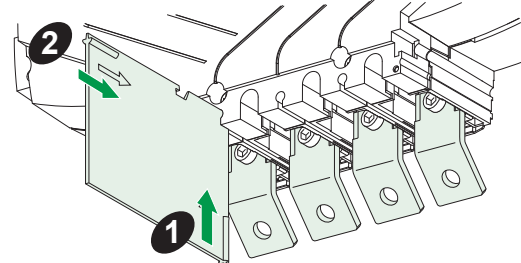
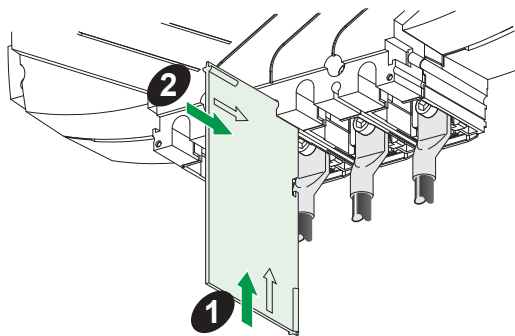

4P LV429518



Mandatory U ≥ 500 V
Obligatoire U ≥ 500 V
Obligatorio U ≥ 500 V
必需 U ≥ 500 V

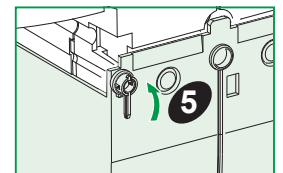
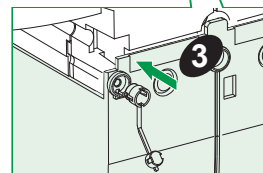
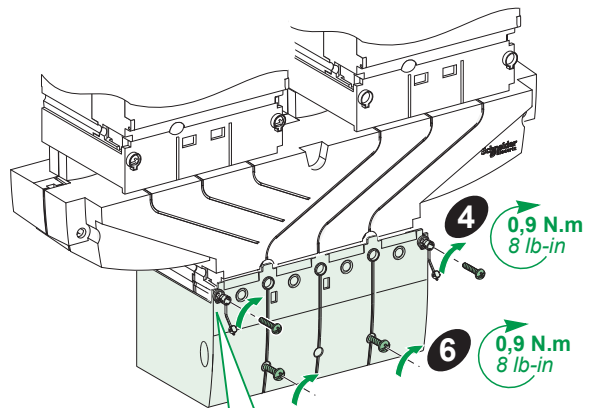
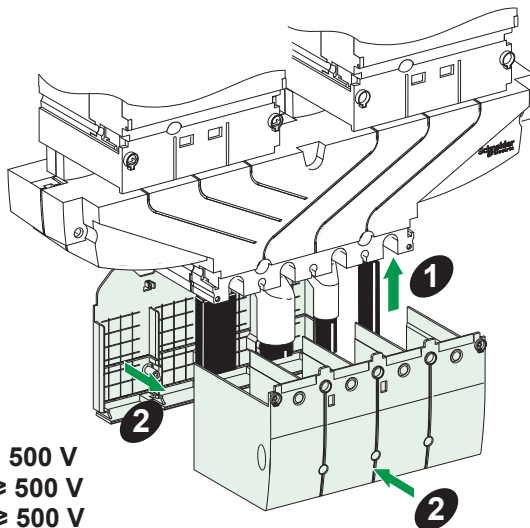

Schneider Electric Industries SAS
35, rue Joseph Monier
CS 30323
F - 92506 Rueil Malmaison Cedex
www.se.com



Printed on
recycled paper.

Schneider Electric Limited
Stafford Park 5
Telford, TF3 3BL
United Kingdom
www.se.com/uk



Уполномоченный поставщик в Республике
Казахстан: ТОО «Шнейдер Электрик»
Адрес: 050010, РК, г. Алматы, пр. Достык, 38,
Бизнес Центр «Кен Дала», 5 этаж, левое крыло.
Тел.: +7 (727) 339 23 57



Қазақстан Республикасында ресми жеткізуші:
ЖШС «Шнейдер Электрик»
Мекен-жайы: Қазақстан Республикасы, Алматы қ.,
Достық даң. ү. 38, «Кен Дала» Бизнес Орталығы, 5-ші қабат.
Тел.: +7 (727) 339 23 57