

**⚠ DANGER / DANGER / GEFAHR / PELIGRO / PERICOLO / PERIGO**

**HAZARDOUS VOLTAGE**

Disconnect all power before servicing equipment.

**Failure to follow these instructions will result in death or serious injury.**

**TENSIÓN PELIGROSA**

Desconecte toda alimentación antes de realizar el servicio.

**Si no se siguen estas instrucciones provocará lesiones graves o incluso la muerte.**

**TENSION DANGEREUSE**

Coupez l'alimentation avant de travailler sur cet appareil.

**Le non-respect de ces instructions provoquera la mort ou des blessures graves.**

**TENSION PERICOLOSA**

Scollegare l'apparecchio dalla presa di corrente prima di qualsiasi intervento.

**Il mancato rispetto di queste istruzioni provocherà morte o gravi infortuni.**

**GEFÄHRliche SPANNUNG**





Vor dem Arbeiten an dem Gerät dessen Stromversorgung abschalten.



**Die Nichtbeachtung dieser Anweisungen führt zu Tod oder schwerer Körperverletzung.**

**TENSÃO PERIGOSA**

Desligue a alimentação antes de trabalhar neste aparelho.

**A não observância destas instruções resultará em morte, ou ferimentos graves.**

						
H●●S21	mm <sup>2</sup>	0.14...1.5	0.14...0.75	0.14...2.5	0.14...4	0.14...1.5
	AWG	26...16	26...18	26...14	26...12	26...16
H●●S21E	mm <sup>2</sup>	0.14...1.5		0.14...1.5	0.14...1.5	
	AWG	26...16		26...16	26...16	

			Nm	0.6
Ø 3,5			pound-inch	5.4



$$I_1 + I_2 + I_n \leq 12A$$

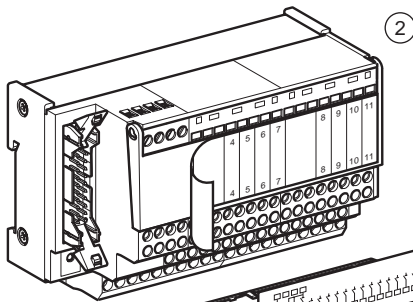
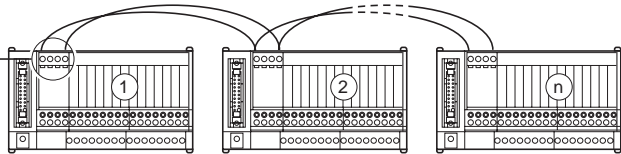
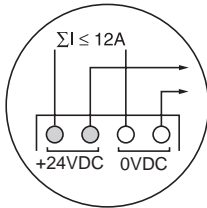

ABE-7LOGV10

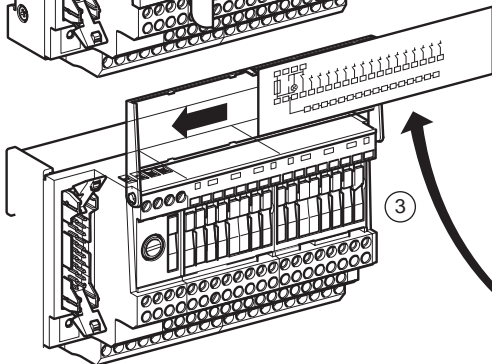

I/Q 0 → 7



I/Q 0 → 11



I/Q 0 → 15

I/Q 16 → 31

I/Q 32 → 47

I/Q 48 → 63

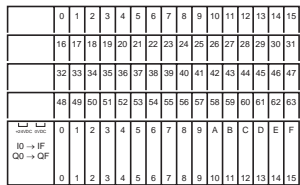

I/Q 0 → F

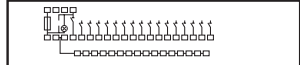

**ATTENTION !****LES FUSIBLES INTERNES PEUVENT NE PAS DESACTIVER LES SORTIES**

Lorsque plusieurs modules ABE7 sont connectés sur une seule source de sortie d'API, les sorties du module peuvent rester actives après dépose ou fusion d'un fusible interne.

Pour désactiver les sorties du module ou pour entreprendre une opération de maintenance sur l'appareillage, arrêter l'API, déconnecter toutes les alimentations et déconnecter le connecteur HE10. L'inobservation de ces instructions peut causer la mort, des blessures graves ou des dommages conséquents sur l'appareillage.

**WARNING !****INTERNAL FUSE MAY NOT DEACTIVATE OUTPUTS**

When multiple ABE7 modules are connected to a single PLC output source, module outputs may remain active after an internal fuse is removed or blown. To deactivate module outputs or to service the equipment, halt the PLC, disconnect all power and disconnect the HE10.

Failure to follow these instructions can result in death, serious injury or equipment damage.

**ACHTUNG!****ES KANN VORKOMMEN, DASS DIE AUSGÄNGE NICHT DURCH DIE INNEREN SICHERUNGEN DEAKTIVIERT WERDEN**

Sind mehrere Module ABE7 an eine einzige Quelle für API-Ausgänge angeschlossen, so können die Ausgänge beim Ausbauen bzw. Durchbrennen einer Sicherung weiterhin aktiv bleiben.

Zum Deaktivieren der Ausgänge des Moduls bzw. für Wartungsarbeiten am Gerät den API abschalten, alle Spannungsversorgungen sowie den Steckverbinder HE10 abklemmen.

Durch Nichtbeachtung dieser Anweisung kann es zu tödlichen Unfällen, schweren Verletzungen und ernsthaften Schäden an der Ausrüstung kommen.

**ATTENZIONE****I FUSIBILI INTERNI POSSONO NON DISATTIVARE LE USCITE**

Quando parecchi moduli ABE7 sono collegati su un'unica sorgente di uscita di API, le uscite del modulo possono rimanere attive dopo rimozione o fusione di un fusibile interno.

Per disattivare le uscite del modulo o per intraprendere un'operazione di manutenzione sull'apparecchiatura, fermare l'API, scollegare tutte le alimentazioni e scollegare il connettore HE10.

Il mancato rispetto di queste istruzioni può causare la morte, ferite gravi o danni consecutivi sull'apparecchiatura.

**ATENCIÓN****LOS FUSIBLES INTERNOS PUEDEN NO DESACTIVAR LAS SALIDAS**

Cuando varios módulos ABE7 están conectados a una sola fuente de salida de API, las salidas del módulo pueden permanecer activas después del retiro o fusión de un fusible interno.

Para desactivar las salidas del módulo o para emprender una operación de mantenimiento en el aparellaje, parar el API, desconectar todas las alimentaciones y desconectar el conector HE10.

La no observación de estas instrucciones puede causar la muerte, heridas graves o daños consecuentes en el aparellaje.

**ATENÇÃO!****OS FUSÍVEIS INTERNOS PODEM NÃO DESACTIVAR AS SAÍDAS**

Quando vários módulos ABE7 estão conectados numa única fonte de saída do API, as saídas do módulo podem ficar activas depois da retirada ou da fusão de um fusível interno.

Para desactivar as saídas do módulo ou para efectuar uma operação de manutenção na aparelhagem, parar o API, desconectar todas as alimentações e desligar o conector HE10.

O não cumprimento destas instruções pode causar a morte, ferimentos graves ou danos importantes na aparelhagem.

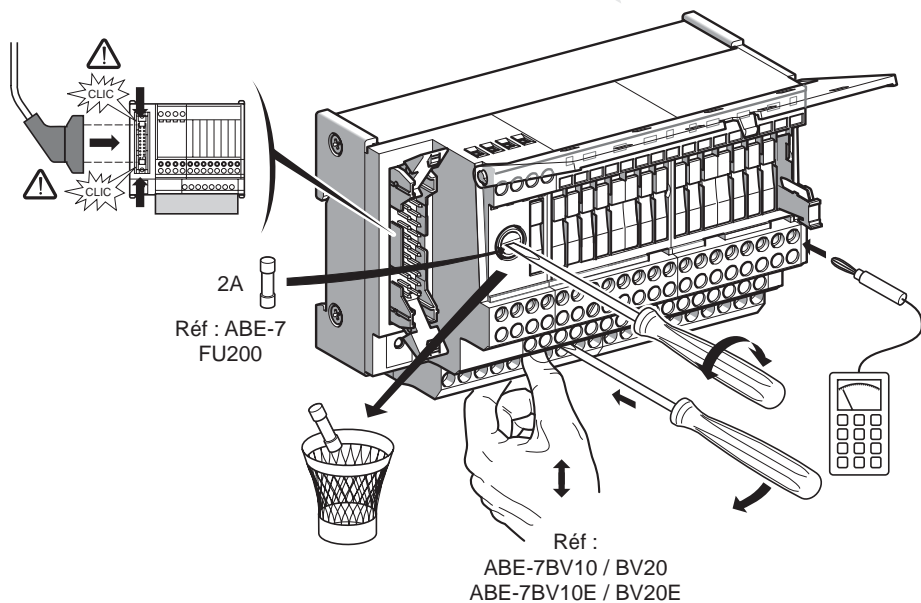

0V ≡

Voies / channels / Kanäle /  
canales / vie / vias

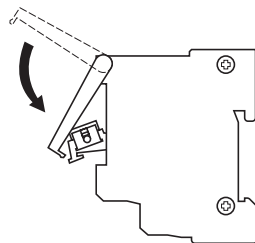
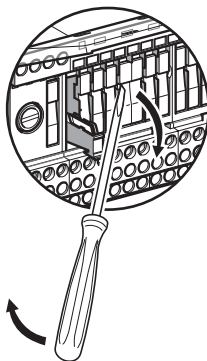
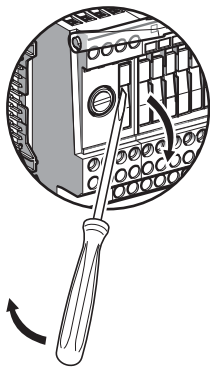

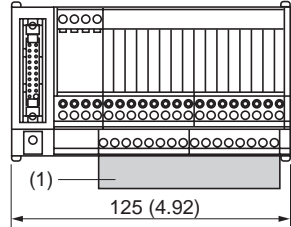
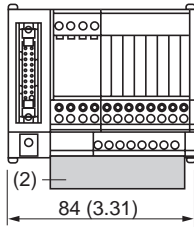
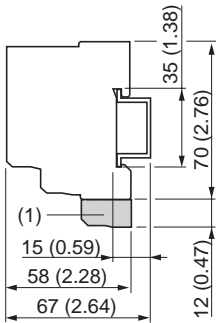

(1) ABE-7BV10 / BV20, ABE-7BV10E / BV20E  
 (2) ABE-7BV10, ABE-7BV10E

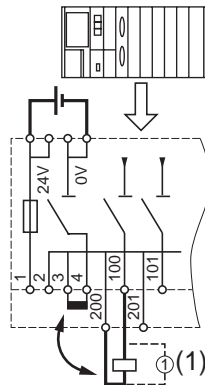
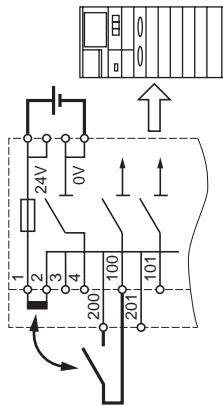

(1) Charge inductive  
 Inductive load  
 Inductive Last  
 Carga inductiva  
 Carica inductiva  
 Carga inductiva

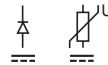

HE10 8 - 12 voies /  
 channels / Kanäle /  
 canales / vie / vias

12 voies / channels  
 8 voies / channels

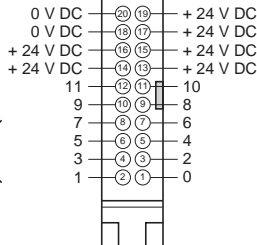

HE10 16 voies /  
 channels / Kanäle /  
 canales / vie / vias

