

**Power Meter 750
Installation Guide
63230-507-200A1**

**English
03/2007**



Additional Resources

Go to www.powerlogic.com, select your country > literature > Power Meters > PM700 > Instructional, and then click the manual you want to download. If you do not have a user name and password, follow the instructions on the web site.

SAFETY PRECAUTIONS

⚠ DANGER

HAZARD OF ELECTRIC SHOCK, EXPLOSION, OR ARC FLASH

- Apply appropriate personal protective equipment (PPE) and follow safe electrical work practices. In the USA, see NFPA 70E.
- Only qualified electrical workers should install this equipment. Such work should be performed only after reading this entire set of instructions.
- NEVER work alone.
- Before performing visual inspections, tests, or maintenance on this equipment, disconnect all sources of electric power. Assume that all circuits are live until they have been completely de-energized, tested, and tagged. Pay particular attention to the design of the power system. Consider all sources of power, including the possibility of backfeeding.
- Turn off all power supplying the power meter and the equipment in which it is installed before working on it.
- Always use a properly rated voltage sensing device to confirm that all power is off.
- Before closing all covers and doors, carefully inspect the work area for tools and objects that may have been left inside the equipment.
- Use caution while removing or installing panels so that they do not extend into the energized bus; avoid handling the panels, which could cause personal injury.
- The successful operation of this equipment depends upon proper handling, installation, and operation. Neglecting fundamental installation requirements may lead to personal injury as well as damage to electrical equipment or other property.
- NEVER bypass external fusing.
- NEVER short the secondary of a PT.
- NEVER open circuit a CT; use the shorting block to short circuit the leads of the CT before removing the connection from the power meter.
- Before performing Dielectric (Hi-Pot) or Megger testing on any equipment in which the power meter is installed, disconnect all input and output wires to the power meter. High voltage testing may damage electronic components contained in the power meter.
- The power meter should be installed in a suitable electrical enclosure.

Failure to follow this instruction will result in death or serious injury

INSTALLATION

Box Contents

- One (1) power meter
- Two (2) retainer clips
- One (1) installation sheet
- One (1) RS485 Terminator (MCT2W)

Parts of the PM750

- Figure 1: PM750**
- ① Control Power.
 - ② Voltage Inputs.
 - ③ Current Inputs.
 - ④ RS-485.
 - ⑤ Digital Inputs / Digital Output connection.
 - ⑥ LED.
Steady = OFF/ON.
Flashing = communications indicator.

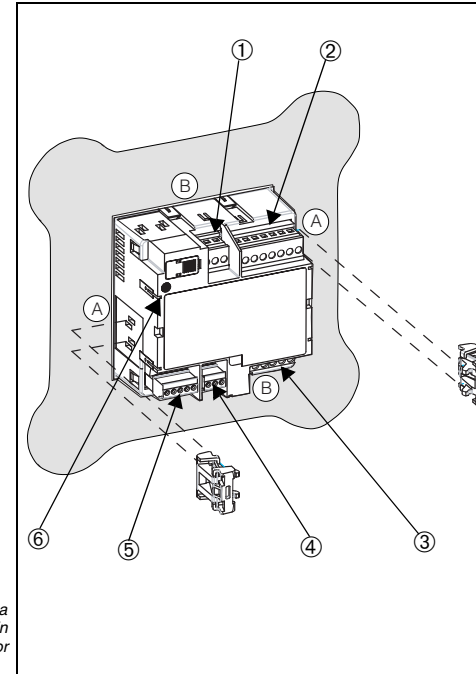

Mounting

1. Insert the power meter through the 92 mm x 92 mm (3.62 in. x 3.62 in.) cut-out (see Figure 2).
 2. Attach the two retainer clips to the power meter using the retainer slots at position **A** or position **B** (shown in drawing on right).
- There are two sets of retainer slots on the left, right, top and bottom of the power meter. The first set is for installation locations 1 to 3 mm (1/8 in.). The second set is for installation locations 3 to 6 mm (1/8 in. to 1/4 in.).

NOTE: For use on a flat surface of a protective enclosure (for example, in the USA: NEMA 1 rated enclosure or better).

Dimensions

Figure 2: PM750 Dimensions

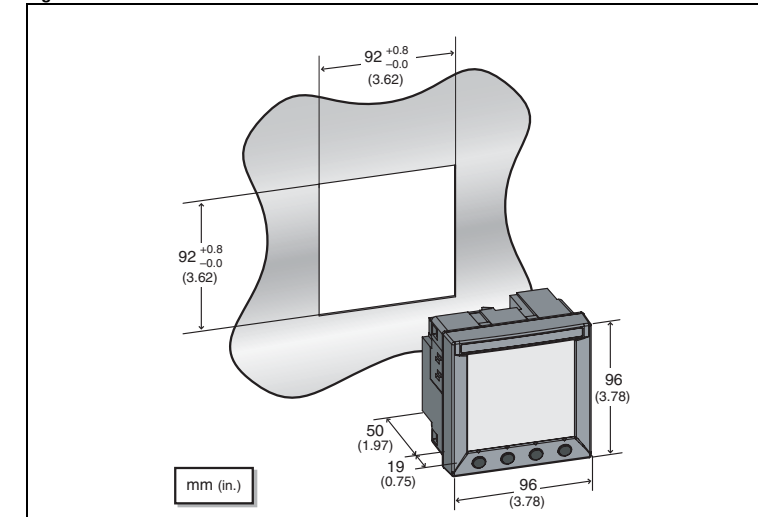

WIRING

NOTE: Voltage inputs and control power for distribution systems up to 277 V L-N and 480 V L-L complies with metering category III. Also, terminal wiring should have a minimum temperature rating of 80°C.

Supported System Types

Table 1: Voltages Less Than or Equal to 277 Vac L-N/480 Vac L-L, Direct Connect No PTs

Number of Wires	CTs		Voltage Connections		Meter Configuration			Figure Number
	Qty.	ID	Qty.	ID	Type	System Type	PT Primary Scale	
Single-Phase Wiring*								
2	1	I1	2	V1, Vn	L-N	10	No PT	3
2	1	I1	2	V1, V2	L-L	11	No PT	4
3	2	I1, I2	3	V1, V2, Vn	L-L with N	12	No PT	5

* Single-phase systems must be connected only as shown in wiring diagrams. Otherwise, meter will not display values.

Table 1: Voltages Less Than or Equal to 277 Vac L-N/480 Vac L-L, Direct Connect No PTs (Continued)

Number of Wires	CTs		Voltage Connections		Meter Configuration			Figure Number
	Qty.	ID	Qty.	ID	Type	System Type	PT Primary Scale	
Three-Phase Wiring								
3	2	I1, I3	3	V1, V2, V3	Delta	30	No PT	6
	3	I1, I2, I3	3	V1, V2, V3	Delta	31	No PT	7
3	1	I1	3	V1, V2, V3	Delta (Balanced)	32	No PT	19
4	3	I1, I2, I3	3	V1, V2, V3, Vn	4-wire Delta	40	No PT	8
4	3	I1, I2, I3	3	V1, V2, V3, Vn	Wye	40	No PT	8
4	1	I1	3	V1, V2, V3, Vn	Wye (Balanced)	44	No PT	20

Table 2: Voltages Greater Than 277 Vac L-N/480 Vac L-L

Number of Wires	CTs		Voltage Connections		Meter Configuration			Figure Number
	Qty.	ID	Qty.	ID	Type	System Type	PT Primary Scale	
3	2	I1, I3	2	V1, V3 (V2 to Ground)	Delta	30	Based on voltage	9
	3	I1, I2, I3	2	V1, V3 (V2 to Ground)	Delta	31	Based on voltage	10
3	1	I1	2	V1, V3 (V2 to Ground)	Delta (Balanced)	32	Based on voltage	18
3	3	I1, I2, I3	3	V1, V2, V3, (Vn to Ground)	Wye (Unbalanced)	40	Based on voltage	11
	2	I1, I2	3	V1, V2, V3, (Vn to Ground)	Wye (Unbalanced)	40	Based on voltage	12
	1	I1	3	V1, V2, V3, (Vn to Ground)	Wye (Unbalanced)	44	Based on voltage	17
4	3	I1, I2, I3	3	V1, V2, V3, (Vn to Ground)	Grounded Wye	40	Based on voltage	13
	3	I1, I2, I3	2	V1, V3 (Vn to Ground)	Wye	42	Based on voltage	14
4	3	I1, I2, I3	3	V1, V2, V3 (Vn to Ground)	Grounded Wye	40	Based on voltage	15
	1	I1	3	V1, V2, V3 (Vn to Ground)	Grounded Wye (Balanced)	44	Based on voltage	16

The following symbols are used in the wiring diagrams:

Table 3: Wiring Diagram Symbols

Symbol	Description
	Voltage disconnect switch
	Fuse
	Earth ground
	Current transformer
	Shorting block
	Potential transformer
	Protection containing a voltage disconnect switch with a fuse or disconnect circuit breaker (the protection device must be rated for the available short-circuit current at the connection point).

Wiring Diagrams

Figure 3: 1-Phase Line-to-Neutral 2-Wire System 1 CT

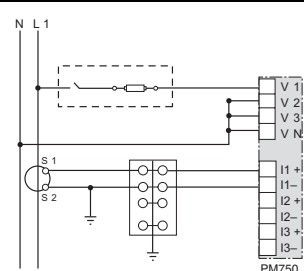

- Use System type 10.
- To avoid distortion, use parallel wires for control power and voltage inputs. Keep the fuse close to the power source.

Figure 4: 1-Phase Line-to-Line 2-Wire System 1 CT

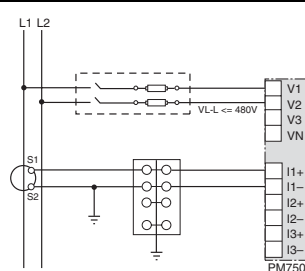

- Use System type 11.
- To avoid distortion, use parallel wires for control power and voltage inputs. Keep the fuse close to the power source.
- Use with 120/240 V systems.

Figure 5: 1-Phase Direct Voltage Connection 2 CT

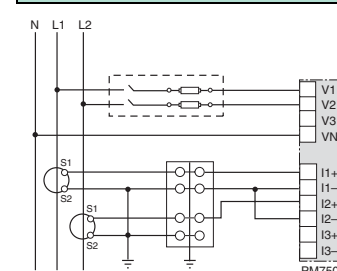

- Use System type 12.
- To avoid distortion, use parallel wires for control power and voltage inputs. Keep the fuse close to the power source.

Figure 7: 3-Phase 3-Wire 3 CT no PT

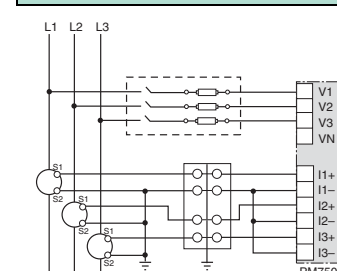

- Use System type 31.

Figure 6: 3-Phase 3-Wire 2 CT no PT

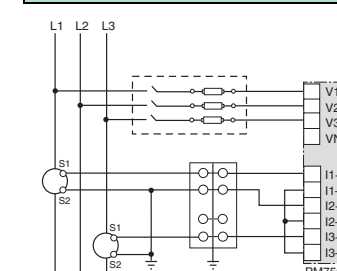

- Use System type 30.

Figure 8: 3-Phase 4-Wire Wye Direct Voltage Input Connection 3 CT

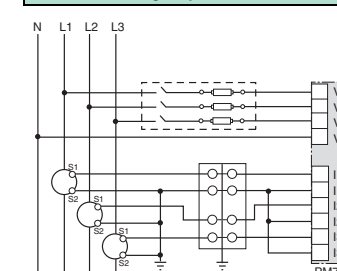

- Use System type 40.
- Use with 480Y/277 V and 208Y/120 V systems.

Figure 9: 3-Phase 3-Wire Delta Connection 2 CT 2 PT

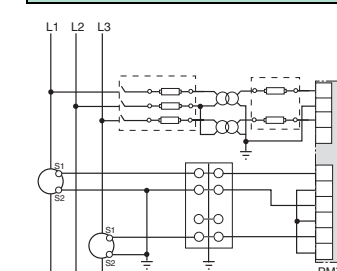

- For an open delta PT connection with 120 V L-L secondaries, use System type 30.

Figure 11: 3-Phase 3-Wire Wye Connection 3 CT 3 PT (unbalanced)

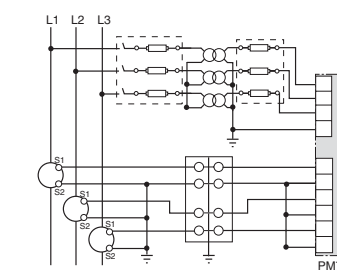

- Use System type 40.

Figure 10: 3-Phase 3-Wire Delta Connection 3CT 2PT

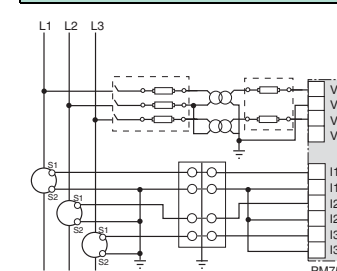

- Use System type 31.
- For an open delta PT connection with 120 V L-L secondaries, use System type 31.

Figure 12: 3-Phase 3-Wire Wye Connection 2CT 3PT (unbalanced)

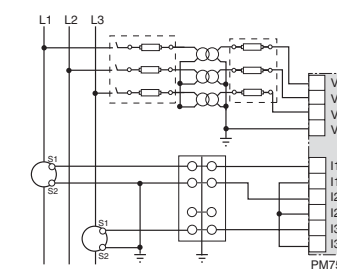

- Use System type 40.

Figure 13: 3-Phase 4-Wire Wye Connection 3 CT 3 PT

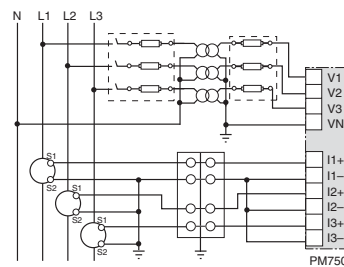

• Use System type 40.

Figure 15: 3-Phase 4-Wire Wye 3 PT 2 CT (for balanced 3-wire loads)

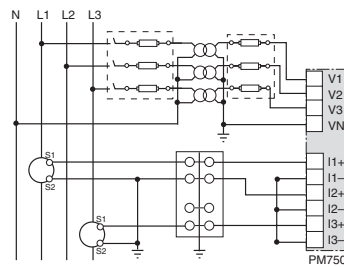

• Use System type 40.

Figure 14: 3-Phase 4-Wire Wye 3CT 2PT (balanced)

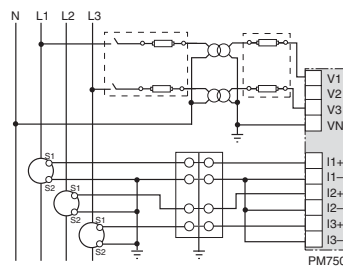

• Use System type 42.

Figure 16: 3-Phase 4-Wire Wye 3PT 1 CT (balanced)

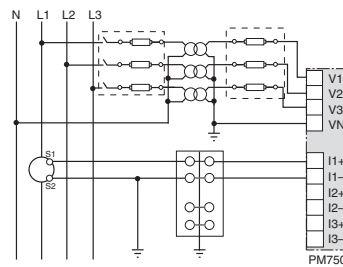

• Use System type 44.

Figure 17: 3-Phase 3-Wire Wye 3PT 1CT (unbalanced)

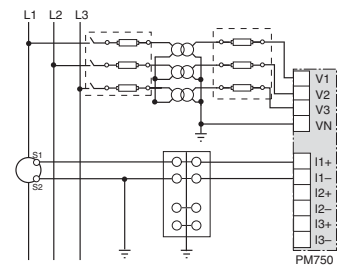

• Use System type 44.

Figure 19: 3-Phase 3-Wire Direct Voltage Input Connection 1 CT (balanced)

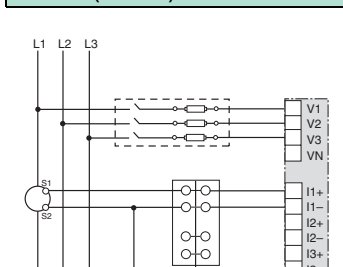

• Use System type 32.

Figure 18: 3-Phase 3-Wire 1 CT 2 PT (balanced)

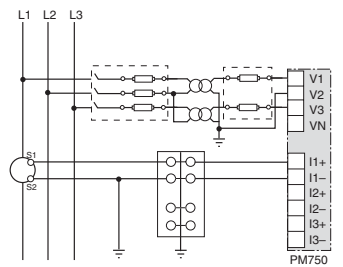

• Use System type 32.

Figure 20: 3-Phase 4-Wire Direct Voltage Input Connection 1 CT (balanced)

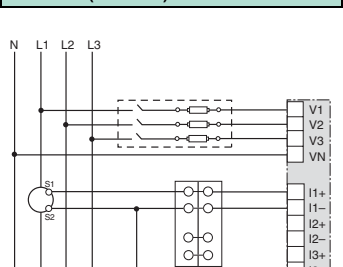

• Use System type 44.

Figure 21: Direct Connect Control Power (Phase to Phase)

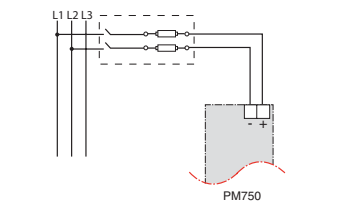

• Phase to Phase only when voltage < 415 + 10% Vac max.
• See Table 4.

Figure 23: Direct Connect Control Power (DC Control Power)

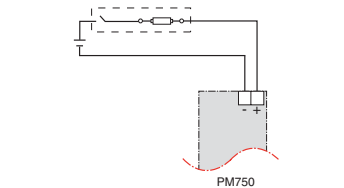

• DC Control Power 100 Vdc < V < 300 Vdc
• See Table 4.

Figure 22: Direct Connect Control Power (Phase to Neutral)

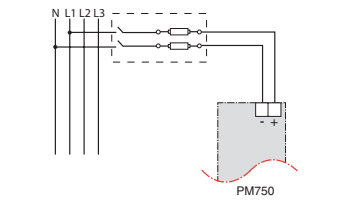

• Phase to Neutral only when voltage < 300 + 10% Vac max.
• See Table 4.

Figure 24: Control Power Transformer (CPT) Connection

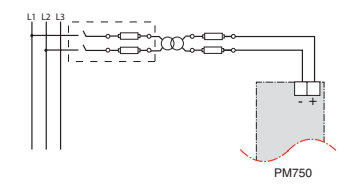

• Control Power Transformer 120 or 240 Vac Secondary 50 Va max.
• See Table 4.

Table 4: Fuse Recommendation

Control Power Source	Source Voltage (V _S)	Fuse	Fuse Amperage
CPT	V _S ≤ 125 V	FNM or MDL	250 mA
CPT	125 < V _S ≤ 240 V	FNQ or FNQ-R	250 mA
CPT	240 < V _S ≤ 305 V	FNQ or FNQ-R	250 mA
Line Voltage	V _S ≤ 240 V	FNQ-R	250 mA

Table 4: Fuse Recommendation (Continued)

Control Power Source	Source Voltage (V _S)	Fuse	Fuse Amperage
Line Voltage	V _S > 240 V	FNQ-R	250 mA
DC	V _S ≤ 300 V	LP-CC	500 mA

NOTES:

- See Figure 21 to Figure 24.
- Over current protection should be located as close to the device as possible.
- For selecting fuses and circuit breakers other than those listed above, use the following criteria:
 - Over current protection should be rated as listed above.
 - Current interrupt capacity should be selected based on the installation category and fault current capability.
 - Over current protection should be selected with a time delay.
 - The voltage rating should be based on the input voltage applied.
- If a 0.25 A fuse is not available with the required fault current capability, use a fuse rated at a maximum of 0.5 A.

INPUT/OUTPUT

The PM750 has two (2) digital inputs and one (1) digital output. The digital inputs have two (2) operating Modes: Normal and Demand Sync.

The digital output has three (3) operating modes: External Control (default), Alarm, and kWh Pulse mode. When configured in Alarm mode, the digital output can be controlled by the meter in response to an alarm condition.

Figure 25: I/O Connections

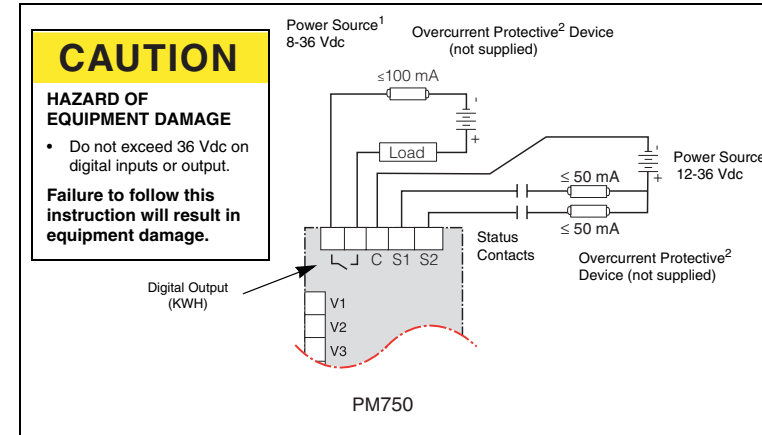

¹Digital inputs and output are not SELV rated.

²The overcurrent protective device must be rated for the short circuit current at the connection point.

COMMUNICATIONS CAPABILITIES

Table 5: RS485 Communications Distances

Baud Rate	Maximum Communication Distances 1 to 32 Devices	
	Feet	Meters
9600	8,000	2,438
19200	6,000	1,829

NOTE: Distances listed should be used as a guide only and cannot be guaranteed for non-POWERLOGIC devices. Refer to the master device's documentation for any additional distance limitations.

Daisy-chaining Devices to the Power Meter

The RS485 slave port allows the power meter to be connected in a daisy chain with up to 31, 2-wire devices. In this document, communications link refers to a chain of devices that are connected by a communications cable.

Figure 26: Daisy-chaining 2-wire devices

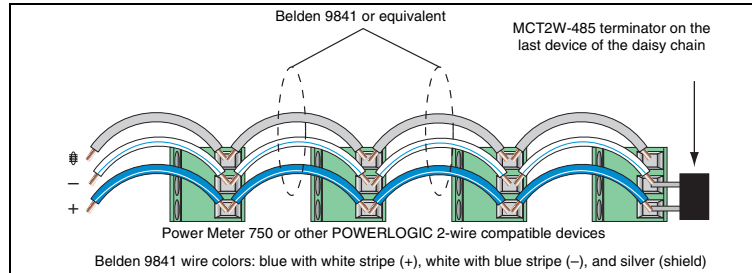

- If the power meter is the first device on the daisy chain, connect it to the host device using a RS232 to RS422/RS485 converter.
- If the power meter is the last device on the daisy chain, terminate it with the terminator provided.
- See Table 5 for the maximum daisy-chain communications distances for 2-wire devices.
- The terminal's voltage and current ratings are compliant with the requirements of the EIA RS485 communications standard.

OPERATING THE DISPLAY

The power meter is equipped with a large, back-lit LCD display. It can display up to five lines of information plus a sixth row of menu options. Figure 27 shows the different parts of the power meter display.

Figure 27: Parts of PM750 Display

- A. Type of measurement
- B. Screen Title
- C. Alarm icon
- D. Maintenance icon
- E. Bar Chart (%)
- F. Units
- G. Display more menu items
- H. Menu item
- I. Selected menu indicator
- J. Button
- K. Return to previous menu
- L. Values
- M. Phase

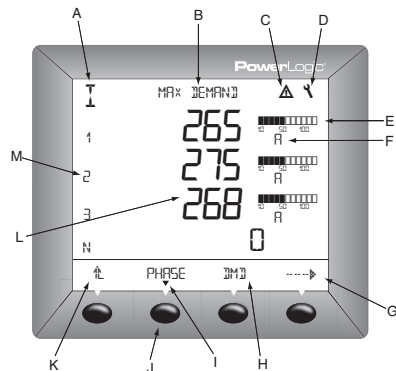

How the Buttons Work

Table 6: Button Symbols

Navigation	
←	View more menu items on the current level.
↶	Return to the previous menu level.
▼	Indicates the menu item is selected and there are no menu levels below the current level.
Change Values	
↕	Change values or scroll through the available options. When the end of a range is reached, pressing + again returns to the first value or option.
←	Select the next number of a series.
OK	Move to the next editable field or exits the screen if the last editable field is selected.

Set Up the Power Meter

Figure 28 shows abbreviated hierarchical relationships of the menu screens for the PM750. Using the Setup Example below in conjunction with the menu hierarchy (Figure 28), complete a minimum setup of the power meter. A minimum setup includes:

- Set up CTs.
- Set up PTs.
- Set up Communication.

Figure 28: PM750 Abbreviated IEC Menu Hierarchy

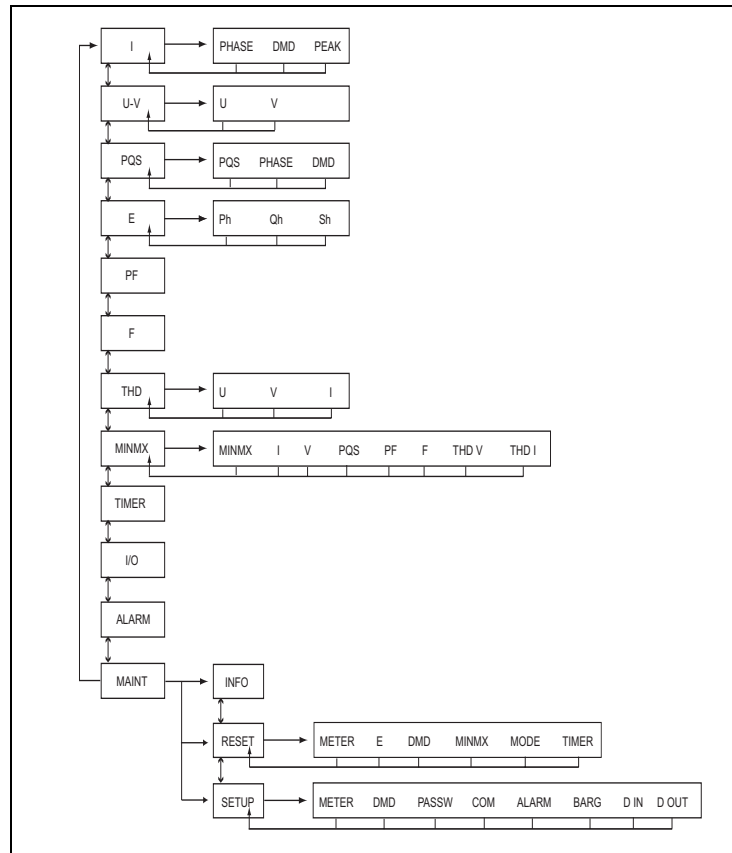

Setup Example: This example shows how to set up CTs. Use the same method to set up PTs and Communication.

1. Press ← until you see MAINT.
2. Press SETUP.
3. Enter your password. The default password is 00000.
4. Press OK.
5. Press METER.
6. Press CT.
7. Enter the PRIM CT (primary CT) number: 1 to 32762.
8. Press OK.
9. Enter the SEC. CT (secondary CT) number: 1 or 5.
10. Press OK.
11. Press ↶ to return to the SETUP MODE screen.

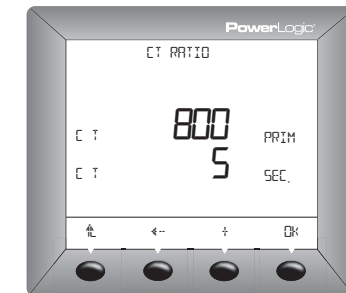

See the online PM750 Reference Guide at www.powerlogic.com for more information on setting up the power meter.

Getting Technical Support

Please refer to the *Technical Support Contacts* provided in the power meter shipping carton or go to www.powerlogic.com, select your country > tech support for support phone numbers by country.

Schneider Electric
Power Monitoring and Control
295 Tech Park Drive, Suite 100
LaVergne, TN 37086
Tel: +1 (615) 287-3400
www.powerlogic.com
www.schneider-electric.com

This product must be installed, connected, and used in compliance with prevailing standards and/or installation regulations. As standards, specifications, and designs change from time to time, please ask for confirmation of the information given in this publication.

63230-507-200A1
© 2007 Schneider Electric. All Rights Reserved.