



**Additional Resources**

Go to [www.powerlogic.com](http://www.powerlogic.com), select your country > literature > Power Meters > PM700 > Instructional, and then click the manual you want to download. If you do not have a user name and password, follow the instructions on the web site.

**SAFETY PRECAUTIONS**

**⚠ DANGER**

**HAZARD OF ELECTRIC SHOCK, EXPLOSION, OR ARC FLASH**

- Apply appropriate personal protective equipment (PPE) and follow safe electrical work practices. In the USA, see NFPA 70E.
- Only qualified electrical workers should install this equipment. Such work should be performed only after reading this entire set of instructions.
- NEVER work alone.
- Before performing visual inspections, tests, or maintenance on this equipment, disconnect all sources of electric power. Assume that all circuits are live until they have been completely de-energized, tested, and tagged. Pay particular attention to the design of the power system. Consider all sources of power, including the possibility of backfeeding.
- Turn off all power supplying the power meter and the equipment in which it is installed before working on it.
- Always use a properly rated voltage sensing device to confirm that all power is off.
- Before closing all covers and doors, carefully inspect the work area for tools and objects that may have been left inside the equipment.
- Use caution while removing or installing panels so that they do not extend into the energized bus; avoid handling the panels, which could cause personal injury.
- The successful operation of this equipment depends upon proper handling, installation, and operation. Neglecting fundamental installation requirements may lead to personal injury as well as damage to electrical equipment or other property.
- NEVER bypass external fusing.
- NEVER short the secondary of a PT.
- NEVER open circuit a CT; use the shorting block to short circuit the leads of the CT before removing the connection from the power meter.
- Before performing Dielectric (Hi-Pot) or Megger testing on any equipment in which the power meter is installed, disconnect all input and output wires to the power meter. High voltage testing may damage electronic components contained in the power meter.
- The power meter should be installed in a suitable electrical enclosure.

**Failure to follow this instruction will result in death or serious injury**

**INSTALLATION**

**Box Contents**

- One (1) power meter
- Two (2) retainer clips
- One (1) installation sheet

**Parts of the PM700P**

Figure 1: PM700P

- ① Control Power.
- ② Voltage Inputs.
- ③ Current Inputs.
- ④ Digital Outputs connection.
- ⑤ LED.
  - Regular flashing = functioning system.
  - Irregular flashing = communications indicator.
  - Steady OFF/ON = meter not functioning.

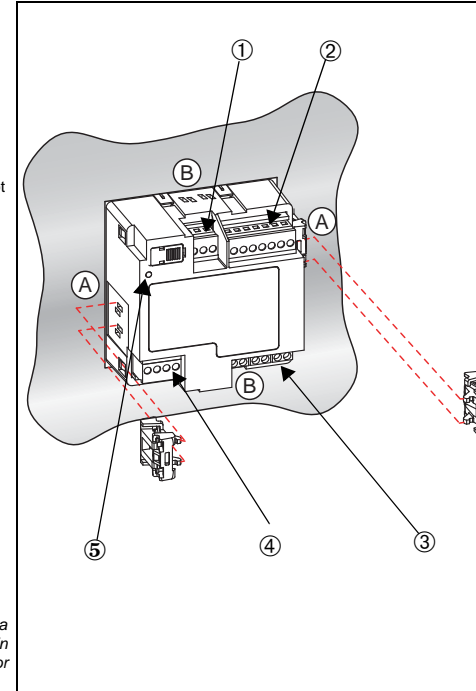

**Mounting**

- Insert the power meter through the 92 mm x 92 mm (3.62 in. x 3.62 in.) cut-out (see Figure 2).
- Attach the two retainer clips to the power meter using the retainer slots at position A or position B (shown in drawing on right). There are two sets of retainer slots on the left, right, top and bottom of the power meter. The first set is for installation locations thinner than 3 mm (1/8 in.). The second set is for installation locations 3 to 6 mm (1/8 in. to 1/4 in.).

NOTE: For use on a flat surface of a protective enclosure (for example, in the USA: NEMA 1 rated enclosure or better).

**Dimensions**

Figure 2: PM700P Dimensions

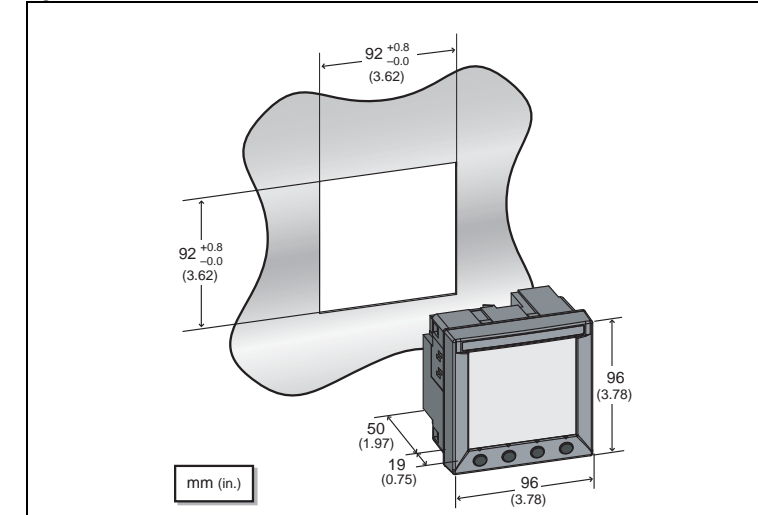

**WIRING**

Voltage inputs and control power for distribution systems up to 277 V L-N and 480 V L-L complies with metering category III. Also, terminal wiring should have a minimum temperature rating of 80° C.

Polarity marks must be followed as shown for CTs (S1=X1, S2=X2) and PTs (■ = X1). See Tables 1 and 4 for connector specifications and wiring symbols.

Table 1: Connector Specifications for PM700P.

	Connection Number	Wire Dimensions	Torque	Insulation Strip Length	
Power Supply	1 and 2	12 to 24 AWG	2.5 to 0.2 mm <sup>2</sup>	4 in•lb / 0.45 N•m	1/4 in / 6.0 mm
Voltage Inputs (PTs)	3, 4, 5, and 6	12 to 24 AWG	2.5 to 0.2 mm <sup>2</sup>	4 in•lb / 0.45 N•m	1/4 in / 6.0 mm
Digital Outputs	7, 8, 9, and 10	12 to 24 AWG	2.5 to 0.2 mm <sup>2</sup>	4 in•lb / 0.45 N•m	1/4 in / 6.0 mm
Current Inputs (CTs)	14, 15, 16, 17, 18, and 19	12 to 24 AWG	2.5 to 0.2 mm <sup>2</sup>	3.54 to 4.43 in•lb / 0.4 to 0.5 N•m	1/4 in / 6.0 mm

NOTE: Connections 11, 12, and 13 are not present on the power meter.

**Supported System Types**

Table 2: Voltages Less Than or Equal to 277 Vac L-N/480 Vac L-L, Direct Connect No PTs

Number of Wires	CTs		Voltage Connections			Meter Configuration		Figure Number
	Qty.	ID	Qty.	ID	Type	System Type	PT Primary Scale	
<b>Single-Phase Wiring*</b>								
2	1	I1	2	V1, Vn	L-N	10	No PT	3
	1	I1	2	V1, V2	L-L	11	No PT	4
3	2	I1, I2	3	V1, V2, Vn	L-L with N	12	No PT	5
* Single-phase systems must be connected only as shown in wiring diagrams. Otherwise, meter will not display values.								
<b>Three-Phase Wiring</b>								
3	2	I1, I3	3	V1, V2, V3	Delta	30	No PT	6
	3	I1, I2, I3	3	V1, V2, V3	Delta	31	No PT	7
	1	I1	3	V1, V2, V3	Delta (Balanced)	32	No PT	19
4	3	I1, I2, I3	3	V1, V2, V3, Vn	4-wire Delta	40	No PT	8
	3	I1, I2, I3	3	V1, V2, V3, Vn	Wye	40	No PT	8
	1	I1	3	V1, V2, V3, Vn	Wye (Balanced)	44	No PT	20

Table 3: Voltages Greater Than 277 Vac L-N/480 Vac L-L

Number of Wires	CTs		Voltage Connections			Meter Configuration		Figure Number
	Qty.	ID	Qty.	ID	Type	System Type	PT Primary Scale	
3	2	I1, I3	2	V1, V3 (V2 to Ground)	Delta	30	Based on voltage	9
	3	I1, I2, I3	2	V1, V3 (V2 to Ground)	Delta	31	Based on voltage	10
	1	I1	2	V1, V3 (V2 to Ground)	Delta (Balanced)	32	Based on voltage	18
3	3	I1, I2, I3	3	V1, V2, V3, (Vn to Ground)	Wye (Unbalanced)	40	Based on voltage	11
	2	I1, I3	3	V1, V2, V3, (Vn to Ground)	Wye (Unbalanced)	40	Based on voltage	12
	1	I1	3	V1, V2, V3, (Vn to Ground)	Wye (Unbalanced)	44	Based on voltage	17

Table 3: Voltages Greater Than 277 Vac L-N/480 Vac L-L

Number of Wires	CTs		Voltage Connections			Meter Configuration		Figure Number
	Qty.	ID	Qty.	ID	Type	System Type	PT Primary Scale	
4	3	I1, I2, I3	3	V1, V2, V3, (Vn to Ground)	Grounded Wye	40	Based on voltage	13
	3	I1, I2, I3	2	V1, V3 (Vn to Ground)	Wye	42	Based on voltage	14
	2	I1, I2, I3	3	V1, V2, V3 (Vn to Ground)	Grounded Wye	40	Based on voltage	15
	1	I1	3	V1, V2, V3 (Vn to Ground)	Grounded Wye (Balanced)	44	Based on voltage	16

The following symbols are used in the wiring diagrams:

Table 4: Wiring Diagram Symbols

Symbol	Description
	Voltage disconnect switch
	Fuse
	Earth ground
	Current transformer. Polarity marks: S1=X1, S2=X2.
	Shorting block
	Potential transformer. Polarity marks: ■ = X1.
	Protection containing a voltage disconnect switch with a fuse or disconnect circuit breaker (the protection device must be rated for the available short-circuit current at the connection point).
	In 2 PT systems, these connections are equivalent. Polarity marks: ■ = X1.

**Wiring Diagrams**

Figure 3: 1-Phase Line-to-Neutral 2-Wire System 1 CT

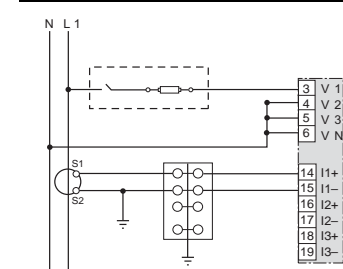

- Use System type 10.
- To avoid distortion, use parallel wires for control power and voltage inputs. Keep the fuse close to the power source.

Figure 4: 1-Phase Line-to-Line 2-Wire System 1 CT

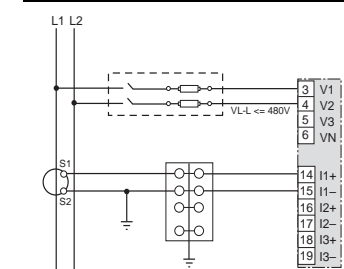

- Use System type 11.
- To avoid distortion, use parallel wires for control power and voltage inputs. Keep the fuse close to the power source.
- Use with 120/240 V systems.

Figure 5: 1-Phase Direct Voltage Connection 2 CT

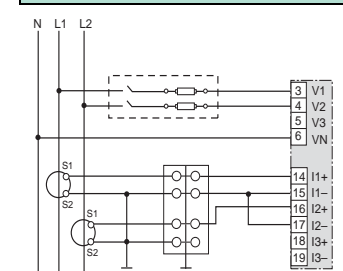

- Use System type 12.
- To avoid distortion, use parallel wires for control power and voltage inputs. Keep the fuse close to the power source.

Figure 6: 3-Phase 3-Wire 2 CT no PT

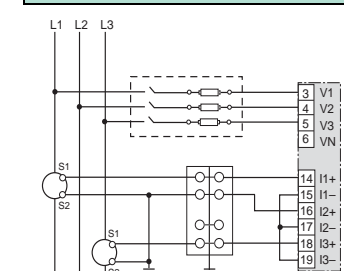

- Use System type 30.

Figure 7: 3-Phase 3-Wire 3 CT no PT

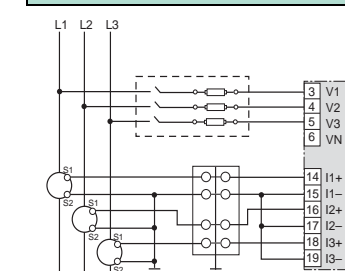

- Use System type 31.

Figure 8: 3-Phase 4-Wire Wye Direct Voltage Input Connection 3 CT

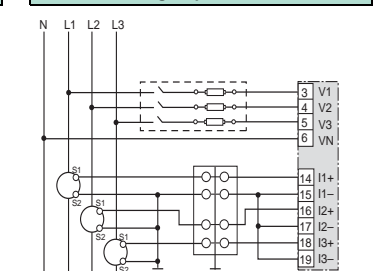

- Use System type 40.
- Use with 480Y/277 V and 208Y/120 V systems.

Figure 9: 3-Phase 3-Wire Delta Connection 2 CT 2 PT

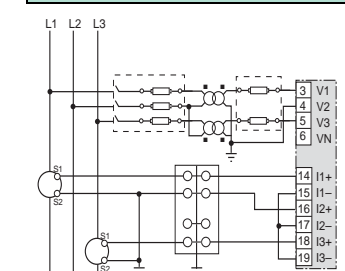

- For an open delta PT connection with 120 V L-L secondaries, use System type 30.

Figure 10: 3-Phase 3-Wire Delta Connection 3CT 2PT

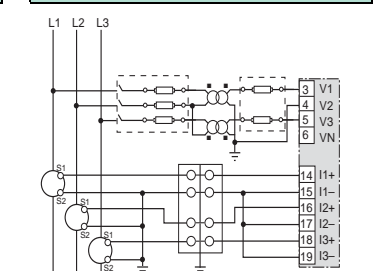

- Use System type 31.
- For an open delta PT connection with 120 V L-L secondaries, use System type 31.

**Figure 11: 3-Phase 3-Wire Wye Connection 3 CT 3 PT (unbalanced)**

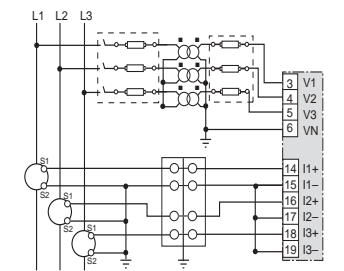

• Use System type 40.

**Figure 12: 3-Phase 3-Wire Wye Connection 2CT 3PT (unbalanced)**

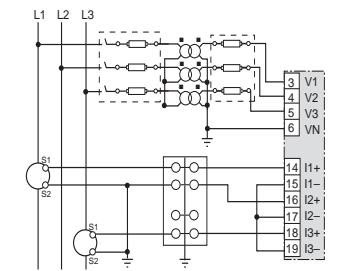

• Use System type 40.

**Figure 13: 3-Phase 4-Wire Wye Connection 3 CT 3 PT**

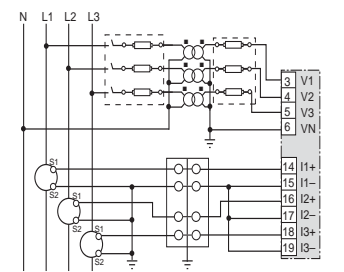

• Use System type 40.

**Figure 14: 3-Phase 4-Wire Wye 3CT 2PT (balanced)**

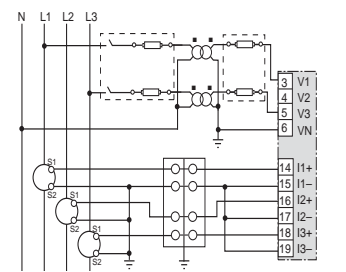

• Use System type 42.

**Figure 15: 3-Phase 4-Wire Wye 2 CT 3 PT (for balanced 3-wire loads)**

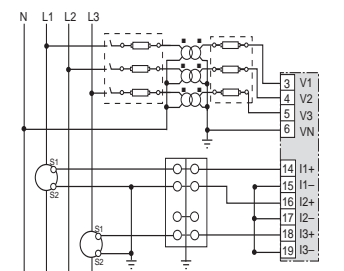

• Use System type 40.

**Figure 16: 3-Phase 4-Wire Wye 1 CT 3PT (balanced)**

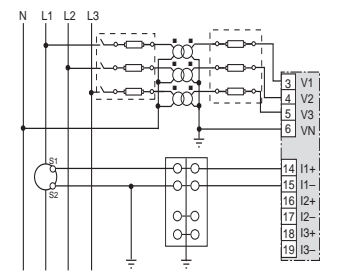

• Use System type 44

**Figure 17: 3-Phase 3-Wire Wye 1CT 3PT (unbalanced)**

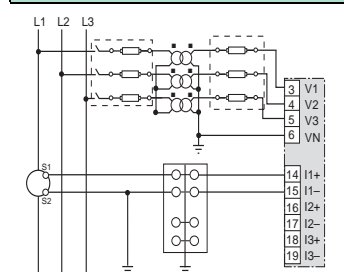

• Use System type 44

**Figure 18: 3-Phase 3-Wire 1 CT 2 PT (balanced)**

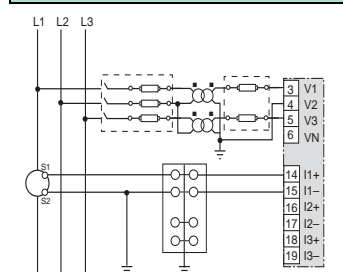

• Use System type 32

**Figure 19: 3-Phase 3-Wire Direct Voltage Input Connection 1 CT (balanced)**

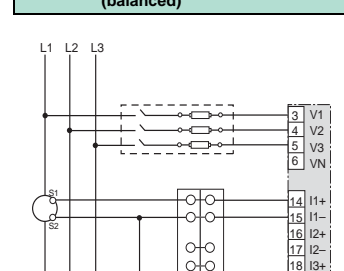

• Use System type 32

**Figure 20: 3-Phase 4-Wire Direct Voltage Input Connection 1 CT (balanced)**

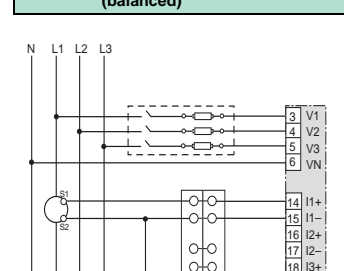

• Use System type 44

**Figure 21: Direct Connect Control Power (Phase to Phase)**

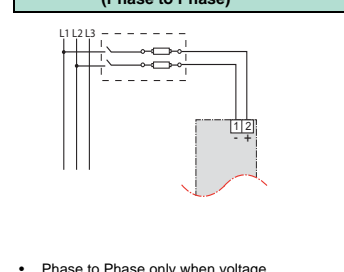

• Phase to Phase only when voltage < 415 + 10% Vac max.  
• See Table 5.

**Figure 22: Direct Connect Control Power (Phase to Neutral)**

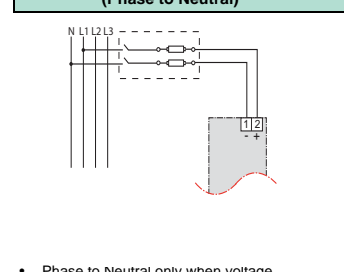

• Phase to Neutral only when voltage < 300 + 10% Vac max.  
• See Table 5.

**Figure 23: Direct Connect Control Power (DC Control Power)**

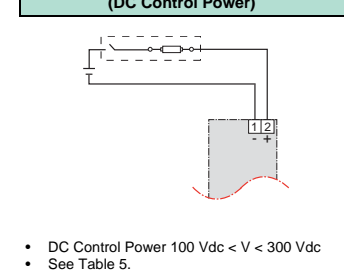

• DC Control Power 100 Vdc < V < 300 Vdc  
• See Table 5.

**Figure 24: Control Power Transformer (CPT) Connection**

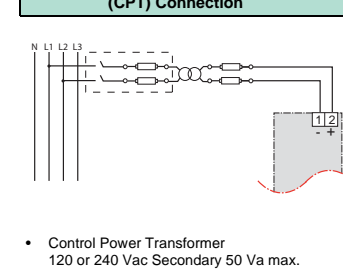

• Control Power Transformer 120 or 240 Vac Secondary 50 Va max.  
• See Table 5.

**Table 5: Fuse Recommendation**

Control Power Source	Source Voltage (V <sub>S</sub> )	Fuse	Fuse Amperage
CPT	V <sub>S</sub> ≤ 25 V	FNM or MDL	250 mA
CPT	125 < V <sub>S</sub> ≤ 240 V	FNQ or FNQ-R	250 mA
CPT	240 < V <sub>S</sub> ≤ 905 V	FNQ or FNQ-R	250 mA
Line Voltage	V <sub>S</sub> ≤ 240 V	FNQ-R	250 mA
Line Voltage	V <sub>S</sub> > 240 V	FNQ-R	250 mA
DC	V <sub>S</sub> ≤ 300 V	LP-CC	500 mA

**NOTES:**

- See Figure 21 to Figure 24.
- Over current protection should be located as close to the device as possible.
- For selecting fuses and circuit breakers other than those listed above, use the following criteria:
  - Over current protection should be rated as listed above.
  - Current interrupt capacity should be selected based on the installation category and fault current capability.
  - Over current protection should be selected with a time delay.
  - The voltage rating should be based on the input voltage applied.
  - If a 0.25 A fuse is not available with the required fault current capability, use a fuse rated at a maximum of 0.5 A.

**Pulse Output Capabilities**

**Solid-state Pulse Output**

There are two solid-state KY outputs. One is dedicated to kWh and the other is dedicated to kVARh.

**Figure 25: Solid-state Outputs**

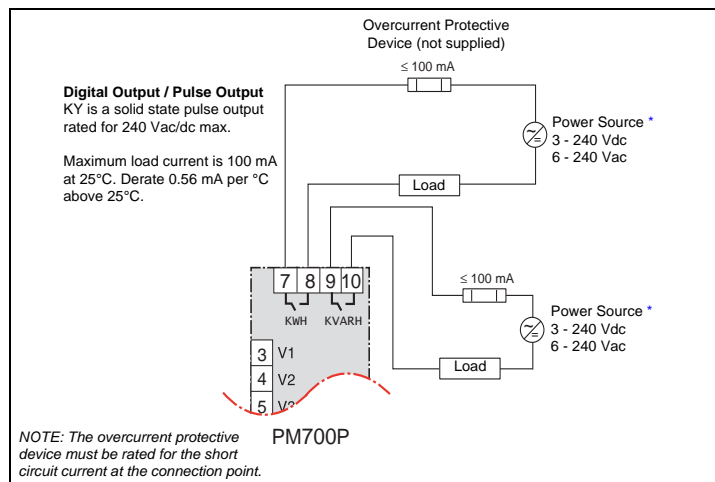

\*The power source should not be a safety extra low voltage (SELV) circuit. Pulse outputs are not SELV rated.

**OPERATING THE DISPLAY**

The power meter is equipped with a large, back-lit LCD display. It can display up to five lines of information plus a sixth row of menu options. Figure 26 shows the different parts of the power meter display.

**Figure 26: Parts of PM700P Display**

- A. Type of measurement
- B. Screen Title
- C. Alarm icon
- D. Maintenance icon
- E. Bar Chart (%)
- F. Units
- G. Display more menu items
- H. Menu item
- I. Selected menu indicator
- J. Button
- K. Return to previous menu
- L. Values
- M. Phase

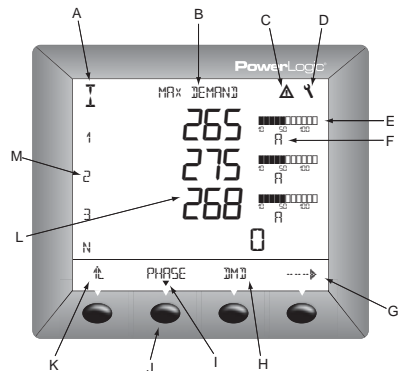

**How the Buttons Work**

**Table 6: Button Symbols**

Navigation	
←→	View more menu items on the current level.
⬅	Return to the previous menu level.
⬇	Indicates the menu item is selected and there are no menu levels below the current level.
Change Values	
⬆	Change values or scroll through the available options. When the end of a range is reached, pressing + again returns to the first value or option.
⬅	Select the next number of a series.
⏹	Move to the next editable field or exits the screen if the last editable field is selected.

**Set Up the Power Meter**

Figure 27 shows abbreviated hierarchical relationships of the menu screens for the PM700P. Using the Setup Example below in conjunction with the menu hierarchy (Figure 27), complete a minimum setup of the power meter. A minimum setup includes:

- Set up CTs.
- Set up PTs.
- Set I/O.

**Figure 27: PM700P Abbreviated IEC Menu Hierarchy\***

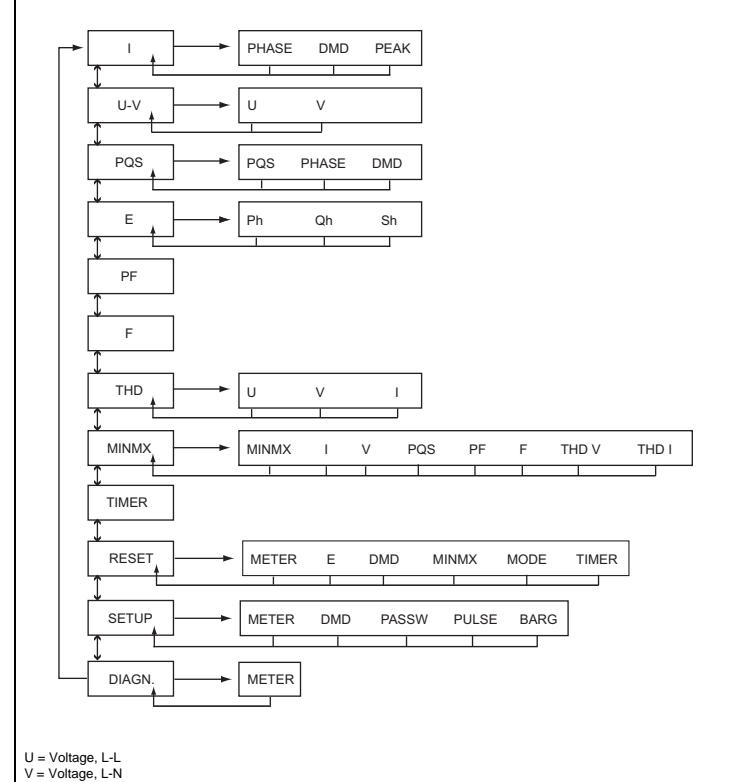

\*The power meter can be configured to display either IEC or IEEE nomenclature. Figure 27 shows IEC nomenclature.

**Setup Example:** This example shows how to set up CTs. Use the same method to set up PTs and Communication.

1. Press ←→ until you see SETUP.
2. Press SETUP.
3. Enter your password. The default password is 00000.
4. Press OK.
5. Press METER.
6. Press CT.
7. Enter the PRIM CT (primary CT) number: 1 to 32762.
8. Press OK.
9. Enter the SEC. CT (secondary CT) number: 1 or 5.
10. Press OK.
11. Press ⬅ to return to the SETUP MODE screen.

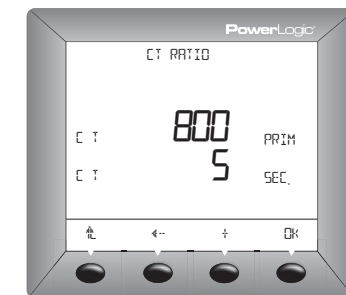

See the online PM700P Reference Guide at [www.powerlogic.com](http://www.powerlogic.com) for more information on setting up the power meter.

**Getting Technical Support**

Please refer to the *Technical Support Contacts* provided in the power meter shipping carton or go to [www.powerlogic.com](http://www.powerlogic.com), select your country > tech support for support phone numbers by country.

Schneider Electric  
Power Monitoring and Control  
295 Tech Park Drive, Suite 100  
LaVergne, TN 37086 USA  
Tel: +1 (615) 287-3400  
[www.powerlogic.com](http://www.powerlogic.com)

This product must be installed, connected, and used in compliance with prevailing standards and/or installation regulations. As standards, specifications, and designs change from time to time, please ask for confirmation of the information given in this publication.

63230-501-205A1  
© 2008 Schneider Electric. All Rights Reserved.