

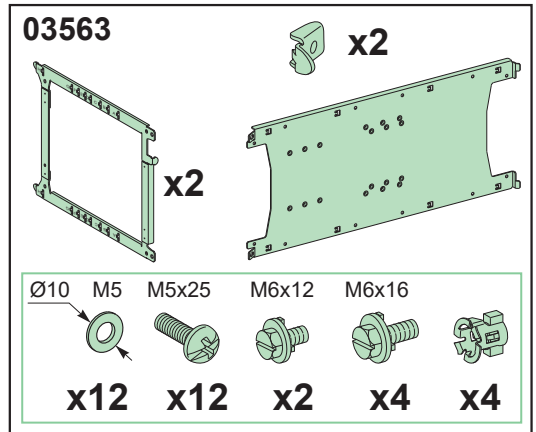

en fr es de it pt zh ru

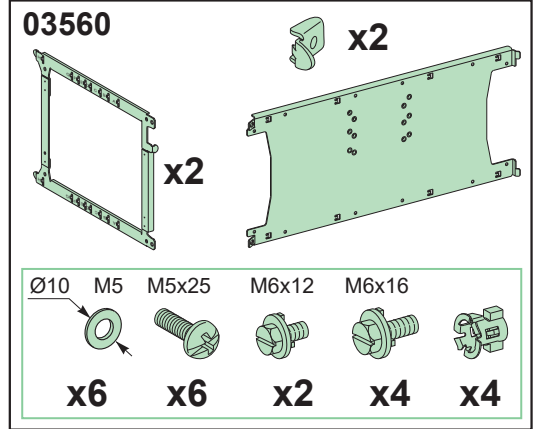
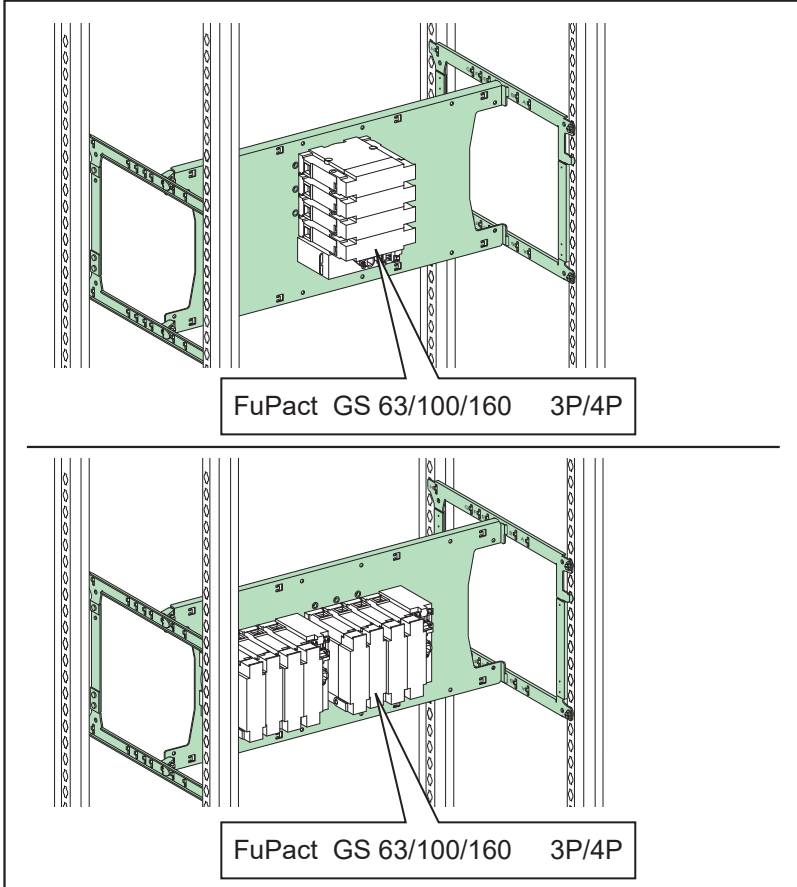
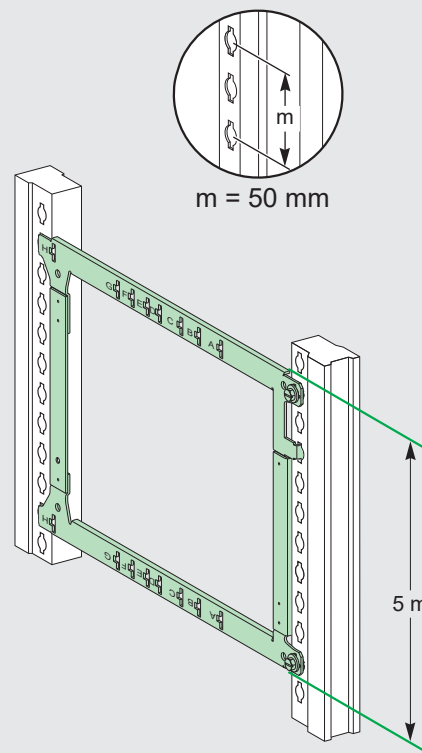
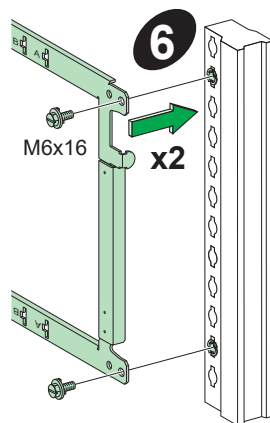
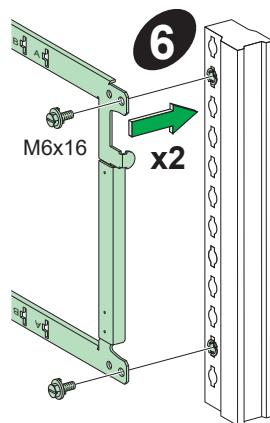
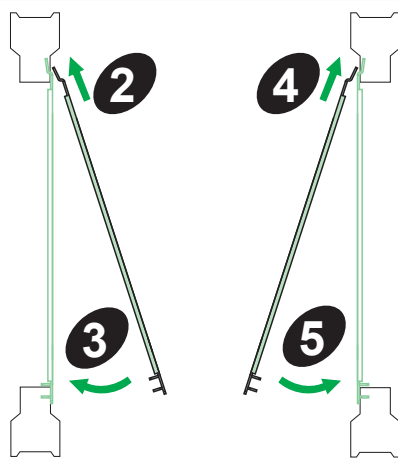
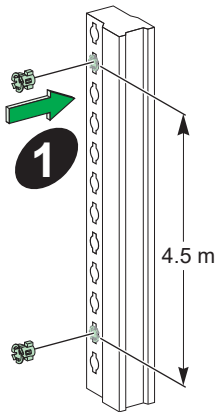
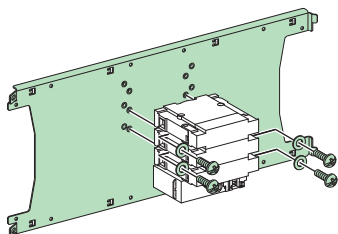
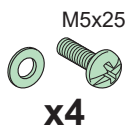

| | | | |
|--|--|--|--|
| <p>PLEASE NOTE Electrical equipment should be installed, operated, serviced, and maintained only by qualified personnel. No responsibility is assumed by Schneider Electric for any consequences arising out of the use of this material.</p> | <p>REMARQUE IMPORTANTE L'installation, l'utilisation, la réparation et la maintenance des équipements électriques doivent être assurées par du personnel qualifié uniquement. Schneider Electric décline toute responsabilité quant aux conséquences de l'utilisation de ce matériel.</p> | <p>TENGA EN CUENTA La instalación, manejo, puesta en servicio y mantenimiento de equipos eléctricos deberán ser realizados sólo por personal cualificado. Schneider Electric no se hace responsable de ninguna de las consecuencias del uso de este material.</p> | <p>BITTE BEACHTEN Elektrische Geräte dürfen nur von Fachpersonal installiert, betrieben, bedient und gewartet werden. Schneider Electric haftet nicht für Schäden, die durch die Verwendung dieses Materials entstehen.</p> |
| <p>NOTA Manutenzione, riparazione, installazione e uso delle apparecchiature elettriche si devono affidare solo a personale qualificato. Schneider Electric non si assume alcuna responsabilità per qualsiasi conseguenza derivante dall'uso di questo materiale.</p> | <p>NOTA A instalação, utilização e manutenção do equipamento eléctrico devem ser efectuadas exclusivamente por pessoal qualificado. A Schneider Electric não assume qualquer responsabilidade pelas consequências resultantes da utilização deste material.</p> | <p>请注意 电气设备的安装、操作、维修和维护工作仅限于合格人员执行。Schneider Electric 不承担由于使用本资料所引起的任何后果。</p> | <p>ОБРАТИТЕ ВНИМАНИЕ Установка, эксплуатация, ремонт и обслуживание электрического оборудования может выполняться только квалифицированными электриками. Компания Schneider Electric не несет никакой ответственности за любые возможные последствия использования данной документации.</p> |

A**B****03560**

GS 63 3P

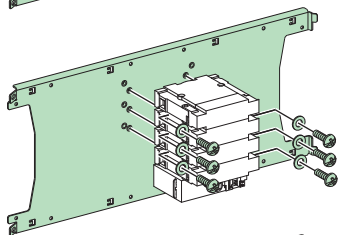
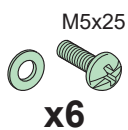
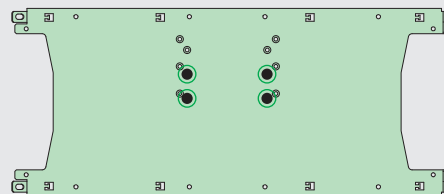
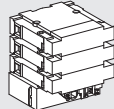

GS 63 4P

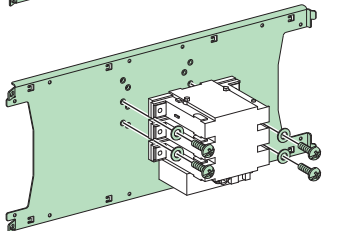
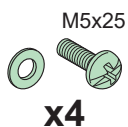
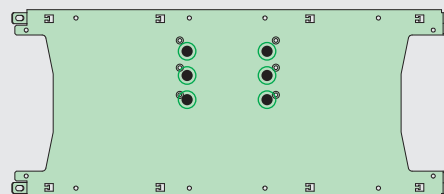
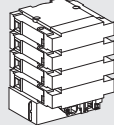

GS 100/160 3P

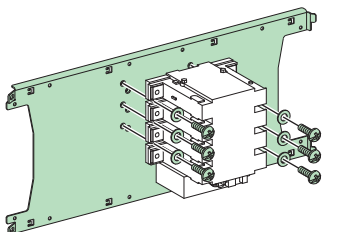
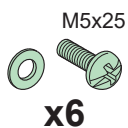
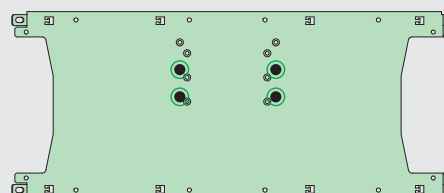
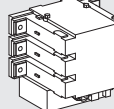

GS 100/160 4P

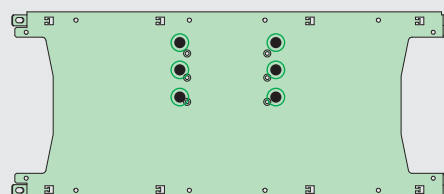
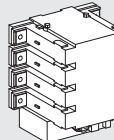

B'

03563

M5x25



x8

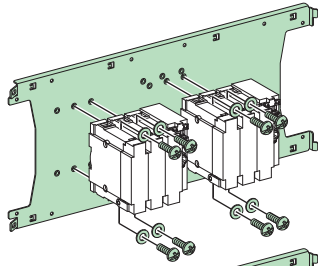

M5x25

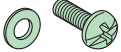

x12

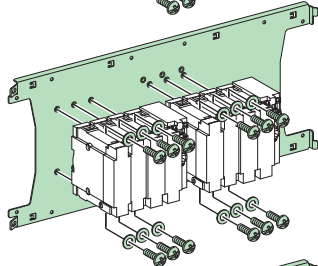

M5x25



x4

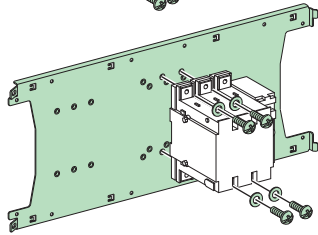

M5x25

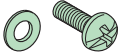

x6

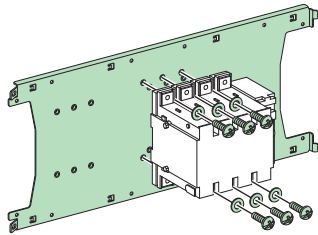

GS 63 3P

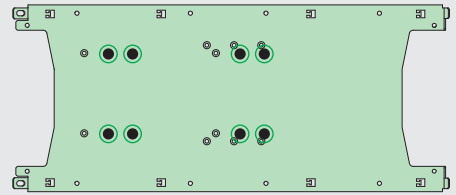
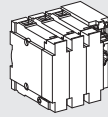

GS 63 4P

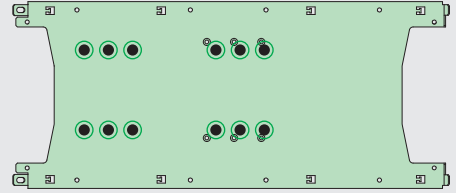
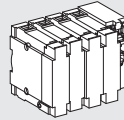

GS 100/160 3P

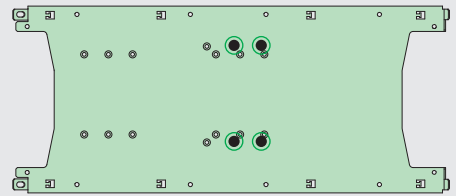
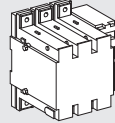

GS 100/160 4P

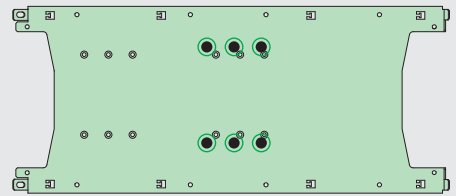
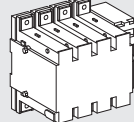

C

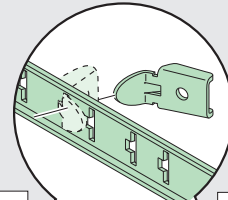
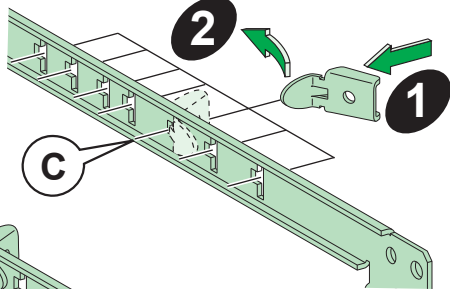
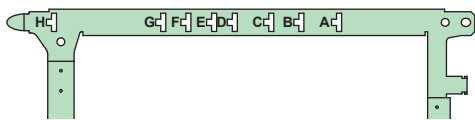

D

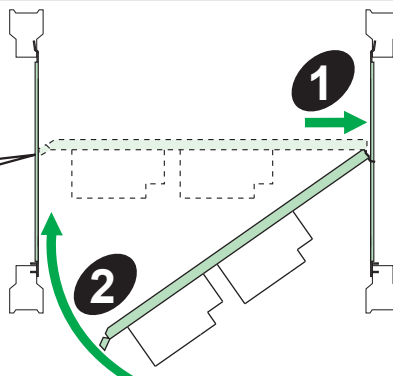
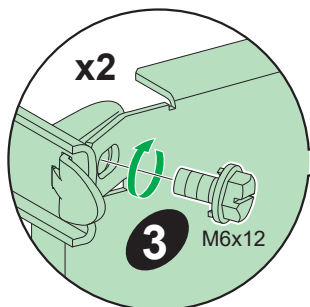



03560 / 03563

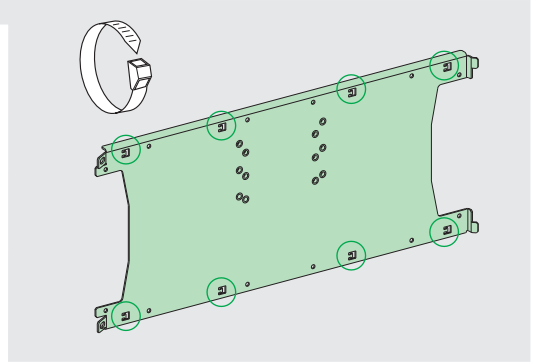
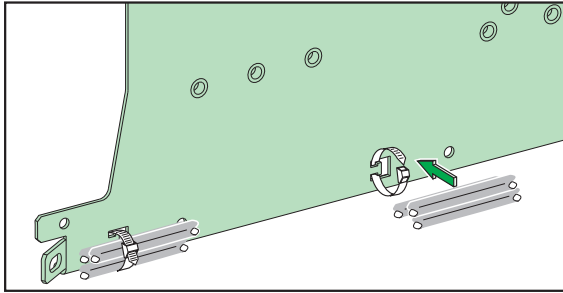

GS2AE2 /
GS2AE21 /
GS2AE22

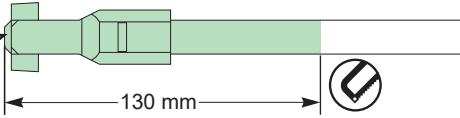

GS 63 3P/4P

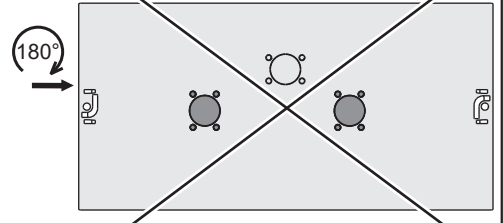
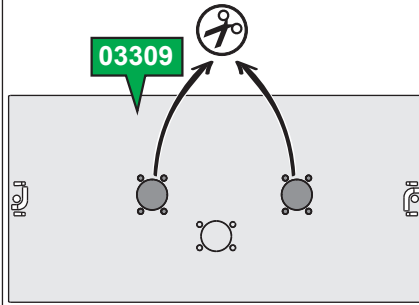
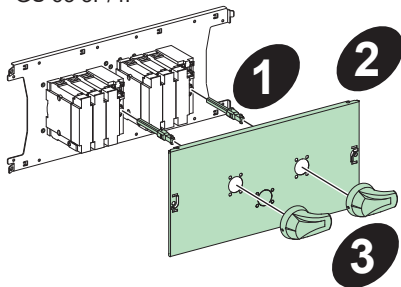

GS 63 3P/4P

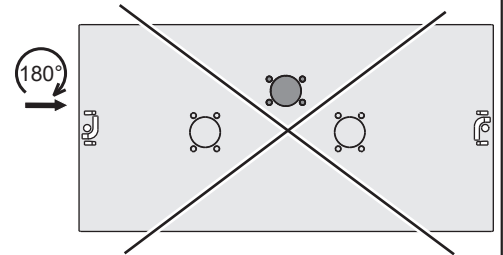
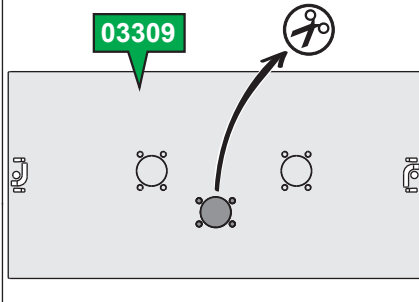
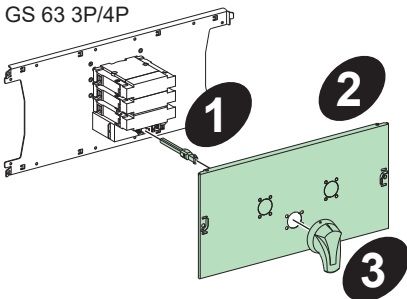

GS 100/160 3P

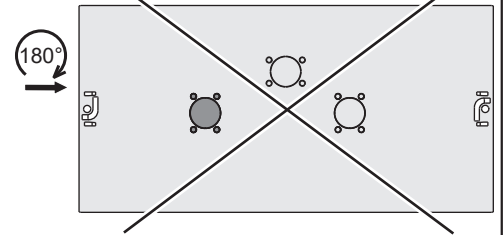
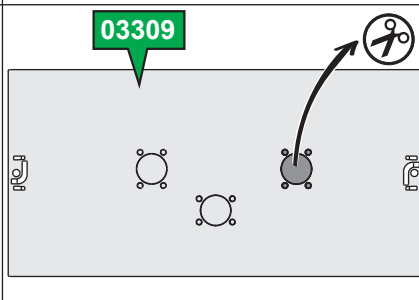
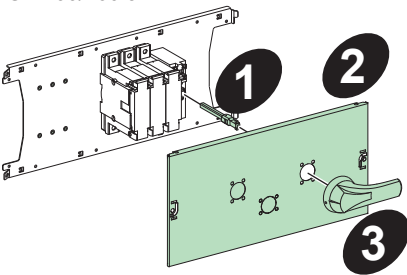

GS 100/160 3P

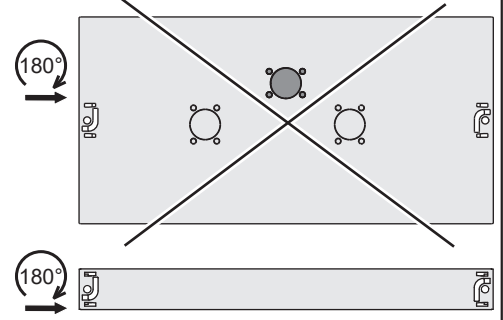
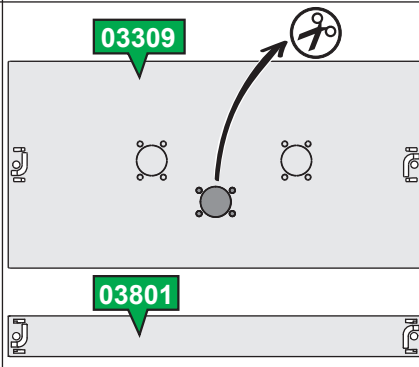
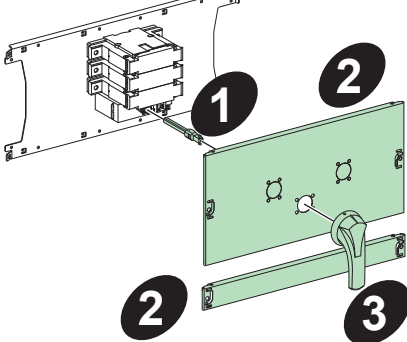

Schneider Electric Industries SAS

35, rue Joseph Monier
92506 Rueil Malmaison
France

www.se.com

04696507AA-01

En raison de l'évolution des normes et du matériel, les caractéristiques indiquées par le texte et les images de ce document ne nous engageant qu'après confirmation par nos services.

As standards, specifications and designs change from time to time, please ask for confirmation of the information given in this publication.

Publication : Schneider Electric
Réalisation : Schneider Electric
Impression :
Format de pliage : 210x297 mm

© 2021 Schneider Electric - All rights reserved.



Ce document a été imprimé sur du papier écologique.

This document has been printed on ecological paper

02/2021