

CERTIFICATE OF CONFORMITY



Equipment : UPS
Brand Name : 
Test Model No. : SRT3000RMXLW-IEC
Multiple Listing : SRT3000XLT, SRT3000RMXLT, SRT3000XLW-IEC
Applicant : American Power Conversion Holding Inc, Taiwan Branch
Test Report No. : FV150428D11

We, **Bureau Veritas Consumer Products Services (H.K.) Ltd., Taoyuan Branch**, declare that the equipment above has been tested in our facility and found compliance with the requirement limits of applicable standards. The test record, data evaluation and Equipment Under Test (EUT) configurations represented herein are true and accurate under the standards herein specified.

47 CFR FCC Part 15, Subpart B, Class A

ICES-003:2012 Issue 5, Class A

ANSI C63.4:2009

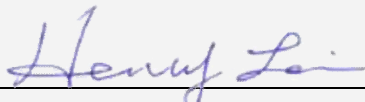

Henry Lai / Director

May 15, 2015

No. 47-2, 14th Ling, Chia Pau Vil., Lin Kou Dist., New Taipei City 244, Taiwan (R.O.C.)

Tel: 886-2-26052180 Fax: 886-2-26051924

<http://www.bureauveritas-adt.com> E-Mail: service.adt@tw.bureauveritas.com





A D T

FCC Verification Test Report

Report No.: FV150428D11

Test Model : SRT3000RMXLW-IEC

Series Model: SRT3000XLT, SRT3000RMXLT, SRT3000XLW-IEC

Received Date: Apr. 28, 2015

Test Date: Apr. 30 ~ May 6, 2015

Issued Date: May 15, 2015

Applicant: American Power Conversion Holding Inc, Taiwan Branch

Address: 3F, No. 205, Sec. 3, Beishin Rd., Shindian City, Taipei, Taiwan 231, R.O.C.

Issued By: Bureau Veritas Consumer Products Services (H.K.) Ltd., Taoyuan Branch

Lab Address: No. 47-2, 14th Ling, Chia Pau Vil., Lin Kou Dist., New Taipei City, Taiwan (R.O.C.)



This report is for your exclusive use. Any copying or replication of this report to or for any other person or entity, or use of our name or trademark, is permitted only with our prior written permission. This report sets forth our findings solely with respect to the test samples identified herein. The results set forth in this report are not indicative or representative of the quality or characteristics of the lot from which a test sample was taken or any similar or identical product unless specifically and expressly noted. Our report includes all of the tests requested by you and the results thereof based upon the information that you provided to us. You have 60 days from date of issuance of this report to notify us of any material error or omission caused by our negligence, provided, however, that such notice shall be in writing and shall specifically address the issue you wish to raise. A failure to raise such issue within the prescribed time shall constitute your unqualified acceptance of the completeness of this report, the tests conducted and the correctness of the report contents. Unless specific mention, the uncertainty of measurement has been explicitly taken into account to declare the compliance or non-compliance to the specification. The report must not be used by the client to claim product certification, approval, or endorsement by NVLAP, NIST, or any agency of the federal government. The report must not be used by the client to claim product certification, approval, or endorsement by TAF or any government agencies.

Table of Contents

Release Control Record	3
1 Certificate of Conformity	4
2 Summary of Test Results	5
2.1 Measurement Uncertainty.....	5
2.2 Modification Record.....	5
3 General Information	6
3.1 Features of EUT.....	6
3.2 General Description of EUT.....	6
3.3 Operating Modes of EUT and Determination of Worst Case Operating Mode.....	7
3.4 Test Program Used and Operation Descriptions	7
4 Configuration and Connections with EUT	8
4.1 Connection Diagram of EUT and Peripheral Devices	8
4.2 Configuration of Peripheral Devices and Cable Connections.....	9
5 Conducted Emissions at Mains Ports	10
5.1 Limits	10
5.2 Test Instruments.....	10
5.3 Test Arrangement.....	11
5.4 Test Results (1)	12
5.5 Test Results (2)	14
5.6 Test Results (3)	16
6 Radiated Emissions up to 1 GHz	18
6.1 Limits	18
6.2 Test Instruments.....	19
6.3 Test Arrangement.....	20
6.4 Test Results (1)	21
6.5 Test Results (2)	23
6.6 Test Results (3)	25
7 Pictures of Test Arrangements	27
7.1 Conducted Emissions at Mains Ports.....	27
7.2 Radiated Emissions up to 1 GHz.....	28
Appendix – Information on the Testing Laboratories	29



Release Control Record

Issue No.	Description	Date Issued
FV150428D11	Original release.	May 15, 2015



1 Certificate of Conformity

Product: UPS

Brand: 
by Schneider Electric

Test Model : SRT3000RMXLW-IEC

Series Model: SRT3000XLT, SRT3000RMXLT, SRT3000XLW-IEC

Sample Status: Engineering sample

Applicant: American Power Conversion Holding Inc, Taiwan Branch

Test Date: Apr. 30 ~ May 6, 2015

Standards: 47 CFR FCC Part 15, Subpart B, Class A
ICES-003:2012 Issue 5, Class A
ANSI C63.4:2009

The above equipment has been tested by **Bureau Veritas Consumer Products Services (H.K.) Ltd., Taoyuan Branch**, and found compliance with the requirement of the above standards. The test record, data evaluation & Equipment Under Test (EUT) configurations represented herein are true and accurate accounts of the measurements of the sample's EMC characteristics under the conditions specified in this report.

Prepared by : 
_____, **Date:** May 15, 2015
Sandra Lin / Specialist

Approved by : 
_____, **Date:** May 15, 2015
Henry Lai / Director



2 Summary of Test Results

47 CFR FCC Part 15, Subpart B / ICES-003:2012 Issue 5, Class A

ANSI C63.4:2009

FCC Clause	ICES-003 Clause	Test Item	Result/Remarks	Verdict
15.107	6.1	AC Power Line Conducted Emissions	Minimum passing Class A margin is -6.74 dB at 0.15129 MHz	Pass
15.109	6.2.1	Radiated Emissions up to 1 GHz	Minimum passing Class A margin is -5.52 dB at 169.53 MHz	Pass
	6.2.2	Radiated Emissions above 1 GHz	EUT's highest frequency is below 108MHz	N/A

Note:

1. There is no deviation to the applied test methods and requirements covered by the scope of this report.
2. N/A: Not Applicable

2.1 Measurement Uncertainty

Where relevant, the following measurement uncertainty levels have been estimated for tests performed on the EUT:

The listed uncertainties are the worst case uncertainty for the entire range of measurement. Please note that the uncertainty values are provided for informational purposes only and are not used in determining the PASS/FAIL results.

Measurement	Frequency	Expanded Uncertainty (k=2) (±)
Conducted Emissions at mains ports	150kHz ~ 30MHz	3.43 dB
Radiated Emissions up to 1 GHz	30MHz ~ 1GHz	4.26 dB

2.2 Modification Record

There were no modifications required for compliance.

3 General Information

3.1 Features of EUT

The tests reported herein were performed according to the method specified by American Power Conversion Holding Inc, Taiwan Branch, for detailed feature description, please refer to the manufacturer's specifications or user's manual.

3.2 General Description of EUT

Product	UPS
Brand	 by Schneider Electric
Test Model	SRT3000RMXLW-IEC
Series Model	SRT3000XLT, SRT3000RMXLT, SRT3000XLW-IEC
Sample Status	Engineering sample
Operating Software	UPS k04.4
Operating Hardware	HW02b_2015_MAR25
Power Supply Rating	Switching Rating: refer to note below Power Cord: Non-shielded AC 3-pin (2.0m)
Data Cable Supplied	Non-Shielded RS-232 cable (5.0m) Shielded USB cable (2.0m) Shielded USB cable (5.0m)

Note:

- The EUT is an Uninterruptible Power Systems, which has several models with difference, as follows:

Model No.	AC I/P	AC O/P
SRT3000RMXLW-IEC	208V, 16A, 50/60Hz	2700W
SRT3000XLT		
SRT3000RMXLT		
SRT3000XLW-IEC		

During the test, the Model No.: **SRT3000RMXLW-IEC** was selected as the representative one for the test and therefore only its test data were recorded in this report.

- The EUT consumes power from a battery pack, which has several models could be chosen, as the following:

Brand	Model	Specification
 by Schneider Electric	SRT96BP	APC Smart-UPS SRT 96V 3000VA LV/HV Battery pack
	SRT96RMBP	

3.3 Operating Modes of EUT and Determination of Worst Case Operating Mode

Test modes are presented in the report as below.

Test Item	Test Mode	Model No.	Test Condition	Input Power
Conducted emission, Radiated emission tests	Mode 1	SRT3000RMXLW-IEC	Online mode	208V/ 60Hz
	Mode 2		Green mode	
	Mode 3		Battery mode	

3.4 Test Program Used and Operation Descriptions

- a. Connected NB with EUT via USB cable and RJ45 to RS232 cable.
- b. Set EUT under online mode or green mode or battery mode continuously.
- c. Turned on the power of all equipment.
- d. Notebook ran a test program to enable all functions.
- e. Notebook read and wrote messages from HDD and ext.HDD.
- f. Notebook sent “H” messages to panel and then panel displayed “H” patterns on its screen.
- g. EUT sent and received messages to/from Notebook (kept in a remote area) with Wireless Broadband Router via an UTP LAN cable (10m).
- h. Notebook run “short to ulSim-TreeView.BAT” via RS-232.
- i. Notebook keeps watch on Notebook’s device manager “APC UPS” via USB.
- j. Universal’s sensor keep watch on environment temperature.
- k. Notebook sent messages to printer, and then printer printed it out.
- l. After test check EPO function.
- m. Steps e-l were repeated.

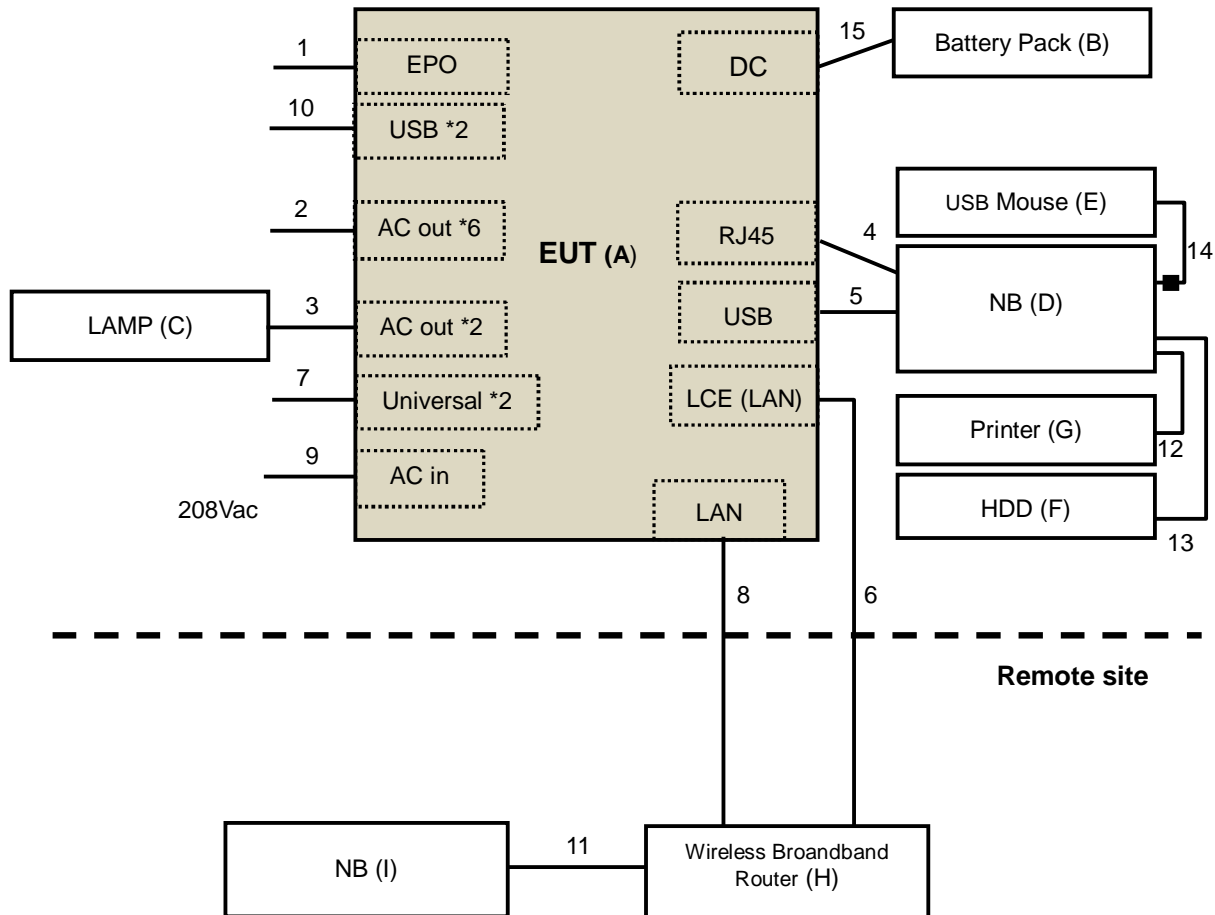

4 Configuration and Connections with EUT

4.1 Connection Diagram of EUT and Peripheral Devices





4.2 Configuration of Peripheral Devices and Cable Connections

ID	Product	Brand	Model No.	Serial No.	FCC ID	Remarks
A.	EUT		SRT3000RMXLW-IEC	QS1430242314	N/A	Supplied by client
B.	Battery Pack		SRT96RMBP	5A1430T02143	N/A	Supplied by client
C.	LAMP	N/A	N/A	N/A	N/A	Supplied by client
D.	NB	DELL	PP18L	N/A	FCC DoC Approved	Supplied by client
E.	USB Mouse	Microsoft	1113	9170515896637	FCC DoC Approved	Provided by Lab
F.	USB 3.0 Hard Disk	WD	WDBACY5000ABL -PESN	WX11E91ED733	FCC DoC Approved	Provided by Lab
G.	PRINTER	LEXMARK	Z33	03331652570	FCC DoC Approved	Provided by Lab
H.	Wireless Broadband Router	BUFFALO	WHR-G300N-AP	74059085108007	FDI-09101528-0	Provided by Lab
I.	NB	DELL	PP18L	N/A	FCC DoC Approved	Supplied by client

Note:

1. All power cords of the above support units are non-shielded (1.8m).
2. Items H-I acted as communication partners to transfer data.

No.	Cable	Qty.	Length (m)	Shielded (Yes/ No)	Cores (Number)	Remark
1.	EPO cable	1	5.0	N	0	Supplied by client
2.	AC power cable	6	1.8	N	0	Provided by Lab
3.	AC power cable	2	2.2	N	0	Provided by Lab
4.	RJ45 to RS232 cable	1	5.0	N	0	Supplied by client
5.	USB cable	1	5.0	Y	0	Supplied by client
6.	LCE (LAN) cable	1	10	N	0	Supplied by client
7.	Universal I/O cable	2	5.0	N	0	Supplied by client
8.	LAN cable	1	10	N	0	Provided by Lab
9.	AC Power cord	1	2.0	N	0	Supplied by client
10.	USB cable	2	1.8	Y	0	Provided by Lab
11.	LAN cable	1	1.5	N	0	Provided by Lab
12.	USB cable	1	2.0	Y	0	Provided by Lab
13.	USB cable	1	1.8	Y	0	Provided by Lab
14.	USB cable	1	1.8	Y	1	Provided by Lab
15.	DC cable	1	1.8	N	0	Provided by Lab

Note: The core(s) is(are) originally attached to the cable(s).



A D T

5 Conducted Emissions at Mains Ports

5.1 Limits

Frequency (MHz)	Class A (dBUV)		Class B (dBUV)	
	Quasi-peak	Average	Quasi-peak	Average
0.15 - 0.5	79	66	66 - 56	56 - 46
0.50 - 5.0	73	60	56	46
5.0 - 30.0	73	60	60	50

Notes: 1. The lower limit shall apply at the transition frequencies.
2. The limit decreases linearly with the logarithm of the frequency in the range of 0.15 to 0.50 MHz.

5.2 Test Instruments

Description & Manufacturer	Model No.	Serial No.	Cal. Date	Cal. Due
ROHDE & SCHWARZ TEST RECEIVER	ESCS 30	100292	Dec. 18, 2014	Dec. 17, 2015
ROHDE & SCHWARZ Artificial Mains Network (for EUT)	ESH2-Z5	100104	Dec. 04, 2014	Dec. 03, 2015
LISN With Adapter (for EUT)	AD10	C09Ada-001	Dec. 04, 2014	Dec. 03, 2015
ROHDE & SCHWARZ Artificial Mains Network (for peripherals)	ESH3-Z5	847265/023	Oct. 21, 2014	Oct. 20, 2015
SCHWARZBECK Artificial Mains Network (For EUT)	NNLK8129	8129229	May 08, 2014	May 07, 2015
Software	ADT_Cond_V7.3.7	NA	NA	NA
RF cable (JYEBAO)	5D-FB	Cable-C09.01	Feb. 24, 2015	Feb. 23, 2016
SUHNER Terminator (For ROHDE & SCHWARZ LISN)	65BNC-5001	E1-010789	May 20, 2014	May 19, 2015
ROHDE & SCHWARZ Artificial Mains Network (For TV EUT)	ESH3-Z5	100220	Nov. 20, 2014	Nov. 19, 2015
LISN With Adapter (for TV EUT)	100220	N/A	Nov. 20, 2014	Nov. 19, 2015

Notes: 1. The calibration interval of the above test instruments is 12 months and the calibrations are traceable to NML/ROC and NIST/USA.
2. The test was performed in Shielded Room No. 9.
3. The VCCI Site Registration No. C-1312.
4. Tested Date: May 6, 2015.

5.3 Test Arrangement

- The EUT was placed 0.4 meters from the conducting wall of the shielded room with EUT being connected to the power mains through a line impedance stabilization network (LISN). Other support units were connected to the power mains through another LISN. The two LISNs provide 50 Ohm/ 50uH of coupling impedance for the measuring instrument.
- Both lines of the power mains connected to the EUT were checked for maximum conducted interference.
- The test results of conducted emissions at mains ports are recorded of six worst margins for quasi-peak (mandatory) [and average (if necessary)] values against the limits at frequencies of interest unless the margin is 20 dB or greater.

Note: The resolution bandwidth and video bandwidth of test receiver is 9kHz for quasi-peak detection (QP) and average detection (AV) at frequency 0.15MHz-30MHz.

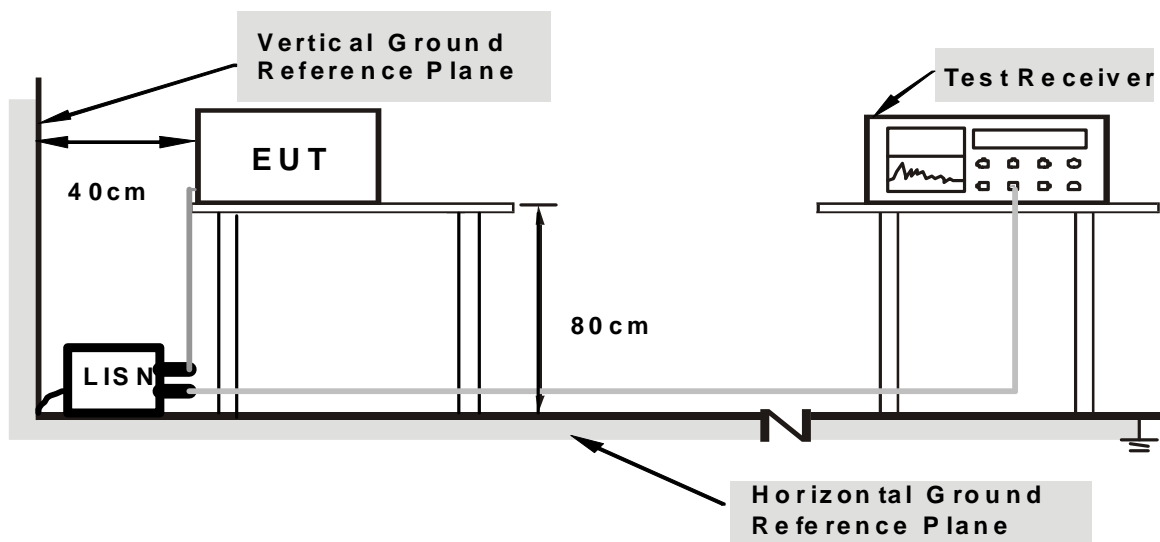

Note: Support units were connected to second LISN.

For the actual test configuration, please refer to the related item – Photographs of the Test Configuration.

5.4 Test Results (1)

Frequency Range	150kHz ~ 30MHz	Detector Function & Resolution Bandwidth	Quasi-Peak (QP) / Average (AV), 9kHz
Input Power	208Vac, 60Hz	Environmental Conditions	24°C, 66%RH
Tested by	Jary Huang		
Test Mode	Mode 1		

Phase Of Power : Line (L)										
No	Frequency (MHz)	Correction Factor (dB)	Reading Value (dBuV)		Emission Level (dBuV)		Limit (dBuV)		Margin (dB)	
			Q.P.	AV.	Q.P.	AV.	Q.P.	AV.	Q.P.	AV.
1	0.15129	0.21	63.15	59.05	63.36	59.26	79.00	66.00	-15.64	-6.74
2	0.18125	0.21	55.33	51.53	55.54	51.74	79.00	66.00	-23.46	-14.26
3	6.08594	0.63	41.36	35.57	41.99	36.20	73.00	60.00	-31.01	-23.80
4	8.92188	0.72	50.83	45.46	51.55	46.18	73.00	60.00	-21.45	-13.82
5	14.16144	0.93	53.47	51.08	54.40	52.01	73.00	60.00	-18.60	-7.99
6	23.12763	1.12	46.27	44.04	47.39	45.16	73.00	60.00	-25.61	-14.84

Remarks:

1. Q.P. and AV. are abbreviations of quasi-peak and average individually.
2. The emission levels of other frequencies were very low against the limit.
3. Margin value = Emission level – Limit value
4. Correction factor = Insertion loss + Cable loss
5. Emission Level = Correction Factor + Reading Value

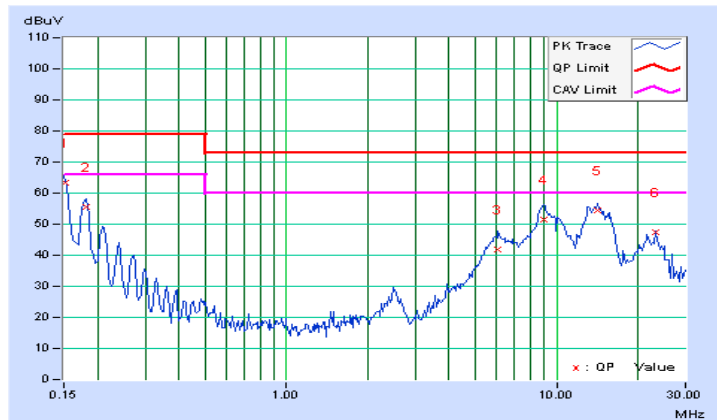

Frequency Range	150kHz ~ 30MHz	Detector Function & Resolution Bandwidth	Quasi-Peak (QP) / Average (AV), 9kHz
Input Power	208Vac, 60Hz	Environmental Conditions	24°C, 66%RH
Tested by	Jary Huang		
Test Mode	Mode 1		

Phase Of Power : Neutral (N)										
No	Frequency (MHz)	Correction Factor (dB)	Reading Value (dBuV)		Emission Level (dBuV)		Limit (dBuV)		Margin (dB)	
			Q.P.	AV.	Q.P.	AV.	Q.P.	AV.	Q.P.	AV.
1	0.15000	0.21	51.04	47.23	51.25	47.44	79.00	66.00	-27.75	-18.56
2	0.18125	0.22	47.48	43.38	47.70	43.60	79.00	66.00	-31.30	-22.40
3	6.23828	0.63	42.17	36.13	42.80	36.76	73.00	60.00	-30.20	-23.24
4	9.03125	0.71	51.42	46.07	52.13	46.78	73.00	60.00	-20.87	-13.22
5	14.16016	0.84	54.13	51.99	54.97	52.83	73.00	60.00	-18.03	-7.17
6	23.12763	0.81	45.46	43.34	46.27	44.15	73.00	60.00	-26.73	-15.85

Remarks:

1. Q.P. and AV. are abbreviations of quasi-peak and average individually.
2. The emission levels of other frequencies were very low against the limit.
3. Margin value = Emission level – Limit value
4. Correction factor = Insertion loss + Cable loss
5. Emission Level = Correction Factor + Reading Value

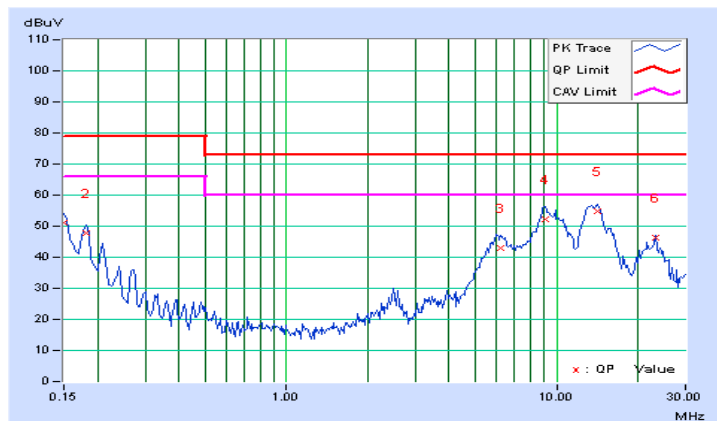

5.5 Test Results (2)

Frequency Range	150kHz ~ 30MHz	Detector Function & Resolution Bandwidth	Quasi-Peak (QP) / Average (AV), 9kHz
Input Power	208Vac, 60Hz	Environmental Conditions	24°C, 66%RH
Tested by	Jary Huang		
Test Mode	Mode 2		

Phase Of Power : Line (L)										
No	Frequency (MHz)	Correction Factor (dB)	Reading Value (dBuV)		Emission Level (dBuV)		Limit (dBuV)		Margin (dB)	
			Q.P.	AV.	Q.P.	AV.	Q.P.	AV.	Q.P.	AV.
1	0.15000	0.21	62.57	58.29	62.78	58.50	79.00	66.00	-16.22	-7.50
2	0.18125	0.21	56.07	51.49	56.28	51.70	79.00	66.00	-22.72	-14.30
3	6.23828	0.63	39.08	32.33	39.71	32.96	73.00	60.00	-33.29	-27.04
4	8.91016	0.72	45.21	39.37	45.93	40.09	73.00	60.00	-27.07	-19.91
5	14.13281	0.93	50.99	46.65	51.92	47.58	73.00	60.00	-21.08	-12.42
6	23.12891	1.12	45.71	42.97	46.83	44.09	73.00	60.00	-26.17	-15.91

Remarks:

1. Q.P. and AV. are abbreviations of quasi-peak and average individually.
2. The emission levels of other frequencies were very low against the limit.
3. Margin value = Emission level – Limit value
4. Correction factor = Insertion loss + Cable loss
5. Emission Level = Correction Factor + Reading Value

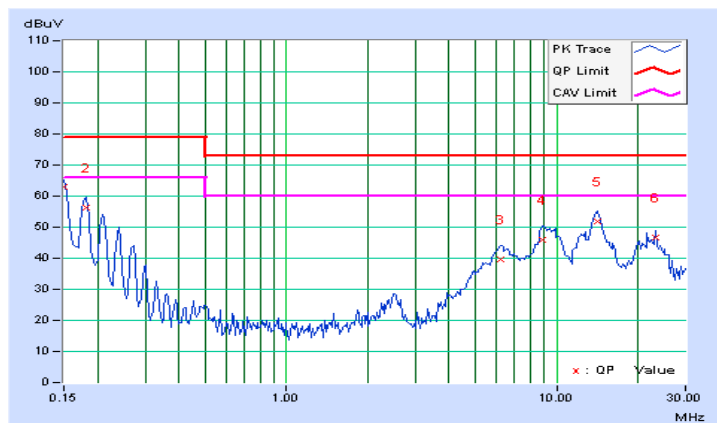

Frequency Range	150kHz ~ 30MHz	Detector Function & Resolution Bandwidth	Quasi-Peak (QP) / Average (AV), 9kHz
Input Power	208Vac, 60Hz	Environmental Conditions	24°C, 66%RH
Tested by	Jary Huang		
Test Mode	Mode 2		

Phase Of Power : Neutral (N)										
No	Frequency (MHz)	Correction Factor (dB)	Reading Value (dBuV)		Emission Level (dBuV)		Limit (dBuV)		Margin (dB)	
			Q.P.	AV.	Q.P.	AV.	Q.P.	AV.	Q.P.	AV.
1	0.15000	0.21	50.98	46.34	51.19	46.55	79.00	66.00	-27.81	-19.45
2	0.18125	0.22	48.23	43.82	48.45	44.04	79.00	66.00	-30.55	-21.96
3	5.94141	0.63	41.00	34.06	41.63	34.69	73.00	60.00	-31.37	-25.31
4	9.12109	0.72	52.52	46.99	53.24	47.71	73.00	60.00	-19.76	-12.29
5	13.98047	0.83	51.97	47.75	52.80	48.58	73.00	60.00	-20.20	-11.42
6	23.12763	0.81	45.40	43.03	46.21	43.84	73.00	60.00	-26.79	-16.16

Remarks:

1. Q.P. and AV. are abbreviations of quasi-peak and average individually.
2. The emission levels of other frequencies were very low against the limit.
3. Margin value = Emission level – Limit value
4. Correction factor = Insertion loss + Cable loss
5. Emission Level = Correction Factor + Reading Value

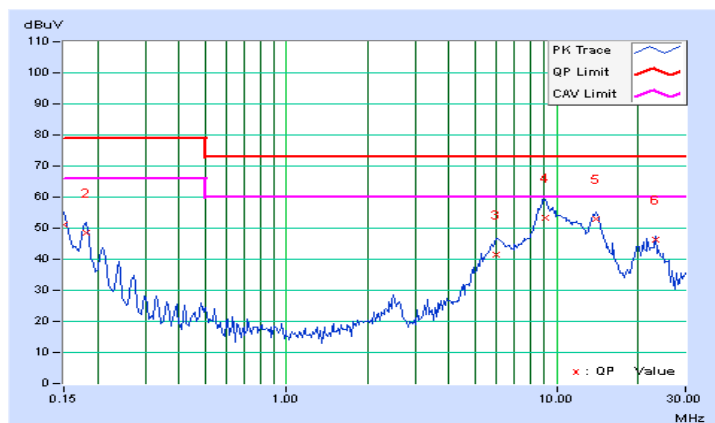

5.6 Test Results (3)

Frequency Range	150kHz ~ 30MHz	Detector Function & Resolution Bandwidth	Quasi-Peak (QP) / Average (AV), 9kHz
Input Power	208Vac, 60Hz	Environmental Conditions	24°C, 66%RH
Tested by	Jary Huang		
Test Mode	Mode 3		

Phase Of Power : Line (L)										
No	Frequency (MHz)	Correction Factor (dB)	Reading Value (dBuV)		Emission Level (dBuV)		Limit (dBuV)		Margin (dB)	
			Q.P.	AV.	Q.P.	AV.	Q.P.	AV.	Q.P.	AV.
1	0.16036	0.21	39.69	36.86	39.90	37.07	79.00	66.00	-39.10	-28.93
2	1.12109	0.38	34.27	32.85	34.65	33.23	73.00	60.00	-38.35	-26.77
3	2.40099	0.48	49.69	48.69	50.17	49.17	73.00	60.00	-22.83	-10.83
4	8.76953	0.72	43.21	38.22	43.93	38.94	73.00	60.00	-29.07	-21.06
5	13.91797	0.92	44.33	36.74	45.25	37.66	73.00	60.00	-27.75	-22.34
6	19.76172	1.13	43.09	35.36	44.22	36.49	73.00	60.00	-28.78	-23.51

Remarks:

1. Q.P. and AV. are abbreviations of quasi-peak and average individually.
2. The emission levels of other frequencies were very low against the limit.
3. Margin value = Emission level – Limit value
4. Correction factor = Insertion loss + Cable loss
5. Emission Level = Correction Factor + Reading Value

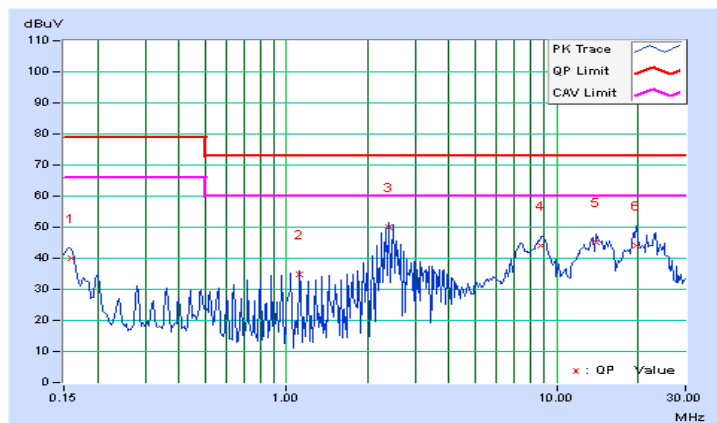

Frequency Range	150kHz ~ 30MHz	Detector Function & Resolution Bandwidth	Quasi-Peak (QP) / Average (AV), 9kHz
Input Power	208Vac, 60Hz	Environmental Conditions	24°C, 66%RH
Tested by	Jary Huang		
Test Mode	Mode 3		

Phase Of Power : Neutral (N)										
No	Frequency (MHz)	Correction Factor (dB)	Reading Value (dBuV)		Emission Level (dBuV)		Limit (dBuV)		Margin (dB)	
			Q.P.	AV.	Q.P.	AV.	Q.P.	AV.	Q.P.	AV.
1	0.16161	0.21	33.77	30.74	33.98	30.95	79.00	66.00	-45.02	-35.05
2	1.28125	0.41	32.54	30.96	32.95	31.37	73.00	60.00	-40.05	-28.63
3	2.32048	0.49	48.70	48.02	49.19	48.51	73.00	60.00	-23.81	-11.49
4	7.28125	0.66	42.33	35.61	42.99	36.27	73.00	60.00	-30.01	-23.73
5	14.40234	0.84	41.07	34.89	41.91	35.73	73.00	60.00	-31.09	-24.27
6	20.16016	0.94	40.50	31.32	41.44	32.26	73.00	60.00	-31.56	-27.74

Remarks:

1. Q.P. and AV. are abbreviations of quasi-peak and average individually.
2. The emission levels of other frequencies were very low against the limit.
3. Margin value = Emission level – Limit value
4. Correction factor = Insertion loss + Cable loss
5. Emission Level = Correction Factor + Reading Value

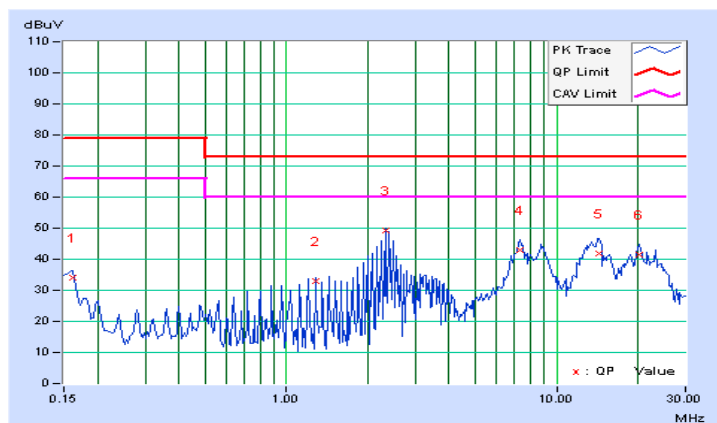

6 Radiated Emissions up to 1 GHz

6.1 Limits

Emissions radiated outside of the specified bands, shall be according to the general radiated limits as following:

Radiated Emissions Limits at 10 meters (dB μ V/m)				
Frequencies (MHz)	FCC 15B / ICES-003, Class A	FCC 15B / ICES-003, Class B	CISPR 22, Class A	CISPR 22, Class B
30-88	39	29.5	40	30
88-216	43.5	33.1		
216-230	46.4	35.6	47	37
230-960				
960-1000	49.5	43.5		

Radiated Emissions Limits at 3 meters (dB μ V/m)				
Frequencies (MHz)	FCC 15B / ICES-003, Class A	FCC 15B / ICES-003, Class B	CISPR 22, Class A	CISPR 22, Class B
30-88	49.5	40	50.5	40.5
88-216	54	43.5		
216-230	56.9	46	57.5	47.5
230-960				
960-1000	60	54		

- Notes:
1. The lower limit shall apply at the transition frequencies.
 2. Emission level (dB μ V/m) = 20 log Emission level (μ V/m).
 3. QP detector shall be applied if not specified.



6.2 Test Instruments

Description & Manufacturer	Model No.	Serial No.	Cal. Date	Cal. Due
Agilent Preamplifier	8447D	2944A11062	Feb. 27, 2015	Feb. 26, 2016
Agilent Preamplifier	8447D	2944A11064	Feb. 27, 2015	Feb. 26, 2016
Agilent Test Receiver	N9038A	MY50010158	Jul. 22, 2014	Jul. 21, 2015
Agilent Test Receiver	N9038A	MY51210114	Dec. 09, 2014	Dec. 08, 2015
Schwarzbeck Antenna	VULB9168	9168-316	Feb. 06, 2015	Feb. 05, 2016
Schwarzbeck Antenna	VULB9168	9168-317	Feb. 06, 2015	Feb. 05, 2016
Max Full. Turn Table & Tower	MF7802	MF7802121	NA	NA
Max Full. Tower	MF7802	MF780208105	NA	NA
Software	ADT_Radiated_V8.7.07	NA	NA	NA
WOKEN RF cable	8D	CABLE-CH8-01.V	Dec. 17, 2014	Dec. 16, 2015
JYE BAO RF cable	8D	CABLE-CH8-02.H	Dec. 17, 2014	Dec. 16, 2015
JYE BAO RF cable	8D	CABLE-CH8-03.3M	Dec. 17, 2014	Dec. 16, 2015

Notes: 1. The calibration interval of the above test instruments is 12 months and the calibrations are traceable to NML/ROC and NIST/USA.

2. The test was performed in Chamber No. 8.
3. The Industry Canada Reference No. IC 7450E-8.
4. The VCCI Site Registration No. R-2946.
5. The FCC Site Registration No. 493821.
6. Tested Date: Apr. 30, 2015.

6.3 Test Arrangement

- The EUT was placed on the top of a rotating table 0.8 meters above the ground at an accredited test facility. The table was rotated 360 degrees to determine the position of the highest radiation.
- The EUT was set 10 meters away from the interference-receiving antenna, which was mounted on the top of a variable-height antenna tower.
- The antenna is a broadband antenna, and its height is varied from one meter to four meters above the ground to determine the maximum value of the field strength. Both horizontal and vertical polarizations of the antenna are set to make the measurement.
- For each suspected emission, the EUT was arranged to its worst case and then the antenna was tuned to heights from 1 meter to 4 meters and the rotatable table was turned from 0 degrees to 360 degrees to find the maximum reading.
- The test-receiver system was set to quasi-peak detect function and specified bandwidth with maximum hold mode when the test frequency is below 1 GHz.

Note: The resolution bandwidth and video bandwidth of test receiver/spectrum analyzer is 120kHz for quasi-peak detection (QP) at frequency below 1GHz.

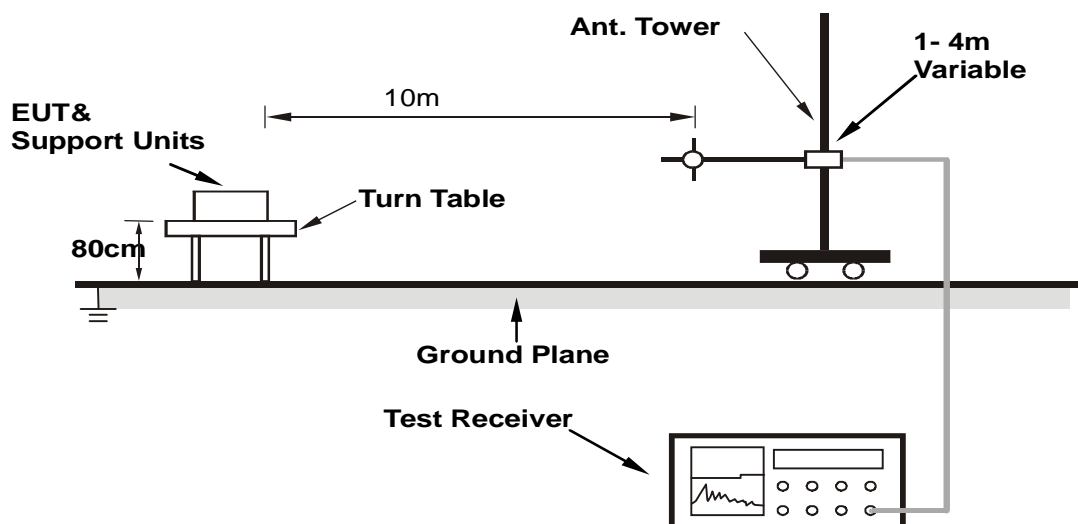

For the actual test configuration, please refer to the related item – Photographs of the Test Configuration.

6.4 Test Results (1)

Frequency Range	30MHz ~ 1GHz	Detector Function & Resolution Bandwidth	Quasi-Peak (QP), 120kHz
Input Power	208Vac, 60Hz	Environmental Conditions	24°C, 66%RH
Tested by	Jary Huang		
Test Mode	Mode 1		

Antenna Polarity & Test Distance : Horizontal at 10 m

No	Frequency (MHz)	Emission Level (dBuV/m)	Limit (dBuV/m)	Margin (dB)	Antenna Height (m)	Table Angle (Degree)	Raw Value (dBuV)	Correction Factor (dB/m)
1	111.92	33.81 QP	43.50	-9.69	3.34 H	346	48.79	-14.98
2	203.58	32.36 QP	43.50	-11.14	2.63 H	230	46.76	-14.40
3	300.00	40.09 QP	46.40	-6.31	3.16 H	172	49.82	-9.73
4	400.01	40.24 QP	46.40	-6.16	2.26 H	130	47.65	-7.41
5	450.01	36.61 QP	46.40	-9.79	2.41 H	353	42.58	-5.97
6	825.01	34.78 QP	46.40	-11.62	1.85 H	302	33.64	1.14
7	927.49	35.10 QP	46.40	-11.30	1.00 H	202	32.05	3.05

Remarks:

1. Emission Level(dBuV/m) = Raw Value(dBuV) + Correction Factor(dB/m)
2. Correction Factor(dB/m) = Antenna Factor (dB/m) + Cable Factor (dB) – Pre-Amplifier Factor (dB)
3. The other emission levels were very low against the limit.
4. Margin value = Emission level – Limit value

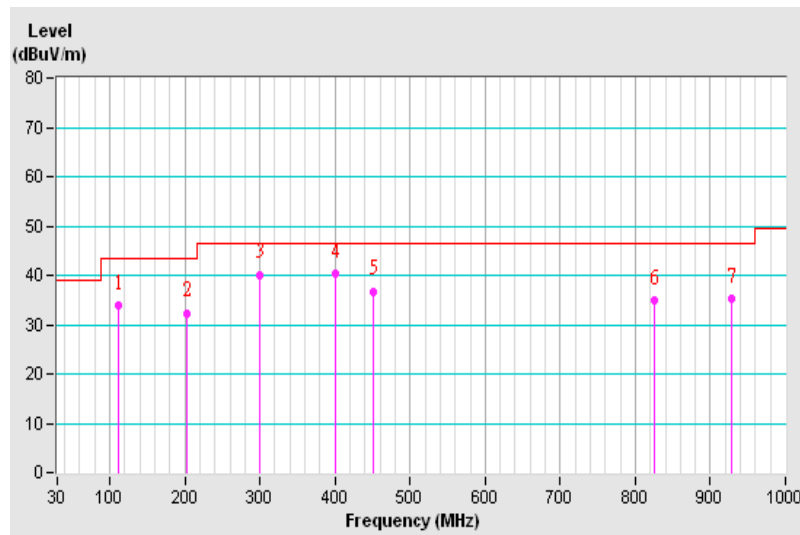



Frequency Range	30MHz ~ 1GHz	Detector Function & Resolution Bandwidth	Quasi-Peak (QP), 120kHz
Input Power	208Vac, 60Hz	Environmental Conditions	24°C, 66%RH
Tested by	Jary Huang		
Test Mode	Mode 1		

Antenna Polarity & Test Distance : Vertical at 10 m								
No	Frequency (MHz)	Emission Level (dBuV/m)	Limit (dBuV/m)	Margin (dB)	Antenna Height (m)	Table Angle (Degree)	Raw Value (dBuV)	Correction Factor (dB/m)
1	41.38	33.45 QP	39.00	-5.55	1.03 V	185	46.40	-12.95
2	82.14	33.76 QP	39.00	-5.24	1.00 V	330	50.67	-16.91
3	117.91	30.31 QP	43.50	-13.19	1.23 V	121	44.37	-14.06
4	300.00	38.31 QP	46.40	-8.09	2.41 V	302	47.74	-9.43
5	400.01	39.74 QP	46.40	-6.66	2.96 V	351	47.10	-7.36
6	662.54	38.76 QP	46.40	-7.64	3.42 V	312	40.84	-2.08
7	825.01	35.96 QP	46.40	-10.44	2.93 V	138	35.02	0.94

Remarks:

1. Emission Level(dBuV/m) = Raw Value(dBuV) + Correction Factor(dB/m)
2. Correction Factor(dB/m) = Antenna Factor (dB/m) + Cable Factor (dB) – Pre-Amplifier Factor (dB)
3. The other emission levels were very low against the limit.
4. Margin value = Emission level – Limit value

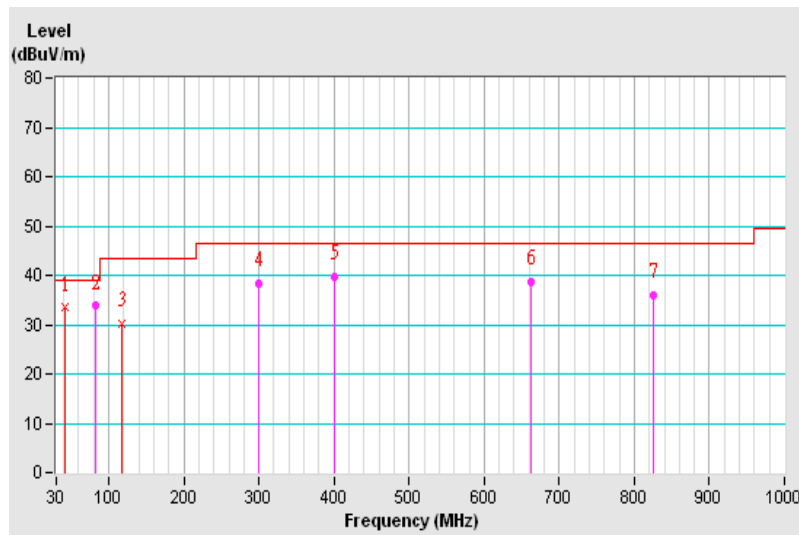

6.5 Test Results (2)

Frequency Range	30MHz ~ 1GHz	Detector Function & Resolution Bandwidth	Quasi-Peak (QP), 120kHz
Input Power	208Vac, 60Hz	Environmental Conditions	24°C, 66%RH
Tested by	Jary Huang		
Test Mode	Mode 2		

Antenna Polarity & Test Distance : Horizontal at 10 m

No	Frequency (MHz)	Emission Level (dBuV/m)	Limit (dBuV/m)	Margin (dB)	Antenna Height (m)	Table Angle (Degree)	Raw Value (dBuV)	Correction Factor (dB/m)
1	149.94	30.75 QP	43.50	-12.75	3.64 H	73	42.72	-11.97
2	265.03	34.98 QP	46.40	-11.42	1.68 H	266	46.28	-11.30
3	300.00	40.37 QP	46.40	-6.03	2.43 H	175	50.10	-9.73
4	400.01	40.82 QP	46.40	-5.58	1.60 H	134	48.23	-7.41
5	500.01	33.16 QP	46.40	-13.24	2.76 H	0	38.52	-5.36
6	825.01	34.31 QP	46.40	-12.09	1.21 H	304	33.17	1.14
7	927.54	35.52 QP	46.40	-10.88	3.75 H	232	32.47	3.05

Remarks:

1. Emission Level(dBuV/m) = Raw Value(dBuV) + Correction Factor(dB/m)
2. Correction Factor(dB/m) = Antenna Factor (dB/m) + Cable Factor (dB) – Pre-Amplifier Factor (dB)
3. The other emission levels were very low against the limit.
4. Margin value = Emission level – Limit value

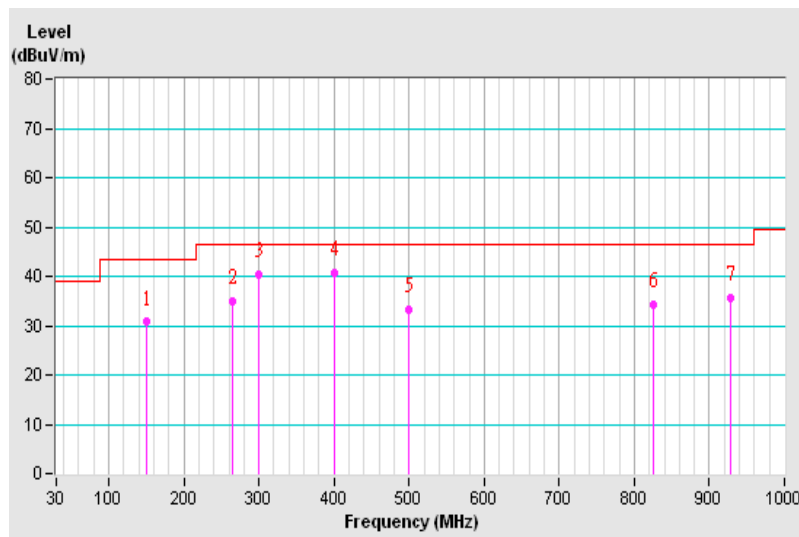

Frequency Range	30MHz ~ 1GHz	Detector Function & Resolution Bandwidth	Quasi-Peak (QP), 120kHz
Input Power	208Vac, 60Hz	Environmental Conditions	24°C, 66%RH
Tested by	Jary Huang		
Test Mode	Mode 2		

Antenna Polarity & Test Distance : Vertical at 10 m								
No	Frequency (MHz)	Emission Level (dBuV/m)	Limit (dBuV/m)	Margin (dB)	Antenna Height (m)	Table Angle (Degree)	Raw Value (dBuV)	Correction Factor (dB/m)
1	41.40	31.55 QP	39.00	-7.45	1.13 V	164	44.50	-12.95
2	122.64	33.62 QP	43.50	-9.88	1.68 V	104	47.40	-13.78
3	169.53	34.48 QP	43.50	-9.02	2.14 V	165	45.92	-11.44
4	300.00	39.41 QP	46.40	-6.99	3.21 V	5	48.84	-9.43
5	400.01	40.07 QP	46.40	-6.33	2.46 V	356	47.43	-7.36
6	662.54	39.54 QP	46.40	-6.86	3.72 V	299	41.62	-2.08
7	825.01	35.66 QP	46.40	-10.74	3.00 V	169	34.72	0.94

Remarks:

1. Emission Level(dBuV/m) = Raw Value(dBuV) + Correction Factor(dB/m)
2. Correction Factor(dB/m) = Antenna Factor (dB/m) + Cable Factor (dB) – Pre-Amplifier Factor (dB)
3. The other emission levels were very low against the limit.
4. Margin value = Emission level – Limit value

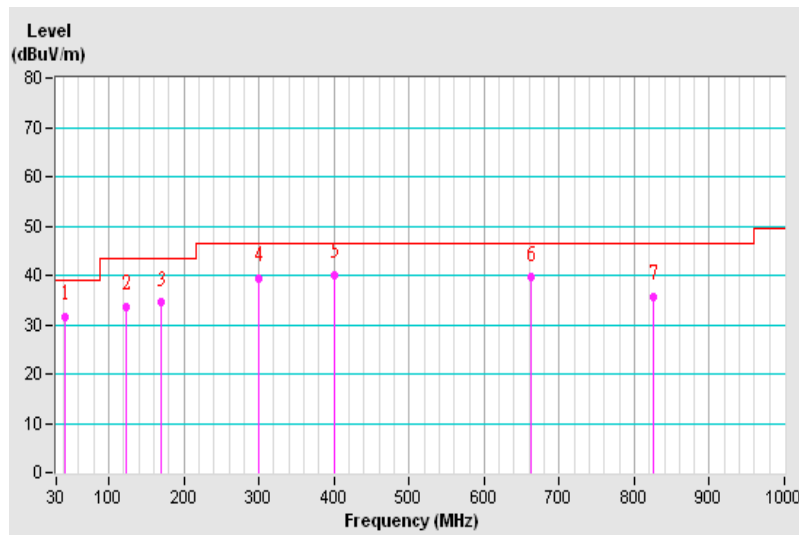

6.6 Test Results (3)

Frequency Range	30MHz ~ 1GHz	Detector Function & Resolution Bandwidth	Quasi-Peak (QP), 120kHz
Input Power	208Vac, 60Hz	Environmental Conditions	24°C, 66%RH
Tested by	Jary Huang		
Test Mode	Mode 3		

Antenna Polarity & Test Distance : Horizontal at 10 m								
No	Frequency (MHz)	Emission Level (dBuV/m)	Limit (dBuV/m)	Margin (dB)	Antenna Height (m)	Table Angle (Degree)	Raw Value (dBuV)	Correction Factor (dB/m)
1	91.16	31.55 QP	43.50	-11.95	3.82 H	74	49.53	-17.98
2	300.00	40.76 QP	46.40	-5.64	3.23 H	170	50.49	-9.73
3	400.01	39.82 QP	46.40	-6.58	2.75 H	133	47.23	-7.41
4	450.01	35.82 QP	46.40	-10.58	2.32 H	355	41.79	-5.97
5	600.02	32.34 QP	46.40	-14.06	1.67 H	90	35.12	-2.78
6	825.01	34.08 QP	46.40	-12.32	1.29 H	300	32.94	1.14
7	927.54	35.36 QP	46.40	-11.04	2.53 H	271	32.31	3.05

Remarks:

1. Emission Level(dBuV/m) = Raw Value(dBuV) + Correction Factor(dB/m)
2. Correction Factor(dB/m) = Antenna Factor (dB/m) + Cable Factor (dB) – Pre-Amplifier Factor (dB)
3. The other emission levels were very low against the limit.
4. Margin value = Emission level – Limit value

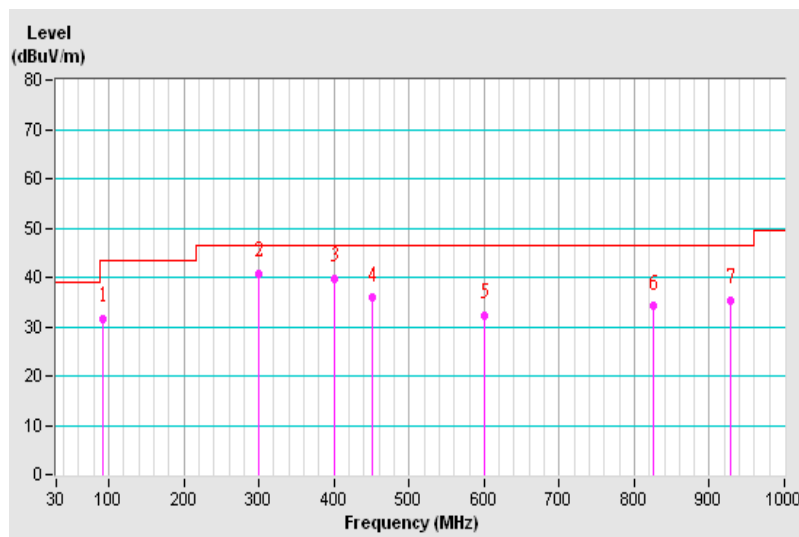

Frequency Range	30MHz ~ 1GHz	Detector Function & Resolution Bandwidth	Quasi-Peak (QP), 120kHz
Input Power	208Vac, 60Hz	Environmental Conditions	24°C, 66%RH
Tested by	Jary Huang		
Test Mode	Mode 3		

Antenna Polarity & Test Distance : Vertical at 10 m								
No	Frequency (MHz)	Emission Level (dBuV/m)	Limit (dBuV/m)	Margin (dB)	Antenna Height (m)	Table Angle (Degree)	Raw Value (dBuV)	Correction Factor (dB/m)
1	41.35	31.17 QP	39.00	-7.83	1.03 V	164	44.12	-12.95
2	123.94	33.78 QP	43.50	-9.72	1.62 V	101	47.39	-13.61
3	300.00	38.98 QP	46.40	-7.42	2.71 V	310	48.41	-9.43
4	400.01	39.98 QP	46.40	-6.42	2.52 V	2	47.34	-7.36
5	662.54	39.58 QP	46.40	-6.82	3.84 V	302	41.66	-2.08
6	825.01	36.48 QP	46.40	-9.92	3.13 V	138	35.54	0.94

Remarks:

1. Emission Level(dBuV/m) = Raw Value(dBuV) + Correction Factor(dB/m)
2. Correction Factor(dB/m) = Antenna Factor (dB/m) + Cable Factor (dB) – Pre-Amplifier Factor (dB)
3. The other emission levels were very low against the limit.
4. Margin value = Emission level – Limit value

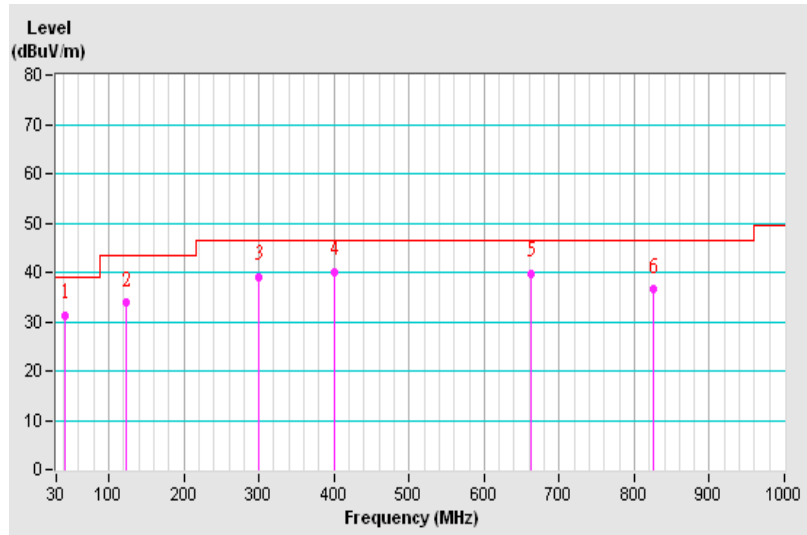

7 Pictures of Test Arrangements

7.1 Conducted Emissions at Mains Ports



7.2 Radiated Emissions up to 1 GHz





A D T

Appendix – Information on the Testing Laboratories

We, Bureau Veritas Consumer Products Services (H.K.) Ltd., Taoyuan Branch, were founded in 1988 to provide our best service in EMC, Radio, Telecom and Safety consultation. Our laboratories are accredited and approved according to ISO/IEC 17025.

If you have any comments, please feel free to contact us at the following:

Linko EMC/RF Lab

Tel: 886-2-26052180

Fax: 886-2-26051924

Hsin Chu EMC/RF/Telecom Lab

Tel: 886-3-5935343

Fax: 886-3-5935342

Hwa Ya EMC/RF/Safety Lab

Tel: 886-3-3183232

Fax: 886-3-3270892

Email: service.adt@tw.bureauveritas.com

Web Site: www.bureauveritas-adt.com

The address and road map of all our labs can be found in our web site also.

--- END ---