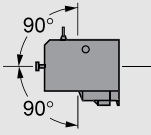
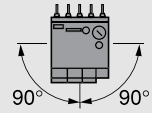

Environment									
Conforming to standards			IEC 60947, NF C 63-650, VDE 0660, BS 4941						
Product certifications			UL, CSA						
Protective treatment	Conforming to IEC 60068 (DIN 50016)		"TC" (Klimafest, Climateproof)						
Degree of protection	Conforming to VDE 0106		Protection against direct finger contact						
Ambient air temperature around the device	Storage	°C	- 40...+ 70						
	For normal operation (IEC 60947)	°C	- 20...+ 55 (without derating)						
	Operating limit	°C	- 30...+ 60 (with derating) (1)						
Maximum operating altitude	Without derating	m	2000						
Operating positions			Vertical axis  Without derating	Horizontal axis  With derating (1)					
Flame resistance	Conforming to UL 94		Self-extinguishing material V1						
	Conforming to NF F 16-101 and 16-102		Conforming to requirement 2						
Shock resistance, hot state (1/2 sine wave, 11 ms)	Conforming to IEC 60068, N/C contact		10 gn						
	Conforming to IEC 60068, N/O contact		10 gn						
Vibration resistance, hot state 5 to 300 Hz	Conforming to IEC 60068, N/C contact		2 gn						
	Conforming to IEC 60068, N/O contact		2 gn						
Safe separation of circuits	Conforming to VDE 0106 and IEC 60536		VLSV (2), up to 400 V						
Cabling Screw clamp terminals			Minimum	Maximum	Maximum to IEC 60947				
		Solid cable	mm ²	1 x 1.5	2 x 4	1 x 4 + 1 x 2.5			
		Flexible cable without cable end	mm ²	1 x 0.75	2 x 4	2 x 2.5			
		Flexible cable with cable end	mm ²	1 x 0.34	1 x 1.5 + 1 x 2.5	1 x 1.5 + 1 x 2.5			
Tightening torque	Phillips head n° 2 - Ø 6	N.m	0.8						
Mounting			Directly under the contactor or reversing contactor						
Connections			Made automatically when mounted under the contactor, as follows : <ul style="list-style-type: none"> ■ contactor terminal A2 connected to overload relay terminal 96 on all products, ■ contactor terminal 14 connected to overload relay terminal 95 on products with 3 P + N/O. When using 3 P + N/C, or 4 P contactors, or the N/O auxiliary contact marked 13-14, at a voltage other than the coil voltage, break off the link marked 14.						
Auxiliary contact characteristics									
Number of contacts			1 N/C + 1 N/O						
Conventional thermal current		A	6						
Short-circuit protection	Conforming to IEC 60947, VDE 0660. gG fuse or circuit-breaker GB2 CB●●	A	6 max.						
Maximum power of the controlled contactor coils (sealed) (Occasional operating cycles of contact 95-96)	a.c.	V	24	48	110	220/230	400	415/440	600/690
		VA	100	200	400	600	600	600	600
	d.c.	V	24	48	110	220	250	–	–
		W	100	100	50	45	35	–	–
Maximum operational voltage	a.c., category AC-15	V	690						
	d.c., category DC-13	V	250						

(1) Please consult your Regional Sales Office.

(2) Very low safety voltage.

Electrical characteristics of the power circuit

Rated operational voltage (Ue)	Up to	V	690
Rated insulation voltage (Ui)	Conforming to BS 4941	V	690
	Conforming to IEC 60947	V	690
	Conforming to VDE 0110 group C	V	750
	Conforming to CSA C 22-2 n° 14	V	600
Rated impulse withstand voltage (Uimp)		kV	6
Frequency limits of the operational current		Hz	Up to 400
Power dissipated per pole		W	2

Operating characteristics

Sensitivity to phase failure	Conforming to IEC 60947		Yes
Reset	Manual or automatic		Selected by means of a lockable and sealable switch on the front of the relay
Signalling	On front of relay		Trip indicator
Reset-Stop function			Pressing the Reset-Stop button : - actuates the N/C contact - has no effect on the N/O contact
Test function	By pushbutton		Pressing the Test button enables : - checking of the control circuit wiring - simulation of overload tripping (actuation of both N/C and N/O contacts, and of the trip indicator)
Short-circuit protection and coordination			See pages 24540/2 and 24543/2

Tripping curves

Average operating time related to multiples of the current setting (Class 10 A)

Balanced 3-phase operation, from cold state

Balanced operation with 2 phases only, from cold state

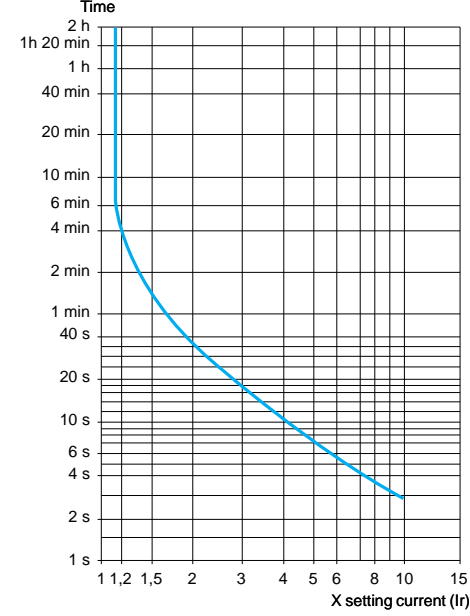
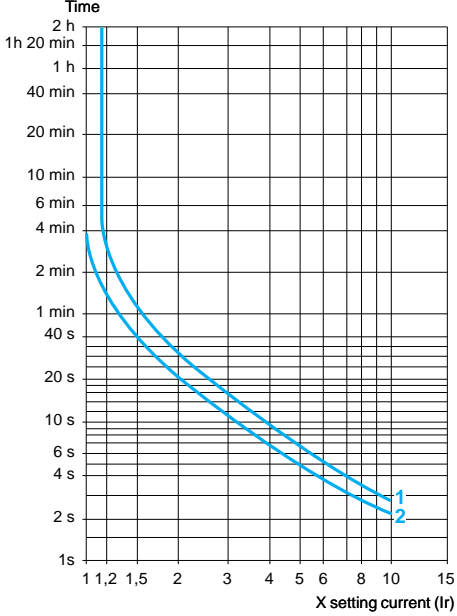

- 1 Setting : at lower end of scale
- 2 Setting : at upper end of scale

Protection components

TeSys K thermal overload relays, adjustable from 0.11 to 16 A

3-pole relays with screw clamp terminals

These overload relays are designed for the protection of motors. They are compensated and phase failure sensitive. Resetting can either be manual or automatic.

Direct mounting: under the contactor for versions with screw clamp terminals only; pre-wired terminals, see pages 22008/2 and 22009/3.

Separate mounting: using terminal block LA7 K0064 (see below).

On the front face of the overload relay:

- selection of reset mode: Manual (marked H) or Automatic (marked A),
- red pushbutton: Trip Test function,
- blue pushbutton: Stop and manual Reset,
- yellow trip flag indicator: overload relay tripped.

Protection by magnetic circuit-breaker GV2 LE, see pages 24540/2 and 24543/ 2.

106167_1



LR2 K0307

812569

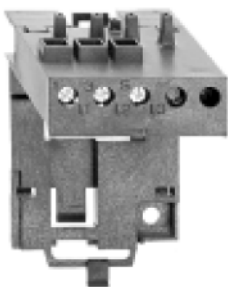

LA7 K0064

Class 10 A (the standard specifies a tripping time of between 2 and 10 seconds at 7.2 In)

Relay setting range	Fuses to be used with selected relay			Reference	Weight kg
	Maximum rating Type				
	aM	gG	BS88		
A	A	A	A		
0.11...0.16	0.25	0.5	–	LR2 K0301	0.145
0.16...0.23	0.25	0.5	–	LR2 K0302	0.145
0.23...0.36	0.5	1	–	LR2 K0303	0.145
0.36...0.54	1	1.6	–	LR2 K0304	0.145
0.54...0.8	1	2	–	LR2 K0305	0.145
0.8...1.2	2	4	6	LR2 K0306	0.145
1.2...1.8	2	6	6	LR2 K0307	0.145
1.8...2.6	4	8	10	LR2 K0308	0.145
2.6...3.7	4	10	16	LR2 K0310	0.145
3.7...5.5	6	16	16	LR2 K0312	0.145
5.5...8	8	20	20	LR2 K0314	0.145
8...11.5	10	25	20	LR2 K0316	0.145
10...14	16	32	25	LR2 K0321	0.145
12...16	20	40	32	LR2 K0322	0.145

Overload relays for unbalanced loads

Class 10 A: To order, replace the prefix LR2 by LR7 in the references selected from above (only applicable to overload relays LR2 K0305 to LR2 K0322).

Example: LR7 K0308.

Accessory

Description	Type of connection	Reference	Weight kg
Terminal block for separate clip-on mounting of the overload relay on 35 mm rail	Screw clamp	LA7 K0064	0.100

Dimensions, mounting

LR2 K

Direct mounting beneath the contactor

Separate mounting with terminal block LA7 K0064 on 35 mm rail
(AM1 DP200 or AM1 DE200)

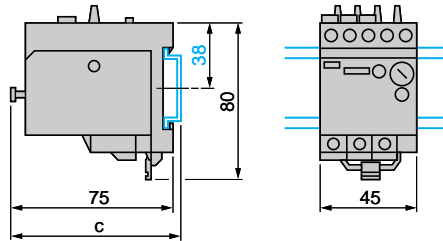
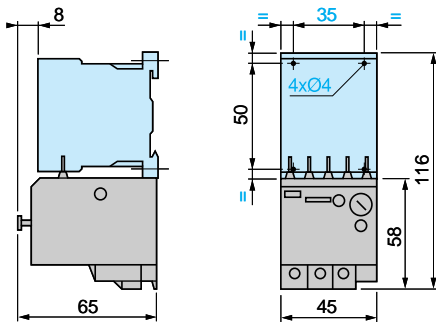

AM1	c
DP200	78.5
DE200	86

Schemes

LR2 K

LR2 K + LC• K

Pre-wiring scheme

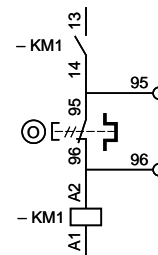
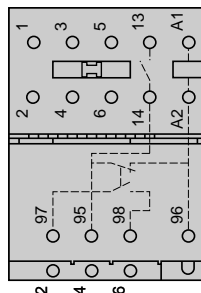
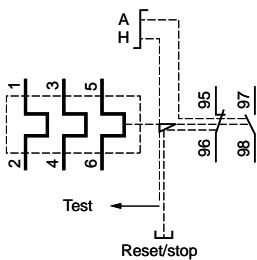

LR7 K

Note : If pre-wiring is not required, break off the 2 links located on the thermal overload relay.

