

Easergy VPIS V3

Easergy Range

Voltage Presence Indicating System
for Medium Voltage cubicles



Product at a glance

- Voltage presence indicating system in compliance with the IEC 62271-206 standard (and with the old IEC 61958 standard)
- 9 references available to adapt to all applications
- Voltage output option to provide Voltage signal to T300 SC150 module through an adapter.

VPIS V2 and VPIS V3

- Use VPIS V3 for applications with T300
- Use VPIS V2 with Flair 2xD or VD23
- If VPIS VO is not used, VPIS V2 or VPIS V3 can be used indifferently
- Never mix VPIS V2 and VPIS V3 in the same switchboard
- Phase concordance is not possible between VPIS V2 and VPIS V3.

The VPIS V3 is a self-powered voltage presence indicating system, in compliance with the IEC 62271-206 standard.

It includes:

- Voltage presence indication by LEDs: High reliability, very long life time.
- Connectors on the front panel allowing the use of a Phase Concordance Unit.
- On Voltage Output versions, four wires allowing to provide Voltage sensing to T300 SC150 module through an adapter.

It consists of two parts:

- **Surge protection part** (always connected). There are 2 models of this part: The standard one and the “VO” (Voltage Output) one, used to feed T300 SC150 module (through Voltage adapter - reference EMS59577). This part is the same for VPIS V2 and VPIS V3.
- **Voltage presence indication part** (replaceable for maintenance). There are 9 variants for this part, according to cubicle and Network Voltage. The 9 VPIS V3 indication parts are different from VPIS V2 ones, but each covers the same application range as its equivalent VPIS V2 one.

Retrofit of a VPIS V1 or VPIS V2 to VPIS V3 is easy: see VPIS Installation and Maintenance manual (reference NT00395-EN) for more details.

Easergy VPIS V3

Product Description



Phase Concordance Unit: Reference VPI62421

The 3 plugs on the front panel of VPIS V3 are designed for connection of Phase Concordance unit VPI62421. Never inject any current or voltage signal in these plugs.

VPIS V3 is designed to indicate the voltage presence according to IEC 62271-206. It does not provide any guarantee of voltage absence.

Phase concordance unit

Phase concordance can be carried out between 2 VPIS V3 using Phase Concordance unit reference VPI62421. This is the same Phase Concordance Unit as for VPIS V2.

It is not possible to carry out Phase Concordance between a VPIS V2 and a VPIS V3. See VPI62421 User Manual (reference NT00214-FR-EN) for more details. VPIS V3 is not designed to be used with other Phase Concordance Unit than VPI62421.

Threshold

In compliance with the IEC 62271-206 standard, the 3 VPIS V3 indication LEDs are lit or flashing when the network voltage or the relevant phase is > 45% of the rated voltage.

	IEC 62271-206: percentage of network voltage U	Equivalent percentage of rated voltage V	Status of VPIS indicator LEDs
	Phase-to-phase	Phase-to-ground (earth)	
Voltage value	10%	17%	Extinguished
	45%	78%	Lit or flashing

The flashing frequency increases with the network voltage value. At rated voltage, the indicator LEDs seem to be lit steadily.

Characteristics

Electromagnetic compatibility		Standards	Criteria	Test levels
Radiated interference	Emitted radiation	IEC 62271-1 § 6.9.1.2		30 MHz-1 GHz
Immunity test	Immunity to electrostatic discharge	IEC 61000-4-2 IEC 62271-1 § 6.9.2.1	B	± 6 kV contact discharge ± 8 kV discharge in air
	Radiated, radio-frequency, electromagnetic field immunity	IEC 61000-4-3 IEC 62271-1 § 6.9.2.1	A	10 V/m 80% AM at 1 kHz 80 MHz to 3 GHz
	Immunity to electrical fast transients	IEC 61000-4-4 IEC 62271-1 § 6.9.2.3	B	± 2 kV: mains power supply
	Slow damped oscillatory wave immunity	IEC 61000-4-18 IEC 62271-1 § 6.9.2.4	B	± 1 kV in differential mode ± 2.5 kV in common mode
	Radiated magnetic field immunity	IEC 61000-4-8 IEC 62271-1 § 6.9.2.1	B	Permanent magnetic field at 100 A/m, 1000 A/m during 1 s
Climatic tests		Standards		Test levels
Operating temperature		IEC 60068-2-14		-25°C to +85°C
Storage temperature				-40°C to +85°C
Ageing test		Not in compliance with a standard		Climatic cycles including damped heat (+85°C with 95%RH) and rapid du coup, aprèstemperature variations from -40°C to +85°C Full test duration: 1000 hours
Mechanical tests		Standards		Test levels
Mechanical	Protection	IEC 60529		IP3X
Impacts	De-energized	IEC 61958-1 IEC 60068-2-75		IK5 - 2 Joules 3 impacts in the weakest places

Easergy VPIS V3

Mechanical Description



Dimensions

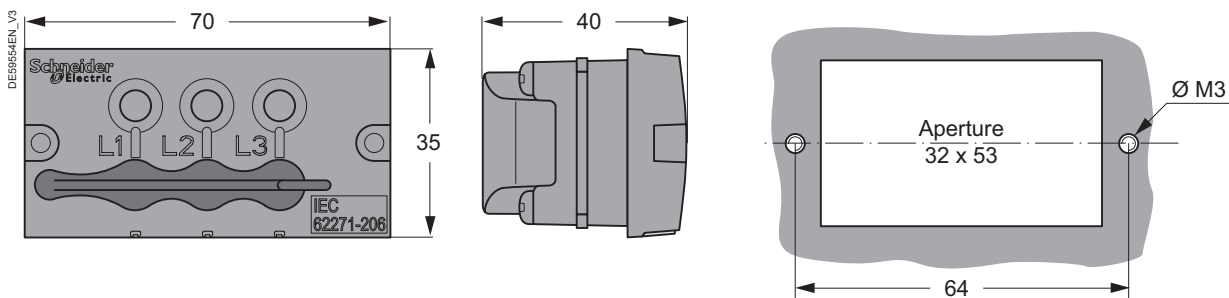

VPIS V3 Components

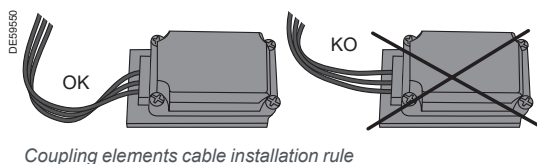
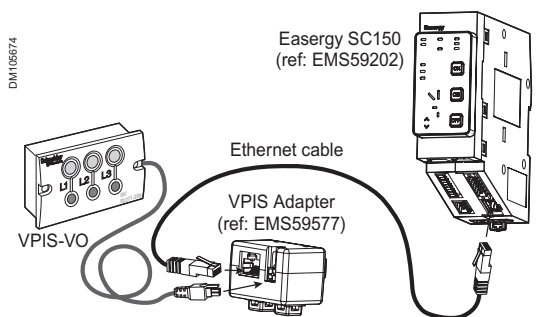
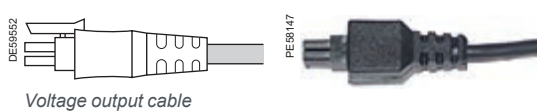
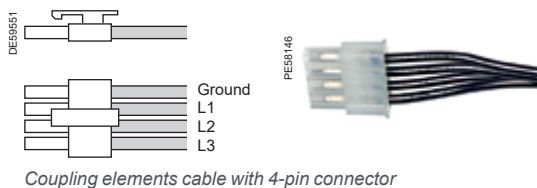
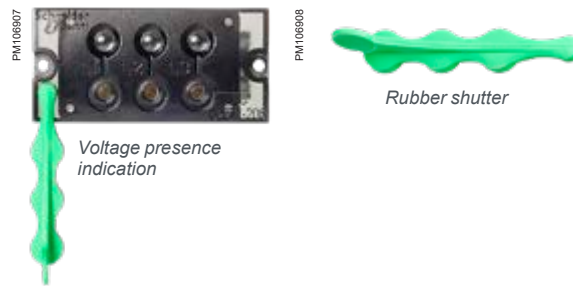
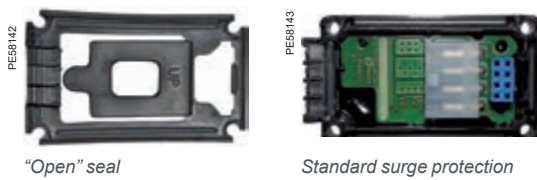

Connection

- The VPIS V3 includes a 4-pin connector for connection to the cubicle coupling elements: 1 pin for connection to ground (earth) and 1 pin for connection of the coupling elements on each phase:
 - The wires used have a cross-section of 1 mm², with an outside diameter ranging between 2.5 mm (0.098 in) and 2.9 mm (0.114 in)
 - The connector contacts are Minitip 5556 type
 - The connector housing is of MOLEX 39-01-4040 or 39-01-4041 type.
- On VPIS-VO versions, the Voltage Output cable is a 1 m long MOLEX 79516 type cable, to be connected to the VPIS Voltage Adapter EMS59577. This adapter is connected to SC150 module using one of the three following Ethernet cables available (type S/STP or S/FTP):
 - CCA770 - length 0.6 m/1.97 ft (reference: 59660)
 - CCA772 - length 2 m/6.56 ft (reference: 59961)
 - CCA774 - length 4 m/13.12 ft (reference: 59962).

Installation recommendation

It is important to respect certain rules regarding the installation of the cable from cubicle coupling elements. It must be fixed so that in case of condensation, water flowing along the wires is guided to the ground and not to the wiring harness input of the VPIS.

Easergy VPIS V3

Mechanical Description

VPIS V3 references selection table

The range of use for each VPIS-V3 depends on Service voltage, network frequency and the switchgear capacitor. Here are typical range of use for 50Hz/60Hz. In case of use only for 50Hz or only 60Hz, the range of use could be expanded, please consult the switchgear offer manager.

		3 kV	6 kV	10 kV	15 kV	20 kV	30 kV	40 kV
SM6-24	First choice	VPI626x3 (2kV-4kV)	VPI626x4 (3.4 kV-6.3 kV)	VPI626x7 (9 kV-17 kV)	VPI626x7 (9 kV-17 kV)	VPI626x8 (13 kV-25 kV)		
	Second choice		VPI626x5 (4 kV-8 kV)	VPI626x6 (7 kV-13 kV)	VPI626x8 (13 kV-25 kV)			
RM6	First choice	VPI626x3 (2.5 kV-5 kV)	VPI626x4 (4 kV-7 kV)	VPI626x6 (8 kV-15 kV)	VPI626x7 (10.1 kV-24 kV)	VPI626x8 (17 kV-24 kV)		
	Second choice			VPI626x5 (5 kV-11 kV)		VPI626x7 (10.1 kV-24 kV)		
Ringmaster RN2D	First choice		VPI626x3 (3.3 kV-7.6 kV)	VPI626x5 (7.6 kV-13.8 kV)				
FBX C, RE, R, T1	First choice	VPI626x3 (3 kV-7 kV)	VPI626x3 (3 kV-7 kV)	VPI626x5 (6 kV-13 kV)	VPI626x6 (10 kV-24 kV)	VPI626x6 (10 kV-24 kV)		
FBX T2, CB	First choice	VPI626x6 (3 kV-7 kV)	VPI626x6 (3 kV-7 kV)	VPI626x8 (6 kV-13 kV)	VPI626x9 (12 kV-24 kV)	VPI626x9 (12 kV-24 kV)		

For VPI626x... references, x = 0 for the non VO VPIS variant, x = 1 for the VPIS VO variant.

(*) These references are no longer manufactured.

Commercial references

Reference	Designation
VPI62601	VPIS V3 LED VOLTAGE INDICATION 3.5 muA
VPI62602	VPIS V3 LED VOLTAGE INDICATION 5.1 muA
VPI62603	VPIS V3 LED VOLTAGE INDICATION 7.4 muA
VPI62604	VPIS V3 LED VOLTAGE INDICATION 10.7 muA
VPI62605	VPIS V3 LED VOLTAGE INDICATION 15.5 muA
VPI62606	VPIS V3 LED VOLTAGE INDICATION 22.4 muA
VPI62607	VPIS V3 LED VOLTAGE INDICATION 32.5 muA
VPI62608	VPIS V3 LED VOLTAGE INDICATION 47.2 muA
VPI62609	VPIS V3 LED VOLTAGE INDICATION 68.4 muA
VPI62611	VPIS V3 VO LED VOLTAGE INDICAT. 3.5 muA
VPI62612	VPIS V3 VO LED VOLTAGE INDICAT. 5.1 muA
VPI62613	VPIS V3 VO LED VOLTAGE INDICAT. 7.4 muA
VPI62614	VPIS V3 VO LED VOLTAGE INDICAT. 10.7 muA
VPI62615	VPIS V3 VO LED VOLTAGE INDICAT. 15.5 muA
VPI62616	VPIS V3 VO LED VOLTAGE INDICAT. 22.4 muA
VPI62617	VPIS V3 VO LED VOLTAGE INDICAT. 32.5 muA
VPI62618	VPIS V3 VO LED VOLTAGE INDICAT. 47.2 muA
VPI62619	VPIS V3 VO LED VOLTAGE INDICAT. 68.4 muA

