

NOTE: A newer document is available.

See [SD_100CT1902_SEC-03](#)

Visit [DigestPLUS](#) online for the most current Digest content

Section 3

Molded Case Circuit Breakers and Enclosures

PowerPact™ Circuit Breakers	3-2
PowerPact H- and J-Frame Circuit Breakers	3-2
PowerPact L-Frame Circuit Breakers	3-4
PowerPact™ Automatic Switches	3-5
PowerPact Automatic Switches	3-5
Molded Case Circuit Breakers	3-6
F-Frame Thermal-Magnetic Circuit Breakers	3-6
Q4-Frame Thermal-Magnetic Circuit Breakers	3-8
L-Frame Thermal-Magnetic Circuit Breakers	3-9
Mag-Gard™ Motor Circuit Protector	3-10
GJ-Frame MCP Selection	3-11
Special Construction Circuit Breakers	3-13
Special Terminal Connectors and Lugs	3-13
Special Calibration and Accessories	3-14
Special Terminations	3-16
Grounded BØ Systems	3-17
UL Marine Listed Circuit Breakers	3-18
Circuit Breaker Accessories	3-19
PowerPact™ Circuit Breakers Electrical Accessories	3-19
Factory-Installed Accessories	3-20
Field-Installable Accessories	3-21
Electrical Operators, Handle Accessories and Walking Beam Interlocks	3-22
Locks, Installation Accessories, and Rear Connections	3-23
Mechanical Lug Information	3-25
Compression Lug and Power Distribution Connectors	3-26
Electronic Products	3-26
Restraint Interface Module	3-27
Circuit Breaker Dimensions	3-28
Enclosures	3-29
Enclosed Switches and Enclosure Dimensions	3-29
Accessories	3-30
Key Interlock Systems—Factory Installed Only	3-31
California Proposition 65	3-32

PowerPact H- and J-Frame Circuit Breakers

Table 3.1: H-Frame 150 A UL Current-Limiting [1] Circuit Breaker Frame with Field-Interchangeable Thermal-Magnetic Trip Units [2] (600 Vac, 250 Vdc)

Ampere Rating	Fixed AC Magnetic Trip		Cat. No.				Terminal Wire Range
	Hold	Trip	D Interrupting	G Interrupting	J Interrupting [1]	L Interrupting [1]	
3P, 600 Vac 50/60 Hz							
15 A	350 A	750 A	HDL36015T	HGL36015T	HJL36015T	HLL36015T	AL150HD 14–3/0 AWG Al or Cu
20 A	350 A	750 A	HDL36020T	HGL36020T	HJL36020T	HLL36020T	
25 A	350 A	750 A	HDL36025T	HGL36025T	HJL36025T	HLL36025T	
30 A	350 A	750 A	HDL36030T	HGL36030T	HJL36030T	HLL36030T	
35 A	400 A	850 A	HDL36035T	HGL36035T	HJL36035T	HLL36035T	
40 A	400 A	850 A	HDL36040T	HGL36040T	HJL36040T	HLL36040T	
45 A	400 A	850 A	HDL36045T	HGL36045T	HJL36045T	HLL36045T	
50 A	400 A	850 A	HDL36050T	HGL36050T	HJL36050T	HLL36050T	
60 A	800 A	1450 A	HDL36060T	HGL36060T	HJL36060T	HLL36060T	
70 A	800 A	1450 A	HDL36070T	HGL36070T	HJL36070T	HLL36070T	
80 A	800 A	1450 A	HDL36080T	HGL36080T	HJL36080T	HLL36080T	
90 A	800 A	1450 A	HDL36090T	HGL36090T	HJL36090T	HLL36090T	
100 A	900 A	1700 A	HDL36100T	HGL36100T	HJL36100T	HLL36100T	
110 A	900 A	1700 A	HDL36110T	HGL36110T	HJL36110T	HLL36110T	
125 A	900 A	1700 A	HDL36125T	HGL36125T	HJL36125T	HLL36125T	
150 A	900 A	1700 A	HDL36150T	HGL36150T	HJL36150T	HLL36150T	

Table 3.2: J-Frame 250 A UL Current-Limiting [1] Circuit Breaker Frame with Field-Interchangeable Thermal-Magnetic Trip Units [2] (600 Vac, 250 Vdc)

Ampere Rating	Adjustable AC Magnetic Trip		Cat. No.				Terminal Wire Range
	Low	High	D Interrupting	G Interrupting	J Interrupting [1]	L Interrupting [1]	
3P, 600 Vac 50/60 Hz							
150 A	750 A	1500 A	JDL36150T	JGL36150T	JJL36150T	JLL36150T	AL175JD 4–4/0 AWG Al or Cu
175 A	875 A	1750 A	JDL36175T	JGL36175T	JJL36175T	JLL36175T	
200 A	1000 A	2000 A	JDL36200T	JGL36200T	JJL36200T	JLL36200T	AL250JD 3/0 AWG–350 kcmil Al or Cu
225 A	1125 A	2250 A	JDL36225T	JGL36225T	JJL36225T	JLL36225T	
250 A	1250 A	2500 A	JDL36250T	JGL36250T	JJL36250T	JLL36250T	

Table 3.3: H-Frame 150A and J-Frame 250 A 3P Basic UL Current-Limiting [1] Circuit Breaker Frame Without Terminations [3] or Trip Unit (600 Vac, 250 Vdc)

Circuit Breaker Frame	Ampere Rating	Cat. No.			
		D Interrupting	G Interrupting	J Interrupting [1]	L Interrupting [1]
H-Frame	15–60 A	HDF36000F06	HGF36000F06	HJF36000F06	HLF36000F06
	70–150 A	HDF36000F15	HGF36000F15	HJF36000F15	HLF36000F15
J-Frame	150–250 A	JDF36000F25	JGF36000F25	JJF36000F25	JLF36000F25

Table 3.4: H-Frame and J-Frame 3P Field-Installable Thermal-Magnetic Trip Unit

15–60 A H-Frame		70–150 A H-Frame		150–250 A J-Frame	
Amperage	Cat. No.	Amperage	Cat. No.	Amperage	Cat. No.
15 A	HT3015	70 A	HT3070	150 A	JT3150
20 A	HT3020	80 A	HT3080	175 A	JT3175
25 A	HT3025	90 A	HT3090	200 A	JT3200
30 A	HT3030	100 A	HT3100	225 A	JT3225
35 A	HT3035	110 A	HT3110	250 A	JT3250
40 A	HT3040	125 A	HT3125	—	—
45 A	HT3045	150 A	HT3150	—	—
50 A	HT3050	—	—	—	—
60 A	HT3060	—	—	—	—

Table 3.5: H- and J-Frame Interrupting Ratings

Voltage	Interrupting Rating			
	D	G	J	L
240 Vac	25 kA	65 kA	100 kA	125 kA
480 Vac	18 kA	35 kA	65 kA	100 kA
600 Vac	14 kA	18 kA	25 kA	50 kA

Table 3.6: H- and J-Frame Termination Options

Termination Letter	
A - I-Line (See Section 9)	
F = No Lugs (includes terminal nut kit on both ends) [4]	
L = Lugs both ends	
M = Lugs ON end Terminal Nut Kit OFF end	
P = Lugs OFF end Terminal Nut Kit ON end	
N = Plug-in	
D = Drawout	
S = Rear Connected	
For factory-installed termination, place termination letter in the third block of the circuit breaker catalog number. H D L 3 6 0 1 5 T	



H-Frame and Trip Unit

Accessories see Digest Section 7
Optional Lugs see Digest Section 7
Dimensions see Digest Section 7
Enclosures see Digest Section 7

[1] J and L interrupts are UL Certified as current limiting.
[2] Circuit breakers will be labeled with Line and Load markings and are not suitable for reverse connections. Available on 3P circuit breakers; not available on I-Line™ constructions. For 100% rated circuit breakers replace the “T” suffix with an “R” suffix. 100% rated is not available in I-Line, plug-in, or drawout constructions.
[3] See Digest Section 7 for lug and termination kits.
[4] Add TS suffix for circuit breaker without terminal nut kit.

3 MOLDED CASE CIRCUIT BREAKERS AND ENCLOSURES

PowerPact H- and J-Frame Circuit Breakers

Table 3.7: H-Frame 150 A and J-Frame 250 A Current-Limiting [5] Circuit Breakers with Lugs and Field-Interchangeable Electronic Trip Units (600 Vac, 50/60 Hz, 3P) [6]

Electronic Trip Unit			Sensor Rating	Cat. No.				Terminal Wire Range
Type	Function	Trip Unit		D Interrupting	G Interrupting	J Interrupting [5]	L Interrupting [5]	
Micrologic Standard	LI	3.2	60 A	HDL36060TU31X	HGL36060TU31X	HJL36060TU31X	HLL36060TU31X	AL150HD 14-3/0 AWG Al or Cu
			100 A	HDL36100TU31X	HGL36100TU31X	HJL36100TU31X	HLL36100TU31X	AL250JD 3/0 AWG-350 kcmil Al or Cu [7]
			150 A	HDL36150TU31X	HGL36150TU31X	HJL36150TU31X	HLL36150TU31X	
Micrologic Standard	LSI	3.2S	60 A	HDL36060TU33X	HGL36060TU33X	HJL36060TU33X	HLL36060TU33X	AL150HD 14-3/0 AWG Al or Cu
			100 A	HDL36100TU33X	HGL36100TU33X	HJL36100TU33X	HLL36100TU33X	AL250JD 3/0 AWG-350 kcmil Al or Cu [7]
			150 A	HDL36150TU33X	HGL36150TU33X	HJL36150TU33X	HLL36150TU33X	
Micrologic Ammeter	LSI	5.2A	60 A	HDL36060TU43X	HGL36060TU43X	HJL36060TU43X	HLL36060TU43X	AL150HD 14-3/0 AWG Al or Cu
			100 A	HDL36100TU43X	HGL36100TU43X	HJL36100TU43X	HLL36100TU43X	AL250JD 3/0 AWG-350 kcmil Al or Cu [7]
			150 A	HDL36150TU43X	HGL36150TU43X	HJL36150TU43X	HLL36150TU43X	
Micrologic Energy	LSI	5.2E	60 A	HDL36060TU53X	HGL36060TU53X	HJL36060TU53X	HLL36060TU53X	AL150HD 14-3/0 AWG Al or Cu
			100 A	HDL36100TU53X	HGL36100TU53X	HJL36100TU53X	HLL36100TU53X	AL250JD 3/0 AWG-350 kcmil Al or Cu [7]
			150 A	HDL36150TU53X	HGL36150TU53X	HJL36150TU53X	HLL36150TU53X	
Micrologic Ammeter	LSIG	6.2A	60 A	HDL36060TU44X	HGL36060TU44X	HJL36060TU44X	HLL36060TU44X	AL150HD 14-3/0 AWG Al or Cu
			100 A	HDL36100TU44X	HGL36100TU44X	HJL36100TU44X	HLL36100TU44X	AL250JD 3/0 AWG-350 kcmil Al or Cu [7]
			150 A	HDL36150TU44X	HGL36150TU44X	HJL36150TU44X	HLL36150TU44X	
Micrologic Energy	LSIG	6.2E	60 A	HDL36060TU54X	HGL36060TU54X	HJL36060TU54X	HLL36060TU54X	AL150HD 14-3/0 AWG Al or Cu
			100 A	HDL36100TU54X	HGL36100TU54X	HJL36100TU54X	HLL36100TU54X	AL250JD 3/0 AWG-350 kcmil Al or Cu [7]
			150 A	HDL36150TU54X	HGL36150TU54X	HJL36150TU54X	HLL36150TU54X	
			250 A	JDL36250TU54X	JGL36250TU54X	JJL36250TU54X	JLL36250TU54X	

Table 3.8: H-Frame 150A and J-Frame 250 A 3P Basic UL Current-Limiting [5] Circuit Breaker Frame Without Terminations [8] or Trip Unit (600 Vac, 250 Vdc)

Circuit Breaker Frame	Ampere Rating	Cat. No.			
		D Interrupting	G Interrupting	J Interrupting [5]	L Interrupting [5]
H-Frame	15-60 A	HDF36000F06	HGF36000F06	HJF36000F06	HLF36000F06
	70-150 A	HDF36000F15	HGF36000F15	HJF36000F15	HLF36000F15
J-Frame	150-250 A	JDF36000F25	JGF36000F25	JJF36000F25	JLF36000F25

Table 3.9: H- and J-Frame Interrupting Ratings

Voltage	Interrupting Rating			
	D	G	J	L
240 Vac	25 kA	65 kA	100 kA	125 kA
480 Vac	18 kA	35 kA	65 kA	100 kA
600 Vac	14 kA	18 kA	25 kA	50 kA

Table 3.10: Termination Letter

Termination Letter
A - I-Line (See Section 9)
F = No Lugs (includes terminal nut kit on both ends) [9]
L = Lugs both ends
M = Lugs ON end Terminal Nut Kit OFF end
P = Lugs OFF end Terminal Nut Kit ON end
N = Plug-in
D = Drawout
S = Rear Connected
HDL36015T
For factory-installed termination, place termination letter in the third block of the circuit breaker catalog number.
Accessories see Digest Section 7
Optional Lugs see Digest Section 7
Dimensions see Digest Section 7
Enclosures see Digest Section 7

Table 3.11: Micrologic Field-Installable Trip Unit

Model	Trip Function	Trip Unit	Continuous Current	Trip Unit Cat. No.
Micrologic Standard	LI	3.2	15-20-25-30-35-40-45-50-60	HE3060U31X
			35-40-45-50-60-70-80-90-100	HE3100U31X
			50-60-70-80-90-100-110-125-150	HE3150U31X
	LSI	3.2S	70-80-100-125-150-175-200-225-250	JE3250U31X
			15-20-25-30-35-40-45-50-60	HE3060U33X
			35-40-45-50-60-70-80-90-100	HE3100U33X
Micrologic Ammeter	LSI	5.2A	50-60-70-80-90-100-110-125-150	HE3150U33X
			70-80-100-125-150-175-200-225-250	JE3250U33X
			15-60	HE3060U43X
	LSIG	6.2A	35-100	HE3100U43X
			50-150	HE3150U43X
			70-250	JE3250U43X
Micrologic Energy	LSI	5.2E	15-60	HE3060U44X
			35-100	HE3100U44X
			50-150	HE3150U44X
	LSIG	6.2E	70-250	JE3250U44X
			15-60	HE3060U53X
			35-100	HE3100U53X
LSIG	6.2E	50-150	HE3150U53X	
		70-250	JE3250U53X	
		15-60	HE3060U54X	
LSIG	6.2E	35-100	HE3100U54X	
		50-150	HE3150U54X	
		70-250	JE3250U54X	

[5] J and L interrupts are UL Certified as current limiting.

[6] Circuit breakers will be labeled with Line and Load markings and are not suitable for reverse connections.

Available on 3P circuit breakers; not available on-Line™ constructions. For 100% rated circuit breakers replace the "T" suffix with an "R" suffix. 100% rated is not available in I-Line, plug-in, or drawout constructions.

[7] For smaller wire (4-4/0 AWG Al or Cu), replace the lug wire binding screws with longer binding screws provided.

[8] See Digest Section 7 for lug and termination kits.

[9] Add TS suffix for circuit breaker without terminal nut kit.

PowerPact L-Frame Molded Case Circuit Breaker

Table 3.12: L-Frame 3 Pole, 600 A Current-Limiting [10] Circuit Breakers with Lugs and Field-Interchangeable Electronic Trip Units (600 Vac, 50/60 Hz) [11][12]

Electronic Trip Unit			Sensor Rating	Cat. No.				Terminal Wire Range
Type	Function	Trip Unit		D Interrupting	G Interrupting	J Interrupting [10]	L Interrupting [10]	
Micrologic Standard	LI	3.3	250 A	LDL36250TU31X	LGL36250TU31X	LJL36250TU31X	LLL36250TU31X	AL400L61K3D (1) 2 AWG-600 kcmil Cu (1) 2 AWG-500 kcmil Al
			400 A	LDL36400TU31X	LGL36400TU31X	LJL36400TU31X	LLL36400TU31X	
			600 A	LDL36600TU31X	LGL36600TU31X	LJL36600TU31X	LLL36600TU31X	
Micrologic Standard	LSI	3.3S	250 A	LDL36250TU33X	LGL36250TU33X	LJL36250TU33X	LLL36250TU33X	AL400L61K3D (1) 2 AWG-600 kcmil Cu (1) 2 AWG-500 kcmil Al
			400 A	LDL36400TU33X	LGL36400TU33X	LJL36400TU33X	LLL36400TU33X	
			600 A	LDL36600TU33X	LGL36600TU33X	LJL36600TU33X	LLL36600TU33X	
Micrologic Ammeter	LSI	5.3A	400 A	LDL36400TU43X	LGL36400TU43X	LJL36400TU43X	LLL36400TU43X	AL600S52K3 (2) 2/0 AWG-500 kcmil Al/Cu
			600 A	LDL36600TU43X	LGL36600TU43X	LJL36600TU43X	LLL36600TU43X	
Micrologic Energy	LSI	5.3E	400 A	LDL36400TU53X	LGL36400TU53X	LJL36400TU53X	LLL36400TU53X	
			600 A	LDL36600TU53X	LGL36600TU53X	LJL36600TU53X	LLL36600TU53X	
Micrologic Ammeter	LSIG	6.3A	400 A	LDL36400TU44X	LGL36400TU44X	LJL36400TU44X	LLL36400TU44X	
			600 A	LDL36600TU44X	LGL36600TU44X	LJL36600TU44X	LLL36600TU44X	
Micrologic Energy	LSIG	6.3E	400 A	LDL36400TU54X	LGL36400TU54X	LJL36400TU54X	LLL36400TU54X	
			600 A	LDL36600TU54X	LGL36600TU54X	LJL36600TU54X	LLL36600TU54X	

Table 3.13: L-Frame 3 Pole, 600 A Circuit Breaker Frame without Terminations or Trip Unit (600 Vac, 50/60 Hz) [13]

Ampere Rating	Interrupting Rating			
	D	G	J	L
250 A (70-250 A)	LDF36000F25	LGF36000F25	LJF36000F25	LLF36000F25
400 A (125-400 A)	LDF36000F40	LGF36000F40	LJF36000F40	LLF36000F40
600 A (200-600 A)	LDF36000F60	LGF36000F60	LJF36000F60	LLF36000F60

Table 3.14: Termination Options

Termination Letter	Termination Option
A	I-Line (See Section 9)
F	No lugs (includes terminal nut kit on both ends)
L	Lugs both ends
M	Lugs ON end, terminal nut kit OFF end
P	Lugs OFF end, terminal nut kit ON end
N	Plug In
D	Drawout
S	Rear Connected

For factory-installed termination, place termination letter in the third block of the circuit breaker catalog number.
J G L 3 6 2 5 0 or L G L 3 6 6 0 0 U 4 4 X

Accessories see Digest Section 7
Optional Lugs see Digest Section 7
Dimensions see Digest Section 7

Table 3.15: L-Frame 3P Field-Installable Micrologic Electronic Trip Units

Electronic Trip Unit			Continuous Current	Trip Unit Cat. No.
Type	Function	Code		
Micrologic Standard	LI	3.3	70-80-100-125-150-175-200-225-250	LE3250U31X
			125-150-175-200-225-250-300-350-400	LE3400U31X
			200-225-250-300-350-400-450-500-600	LE3600U31X
Micrologic Standard	LSI	3.3S	70-80-100-125-150-175-200-225-250	LE3250U33X
			125-150-175-200-225-250-300-350-400	LE3400U33X
			200-225-250-300-350-400-450-500-600	LE3600U33X
Micrologic Ammeter	LSI	5.3A	125-400	LE3400U43X
	LSIG	6.3A	200-600	LE3600U43X
Micrologic Energy	LSI	5.3E	125-400	LE3400U53X
	LSIG	6.3E	200-600	LE3600U53X

Table 3.16: L-Frame Interrupting Ratings

Voltage	Interrupting Rating			
	D	G	J	L
240 Vac	25 kA	65 kA	100 kA	125 kA
480 Vac	18 kA	35 kA	65 kA	100 kA
600 Vac	14 kA	18 kA	25 kA	50 kA

[10] J and L interrupts are UL Certified as current limiting.

[11] Circuit breakers will be labeled with Line and Load markings and are not suitable for reverse connections.

[12] Only available on 3P unit-mount circuit breakers. Not allowed on I-Line constructions. For 100% rated field-interchangeable circuit breakers, replace the "T" suffix with an "R". 100% field-interchangeable circuit breakers are not allowed on 600 A I-Line, Plug-In, or Drawout constructions.

[13] See Digest Section 7 for lug and termination kits.

Automatic Switches

Automatic molded case switches open instantaneously at a factory preset magnetic trip point, calibrated to protect only the molded case switch itself, when it is subjected to high fault currents. The trip point is nonadjustable and provides no overload or low level fault protection.

Molded case switches open when the handle is switched to the OFF position or in response to an auxiliary tripping device such as a shunt trip.

All molded case switches will accept the same lugs and accessories as equivalent thermal-magnetic circuit breakers, with the exception of Q-frame switches which do not have electrical accessories available.

Automatic molded case switches are UL Listed per UL 489 and are CSA Certified.

Table 3.17: Q-Frame (240 Vac) PowerPact™ Automatic Molded Case Switches

Circuit Breaker	Poles	Ampere Rating	J Interrupting Rating		Terminal	Wire Range
			Cat. No.	Trip Point		
Q-Frame [1]	2	225 A	QBL22000S22	4500 A		4 AWG–300 kcmil
	3	225 A	QBL32000S22	4500 A		

[1] Withstand rating of 10 kA at 240 Vac.

F-Frame Circuit Breakers Ending Production in 2018–2019

PowerPact B-Frame 15–125 A molded case circuit breakers are the designated replacement for F-frame applications. The PowerPact B-frame features increased capacity, a smaller size in unit mount, same size in I-Line applications to ease retrofit, and a flexible range of field-installable accessories, auxiliaries and operators.

F-Frame Molded Case Circuit Breakers

Thermal-magnetic molded case circuit breakers shown here are permanent trip UL Listed, CSA Certified, IEC rated, and also meet the requirements of Federal Specification W–C–375B/GEN as indicated in Digest Section 7.

NOTE: Consider using PowerPact™ circuit breakers for situations requiring circuit breaker accessories. See Digest Section 7 for more information.



Table 3.19: F-Frame—100 A, Thermal-Magnetic, Individually-Mounted, Standard Interrupting, 240 Vac

Ampere Rating	Fixed AC Magnetic Trip		Cat. No.			Terminal Wire Range (AWG)
	Hold	Trip	1 P 120 Vac	2 P 240 Vac	3 P 240 Vac	
15 A	275 A	600 A	FAL12015	FAL22015	FAL32015	AL50FA 14–4 Cu or 12–4 Al
20 A	275 A	600 A	FAL12020	FAL22020	FAL32020	
25 A	275 A	600 A	FAL12025	FAL22025	FAL32025	
30 A	275 A	600 A	FAL12030	FAL22030	FAL32030	
35 A	400 A	850 A	FAL12035	FAL22035	FAL32035	
40 A	400 A	850 A	FAL12040	FAL22040	FAL32040	AL100FA 14–1/0 Cu or 12–1/0 Al
45 A	400 A	850 A	FAL12045	FAL22045	FAL32045	
50 A	400 A	850 A	FAL12050	FAL22050	FAL32050	
60 A	800 A	1450 A	FAL12060	FAL22060	FAL32060	
70 A	800 A	1450 A	FAL12070	FAL22070	FAL32070	
80 A	800 A	1450 A	FAL12080	FAL22080	FAL32080	
90 A	900 A	1700 A	FAL12090	FAL22090	FAL32090	
100 A	900 A	1700 A	FAL12100	FAL22100	FAL32100	

Table 3.18: Termination Option

Termination Letter
F = No Lugs
L = Lugs both ends
P with MT Suffix = Lugs ON end
P = Lugs OFF end
F A L 3 6 1 0 0
For factory-installed termination, place termination letter in the third block of the circuit breaker catalog number.

Table 3.20: F-Frame—100 A, Thermal-Magnetic, Individually-Mounted, 480 Vac

Ampere Rating	Fixed AC Magnetic Trip		Standard Interrupting Cat. No.			Terminal
	Hold	Trip	1P 277 Vac, 125 Vdc	2P 480 Vac, 250 Vdc	3P 480 Vac, 250 Vdc	
15 A	275 A	600 A	FAL14015	FAL24015	FAL34015	AL50FA (1) 14–4 Cu or (1) 12–4 Al
20 A	275 A	600 A	FAL14020	FAL24020	FAL34020	
25 A	275 A	600 A	FAL14025	FAL24025	FAL34025	
30 A	275 A	600 A	FAL14030	FAL24030	FAL34030	
35 A	400 A	850 A	FAL14035	FAL24035	FAL34035	
40 A	400 A	850 A	FAL14040	FAL24040	FAL34040	AL100FA (1) 14–1/0 Cu or (1) 12–1/0 Al
45 A	400 A	850 A	FAL14045	FAL24045	FAL34045	
50 A	400 A	850 A	FAL14050	FAL24050	FAL34050	
60 A	800 A	1450 A	FAL14060	FAL24060	FAL34060	
70 A	800 A	1450 A	FAL14070	FAL24070	FAL34070	
80 A	800 A	1450 A	FAL14080	FAL24080	FAL34080	
90 A	900 A	1700 A	FAL14090	FAL24090	FAL34090	
100 A	900 A	1700 A	FAL14100	FAL24100	FAL34100	

Table 3.21: F-Frame—100 A, Thermal-Magnetic, Individually-Mounted, 600 Vac

Ampere Rating	Fixed AC Magnetic Trip		Cat. No.						Terminal Wire Range (AWG)	
			Standard Interrupting		High Interrupting			Current Limiting		
	Hold	Trip	2P 600 Vac, 250 Vdc	3P 600 Vac, 250 Vdc	1P 277 Vac, 125 Vdc	2P 600 Vac, 250 Vdc	3P 600 Vac, 250 Vdc	2P 600 Vac, 250 Vdc		3P 600 Vac, 250 Vdc
15 A	275 A	600 A	FAL26015	FAL36015	FHL16015	FHL26015	FHL36015	—	—	AL50FA 14–4 Cu or 12–4 Al
20 A	275 A	600 A	FAL26020	FAL36020	FHL16020	FHL26020	FHL36020	FIL26020	FIL36020	
25 A	275 A	600 A	FAL26025	FAL36025	FHL16025	FHL26025	FHL36025	FIL26025	FIL36025	
30 A	275 A	600 A	FAL26030	FAL36030	FHL16030	FHL26030	FHL36030	FIL26030	FIL36030	
35 A	400 A	850 A	FAL26035	FAL36035	FHL16035	FHL26035	FHL36035	FIL26035	FIL36035	
40 A	400 A	850 A	FAL26040	FAL36040	FHL16040	FHL26040	FHL36040	FIL26040	FIL36040	AL100FA 14–1/0 Cu or 12–1/0 Al
45 A	400 A	850 A	FAL26045	FAL36045	FHL16045	FHL26045	FHL36045	FIL26045	FIL36045	
50 A	400 A	850 A	FAL26050	FAL36050	FHL16050	FHL26050	FHL36050	FIL26050	FIL36050	
60 A	800 A	1450 A	FAL26060	FAL36060	FHL16060	FHL26060	FHL36060	FIL26060	FIL36060	
70 A	800 A	1450 A	FAL26070	FAL36070	FHL16070	FHL26070	FHL36070	FIL26070	FIL36070	
80 A	800 A	1450 A	FAL26080	FAL36080	FHL16080	FHL26080	FHL36080	FIL26080	FIL36080	
90 A	900 A	1700 A	FAL26090	FAL36090	FHL16090	FHL26090	FHL36090	FIL26090	FIL36090	
100 A	900 A	1700 A	FAL26100	FAL36100	FHL16100	FHL26100	FHL36100	FIL26100	FIL36100	

Table 3.22: Interrupting Ratings

Voltage	FAL			FHL	FCL [1]	FIL
	240 Vac	480 Vac	600 Vac			
240 Vac	10 kA	18 kA (1P) 25 kA (2P, 3P)	25 kA	25 kA (1P) 65 kA (2P, 3P)	100 kA	200 kA
480 Vac	—	18 kA	18 kA	25 kA (2P, 3P)	65 kA	200 kA
600 Vac	—	—	14 kA	18 kA (2P, 3P)	—	100 kA

Accessories see page 3-19 through page 3-26
Optional Lugs see page 3-25
Dimensions see page 3-28
Enclosures see Digest Section 7

[1] See Section 11.



F-Frame I-Line Circuit Breakers

NOTE: Consider using PowerPact™ circuit breakers for situations requiring circuit breaker accessories. See Digest Section 7 for more information.

Table 3.23: F-Frame—100 A, Thermal-Magnetic, I-Line™ Construction, 240 Vac, Standard Interrupting

Ampere Rating	Fixed AC Magnetic Trip		Cat. No.		Terminal Wire Range (AWG)
	Hold	Trip	2 P [2] 240 Vac	3 P 240 Vac	
15 A	275 A	600 A	FA22015()	FA32015	AL50FA 14–4 Cu or 12–4 Al
20 A	275 A	600 A	FA22020()	FA32020	
25 A	275 A	600 A	FA22025()	FA32025	
30 A	275 A	600 A	FA22030()	FA32030	AL100FA 14–1/0 Cu or 12–1/0 Al
35 A	400 A	850 A	FA22035()	FA32035	
40 A	400 A	850 A	FA22040()	FA32040	
45 A	400 A	850 A	FA22045()	FA32045	
50 A	400 A	850 A	FA22050()	FA32050	
60 A	800 A	1450 A	FA22060()	FA32060	
70 A	800 A	1450 A	FA22070()	FA32070	
80 A	800 A	1450 A	FA22080()	FA32080	
90 A	900 A	1700 A	FA22090()	FA32090	
100 A	900 A	1700 A	FA22100()	FA32100	

Table 3.24: F-Frame—100 A, Thermal-Magnetic, I-Line Construction, 480 Vac

Ampere Rating	Fixed AC Magnetic Trip		Standard Interrupting			Terminal Wire Range (AWG)
	Hold	Trip	1P [2][3] 277 Vac, 125 Vdc	2P [2] 480 Vac, 250 Vdc	3P 480 Vac, 250 Vdc	
15 A	275 A	600 A	—	FA24015()	FA34015	AL50FA (1) 14–4 Cu or (1) 12–4 Al
20 A	275 A	600 A	—	FA24020()	FA34020	
25 A	275 A	600 A	—	FA24025()	FA34025	
30 A	275 A	600 A	—	FA24030()	FA34030	AL100FA (1) 14–1/0 Cu or (1) 12–1/0 Al
35 A	400 A	850 A	FA14035()	FA24035()	FA34035	
40 A	400 A	850 A	FA14040()	FA24040()	FA34040	
45 A	400 A	850 A	FA14045()	FA24045()	FA34045	
50 A	400 A	850 A	FA14050()	FA24050()	FA34050	
60 A	800 A	1450 A	FA14060()	FA24060()	FA34060	
70 A	800 A	1450 A	FA14070()	FA24070()	FA34070	
80 A	800 A	1450 A	FA14080()	FA24080()	FA34080	
90 A	900 A	1700 A	FA14090()	FA24090()	FA34090	
100 A	900 A	1700 A	FA14100()	FA24100()	FA34100	

Table 3.25: F-Frame—100 A, Thermal-Magnetic, I-Line™ Construction, 600 Vac

Ampere Rating	Fixed AC Magnetic Trip		Cat. No.						Terminal Wire Range (AWG)	
	Hold	Trip	Standard Interrupting		High Interrupting		Current Limiting			
			2P [2] 600 Vac, 250 Vdc	3P 600 Vac, 250 Vdc	1P [2][3] 277 Vac, 125 Vdc	2P [2] 600 Vac, 250 Vdc	3P 600 Vac, 250 Vdc	2P [2] 600 Vac, 250 Vdc		3P 600 Vac, 250 Vdc
15 A	275 A	600 A	FA26015()	FA36015	FH16015()	FH26015()	FH36015	—	—	AL50FA 14–4 Cu or 12–4 Al
20 A	275 A	600 A	FA26020()	FA36020	FH16020()	FH26020()	FH36020	FI26020()	FI36020	
25 A	275 A	600 A	FA26025()	FA36025	FH16025()	FH26025()	FH36025	—	—	
30 A	275 A	600 A	FA26030()	FA36030	FH16030()	FH26030()	FH36030	FI26030()	FI36030	AL100FA 14–1/0 Cu or 12–1/0 Al
35 A	400 A	850 A	FA26035()	FA36035	FH16035()	FH26035()	FH36035	—	—	
40 A	400 A	850 A	FA26040()	FA36040	FH16040()	FH26040()	FH36040	FI26040()	FI36040	
45 A	400 A	850 A	FA26045()	FA36045	FH16045()	FH26045()	FH36045	—	—	
50 A	400 A	850 A	FA26050()	FA36050	FH16050()	FH26050()	FH36050	FI26050()	FI36050	
60 A	800 A	1450 A	FA26060()	FA36060	FH16060()	FH26060()	FH36060	FI26060()	FI36060	
70 A	800 A	1450 A	FA26070()	FA36070	FH16070()	FH26070()	FH36070	FI26070()	FI36070	
80 A	800 A	1450 A	FA26080()	FA36080	FH16080()	FH26080()	FH36080	FI26080()	FI36080	
90 A	900 A	1700 A	FA26090()	FA36090	FH16090()	FH26090()	FH36090	FI26090()	FI36090	
100 A	900 A	1700 A	FA26100()	FA36100	FH16100()	FH26100()	FH36100	FI26100()	FI36100	

Table 3.26: Phase Options

Phase Option Letter	1P	2P	3P
A B C	FA14035A FA14035B FA14035C	—	—
AB AC BC	—	FA24030AB FA24030AC FA24030BC	—
ABC CBA	—	—	FA34030 FA34030CBA

Table 3.27: Interrupting Ratings

Voltage	FA			FH	FC[4]	FI
	240 Vac	480 Vac	600 Vac			
240 Vac	10 kA	18 kA (1P), 25 kA (2P, 3P)	25 kA	25 kA (1P) 65 kA (2P, 3P)	100 kA	200 kA
277 Vac	—	18 kA	—	—	65 kA	—
480 Vac	—	18 kA	18 kA	25 kA (2P, 3P)	65 kA	200 kA
600 Vac	—	—	14 kA	18 kA (2P, 3P)	—	100 kA

Accessories see page 3-19 through page 3-26
Optional Lugs see page 3-25
Dimensions see page 3-28
Enclosures see Digest Section 7

[2] 1P and 2P circuit breaker catalog numbers are completed by adding the required phase connection letters as a suffix. See Phase Option Table.
[3] Rated 277 Vac, 125 Vdc, 15–30 A circuit breaker suitable for use with 60°C or 75°C conductors. 35–100 A circuit breakers are suitable for use with 75°C conductors.
[4] See Section 11.

Q4-Frame

NOTE: Consider using PowerPact™ circuit breakers for situations requiring circuit breaker accessories. See Digest Section 7 for more information.



Q4L
2P and 3P
250–400 A

Table 3.28: Q4-Frame—400 A, Thermal-Magnetic, Individually-Mounted, 240 Vac

Ampere Rating	Adjustable AC Magnetic Trip [5]		Standard Interrupting Cat. No.	Terminal Wire Range
	Low	High		
2P, 240 Vac				
250	1250 A	2500 A	Q4L2250	AL400LA (1) 1 AWG–600 kcmil Al or (2) 1 AWG–250 kcmil Al
300	1500 A	3000 A	Q4L2300	
350	1750 A	3500 A	Q4L2350	
400	2000 A	4000 A	Q4L2400	
3P, 240 Vac				
250	1250 A	2500 A	Q4L3250	AL400LA (1) 1 AWG–600 kcmil Al or (2) 1 AWG–250 kcmil Al
300	1500 A	3000 A	Q4L3300	
350	1750 A	3500 A	Q4L3350	
400	2000 A	4000 A	Q4L3400	

NOTE: Consider using PowerPact circuit breakers for situations requiring circuit breaker accessories. See Digest Section 7 for more information.

Table 3.29: Q4-Frame—400 A, Thermal-Magnetic, I-Line™ Construction, 240 Vac

Ampere Rating	Adjustable AC Magnetic Trip [5]		Standard Interrupting Cat. No.	Terminal Wire Range
	Low	High		
2P, 240 Vac[6]				
250	1250 A	2500 A	Q422250()	AL400LA (1) 1 AWG–600 kcmil Al or (2) 1 AWG–250 kcmil Al
300	1500 A	3000 A	Q422300()	
350	1750 A	3500 A	Q422350()	
400	2000 A	4000 A	Q422400()	
3P, 240 Vac				
250	1250 A	2500 A	Q432250	AL400LA (1) 1 AWG–600 kcmil Al or (2) 1 AWG–250 kcmil Al
300	1500 A	3000 A	Q432300	
350	1750 A	3500 A	Q432350	
400	2000 A	4000 A	Q432400	



Q4 2P and 3P
6 in. (152 mm)
Mounting Height

Table 3.30: Interrupting Ratings

Voltage	KI	Q4
240 Vac	200 kA	25 kA
480 Vac	200 kA	—
600 Vac	100 kA	—

Accessories see page 3-19 through page 3-26

Optional Lugs see page 3-25

Dimensions see page 3-28

Enclosures see Digest Section 7

[5] UL magnetic trip setting tolerances are ±25% for low and ±20% for high from nominal value shown.

[6] 2P and 3P circuit breaker catalog numbers are completed by adding the required phase connection letters as a suffix. See Phase Option Table.



LAL/LHL
2P and 3P
125–400 A

L-Frame Molded Case Circuit Breaker

NOTE: Consider using PowerPact™ circuit breakers for situations requiring circuit breaker accessories. See Digest Section 7 for more information.

Table 3.31: L-Frame—600 A, Thermal-Magnetic, Individually-Mounted Circuit Breakers, 600 Vac

Ampere Rating	Adjustable AC Magnetic Trip		Cat. No.		Terminal Wire Range
	Low	High	Standard Interrupting	High Interrupting	
2P, 600 Vac, 250 Vdc					
125 A	625 A	1250 A	LAL26125	LHL26125	AL400LA (1) 1 AWG–600 kcmil Al or (2) 1 AWG–250 kcmil Al
150 A	750 A	1500 A	LAL26150	LHL26150	
175 A	875 A	1750 A	LAL26175	LHL26175	
200 A	1000 A	2000 A	LAL26200	LHL26200	
225 A	1125 A	2250 A	LAL26225	LHL26225	
250 A	1250 A	2500 A	LAL26250	LHL26250	
300 A	1500 A	3000 A	LAL26300	LHL26300	
350 A	1750 A	3500 A	LAL26350	LHL26350	
400 A	2000 A	4000 A	LAL26400	LHL26400	
3P, 600 Vac, 250 Vdc					
125 A	625 A	1250 A	LAL36125	LHL36125	AL400LA (1) 1 AWG–600 kcmil Al or (2) 1 AWG–250 kcmil Al
150 A	750 A	1500 A	LAL36150	LHL36150	
175 A	875 A	1750 A	LAL36175	LHL36175	
200 A	1000 A	2000 A	LAL36200	LHL36200	
225 A	1125 A	2250 A	LAL36225	LHL36225	
250 A	1250 A	2500 A	LAL36250	LHL36250	
300 A	1500 A	3000 A	LAL36300	LHL36300	
350 A	1750 A	3500 A	LAL36350	LHL36350	
400 A	2000 A	4000 A	LAL36400	LHL36400	

Table 3.32: Interrupting Ratings

Voltage	LAL	LHL	LCL	LIL
240 Vac	42 kA	65 kA	100 kA	200 kA
480 Vac	30 kA	35 kA	65 kA	200 kA
600 Vac	22 kA	25 kA	35 kA	100 kA

Accessories see page 3-19 through page 3-26
Optional Lugs see page 3-25
Dimensions see page 3-28
Enclosures see Digest Section 7

Mag-Gard Motor Circuit Protector

Instantaneous trip magnetic only circuit breakers have a single adjustment which simultaneously sets the magnetic trip level of each individual pole. Mag-Gard circuit breakers comply with NEC® requirements for providing motor circuit protection when installed as part of a UL Listed combination controller having motor overload protection. Interrupting ratings are established for these UL Recognized Components only when they are used in combination with motor starters with properly sized overload relays and contactors.

Mag-Gard circuit breakers will accept the same lugs and accessories as equivalent thermal-magnetic circuit breakers.

Table 3.33: Magnetic Only LAL Mag-Gard, 400 A, 600 Vac, 50/60 Hz [7]

Ampere Rating		Adjustable [8] Trip Range	Cat. No. 3P Only
GJL [9]	3	9–33 A	GJL36003M01
	7	21–77 A	GJL36007M02
	15	45–165 A	GJL36015M03
	30	90–330 A	GJL36030M04
	50	150–550 A	GJL36050M05
	75	225–825 A	GJL36075M06

NOTE: Each ampere rating can be ordered with any designated trip range for the frame by adding the proper suffix to the catalog numbers.

Table 3.34: Special Low Mags Magnetic Trip Settings for PowerPact H- and J-Frame Thermal Magnetic Circuit Breakers 70–125 A

Amps	Special Low Mags		Ii on Label	Mag Suffix	Interrupting Rating			
	Hold [10]	Trip [10]			D	G	J	L
70	400	850	625	H83	HDL36070H83	HGL36070H83	HJL36070H83	HLL36070H83
80	400	850	625	H83	HDL36080H83	HGL36080H83	HJL36080H83	HLL36080H83
90	400	850	625	H83	HDL36090H83	HGL36090H83	HJL36090H83	HLL36090H83
100	400	850	625	H83	HDL36100H83	HGL36100H83	HJL36100H83	HLL36100H83
110	400	850	625	H83	HDL36110H83	HGL36110H83	HJL36110H83	HLL36110H83
125	800	1450	1125	H84	HDL36125H84	HGL36125H84	HJL36125H84	HLL36125H84

Table 3.35: Special High Mags Magnetic Trip Settings for PowerPact H- and J-Frame Thermal Magnetic Circuit Breakers

Amps	Special High Mags		Ii on Label	Mag Suffix	Interrupting Rating			
	Hold [10]	Trip [10]			D	G	J	L
90	900	1700	1300	H85	HDL36090H85	HGL36090H85	HJL36090H85	HLL36090H85

Table 3.36: Special Low Mags Magnetic Trip Settings for PowerPact H- and J-Frame Thermal Magnetic Circuit Breakers 150–200 A

Amps	Special Low Mags		Ii on Label	Mag Suffix	Interrupting Rating			
	Low [11]	High [11]			D	G	J	L
150	875L	1750H		H29	JDL36150H29	JGL36150H29	JJL36150H29	JLL36150H29
200	1250L	2500H		H32	JDL36200H32	JGL36200H32	JJL36200H32	JLL36200H32

Table 3.37: H- and J-Frame Interrupting Ratings

Voltage	Interrupting Rating			
	D	G	J	L
240 Vac	25 kA	65 kA	100 kA	125 kA
480 Vac	18 kA	35 kA	65 kA	100 kA
600 Vac	14 kA	18 kA	25 kA	50 kA

Accessories see page 3-19 through page 3-26
Optional Lugs see page 3-25
Dimensions see page 3-28

[7] 250 Vdc ratings are available. No UL component recognition.
[8] UL magnetic trip setting tolerances are -20%/+30% from the nominal values shown.
[9] No GJL I-Line available.
[10] Hold and Trip indicate fixed magnetic trip levels
[11] Low and High refer to adjustable mag level setting.



GJL MCP Selection

Adjustable instantaneous-trip circuit breakers are intended for use in combination with motor starters with overload relays for the protection of motor circuits from short circuits. Other specific applications include rectifiers and resistance welders. These circuit breakers contain a magnetic trip element in each pole with the trip point adjustable from the front. Interrupting ratings are determined by testing the instantaneous-trip circuit breakers in combination with a contactor and overload relay.

Select instantaneous-trip circuit breakers as follows:

This selection table is suitable for motors, other than NEMA Design E, with locked-rotor indicating code letters per NEC® Table 430.7 (b) as follows:

Table 3.38: Locked-Rotor Indicating Codes

Horsepower	Motor Code letter
1/2 or less	A-L
3/4 to 1-1/2	A-K
2 to 3	A-J
5 to 25	A-H
30 to 125	A-G
150 or more	A-F

- For other motors order a special thermal-magnetic circuit breaker with magnetic trip settings for the specific motor— specify motor horsepower, voltage, frequency, full-load current and code letter or locked rotor current.
- Determine motor hp rating from the motor nameplate.
- Refer to the tables and select an instantaneous-trip circuit breaker with an ampere rating recommended for the hp and voltage involved.
- Select an adjustable trip setting of at least 800%, not to exceed 1300%, of the motor full-load amperes (FLA) for other than Design E motors. For Design E motors, select an adjustable trip setting of at least 1100% not to exceed 1700% of FLA.
- The NEC 1300% maximum setting may be inadequate for instantaneous-trip circuit breakers to withstand current surges typical of the magnetization current of autotransformer type reduced voltage starters, or open transition wye-delta starters during transfer from “start” to “run,” constant hp multi-speed motors, and motors labeled “high efficiency.” Select thermal-magnetic circuit breakers from Digest Section 7 for those applications.
- Part-winding motors, per NEC 430.3, should have two circuit breakers selected from the above at not more than one half the allowable trip setting for the horsepower rating. The two circuit breakers should operate simultaneously as a disconnecting means per NEC 430.103.
- Based on NEC 430.52 and NEC Table 430.150. See Digest Section 7 for a available Adjustable Instantaneous-Trip Circuit Breakers.

GJL MCP Selection Table

Table 3.39: GJL Adjustable Instantaneous-Trip Circuit Breakers for Single Motor Circuit Protection

Hp Ratings of Induction Type Squirrel-Cage and Wound Rotor Motors 3Ø 60 Hz				Full Load Amperes [12]	GJL Family Mag-Gard Circuit Breaker Cat. No.	Magnetic Trip Settings [13]	
200 Vac	230 Vac	460 Vac	575 Vac			MIN	MAX
			1/2	0.8	GJL36003M01 [14]	1100%	4100%
		1/2		1	GJL36003M01 [14]	900%	3300%
			3/4	1.1	GJL36003M01 [14]	800%	3000%
		3/4		1.4	GJL36003M01	600%	2400%
		1		1.8	GJL36003M01	500%	1800%
	1/2			2	GJL36003M01	500%	1700%
			1-1/2	2.1	GJL36003M01	400%	1600%
1/2				2.3	GJL36003M01	400%	1400%
		1-1/2		2.6	GJL36003M01	300%	1300%
			2	2.7	GJL36003M01 [15]	300%	1200%
	3/4			2.8	GJL36003M01 [15]	300%	1200%
3/4		2		3.2	GJL36007M02	700%	2400%
				3.4	GJL36007M02	600%	2300%
	1			3.6	GJL36007M02	600%	2100%
			3	3.9	GJL36007M02	500%	2000%
1				4.1	GJL36007M02	500%	1900%
		3		4.8	GJL36007M02	400%	1600%
	1-1/2			5.2	GJL36007M02	400%	1500%
1-1/2				6	GJL36007M02	400%	1300%
			5	6.1	GJL36015M03	700%	2700%
	2			6.8	GJL36015M03	700%	2400%
		5		7.6	GJL36015M03	600%	2200%
2				7.8	GJL36015M03	600%	2100%
			7-1/2	9	GJL36015M03	500%	1800%
	3			9.6	GJL36015M03	500%	1700%
3		7-1/2	10	11	GJL36015M03	400%	1500%
		10		14	GJL36030M04	600%	2400%
	5			15.2	GJL36030M04	600%	2200%
			1	17	GJL36030M04	500%	1900%
5				17.5	GJL36030M04	500%	1900%
		15		21	GJL36030M04	400%	1600%
	7-1/2		20	22	GJL36030M04	400%	1500%
7-1/2				25.3	GJL36030M04	400%	1300%
		20	25	27	GJL36050M05	600%	2000%
	10			28	GJL36050M05	500%	2000%
			30	32	GJL36050M05	500%	1700%
10				32.2	GJL36050M05	500%	1700%
		25		34	GJL36050M05	400%	1600%
		30		40	GJL36050M05	400%	1400%
			40	41	GJL36050M05	400%	1300%
	15			42	GJL36075M06	400%	1300%
				48.3	GJL36075M06	500%	1700%
		40	50	52	GJL36075M06	400%	1600%
	20			54	GJL36075M06	400%	1500%
20			60	62	GJL36075M06	400%	1300%
		50		65	GJL36075M06	300%	1300%

3 MOLDED CASE CIRCUIT BREAKERS AND ENCLOSURES

[12] Motor full-load currents are taken from NEC Table 430.150. Select wire and circuit breakers on basis of horsepower rather than nameplate full-load current per NEC 430.6 (A) for general motor applications. Do not use these values to select overload relay thermal units. See Digest Section 14 for selection of thermal units when actual full load current is not known. The voltages listed are rated motor voltages. Corresponding nominal system voltages are 200–208, 220–240, 440–480 and 550–600 V.

[13] Only MIN and MAX settings are shown, intermediate settings are available on all circuit breakers.

[14] See NEC 430.52(A) for circuit breaker settings above 800%.

[15] If due to motor starting characteristics, trip settings at the 1300% maximum permitted level are needed, the next size Mag-Gard circuit breaker should be chosen.

I-Line™ Special Terminal Connectors

Bolt-On I-Line Circuit Breakers

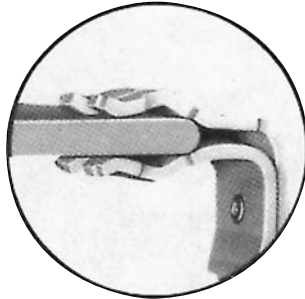

Plug-On Connector

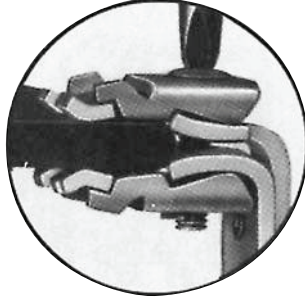

Bolted Connector

The standard I-Line circuit breaker is designed to provide a high quality, secure connection between the distribution bus and circuit breaker. I-Line circuit breakers use plug-on type line-side connectors. The parallel line-side connectors “clamp” around the bus bars. In case of a short circuit, the increased magnetic flux causes the connectors to grasp the bus bars even tighter. I-Line circuit breakers with bolted connections have clamp-on jaws that are bolted around the main bus, as shown. The bolt-on I-Line design is offered as an alternative in order to meet specifications requiring a bolted connection. Bolt-on I-Line construction is available on FY, QB, QD, QG, QJ, Q4, FA, FH, FI, KI, LA, and LH frame circuit breakers and molded case switches, and SL100, SL225 and SL400 sub-feed lugs.

To order on all products except QB, QD, QG and QJ, simply add the letter “B” in the catalog number prefix of the circuit breaker, e.g., FA36100 becomes FAB36100. For QB, QD, QG and QJ, insert the letter “E” in the third position, e.g., QBE, QDE, etc.

NOTE: Not available on Powerpact™ circuit breakers.

Top-Feed I-Line Circuit Breakers

I-Line panelboards may require the use of a top-feed I-Line circuit breaker in applications where a top-feed main circuit breaker is required. This involves having the I-Line jaw connectors on the OFF end of the circuit breaker, as opposed to the standard location on the ON end of the circuit breaker. To designate this construction, simply place the suffix “MT” at the end of the circuit breaker catalog number, e.g., FA36100 becomes FA36100MT. On LA or LH top-feed I-Line circuit breakers, accessories must be factory installed. This option is available in PowerPact™ H and J-frame by placing a “K” in the 4th position (termination indicator) of the circuit breaker catalog number, e.g., HGA36125 becomes HGK36125. This option is not available on L-frame (600 A only), M-frame, N-Frame or Powerpact M-, P- and R-frame.

“CBA” I-Line Jaw Configuration (Non-PowerPact Circuit Breaker)

Standard 1-pole and 2-pole I-Line circuit breakers are ordered by designating the required phase connection letters as a suffix to the circuit breaker catalog number. 3-pole circuit breakers do not require this phase designation and are supplied with an “ABC” phase jaw configuration as standard. In most applications this is acceptable since the phase loading is evenly distributed. In applications where the phases must be reversed it is possible to order a “CBA” jaw configuration by simply placing the letters “CBA” at the end of the standard catalog number, e.g., FA36100 becomes FA36100CBA.

Control Wire Tap Lugs

Control wire tap lugs are used in applications requiring connection to a small wire (22-14 AWG) for control circuits. This is accomplished by crimping the wire to a standard wire crimp terminal (not included) and fastening the terminal to the circuit breaker lug. On LA lugs, the lug is drilled to accept a 6-32 screw (included) to secure the crimp connector. On FA lugs, a flat slip-on crimp connector is used to attach to a shim-like connector placed under the circuit breaker lug.

Note: To order as a factory-installed device on FA, FH, FI, KI, Q4, LA, LH, LC, LI, LXI, LX or LC circuit breakers, add suffix number 8041 to circuit breaker catalog number, e.g., KIL362258041. To order as a factory-installed device on MG, MJ, PG, PJ, PL, RG, RJ and RL use the product selector or the respective PowerPact catalog. Tapped lugs will be installed on the “ON” and “OFF” ends of the circuit breaker.

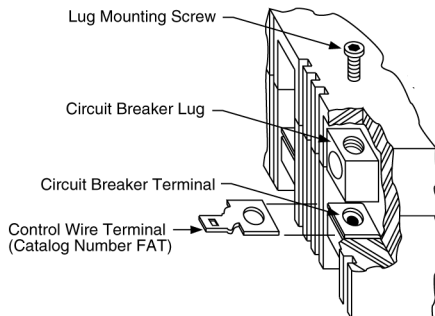
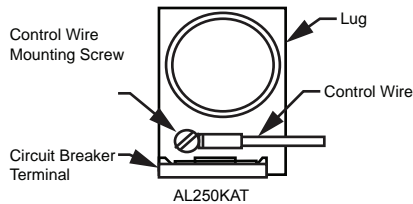

Installing AL250KAT

Table 3.40: Control Wire Terminations for Circuit Breakers

Circuit Breaker	Control Wire Termination Kits	
	Cat. No.	Standard Package Quantity
FA, FH	FAT [1]	1
Q4, LA, LH	AL400LAT	1

Table 3.41: Tapped Lugs for PowerPact™ Circuit Breakers

Circuit Breaker	Amperes Max.	Kit Cat. No.	Standard Package Qty.
MG, MJ, PG, PJ, PL	800 A	AL800M23TK	3
		AL800P6TK	3
PG, PJ, PL	800 A	AL800M23TK4	4
		AL800P6TK4	4
	1200 A	AL1200P24TK	1
		AL1200P25TK	3
RG, RJ, RL	1200 A	AL1200P25TK4	4
		AL1200R53TK [2]	1

[1] Use fully-insulated 0.250 inch slip-on connectors.
[2] I-Line Only.

Special Magnetic or Thermal Calibration
Magnetic

The magnetic trip ranges for standard circuit breakers are listed in the Square D Digest. Requirements outside this range are best accommodated by selecting another standard circuit breaker. In some cases where this is not practical, a circuit breaker may be ordered with special magnetic calibration. Special magnetic calibration is not possible in all cases. Circuit breakers with special magnetic calibration and an **adjustable** magnetic trip range are **not** UL Listed; those with a **fixed** magnetic trip setting are UL Listed. Consult Schneider Electric local sales office for more information.

50 Degrees C

UL 489 Listed molded case circuit breakers are calibrated for 40° C ambient temperature. To meet requirements of higher ambient conditions, circuit breakers can be factory calibrated for a 50° C ambient temperature. Circuit breakers with special thermal calibration are not UL Listed. To order 50° calibration, add “35” suffix to FA/FH/LA/LH or CA to H or J thermal magnetic circuit breaker. Consult local sales office for more information.

Rear-Connected Studs

Rear-connected studs are designed to allow rear termination in applications such as control panels where wire gutter space may be limited. The studs may be bolted directly to the bus or lugs may be attached to the studs.

NOTE: Long and short studs must be alternated on adjacent poles to assure proper electrical clearance

Table 3.42: Rear-Connected Studs—Not UL Listed

Circuit Breaker Cat. No. Prefix	Ampere Ratings	Stud Cat. No.	Dimensions			
			Overall Length	To Back of Circuit Breaker	Diameter	Threads/Inch
FAL, FHL	15–100 A	FAS20	2-1/4 in.	2 in.	3/8 in.	16
FAL, FHL	15–100 A	FAS42	4-7/8 in.	4-1/4 in.	3/8 in.	16
LAL, LHL	125–400 A	LAS54	6-3/16 in.	5-1/2 in.	3/4 in.	16
LAL, LHL	125–400 A	LAS114	12-3/16 in.	11-1/2 in.	3/4 in.	16

NOTE: Use alternate size studs on adjacent poles to obtain proper electrical clearance.



Rear-Connected Studs

Visi-Blade™ Circuit Breakers

Visi-blade construction is a modification to the cover of a thermal-magnetic circuit breaker, a molded case switch, or a Mag-Gard™ circuit breaker which provides a “window” through which the position of the movable contacts can be verified. Luminescent paint is applied to the movable contact arms to clearly indicate their position. Gases produced during high level interruption may cause clouding of the Visi-blade window. Visi-Blade circuit breakers listed below are UL Listed except for FH circuit breakers. Visi-Blade construction is not available on circuit breakers not included in table below.

Add suffix letter “V” to the circuit breaker catalog number, i.e., FAL 36100V.

Table 3.43: Available Visi-Blade Circuit Breakers

Circuit Breaker Prefix	Amperes
FA, FH [3][4]	15–100 A
LA, LH	125–400 A



Visi-Blade Circuit Breaker

Moisture and Fungus Resistant Treatment for Circuit Breakers

This treatment covers the application of moisture and fungus resistant varnish to circuit breakers and molded case switches.

- The varnish meets Military Specification MIL-V-173C VARNISH, MOISTURE AND FUNGUS RESISTANT.
- The treatment meets military Specification MIL-T-152E TREATMENT, MOISTURE AND FUNGUS-RESISTANT, OF COMMUNICATIONS, ELECTRONIC, AND ASSOCIATED ELECTRICAL EQUIPMENT.

The treatment of circuit breakers in accordance with said specifications is intended to protect them against the moisture and fungus condition encountered in service by retarding the absorption of moisture and inhibiting the growth of fungi.

To order for F- and L-frame circuit breakers, place the suffix “FT” at the end of the circuit breaker catalog number, e.g., FAL36100 becomes FAL36100FT. To order for QB, QD, and QG circuit breakers, place the suffix “YF” at the end of the circuit breaker catalog number, e.g., QDL32150 becomes QDL32150YF. ED, EG, EF, GJL, PowerPact™ D-, H-, J-, M-, P- and R-frame circuit breakers are inherently fungus resistant and need no further treatment.

3 MOLDED CASE CIRCUIT BREAKERS AND ENCLOSURES

[3] FH circuit breaker is not UL Listed.
[4] Not available on 1P FA/FH circuit breakers.

Short Handle for LA/LH Circuit Breakers

Certain applications of the LA/LH circuit breakers (as mains in particular panelboards) require the use of a slightly shorter operating handle. For ordering information refer to the chart below.

Table 3.44: Catalog Numbers for Short Handle LA/LH Circuit Breakers

Lug Configuration Desired		Catalog "Prefix Indication"	Catalog "Suffix Indication"	Circuit Breaker Cat. No.
ON End	OFF End			
Lugs	Lugs	"L"	"MB"	LAL36400MB
No Lugs	Lugs	"P"	"MB"	LAP36400MB
Lugs	No Lugs	"P"	"MT"	LAP36400MT
No Lugs	No Lugs	"F"	"MB"	LAF36400MB

Lug Deletion

In some applications, the circuit breaker does not require lugs on one or both ends. To meet this requirement, the circuit breaker should be ordered with the desired lug configuration as indicated below. If necessary, lugs may be removed in the field. However, if lugs are removed in the field, circuit breaker **Types** FH, FC, Q4 LA and LH must be secured with pan-mounting screws, or have "P" screws (cover screws and nuts) installed securing the base to the cover.

Table 3.45: Lug Configuration [5]

ON End	OFF End	Circuit Breaker Prefix – Suffix
Lugs	Lugs	"L" (e.g., FAL36100)
No Lugs	No Lugs	"F" (e.g., FAF36100)
No Lugs	Lugs	"P" (e.g., FAP36100)
Lugs	No Lugs	"P – MT" [6] (e.g., FAP36100MT)

Termination Insert Kits

The standard lugs supplied with EDB, EGB, EJB, and FJA circuit breakers and molded case switches are secured by means of a screw fastened through the circuit breaker terminal into the lug body. If the standard lug is removed and a bolted connection to the circuit breaker terminal pad is desired, a threaded insert kit is required. The insert is installed below the terminal pad. For ordering information see chart below.

Table 3.46: Termination Kit Inserts

Kit Cat. No.	Inserts Per Kit	Circuit Breakers
TIKFD	3	EDB, EGB, EJB, FJA

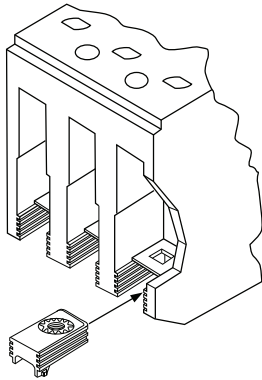

EDB, EGB,
EJB, FJA

Electric Joint Compound

I-Line™ circuit breakers, I-Line busway plug-on units, I-Line panelboards and switchboards, QMB plug-on switches and motor control center plug-on units are supplied with factory applied joint compound on the plug-on connectors. The compound should not be removed because it contributes to the overall performance of the connection. Whenever one of these units is removed and reinstalled, the joint compound should be reapplied. Catalog number PJC 7201 is a two-ounce container of compound specially formulated for the I-Line, QMB and motor control center connections. No other type of commercially available joint compound should be used.

Table 3.47: Electric Joint Compound

Use With	Cat. No.
I-Line Circuit Breakers, QMB Plug-On Units, or Model-V MCC Units	PJC7201
SED Drawout Circuit Breakers	PJC8311



Joint Compound

[5] See information on termination kits below
 [6] MT suffix also required (except for PowerPact™).

Circuit Breakers for Grounded B-Phase (BØ) (Corner-Grounded Delta) Systems

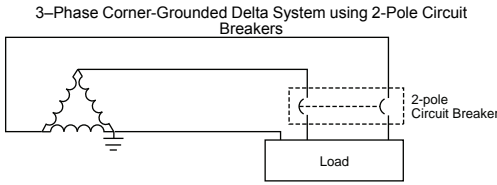

- For use on 480 V systems, FH and LH type circuit breakers must be ordered as 600 V versions and with a 5861 suffix (i.e. FHL361005861).
- For use on 240 V systems, FH type circuit breakers may be ordered as 480 V versions with a 5861 suffix (i.e. FHL341005861).
- FA and LA type circuit breakers are not available with grounded B phase markings.
- Two-pole 240 V grounded B-phase circuit breakers (except EDB, EGB, EJB, QB, QD, QG, QJ, BD, BG, and BJ) will be built using three-pole modules.
- Two-pole grounded BØ circuit breakers will be labeled with 240 Vac interrupting ratings.
- No self-certification is available for interrupting ratings greater than shown in the tables below.

Table 3.48: Application Data for 240 Vac 3Ø Corner-Grounded Delta System

Cat. No. Prefix	Poles	UL Listed Interrupting Rating	
		Ampere Rating	240 Vac Interrupting Rating
QO-H, QOB-H	2	15–100 A	5 kA
QB, QD, QG, QJ	2 [7]	70–250 A	10 kA
EDB, EGB, EJB	2 [7]	15–125 A	18 kA, 35 kA, 65 kA
BD, BG, BJ	2 [7]	15–125 A	18 kA, 35 kA, 65 kA
HD, HG	2 [7]	15–150 A	42 kA
HJ, HL	2 [8]	15–150 A	65 kA, 100 kA
JD, JG, JJ, JL	2 [8]	150–250 A	42 kA, 65 kA, 100 kA
FH, FHL	2 [8]	15–100 A	42 kA
LH, LHL	2 [8]	125–400 A	30 kA
MG, MJ Electronic Trip Unit	2 [8][9]	300–800 A	65 kA
PG, PJ, PK, PL Electronic Trip Unit	2 [8][9]	600–1200 A	65 kA
RG, RK Electronic Trip Unit	2 [8][9]	1200–2500 A	35 kA, 65 kA
RJ Electronic Trip Unit	2 [8][9]	1200–2500 A	100 kA
RL Electronic Trip Unit	2 [8][9]	1200–2500 A	100 kA

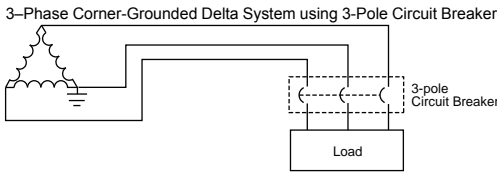

NOTE: Three-pole circuit breakers may be used on three-phase corner-grounded delta systems. The outside poles are to be connected to the ungrounded phase and the grounded conductor connected to the center pole. Connecting the circuit breaker in a manner other than that described or shown may result in an unsafe application of the circuit breaker.

Table 3.49: 480 Vac 3Ø Corner-Grounded Delta System [10]

Cat. No. Prefix	Poles [11]	UL Listed Interrupting Rating [11]	
		Ampere Rating	480 Vac 3Ø Interrupting Rating
HD, HG, HJ, HL	3	15–150 A	18 kA, 35 kA, 65 kA, 100 kA
JD, JG, JJ, JL	3	150–250 A	
FH, FHL	3	15–100 A	10 kA
LH, LHL	3	125–400 A	14 kA
LD, LG, LJ, LL Electronic Trip Unit	3	250–600 A	18 kA, 35 kA, 65 kA, 100 kA
MG, MJ Electronic Trip Unit	3 [9]	300–800 A	35 kA
PG, PK Electronic Trip Unit	3 [9]	600–1200 A	35 kA, 50 kA
PG, PK Micrologic Trip Unit	3 [9]	250–1200 A	
PJ, PL Electronic Trip Unit	3 [9]	600–1200 A	65 kA, 100 kA
PJ, PL Micrologic Trip Unit	3 [9]	250–1200 A	
RG, RJ, RK RL Electronic Trip Unit	3 [9]	1200–2500 A	35 kA, 65 kA, 65 kA, 100 kA
RG, RJ, RK, RL Micrologic Trip Unit	3 [9]	600–2500 A	
NT	3	800–1200 A	100 kA
NW	3	800–6000 A	150 kA

[7] Standard labeling includes grounded B phase.
 [8] Built using 3P module.
 [9] Electronic = ET1.0 Electronic Trip System
 Micrologic = 3.0, 5.0, 3.0A, 5.0A, 6.0A, 5.0P, 6.0P, 5.0H and 6.0 H Micrologic Trip System.
 [10] Refer to NEC 240.85 for application guidance.
 [11] The grounded phase must be connected through the center pole only.

UL Marine Listed/CSA Certified Circuit Breakers (UL 489 Supplement SA)

PowerPact H and J circuit breakers with thermal magnetic trip units meet the UL 489 SA requirements on vessels of any length under or over 65 ft. (19.8m). PowerPact H, J, and L circuit breakers with Micrologic trip units meet the UL 489 Supplement SA requirements for use on vessels over 65 ft. (19.8m) in length. Marine circuit breakers must not use aluminum or aluminum alloys for terminal connections and must be calibrated at an ambient temperature of 104°F (40°C). Standard circuit breakers should not be specified or used in place of marine rated circuit breakers.



For use on vessels over 65 ft. (19.8 m) in length.

Circuit breakers can be ordered with the Marine SA listing by adding the suffix "YA" (marine) to the catalog number.

Table 3.50: Circuit Breakers for Marine Applications

Cat. No. Prefix	Poles	Ampere Rating	Application	Cat. No.
FA, FAL	2	15–100 A	For use only on vessels over 65 feet (19.8 m) in length.	Add the number "9" after the catalog number prefix of the standard circuit breaker catalog number. Example: Standard FAL36100 Marine FAL936100
	3	15–100 A		
FH, FHL	2, 3	15–100 A		
LA, LAL	2, 3	125–400 A		
LH, LHL	2, 3	125–400 A		
PowerPact™ HD, HG, HJ, HL [12]	2, 3	15–150 A	For use on vessels over and under 65 feet (19.8 m) in length.	Add suffix "YA" after the standard circuit breaker catalog number. Example: Standard HGL36100 Marine HGL36100YA
PowerPact JD, JG, JJ, JL [12]	2, 3	150–250 A		
PowerPact HD, HG, HJ, HL, HR [13]	2, 3	15–150 A	For use on vessels over 65 feet (19.8m) in length.	
PowerPact JD, JG, JJ, JL, JR [13]	2, 3	150–250 A		
PowerPact LD, LG, LJ, LL, LR	3, 4	250–600 A		
PowerPact MG, MJ	2, 3	300–800 A	For use only on vessels over 65 feet (19.8 m) in length.	
PowerPact PG, PJ, PL	2, 3, 4	100–1200 A		
PowerPact RG, RJ, RL	2, 3, 4	600–2500 A		

UL Naval Listed/CSA Certified Circuit Breakers (UL 489 Supplement SB)

PowerPact H, J, and L circuit breakers with Micrologic trip units meet the UL 489 Supplement SB requirements for naval vessels. These circuit breakers are subject to various vibration testing as described in UL 489 Supplement SB. Naval circuit breakers must not use aluminum or aluminum alloys for terminal connections and are calibrated at an ambient temperature of 122°F (50°C). Standard circuit breakers should not be specified or used in the place of naval rated circuit breakers.

Circuit breakers can be ordered with the Naval SB listing by adding the suffix "YA1" (naval) to the catalog number.

Table 3.51: Circuit Breakers for Navel Applications

Cat. No. Prefix	Poles	Ampere Rating	Application	Cat. No.
HD, HG, HJ, HL [14]	2, 3	15–150 A	For use on non-combat and auxiliary navalships of any length.	Add suffix "YA1" after the standard circuit breaker catalog number. Example: Standard HGL36100 Marine HGL36100YA1
JD, JG, JJ, JL [14]	2, 3	150–250 A		
LD, LG, LH, LL	3, 4	250–600 A		



[12] Thermal-Magnetic trip units only.

[13] Micrologic trip units only.

[14] With Micrologic trip units only thermal-magnetic circuit breakers not approved.

Electrical Accessories

Table 3.52: Electrical Accessories

Accessory	Description	Rated Voltage	G-Frame Field-Installable Cat. No.	
<p>Auxiliary and Alarm Switches (OF, SD, SDE)</p>  <p>G-Frame</p>	<p>Provides circuit breaker contact status. NOTE: The location of the accessory in the circuit breaker determines its function.</p>	Standard Min Load = 10mA with 24V	1 auxiliary switch (OF) 1a1b AAC	
		2 auxiliary switch (OF) 2a2b —		
		3 auxiliary switch (OF) 3a3b —		
		Alarm Switch (SD) 1a1b AAC		
		Overcurrent Trip Switch (SDE) 1a1b —		
		Consisting of:	OF Switch SDE Adapter —	
		Alarm Switch and Overcurrent Trip Switch —		
		Consisting of:	OF Switch SDE Adapter —	
		Auxiliary Switch/Alarm Switch/Adapter (OF/SD/SDE) Kit —		
		Low Level Min Load = 1mA with 24V	One auxiliary switch (OF) 1a1b —	
		Two auxiliary switches (OF) 2a2b —		
		3 auxiliary switches (OF) 3a3b —		
		Alarm Switch (SD) 1a1b —		
		Overcurrent Trip Switch (SDE) 1a1b —		
		Consisting of:	OF Switch SDE Adapter —	
Alarm Switch and Overcurrent Trip Switch —				
Consisting of:	OF Switch SDE Adapter [1] —			
<p>Shunt Trip (MX)</p>  <p>G-Frame</p>	<p>Trips the circuit breaker from a remote location by means of a trip coil energized from a separate supply voltage circuit.</p>	AC	24 —	
			48 —	
			120 GSA	
			110/130 —	
			208 GSB	
			240 GSC	
			200/250 —	
			277 GSD	
			208/277 —	
			480 GSH	
			380/480 —	
			525/600 —	
			DC	12 —
				24 GSO
				30 —
48 GSP				
60 —				
125 GSR				
250 GSS				
<p>Undervoltage Trip</p>  <p>G-Frame</p>	<p>Instantaneously opens the circuit breaker when the undervoltage trip supply voltage drops to a value between 35% and 70% of its rated voltage. Closing is allowed when the supply voltage of the undervoltage trip reaches 85% of rated voltage.</p>	AC	24 —	
			48 —	
			120 GUA	
			110/130 —	
			208 GUB	
			240 GUC	
			200/250 —	
			277 GUD	
			208/277 —	
			480 GUH	
			380/480 —	
			525/600 —	
			DC	12 —
				24 GUO
				30 —
48 GUP				
60 —				
125 GUR				
250 GUS				

3 MOLDED CASE CIRCUIT BREAKERS AND ENCLOSURES

[1] SDE Adapter used for H- and J-frame only.

Factory-Installed Electrical Accessories

Electrical accessories are available on all molded case circuit breakers except FY and QOM1 circuit breakers.

- Alarm switch is the only accessory available for the 1-pole FA circuit breaker.
- Combination accessories may be ordered by description, i.e., 1021 and 1212.
- All AC electrical accessories shown below are rated for 50/60 Hz.
- See page 3-21 for field-installable accessories. See Digest Section 7 for PowerPact™ circuit breaker accessories.

Table 3.53: Factory-Installed Accessories for Thermal-Magnetic Circuit Breakers

Accessory	Description	Rated Voltage	Coil Burden [2]	Suffix
Shunt Trip	Trips the circuit breaker from a remote location by means of a trip coil energized from a separate circuit. A 120 V shunt trip will operate at 55% or more of rated voltage. All other shunt trips will operate at 75% or more of rated voltage. Application • For use with momentary or maintained push button • Sure Trip Capacitor Unit requires 48 Vdc shunt trip • Leads: (2) Black, 18 AWG Cu	24 Vac	21 VA	-1042 [3]
		120 Vac	24 VA	-1021 [4]
		208 Vac	107 VA	-1021
		240 Vac	154 VA	-1021
		277 Vac	14 VA	-1037 [3]
		480 Vac	45 VA	-1037 [3]
		24 Vdc	36 VA	-1027
		48 Vdc	36 VA	-1028
		125 Vdc	44 VA	-1029
250 Vdc	15 VA	-1030 [5]		
Ground-Fault Shunt Trip	Trips the circuit breaker electrically using the signal from a Micrologic™ Ground-Fault Module. Application • For use only with obsolete GP Ground-Censor™ system or add on ground-fault module • Leads: (2) Orange 18 AWG Cu	—	—	-G [5]
Undervoltage Trip (UVR)	Trips the circuit breaker electrically when a control circuit falls below 35 to 70% of nominal (not field adjustable). Picks up at 35–85% of nominal voltage. Application • UVR must be energized in order to close the circuit breaker • Leads: (2) Brown 18 AWG Cu leads	24 Vac 120 Vac 240 Vac 24 Vdc 48 Vdc	5 VA 8 VA 8 VA 2 VA 3 VA	-1143 [5] -1121 -1124 -1127 -1128
Time Delay Unit	Provides adjustable time delay for UVR of 0.1 to 0.6 second before circuit breaker trips. Application • For use only with -1121 UV trip • Adjustable time delay (0.1 to 0.6 second) • I-Line unit requires 1.5 in. (38 mm) of mounting space • Leads: (2) Brown 18 AWG Cu and (2) Black/White 18 AWG Cu	120 Vac	Cat. No.	
			690UVTD	690UVTDI
Auxiliary Switches	Monitors circuit breaker contact status and provides a remote signal indicating the circuit breaker contacts are OPEN or CLOSED. Application • Max. Load = FA, FH, FI, LC, LE, LI, LX, LXI 10 A @ 125–250 Vac, ¼ hp @ 125–250 Vac, 5 A @ 30 Vdc • Leads: Yellow for "A", Blue for "B", Striped for common 18 AWG Cu	1A/1B	See load info. in App. text at left	-1212
		2A/2B		-1352
		3A/3B		-1364 [6]
Alarm Switches	Used with control circuits and actuated only when the circuit breaker has tripped. Standard construction includes a normally-open contact. Application • Max. Load = 10 A @ 125–250 Vac • Max. Load = 15 A @ 30 Vdc • Leads: (2) Red 18 AWG Cu	1A 1A 1B 1B	250 Vac 28 Vdc 250 Vac 48 Vdc	See load info. in App. text at left -2100 -2100 -2103 -2103

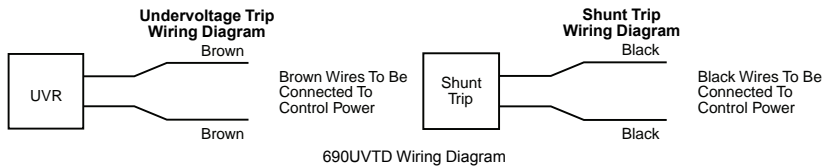
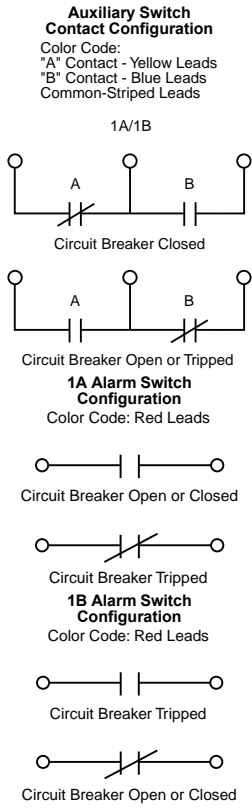

[2] Coil burden values do not apply to LC, LE, LI, LX and LXI. Consult Field Sales office for more information.

[3] Not available on FI or KI circuit breakers.

[4] LC, LE, LI, LX, and LXI circuit breakers operate at 75% or more of rated voltage.

[5] Not available on LC, LE, LI, LX, LXI circuit breakers.

[6] Not available in FA, FC, FH, FI and KI circuit breakers.

Field-Installable Electrical Accessories

Complete field-installable accessory catalog number by inserting suffix from page 3-20 between the parentheses in the catalog numbers shown in the table below. (Example: LA11212)

Table 3.54: Field-Installable Accessories for Thermal-Magnetic and Electronic Trip Circuit Breakers

Circuit Breaker	Shunt Trip	Ground-Fault Shunt Trip [7]	Undervoltage Trip	Auxiliary Switches	Alarm Switch
Miniature Circuit Breakers EH and EH-PL	Factory-Installed Only	Not Available	Not Available	Factory-Installed Only	Factory-Installed Only
FA, FH	Factory-Installed Only	Factory-Installed Only	Factory-Installed Only	Factory-Installed Only	Factory-Installed Only
LA, LH Series 4 [8]	LA1()	LA1G	LA1 ()	LA1 ()	Factory-Installed Only Right Pole
Q4	LA1()	LA1G	LA1 ()	LA1 ()	Factory-Installed Only Right Pole

Table 3.55: Accessory Mounting Locations

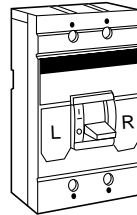

LA, LH, Q4 Series 4 circuit breakers or newer = Field-installable accessories
LC, LI, LX, LXI circuit breakers = Field-installable accessories
Both accessory ports will accept shunt trips, UVRs and auxiliary switches. Alarm switches are factory installable **only** (right pole). Maximum of one device per port.

Auxiliary Switch Contact Configuration
Color Code:
"A" Contact - Yellow Leads
"B" Contact - Blue Leads
Common-Striped Leads

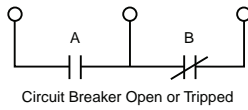
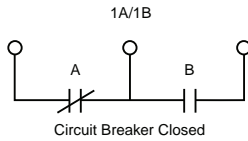

1A Alarm Switch Configuration
Color Code: Red Leads

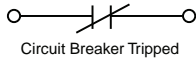

1B Alarm Switch Configuration
Color Code: Red Leads



Undervoltage Trip Wiring Diagram

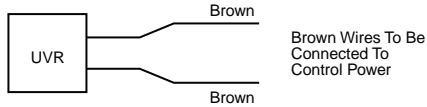

Shunt Trip Wiring Diagram

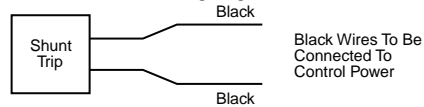

[7] Used with obsolete GP Ground-Censor™ system or add-on ground-fault modules.
[8] With LA and LH top-feed circuit breakers (suffix MT, I-Line jaws on OFF end) all accessories must be factory installed.



KAMO2120AC
with KIL Circuit Breaker



FAMO1 and FAMOP
with FAL Circuit Breaker

Electrical Operators

Provides remote ON, OFF/RESET control of molded case circuit breakers.

- A complete line of field-installable electrical operators.
- Installing side mounted motor operators on non I-Line™ circuit breakers requires the use of a separate mounting pan.
- Side mounted electrical operators require an additional 4-1/2 in. (114 mm) of mounting space in I-Line installations.

When remote indication of circuit breaker status is required, order circuit breaker with 1A-1B auxiliary switch for ON-OFF Indication and alarm switch for TRIP Indication. Electrical operators require SPDT maintained contact switch. Refer to Class 9001 control unit listing for operators and pilot lights.

NOTE: Not available on Mag-Gard™ circuit breakers and molded case switches.

Table 3.56: Electrical Operators

Circuit Breaker Prefix	Top Mount		Side Mount		Mounting Pan Cat. No.
	Voltage	Cat. No.	Voltage	Cat. No.	
FA, FH	—	—	120 Vac	FAMO1	—
FAL, FHL	—	—	120 Vac	FAMO1	FAMOP
LA, LH, Q4	—	—	120 Vac	LAMO1	—
LAL, LHL, Q4L	120 Vac	LAMO2120AC	120 Vac	LAMO1	LAMOP
	240 Vac	LAMO2240AC			
	24 Vdc	LAMO224DC			
	125 Vdc	LAMO2125DC			

Handle Accessories

Table 3.57: Handle Accessories

Circuit Breaker Prefix	Poles	Cat. No.
Handle Tie		
(2) FA	3	FKHT
2 LA or 2 Q4	2, 3	LAHT
California Title 24 Comb. Handle Tie and Lock Off		
FY	(3) 1P	FY3HT
FA	(3) 1P	FA3HT
Handle Extension		
Q4	2, 3	AHEXLI
Handle Padlock Attachment (locks ON or OFF)		
FY Series 1	1	HPAFYQ
FA, FH	1, 2, 3	HPAFK
FY Series 2	2, 3	HPAFK
LA, LH, Q4	2, 3	HPALM HPAXLM

Interlocks

Table 3.58: Walking Beam Mechanical Interlock Components [9]

Circuit Breaker Prefix	Operator Suffix	Manually Operated		Electrically Operated		
		Walking Beam Ass'y.	Mounting Pan	Operator Suffix	Walking Beam Ass'y.	Mounting Pan
		Cat. No.	Cat. No.		Cat. No.	Cat. No.
FAL, FHL	WB	FA4WB	FAWBP4	WBMO	FA9WB	FAWBP9
LAL, LHL	WB	LA6WB	LAWBP6	WBMO	LA10WB	LAWBP10



Walking Beam Mechanical Interlock
Requires 2 circuit breakers with WB suffix,
1 walking beam assembly and 1 mounting pan.

3 MOLDED CASE CIRCUIT BREAKERS AND ENCLOSURES

[9] Fully enclosed interlocked units are available in Type 1 and Type 3R enclosures, with two neutrals provided in each enclosure. The completely enclosed assembly is not UL Listed. Please consult your nearest Schneider Electric sales office for more information.

Locks, Installation Accessories, and Rear Connections

Table 3.59: Locks, Interlocking

Device	Description	G-Frame Field-Installable Cat. No.
Handle Padlocking Device	Removable (lock OFF only)	AHP
	Fixed (lock OFF or ON)	—
	Fixed (lock OFF only)	—
Interlocking (Not UL listed)	Mechanical for circuit breakers with rotary handles	—
	Mechanical for circuit breakers with toggles	—
Key Locking	Ronis	—
	Profalux	—

Provision and 2 locks keyed alike

Table 3.60: Installation Accessories for G- and D-Frame Circuit Breakers

Description	G-Frame Field-Installable Cat. No.
Front Panel Escutcheon for Toggle Circuit Breakers	—
Front Panel Escutcheon for Rotary Handle, Motor Operator, or extended escutcheon	—
Phase Barriers (set of 6)	—
Handle Rubber Boot	—
Sealing Accessories	ACS
DIN rail adapter	GYR
Toggle Extensions (set of 10)	—

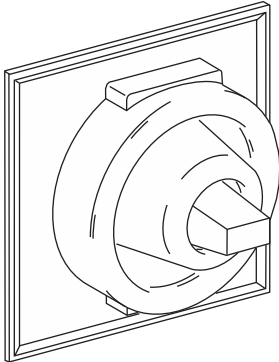
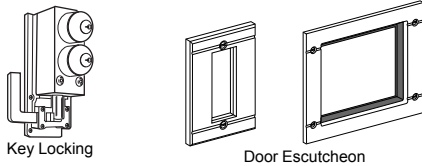

Hard Rubber Boot

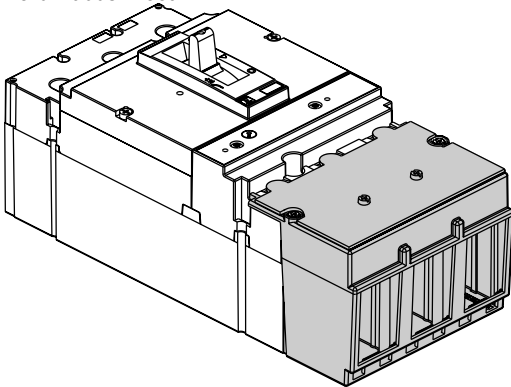

Terminal Covers

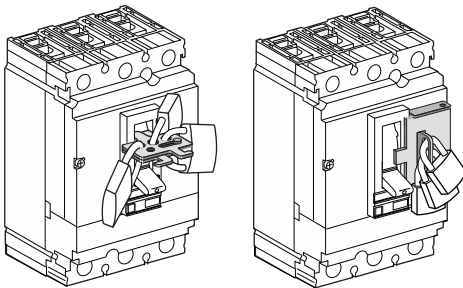

Removable Padlock Attachment Fixed Padlock Attachment

Cylinder Lock

Used to lock the circuit breaker in the OFF position. Circuit breaker cannot be reset when locked OFF.

Table 3.61: Cylinder Lock

Circuit Breaker Prefix	Factory Installed Suffix	Field-Installable Cat. No.
FA, FAL, FH, FHL [10]	—CL	Factory-installed only
LA, LAL, LH, LHL, Q4	Field-installable only	LA1CL

Miscellaneous Accessories

Table 3.62: Terminal Shields and Phase Barriers

Used With	Description	Cat. No.	Qty Per Kit
G-Frame	Terminal Shield (3P)	GYT	1

[10] Not available on Mag-Gard circuit breakers and molded case switches.

Mechanical Lug Kits

Table 3.63: Mechanical Lug Kit Information

Circuit Breaker Application				(Number of Wires Per Lug) Wire Range [11]	Cat. No.	Lugs Per Kit
Standard	Ampere Rating	Optional	Ampere Rating			
Al Lugs for Use with Al or Cu Wire						
FA, FH	15–30 A	FA, FH	35–100 A	(1) 14–4 AWG Cu or (1) 12–4 AWG Al	AL50FA	3
FC	35–100 A	FC	15–30 A	(1) 14–3 AWG Cu or (1) 12–1 AWG Al	AL100FA4	3
FA, FH	35–100 A	FA, FH	15–30 A	(1) 14–1/0 AWG Cu or (1) 12–1/0 AWG Al	AL100FA	3
—	—	FA, FH, FC	15–100 A	(1) 12–3 AWG Cu	AL100TF [12]	3
—	—	FA	150 A (only)	(1) 2–3/0 AWG	AL150FA	3
Q4, LA, LH	125–400 A	—	—	(1) 1 AWG–600 kcmil or (2) 1 AWG–250 kcmil	AL400LA	1
—	—	Q4, LA, LH	125–400 A	(1) 350–750 kcmil	AL400LH7	1
Cu Lugs for Use with Cu Wire Only [13]						
FC	15–30 A	—	—	(1) 14–10 AWG Cu	CU30FA4	3
—	—	FA, FH, FC	15–100 A	(1) 12–3 AWG Cu	CU100TF [12]	3
—	—	FA, FH, FC	15–100 A	(1) 14–1 AWG Cu	CU100FA	3
—	—	Q4, LA, LH	125–400 A	(1) 1 AWG–600 kcmil Cu or (2) 1 AWG–250 kcmil Cu	CU400LA	1



AL50FA



AL100FA



AL250KA



AL400LA



AL600LI5



AL400LH7

[11] Unless otherwise specified, wire sizes apply to both aluminum and copper conductors.

[12] For use in the OFF end only, when the OFF end is the load end.

[13] Use suffix 8002 for factory-installed Cu lugs.

Compression Lug Kits

Table 3.64: Field-installable Compression Lug Kits [14]

Circuit Breaker Type	Wire Range [15]	Dimension A (In)	Max. Lugs Per Terminal	Cat. No.	Lug Qty. Per Kit
Aluminum Compression Lug Kits					
FA, FH, FC	8–1/0 AWG	1.3	1	VC100FA	3
	250–350 kcmil	1.25	2	VC400LA35	2
	4 AWG–300 kcmil	1.0	2	VC400LA3	2
	2/0 AWG–500 kcmil	2.2	1	VC400LA5	1
LA, LH, Q4	500–750 kcmil	2.5	1	VC400LA7	1
	Copper Compression Lug Kits				
FA, FH, FC	6–1/0 AWG Cu	1.4	1	CVC100FA	3
	2/0 AWG–300 kcmil Cu	1.3	2	CVC400LA3	2
	250–500 kcmil Cu	2.3	1	CVC400LA5	1

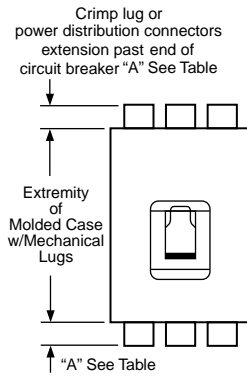

3 MOLDED CASE CIRCUIT BREAKERS AND ENCLOSURES



Power Distribution Connectors (PDC) for Circuit Breakers—for Field Replacement of Mechanical Lugs

Can be used for multiple load connections on one circuit breaker. Use in place of standard distribution blocks to save space and time.

Field-installable kits, including tin-plated aluminum connectors and all necessary mounting hardware are available for Square D FA, LA and Q4-frame molded case circuit breakers.

Connectors are UL Listed:

- For use on load end of circuit breaker only
- For use in UL508 Industrial Control applications only
- For use in UL 1995/CSA C22.2 No. 236 heating and cooling equipment
- For copper wire only



Table 3.65: PDC Lugs

Use With Circuit Breaker [16]	Circuit Breaker Ampere Rating	Wires Per Terminal & Wire Range [17] Cu	Cat. No.	Lug Quantity Per Kit	Dimension A (In.)
FAL, FHL, FCL [18]	15–100 A	(6) 14–6 AWG	PDC6FA6	3	1.0
		(3) 14–2 AWG	PDC3FA2	3	1.2
		(6) 12–2/0 AWG	PDC6LA20	1	2.25
LAL, LHL, Q4L	125–400 A	(12) 14–4 AWG	PDC12LA4	1	1.25
		(3) 14–2 AWG	PDC4LA250	1	2.0
		(1) 2 AWG–250 kcmil			

[14] See instruction bulletins for recommended tools.
 [15] Unless otherwise specified, wire sizes apply to both aluminum and copper conductors.
 [16] Not for use with I-Line circuit breakers.
 [17] When using fine stranded wire, increased cross sectional area may cause maximum wire size to be reduced.
 [18] OFF end only when OFF end is the load end.

S48890 and S48895 Restraint Interface Modules

The Restraint Interface Module (RIM) is used to allow zone-selective Interlocking communications between circuit breakers with Micrologic™ Series B trip units or Micrologic™ #.0x trip units, Compact™ STR53 trip units, Masterpact™ STR58 trip units, Federal Pioneer USRC and USRCM trip units, and Square D GC series ground-fault relays.

Upstream circuit breakers with Micrologic 3.0A, 5.0A 5.0P, 5.0H, 6.0A, 6.0P, and 6.0H trip units can receive up to 15 input signals without requiring a restraint interface module. If the number of input signals exceeds 15, then a RIM is required. Contact your local Sales Office for RIM requirements.

The restraint interface module operates on either 120 Vac/24 Vdc, or 240 Vac/24 Vdc, 50/50 Hz.

NOTE: The maximum distance between devices is 1000 ft. (305 m)

Table 3.66: Restraint Interface Module (RIM)

Cat. No.	Voltage
S48890	120 Vac/24 Vdc
S48895	240 Vac/24 Vdc

Table 3.67: RIM Requirements

Upstream Device (receives input from RIM) Downstream Device (sends output to RIM)	Micrologic #.0x Trip Units	Square D Micrologic Series B Trip Units	Square D GC- 100 Ground- Fault Relay for Equipment Protection	Square DGC-200 Ground-Fault Relay for Equipment Protection	Merlin Gerin STR58 Trip Units	Federal Pioneer USRC and USRCM Trip Units
Micrologic #.0x Trip Units	15	R	R	15	15	R
Square D Micrologic Series B Trip Units	R	26	R	R	R	15
Square D GC-100 Ground-Fault Relay for Equipment Protection	R	R	7	R	R	R
Square D GC-200 Ground-Fault Relay for Equipment Protection	15	R	R	15	15	R
Merlin Gerin STR58 Trip Units	15	R	R	15	15	R
Merlin Gerin STR53 Trip Units	15	R	R	15	15	R
Federal Pioneer USRC and USRCM Trip Units	R	15	R	R	R	15
Square D Add-on Ground-Fault Module for Equipment Protection	R	5	R	R	R	R

R=RIM module is required to restrain any devices.

Numerical References=Maximum number of upstream circuit breakers which can be restrained without requiring a RIM module.

Dimensions and Weights

Table 3.68: Circuit Breakers Dimensions

Circuit Breaker Catalog No. Prefix	No. Poles	Fig. No.	Dimensions—Inches							
			A	B	C	D	E	F	G	H
FAL, FHL	1	21	6.00	1.50	3.16	4.13	0.44	5.13	1.50	—
	2	22	6.00	3.00	3.16	4.13	0.44	5.13	—	—
	3	23	6.00	4.50	3.16	4.13	0.44	5.13	1.50	0.75
GJ	3	32	3.54	4.72	2.76	3.94	2.20	—	—	—
Q4L, LAL, LHL	2, 3	23	11.00	6.00	4.06	5.84	0.88	9.25	2.00	1.00

Table 3.69: Shipping Weights

Frame Size	Approx. Shipping Weight (Lbs.)
FAL FHL 2-pole FCL	3
FAL FHL 3-pole	5
Q4L	15
GJ	3
LAL LHL	15

Figure 21

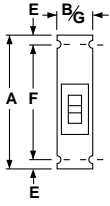

Figure 22

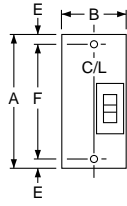

Figure 23

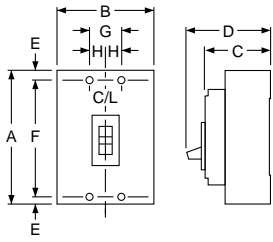

Figure 28

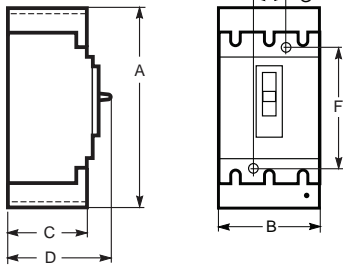
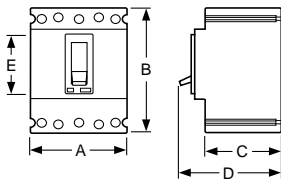

Figure 32



3 MOLDED CASE CIRCUIT BREAKERS AND ENCLOSURES

Enclosed Molded Case Switches

Enclosed molded case switches are UL Listed devices supplied with factory-installed automatic molded case switch. Use the Cat. No. listed below and add the enclosure NEMA type suffix as noted in footnote in Table 3.70. An insulated groundable neutral, if required, must be ordered separately from Digest Section 7. Enclosed molded case switches are manufactured on order only.

Table 3.70: Enclosed Molded Case Switches

System	Ampere Rating	Cat. No. Add Suffix [1]	600 Vac Short Circuit Withstand Ratings
FH—100 A Frame, 3P, 600 Vac Max.			
2P	100	FHE26000()	18 kA
3P	100	FHE36000()	18 kA
LH—400 A Frame, 3P, 600 Vac Max.			
2P	400	LHE26000()	25 kA
3P	400	LHE36000()	25 kA

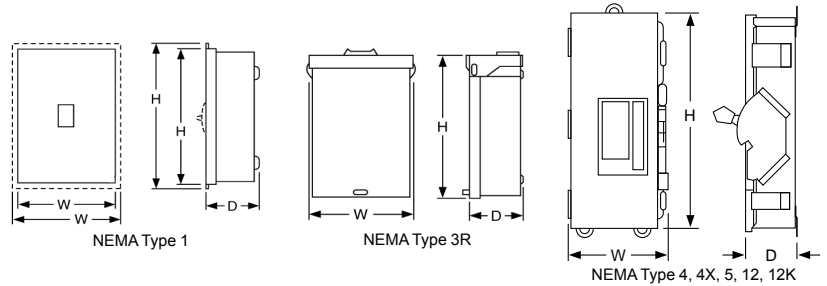

Table 3.71: Enclosed Molded Case Switch Dimensions

Cat. No. Prefix—Suffix	Series	Approximate Dimension					
		H		W		D	
		in.	mm	in.	mm	in.	mm
FHE—AWK	E05	19.50	495	9.13	232	4.88	124
FHE—DS	E05	19.50	495	9.13	232	4.88	124
FHE—F	E02	19.50	495	9.88	251	4.13	105
FHE—RB	E03	18.00	457	8.88	226	4.88	124
FHE—S	E02	18.13	460	8.63	219	4.13	105
LHE—AWK	E05	42.25	1073	13.75	349	7.25	184
LHE—DS	E05	42.25	1073	13.75	349	7.25	184
LHE—F	A03	45.63	1159	16.50	419	6.50	165
LHE—R	A03	44.00	1118	15.38	391	7.88	200
LHE—S	E03	44.50	1130	15.38	391	6.50	165

MOLDED CASE CIRCUIT BREAKERS AND ENCLOSURES

3

[1] Add suffix S or F for NEMA 1 surface mounted or NEMA 1 flush mounted, respectively. Add suffix RB for NEMA 3R with bolt-on hub provision (FHE prefix only) or suffix R for NEMA 3R with a blank top endwall (LHE prefix only), respectively. Add suffix AWK for NEMA 12. Add suffix DS for NEMA 4/4X/5 stainless steel.

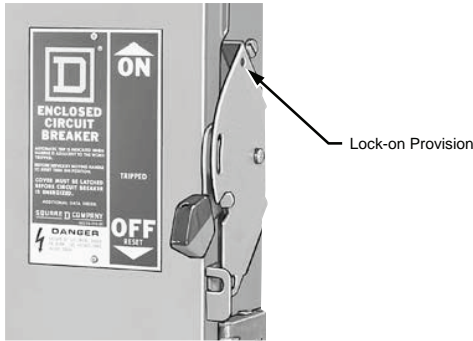

Lock-On Provision

Lock-On Provisions

Lock-off provisions are standard on all NEMA Type 4, 4X, 5 stainless steel and NEMA Type 12, 12K circuit breaker enclosures. Provision for one inch hasp padlock is available factory installed. This modification will allow the circuit breaker to be locked in the ON position. When locked in the ON position, the external operator will not indicate if circuit breaker is tripped. UL Listed.

Table 3.72: Enclosure

Enclosure Prefix	Suffix for Lock-On Provision
FA, J, LA, L, M, P	SPLO

Pilot Light—Selector Switch—Push Button

Pilot lights, push buttons or selector switches are available factory installed in the cover of NEMA Type 4, 4X, 5 stainless steel or NEMA Type 12, 12K circuit breaker enclosures. Wiring to contact blocks is not available. Customer must furnish catalog number of device desired. Price = circuit breaker + enclosure + neutral + ground + pilot light, push button and/or selector switch + factory-installed adder. Order by description. L600 enclosures are UL Listed, other enclosures are not UL Listed.

Phenolic Legend Plate

Available engraved and mounted on most circuit breaker enclosures. Legend engraved in 1/4-inch high white letters on black background. Customer must provide legend. UL Listed. Not available on NEMA Type 7 or 9 enclosures.

To order, add suffix NP to standard catalog number (i.e. LA400SNP).

Stainless Steel Front

The FA100F NEMA Type 1, flush-mount circuit breaker enclosure is available with a stainless steel front. This modification is desirable in food handling areas such as cafeterias and restaurants. Not UL Listed.

Table 3.73: Stainless Steel Front Enclosure

Cat. No.
FA100FSS



Key Interlock Systems

(Factory installed only.)

Interlocks are used to prevent the authorized operator from making an unauthorized operation. Available only on NEMA 4, 4X, 5, 12K, and 12/3R circuit breaker enclosures. The key interlock system is a simple and easy method of applying individual key interlock units and assemblies to the above equipment so as to require operation in a predetermined sequence. UL Listed.

Quoting

Contact local Field Sales office for catalog number, availability and pricing prior to quoting a job.

Ordering

Order cannot be released for production until the following information has been provided:

- End User—Company name, address
- Function of each lock (e.g., circuit breaker to be locked open with key removed, key held when circuit breaker is closed)
- Existing Equipment—if circuit breaker is to be interlocked with equipment already on site, provide brand of existing lock and key number
- Other New Equipment—if circuit breaker is to be interlocked with new equipment not yet installed at the site, then provide contact person and phone number so that locks may be coordinated
- Additional information may be required upon order entry

Diagram Symbols

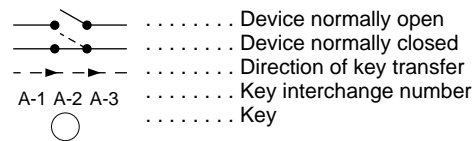

Sample Application—1 (See Figure 1)

To prevent two devices from being closed simultaneously.

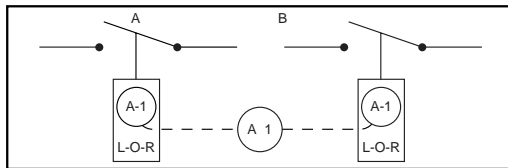

Figure 1

Two devices are shown in Figure 1. In operation they are not closed at the same time. With the interlocks arranged as shown only one key is required in the interlocking system. Both devices are shown open, therefore, the key is free. To close any one device the key is inserted and turned in that particular lock, the key is held in this lock until the device is again locked open. This simple interlocking sequence lends itself to a multitude of applications. The procedure is the same for two devices, neither of which is to be opened at the same time.

Sample Application—2 (See Figure 2)

To prevent opening of switch A when circuit breaker B is closed.

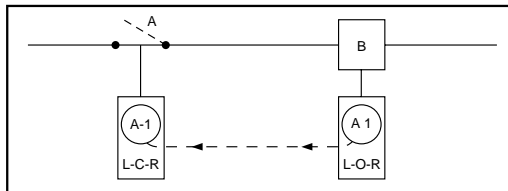

Figure 2

Switch A and circuit breaker B are in closed position. Key A-1 is held in circuit breaker B interlock.

- Open circuit breaker.
- Turn key A-1 in L-O-R interlock on circuit breaker B to lock open. Key A-1 is now free.
- Insert key A-1 in L-C-R interlock on switch A and turn to unlock.
- Open switch A. Key A-1 is now held. Reverse sequence to restore service.

Sample Application—3 (See Figure 3)

To prevent operation of switch A when circuit breaker B is closed. Permits reclosing of circuit breaker for servicing when switch is locked open.

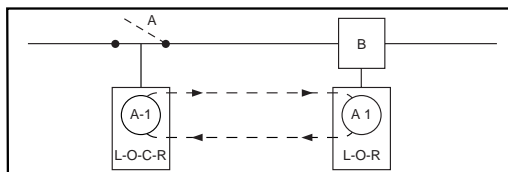

Figure 3

Switch A and circuit breaker B are in closed position. Key A-1 is held in circuit breaker interlock.

- Open circuit breaker.
- Turn key A-1 in L-O-R interlock on circuit breaker B to lock open. Key A-1 is now free.
- Insert key A-1 in L-O-C-R interlock on switch A and turn to unlock.
- Open switch A.
- Turn key A-1 in L-O-C-R interlock on switch A to lock open. Key A-1 is now free.
- Return key A-1 to circuit breaker interlock and unlock for operation during servicing period.

Reverse sequence to restore service.

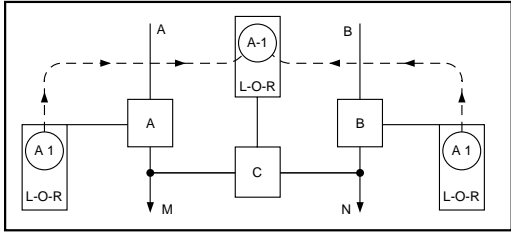

Figure 4

Sample Application—4 (Main-Tie-Main) (See Figure 4)

To prevent paralleling of lines A and B.—Two loads, fed from either source.

Circuit breaker A is closed to supply load M. Circuit breaker B is closed to supply load N. Tie-circuit breaker C is open. Keys A-1 are held in interlocks on both circuit breakers A and B. Tie-circuit breaker C cannot be closed unless either A or B is locked open.

To transfer load N to circuit breaker A, proceed as follows:

- Open circuit breaker B.
- Turn key A-1 in L-O-R interlock on circuit breaker B to lock open. Key A-1 is now free.
- Insert Key A-1 in L-O-R interlock on tie-circuit breaker C and turn to unlock. Key A-1 is now held.
- Close tie-circuit breaker C.

Reverse sequence to restore service.

Load M can be supplied through circuit breaker B in a similar manner.

California Proposition 65 Message

- ⚠ WARNING:** Some of the products listed in this document can expose you to chemicals which are known to the State of California to cause cancer, birth defects, or other reproductive harm.

For more information, go to <https://www.p65warnings.ca.gov/>.