



PrismaSeT P Active

Catalog 2023
Cubicles up to 4000 A

Version 14



se.com

Life Is On

Schneider
Electric



Table of Contents

Index
p. A-2

Index Of Commercial References
> p. A-2

Overview
p. B-1

Promotional
Pages
> p. B-2

EcoStruxure™ Facility
Expert
> p. B-4

PowerLogic™
HeatTag
> p. B-11

Standards and
certifications
p. C-1

Standards and tested switchboards
> p. C-2

Enclosure characteristics
> p. C-7

Selection guide
p. D-1

Select a cubicle
configuration
> p. D-2

Functional units
p. E-1

Circuit breakers
> p. E-2



Switch-disconnectors
> p. E-39



Source-changeover
> p. E-41



Cubicles
p. F-1

Enclosures
> p. F-2



Dimensions
> p. F-7



Enclosures
> p. F-14



Lineryg distribution
systems
p. G-1

Power busbars
> p. G-2



Distribution blocks
> p. G-14



Device feeders
> p. G-16

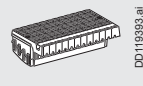

Functionnal
partitioning
p. H-1

Main distribution
> p. H-4

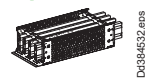

Additional
information
p. I-1

Spare parts
> p. I-4

Electrical characteristics
> p. I-11

After sales tools
p. J-1

Practical information
> p. J-2

Maintenance
> p. J-18

PrismaSeT P Active

Index
p. A-2

A

PrismaSeT G enclosures

> p. B-14

Overview
p. B-1

B

Thermal characteristics
of switchboards > p. C-9

Specific application
> p. C-17

Standards and
certifications
p. C-1

C

Selection guide
p. D-1

D

TransferPacT
> p. E-54

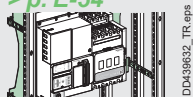

DD439632_TR.eps

Fusegear
> p. E-58



DD383777.eps

Fusegear/Switch-disconnector
> p. E-59



DD119396.ai

Others
> p. E-61

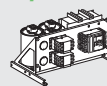

DD385570.eps

Functional units
p. E-1

E

Others
> p. F-23



DD119392.ai

Cubicles
p. F-1

F

Secondary distribution
> p. G-20



DD119394.ai

Terminal blocks and lines
> p. G-35



DD119395.ai

Linergy distribution
systems
p. G-1

G

Functional partitioning
p. H-1

H

Additional information
p. I-1

I

After sales tools
p. J-1

J

Index Of Commercial References With Description

Com. no.	Description	Page
10...		
10387	Comb busbar domae 1P 63 a l = 12 x 18 mm	G-33
10388	Comb busbar 1x10mm ² 57 mod.	G-33
10389	Comb busbar domae 2P 63 a l = 12 x 18 m.	G-33
10390	Comb busbar 2x10mm ² 56 mod.	G-33
10391	Comb busbar 3x10mm ² 12 mod.	G-33
10392	Comb busbar 3x10mm ² 57 mod.	G-33
10393	Comb busbar domae 4P 63 a l = 12 x 18 m.	G-33
10394	Comb busbar 4x10mm ² 56 mod.	G-33
10395	Comb busbar 4x16mm ² 54 mod.	G-33
10396	10 Tooth cover	G-33
10397	Insulated connector for comb busbar 35 mm ²	G-33
10398	Comb busbar side covers	G-33
10399	Comb busbar side covers	G-33
10405	10 Endcover for busbars 4 phases	G-31, G-33
10545	Comb busbar 12 modules C60 clario	G-31
10546	Comb busbar 48 modules C60 clario left	G-31
10547	Comb busbar 48 modules C60 clario right	G-31
13...		
13735	Lot of 10 standard symbols labels	F-22
13736	Lot of 10 special symbols labels	F-22
14...		
14811	1P comb busbar 27mm spacing	G-28
14812	2P comb busbar 27mm spacing	G-28
14813	3P comb busbar 27mm spacing	G-28
14814	4P comb busbar 27mm spacing	G-28
14818	End caps and tooth caps	G-28
14885	4 Insulated connectors	G-28
19...		
19512	Comb busbar ph and n 18poles	G-31
19516	Comb busbar 3P and n 18poles	G-31
21...		
21089	Comb busbar 1P and n 48poles	G-31
21093	Comb busbar 3P and n 48poles	G-31
21094	40 End covers/comb busbar 1P and n	G-31
21095	40 End covers/comb busbar 3P and n	G-31
21096	12 Tooth-caps 3Poles	G-31
21098	4 Connectors 25mm ²	G-31
21501	Comb busbar ph and n 12Poles	G-31
21503	Comb busbar ph and n 24Poles	G-31
21505	Comb busbar 3P and n 12Poles	G-31
21507	Comb busbar 3P and n 24Poles	G-31

Com. no.	Description	Page
29...		
29350	Remote controlled source changeover	E-51
29351	Base plate with mechanical and electrical interlocking	E-51
29504	3 Bimetallic lugs for alu cable 150mm ² A	I-46
29505	4 Bimetallic lugs for alu cable 150mm ² A	I-46
29506	3 Bimetallic lugs for alu cable 185mm ² A	I-46
29507	4 Bimetallic lugs for alu cable 185mm ² A	I-46
31...		
31073	Mechanical interlock (INS250)	E-52
31074	Mechanical interlock (INS320/630)	E-52
31140	Manual sourcechangeover INS250 3P 100 a	E-53
31141	Manual sourcechangeover INS250 4P 100 a	E-53
31142	Manual sourcechangeover INS250 3P 200 a	E-53
31143	Manual sourcechangeover INS250 4P 200 a	E-53
31144	Manual sourcechangeover INS250 3P 160 a	E-53
31145	Manual sourcechangeover INS250 4P 160 a	E-53
31146	Manual sourcechangeover INS250 3P 250 a	E-53
31147	Manual sourcechangeover INS250 4P 250 a	E-53
31148	Manual sourcechangeover INS320 3P 320 a	E-53
31149	Manual sourcechangeover INS320 4P 320 a	E-53
31150	Manual sourcechangeover INS400 3P 400 a	E-53
31151	Manual sourcechangeover INS400 4P 400 a	E-53
31152	Manual sourcechangeover INS500 3P 500 a	E-53
31153	Manual sourcechangeover INS500 4P 500 a	E-53
31154	Manual sourcechangeover INS630 3P 630 a	E-53
31155	Manual sourcechangeover INS630 4P 630 a	E-53
31301	Additional cable lug adapters 3P INS/INV	E-39
31302	Additional cable lug adapters 4P INS/INV	E-39
32...		
32504	3 Bimetallic lugs for alu cable 240mm ²	I-46
32505	4 Bimetallic lugs for alu cable 185mm ²	I-46
32506	3 Bimetallic lugs for alu cable 300mm ²	I-46

Index Of Commercial References With Description

Com. no.	Description	Page
32507	4 Bimetallic lugs for alu cable 300mm ²	I-46
32610	Compact NSX 400 to 630, 48 to 415VAC 50/60Hz	E-51
32611	Base plate with mechanical and electrical interlocking	E-51
33...		
33596	3P arc chute insulating screen	E-15, E-17, E-19
33597	4P arc chute insulating screen	E-15, E-17, E-19
33628	Terminal shield 3P	E-49
33629	Kit 3P vertical connection adapters	E-49
33642	3P cable lug adapter kit	E-10, E-13, E-15, E-19, I-47, I-48
33644	Interlocking kit for 2 breakers with rot	I-47, I-48
33643	4P cable lug adapter kit	E-10, E-15, E-19, I-47, I-48
33645	Connection 3P for NS1600/3200A	I-47, I-48
33644	Interlocking kit for 2 breakers with rot	E-10, E-13, E-15, E-19, E-39
33645	Connection 3P for NS1600/3200A	E-10, E-15, E-19, E-39
33890	Connection 4P for NS1600/3200A	E-49
33975	ComPacT NS1600/NS2500, 3 poles, fixed, 1600A/2500A	E-14, E-39
33976	ComPacT NS1600/NS2500, 4 poles, fixed, 1600A/2500A	E-14, E-39
47...		
47335	Arc chute insulating screen for 3P fixed	E-10, E-11, E-13
47336	Arc chute insulating screen for 4P fixed	E-10, E-11
49860	Distribution connectors, FuPacT ISFT100, 3x16mm ²	E-59
49861	ISFT 100 3P feeding busbar for 2 switche	E-59
49862	ISFT 100 3P feeding busbar for 3 switche	E-59
49863	ISFT 100 3P feeding busbar for 4 switche	E-59
49865	ISFT 100 3P feeding clamp for feeding bu	E-59
A...		
A9N21035	Comb busbar 1P-n 63a 56mod.	G-32
A9N21036	Comb busbar 3P-n repar. 63a 56mod.	G-32
A9N21037	Comb busbar 1P-n Vigi 63a 56mod.	G-32
A9N21038	Comb busbar 3P-n Vigi repar. 63a 56mod.	G-32
A9N21039	Set of 20 end caps 1P-n	G-32
A9N21040	Set of 20 end caps 3P-n	G-32
A9N21041	Set of 10 phase connectors	G-32
A9N21042	Set of 10 neutral connectors	G-32

Com. no.	Description	Page
A9N21050	Set of 10 tooth caps	G-32
A9XAH157	Acti 9 comb busbar AUX1P 100A 57 modules	G-29
A9XAH257	Acti 9 comb busbar aux2P 100A 57 modules	G-29
A9XAH357	Acti 9 comb busbar aux3P 100A 57 modules	G-29
A9XAH457	Comb busbar aux4P 100A 57mod.	G-29
A9XAH557	Comb busbar aux5P 100A 57mod.	G-29
A9XAH657	Comb busbar aux3P repar. 100A 57mod.	G-29
A9XPCD04	Acti 9 set of 4 connectors	G-29, G-30
A9XPCM04	Acti 9 set of 4 connectors	G-29, G-30
A9XPE110	Acti 9 set of 10 end caps 1P	G-29
A9XPE210	Acti 9 set of 10 end caps 2P	G-29
A9XPE310	Acti 9 set of 10 end caps 3P	G-29
A9XPE410	Acti 9 set of 10 end caps 4P	G-29
A9XPH106	Acti 9 comb busbar 1P 100A 6 modules	G-29
A9XPH112	Acti 9 comb busbar 1P 100A 12 modules	G-29
A9XPH124	Acti 9 comb busbar 1P 100A 24 modules	G-29
A9XPH157	Acti 9 comb busbar 1P 100A 57 modules	G-29
A9XPH212	Acti 9 comb busbar 2P 100A 12 modules	G-29
A9XPH224	Acti 9 comb busbar 2P 100A 24 modules	G-29
A9XPH257	Acti 9 comb busbar 2P 100A 57 modules	G-29
A9XPH312	Acti 9 comb busbar 3P 100A 12 modules	G-29
A9XPH324	Acti 9 comb busbar 3P 100A 24 modules	G-29
A9XPH357	Acti9 - comb busbar - 3L - 18 mm	G-29
A9XPH412	Acti9 comb busbar 4P 100a 12 modules	G-29
A9XPH424	Acti9 comb busbar 4P 100a 24 modules	G-29
A9XPH457	Acti9 comb busbar 4P 100a 57 modules	G-29
A9XPH512	Acti9 comb busbar 4P repar. 100a 12 m	G-29
A9XPH518	Acti9 comb busbar 4P repar. 100a 18 m	G-29
A9XPH524	Acti9 comb busbar 4P repar. 100a 24 m	G-29
A9XPH557	Acti9 comb busbar 4P repar. 100a 57 m	G-29
A9XPM212	Comb busbar 2P 100A 12mod.	G-30
A9XPM412	#N/A	G-30
A9XPM512	Comb busbar 4P repar. 100A 12mod.	G-30
A9XPT920	Set of 20 tooth caps	G-29, G-30

Index Of Commercial References With Description

Com. no.	Description	Page
D...		
DZ5CA005	Cable end 0,5	G-41
DZ5CA007	Cable end insulated markable, 0,75mm ²	G-41
DZ5CA010	Cable end insulated markable, 1mm ²	G-41
DZ5CA015	Cable ends	G-41
DZ5CA025	Cable end insulated markable, 2,5mm ²	G-41
DZ5CA042	Cable end insulated for clip-in marker	G-41
DZ5CA062	Cable end insulated for clip-in marker	G-41
DZ5CA102	Cable end insulated for clip-in marker	G-41
DZ5CA162	Cable end insulated for clip-in marker	G-41
DZ5CA253	Cable end, Linergy TR cable ends	G-41
DZ5CA352	Cable end 35mm ²	G-41
DZ5CA502	Cable end 50mm ²	G-41
DZ5CE005	Cable ends, Linergy TR cable ends, 0.5mm ²	G-41
DZ5CE007	Cable ends, Linergy TR cable ends, 0.75mm ²	G-41
DZ5CE010	Cable ends, Linergy TR cable ends, 1mm ²	G-41
DZ5CE015	Cable ends, Linergy TR cable ends, 1.5mm ²	G-41
DZ5CE025	Cable ends, Linergy TR cable ends, 2.5mm ²	G-41
DZ5CE042	Cable ends, Linergy TR cable ends, 6mm ²	G-41
DZ5CE062	Cable ends, Linergy TR cable ends, 6mm ²	G-41
DZ5CE102	Cable end insulated for clip-in marker, 10mm ²	G-41
DZ5CE162	Cable end insulated for clip-in marker, 16mm ²	G-41
DZ5CE252	Cable end insulated for clip-in marker, 25mm ²	G-41
DZ5CE352	Cable end insulated for clip-in marker, 35mm ²	G-41
DZ5CE502	Cable end insulated for clip-in marker, 50mm ²	G-41
G...		
GS1AP33	Terminal protection shrouds, TeSys GS, for 3-pole switches 100-160 A	E-60
GS1AP34	Terminal protection shrouds, TeSys GS, for 4-pole switches 100-160 A	E-60
GS1AP43	Terminal protection shrouds, TeSys GS, for 3-pole switches 160-400 A	E-60
GS1AP44	Terminal protection shrouds, TeSys GS, for 4-pole switches 160-400 A	E-60
LGY...		
LGY4193	Busbar support, Linergy BS, 630A	G-9
LGY4230	Plate with rj45 female connector	G-35

Com. no.	Description	Page
LGY4231	Plate with 8p auxiliary connectors	G-35
LGY112510	Screw distribution block 1P 125a 10holes	G-26
LGY116013	Screw distribution block 1P 160A 13holes	G-26
LGY125014	Screw distribution block 1P 250A 14holes	G-26
LGY410028	Screw distribution block 4P 100A 28holes	G-26
LGY412548	Screw distribution block 4P 125a 48holes	G-26
LGY412560	Screw distribution block 4P 125a 60holes	G-26
LGY416048	Screw distribution block 4P 160A 48holes	G-26
LGYN1007	Additional neutral bar for sbl n 100A 7h	G-26
LGYN12512	Additional neutral bar for sbl n 125a 12	G-26
LGYN12515	Additional neutral bar for sbl n 125a 15	G-26
LV4...		
LV426912	Long terminal shield 3P iec/ul dis	E-35, E-36
LV426913	Long terminal shield 4P iec/ul dis and v	E-35, E-36
LV429218	Aluminium bare cable connectors, ComPacT NSX	E-56
LV429219	Aluminium bare cable connectors, ComPacT NSX	E-56
LV429235	2 Short rear connections	E-20, E-21, E-22, E-23, E-24, E-29, E-31, E-32, E-30, E-33, E-34, E-40
LV429236	Escutcheon collar for toggle	E-20, E-21, E-22, E-23, E-24, E-29, E-30, E-31, E-32, E-33, E-34, E-40
LV429244	Aluminium bare cable connectors	E-56
LV429245	Aluminium bare cable connectors	E-56
LV429248	Aluminium bare cable connectors	E-56
LV429249	Aluminium bare cable connectors	E-56
LV429252	Crimp lugs for copper cable	E-56
LV429253	Crimp lugs for copper cable	E-56
LV429254	Crimp lugs for copper cable	E-56
LV429256	Crimp lugs for copper cable	E-56
LV429257	Crimp lugs for copper cable	E-56
LV429258	Crimp lugs for copper cable	E-56
LV429284	Escutcheon collar for Vigi chassis ns	E-24, E-29
LV429285	Escutcheon with collar for Vigi module	E-22, E-23, E-24, E-27, E-28, E-29, E-33, E-34

Index Of Commercial References With Description

Com. no.	Description	Page	Com. no.	Description	Page
LV429286	Chassis locking kit, ComPact NSX	E-24	LV432500	Crimp lugs for copper cable	E-57
LV429306	1 Connections adapter 3P for plug in bas	E-21, E-23, E-24, E-29, E-30, E-32, E-34	LV432501	Crimp lugs for copper cable	E-57
LV429307	1 Connections adapter 4P for plug in bas	E-21, E-23, E-24, E-29, E-30, E-32, E-34	LV432502	Crimp lugs for copper cable	E-57
LV429316	IP40 escutcheon for Vigi module	E-27, E-28, E-33, E-34	LV432503	Crimp lugs for copper cable	E-57
LV429358	Accessory for sourcechangeover switch do	E-50, E-51	LV432504	Crimp lugs for aluminium cable	E-57
LV429359	Accessory for sourcechangeover switch do	E-50, E-51, E-52, E-53	LV432505	4 Crimp lugs - for aluminium cable	E-57
LV429369	Mechanical interlocking for 2 rot handle	E-50	LV432506	Crimp lugs for aluminium cable	E-57
LV429504	3 Crimp lugs for aluminium cable 150 mm ²	E-56	LV432507	Crimp lugs for aluminium cable	E-57
LV429505	Crimp lugs for aluminium cable	E-56	LV432516	3P plug-in base	E-40
LV429506	Connection accessories, Compact NSX	E-56	LV432534	Escutcheon collar for toggle	E-24, E-29, E-30
LV429507	4 Al 185mm ² crimp lugs ph barriers inv/	E-56	LV432584	1 Connections adapter 3P for plug in bas	E-21, E-23, E-24, E-26, E-28, E-29, E-30
LV429515	1 3P short terminal shield	E-20, E-21, E-22, E-23, E-24, E-29, E-30, E-31, E-32, E-33, E-34, E-50, E-51	LV432585	1 Connections adapter 4P for plug in bas	E-21, E-23, E-24, E-26, E-28, E-29, E-30
LV429516	1 4P short terminal shield	E-20, E-21, E-22, E-23, E-24, E-29, E-30, E-31, E-32, E-33, E-34, E-50, E-51	LV432591	1 3P short terminal shield	E-20, E-21, E-22, E-23, E-24, E-25, E-26, E-27, E-28, E-29, E-30, E-50, E-51
LV429517	1 3P long terminal shield	E-20, E-21, E-22, E-23, E-24, E-29, E-30, E-31, E-32, E-33, E-34, E-50, E-51	LV432592	1 4P short terminal shield	E-20, E-21, E-22, E-23, E-24, E-25, E-26, E-27, E-28, E-29, E-30, E-40, E-50, E-51
LV429518	1 4P long terminal shield	E-20, E-21, E-22, E-23, E-24, E-29, E-30, E-31, E-32, E-33, E-34, E-40, E-50, E-51, E-52, E-53, E-56	LV432593	1 3P long terminal shield	E-20, E-21, E-22, E-23, E-24, E-25, E-26, E-27, E-28, E-29, E-30, E-50, E-51
LV432475	2 Short rear connections	E-20, E-21, E-22, E-23, E-25, E-26, E-24, E-27, E-28, E-29, E-30, E-40	LV432594	1 4P long terminal shield	E-20, E-21, E-22, E-23, E-24, E-25, E-26, E-27, E-28, E-29, E-30, E-40, E-50, E-51, E-52, E-53
LV432476	2 Long rear connections	E-20, E-21, E-22, E-23, E-24, E-25, E-26, E-27, E-28, E-29, E-30, E-40	LV432595	1 3P long terminal shield for spreader	E-50, E-51
LV432479	Aluminium bare cable connectors	E-57	LV432596	1 4P long terminal shield for spreader	E-50, E-51
LV432480	Aluminium bare cable connectors	E-57	LV432619	Accessory for sourcechangeover switch do	E-50, E-51
			LV432620	Accessory for sourcechangeover switch do	E-50, E-51, E-52, E-53
			LV432621	Rotary handle mechanical interlocking n	E-50
			LV434021	Energy sensor PowerTag Monoconnect 250A	E-56
			LV480756	Terminal covers x2	E-59
			LV480811	ISFT160 feeding busbar for 2 devices	E-59
			LV480812	ISFT160 feeding busbar for 3 devices	E-59

Index Of Commercial References With Description

Com. no.	Description	Page
LV480813	ISFT160 feeding busbar for 4 devices	E-59
LV480814	ISFT160 distribution con 3 x 16mm	E-59
LV480818	ISFT160 feeding clamp 25 - 95mm ²	E-59
LV480819	ISFT160 terminal shields	E-59
LV480824	ISFT250 terminal shields	E-59
LV480827	ISFT400 terminal shields	E-59
LV480831	ISFT630 terminal shields	E-59
LV480854	Kit for direct mounting 185mm	E-58
LV480855	Direct connection to 185mm busbars for 2 devices	E-58
LV480869	Sidewise angle bracket for side frame	E-58
LV480870	Length adaptor and ident. Label holder	E-58

LVS01...

LVS01005	10 black line L900 stickers	F-22
LVS01006	10 black arrow out. Stickers	F-22
LVS01007	10 black arrow inc. stickers	F-22
LVS01008	10 black transformer stickers	F-22
LVS01094	1/4 T locking front plate (2 by 10)	I-5
LVS01100	Side panel access.Syst.P	I-6
LVS01101	IP55 back access.Syst.P	I-5
LVS01102	IP55 side panel access Syst.P	I-6
LVS01103	IP55 roof access. Syst.P	I-6
LVS01104	Framework access.Syst.P	I-4
LVS01105	IP30/55 door access.Syst.P	I-7
LVS01106	Back panel access.Syst.P	I-5
LVS01109	12 Linergy LGY busbar stops	G-4, G-7
LVS01110	W150 plain wicket door	E-61, I-5
LVS01112	Roof access. Syst.P	I-6
LVS01120	Frame bot. Cross-member L650	I-7
LVS01121	Frame bot. Cross-member L150+650	I-7
LVS01123	Fr.PI.Sup. Striker kit Syst.P	I-6
LVS01124	locking kit for IP31/IP55 door (Ipc Arc)	I-7
LVS01126	Green Cover W400 P for Wireless PaS	I-8
LVS01127	Green Cover W650 P for Wireless PaS	I-8
LVS01128	Green Cover W800 P for Wireless PaS	I-8
LVS01130	Linergy LGYE busbar screw plate kit	G-13, I-5
LVS01198	Ph/PrismaSeT Plus IP55 cub. Assoc.	I-6
LVS01199	combination kit - Prisma (before 2005)-Prisma IP30 (before 2020)	I-6
LVS01201	2 IPXXB clip-on covers Linergy BW	I-4
LVS01202	4 IPXXB covers Linergy FM 200	G-25, I-4
LVS01210	Linergy BW accessories 160-400A	I-4
LVS01215	Cables membrane 70 x 40 (*5)	F-27

Com. no.	Description	Page
LVS01219	Rotative Handle With Rod	I-7
LVS01224	IP30 reinforced plain door IK10 W650	F-14
LVS01225	IP30 reinforced plain door IK10 W800	F-14

LVS03...

LVS03030	M.PI. Nsx/Cvs/Ins 250 Hz.fixed Toggle	F-25
LVS03050	M.PI. NSX/CVS/Vigi/INS 250 v. fix. toggle	E-30
LVS03050	#N/A	E-30
LVS03051	M.PI.NSX/CVS/INS 250 v. fixed rot.handle	E-30
LVS03152	M.Plate for 2 3P-meters	E-65
LVS03164	20 M4 clip-nuts mod.dev.rails	F-24
LVS03165	20 M5 clip-nuts mod.dev.rails	F-24
LVS03166	20 M6 clip-nuts mod.dev.rails	F-24
LVS03180	20 slotted m.PI. M4 clip-nuts	F-24
LVS03181	20 slotted m.PI. M5 clip-nuts	F-24
LVS03182	20 slotted m.PI. M6 clip-nuts	F-24
LVS03185	4 hexagonal spacers M5 H9	F-24
LVS03186	4 hexagonal spacers M5 H23	F-24
LVS03187	4 hexagonal spacers M5 H55	F-24
LVS03194	20 hexa.Spacer M6 captive nuts	F-24
LVS03195	4 hexagonal spacers M6 H9	F-24
LVS03196	4 hexagonal spacers M6 H23	F-24
LVS03197	4 hexagonal spacers M6 H55	F-24
LVS03198	4 hexagonal spacers M6 H25	F-24
LVS03199	4 hexagonal spacers M8 H40+10	F-24
LVS03202	Modular front plate W600/W650 2m	E-68
LVS03203	Modular front plate W600/W650 3m	E-62, E-63, E-68
LVS03204	Modular front plate W600/W650 4m	E-63, E-64
LVS03205	Modular front plate W600/W650 5m	E-36, E-37, E-62, E-64
LVS03206	Front Plate, Transfer Pact, 3P/4P, 63A, Vertical, W650, 6M	E-54
LVS03207	Front Plate, Transfer Pact, 3P/4P, 160A, Vertical, W650, 8M	E-55
LVS03210	Faceplate TransferPact PrismaSeT P	E-56
LVS03211	Faceplate TransferPact PrismaSeT P	E-57
LVS03213	Modular front plate W300 3m	E-63
LVS03214	Modular front plate W300 4m	E-63, E-64
LVS03220	Blanking strip L1000	E-36, E-37, E-63, E-64, E-68, F-22
LVS03221	4 divisible blanking plates W90	E-36, E-37, E-63, E-64, E-68, F-22
LVS03222	NSX blanking plate electronic trip unit	E-31, E-32, E-33, E-34, F-22
LVS03223	Front plate 3 modular rows W600/W650 8m	E-63

Index Of Commercial References With Description

Com. no.	Description	Page	Com. no.	Description	Page
LVS03225	Front plate NSXm vert. Rotative W400 5m	E-38	LVS03344	Transparent front plate W600/ W650 9m	E-65, F-23
LVS03226	Front plate NSXm -3P vert.Rot. W650 5m	E-36	LVS03345	Transparent front plate W600/ W650 12m	F-23
LVS03227	Front plate NSXm -4P vert.Rot. W650 5m	E-36	LVS03346	FRONT PLATE HORI GS 250A 7M W650	E-60
LVS03235	Fr.PI.changeover INS-INV250 rot W600 5m	E-52	LVS03347	FRONT PLATE HORI GS 400A 8M W650	E-60
LVS03241	Fr.PI.3-4 Vigi NSX/CVS250 v.fix. tog. 7m	E-31, E-32	LVS03349	FRONT PLATE VERT GS 250-400A 6M W650	E-60
LVS03243	Fr.PI.3-4 NSX/CVS250 v.fixed tog/ rot 5m	E-29, E-31, E-32, E-33, E-34	LVS03352	Transparent front plate W300 4m	F-23
LVS03244	Fr.PI.3-4Vigi NSX/CVS250 v.rot/tl/ plug 7m	E-29, E-33, E-34	LVS03353	Transparent front plate W300 6m	F-23
LVS03245	Fr.PI. changeover NSX250 v.rot. W600 5m	E-50	LVS03354	Transparent front plate W300 9m	F-23
LVS03247	Front plate changeover INS250 W600 5m	E-53	LVS03371	Fixed L650 front plate support frame	E-57, F-5
LVS03248	Front plate INS250 vertical W600/ W650 5m	E-40	LVS03401	W650 modular device rail PrismaSeT P Active	E-62, E-63, E-64, E-68, F-26
LVS03249	Blanking plate NSX/CVS250-EZC100 v. W147	E-31, E-32, E-33, E-34, F-22	LVS03404	W400 adjustable mod. Dev. Rail PrismaSeT P Active	E-63
LVS03253	Fr.PI. NSX/CVS 250 v.fix.tog/rot W300 9m	E-30	LVS03402	W650 adjustable mod. Dev. Rail PrismaSeT	E-37, E-62, E-68, F-26, G-38
LVS03274	Front plate INS630 vertic. W600/ W650 10m	E-40	LVS03404	W400 adjustable mod. Dev. Rail PrismaSeT P Active	E-63, E-64, E-68
LVS03275	Fr.PI.NSX/CVS630 v.tog/rot/plug W600 9m	E-25, E-26, E-27, E-28, E-29	LVS03405	Mount.PI NSXm toggle/rot-3P/4P vert.W400	E-38
LVS03283	Fr.Plate NSX/CVS 630 v.fix.rot. W300 12m	E-30	LVS03406	Mount.PI NSXmVigi toggle-3P/4P vert.W650	E-36
LVS03293	Front plate Vigi NSX250 v.tog. W300 11m	E-30	LVS03409	Mount.PI NSXm toggle/rot-3P/4P horz.W650	E-35
LVS03297	Fr.PI.Vigi NSX/CVS630 v.tog/rot W600 9m	E-25, E-26, E-27, E-28, E-29	LVS03410	Mount.PI NSXm toggle/rot-3P/4P vert.W650	E-36
LVS03299	Front pl.Vigi NSX630 v.fix.tog. W300 10m	E-30	LVS03411	Mount.PI NSX/CVS.Toggle -3P 250A hz W650	E-20
LVS03308	FRONT PL. GS32 3P/4P W600 HZ/ VT 3M	E-60	LVS03412	Mount.PI NSX/CVS.Toggle -4P 250A hz W650	E-20, E-40
LVS03309	FRONT PL. GS63-160 3P/4P W600 HZ/VT 5M	E-60	LVS03413	Mount.PI NSX/CVS plugin -3P 250A hz W650	E-21, E-22, E-23
LVS03320	Front plate ISFT 100 vertic W600/ W650 6m	E-59	LVS03414	Mount.PI NSX/CVS plugin -4P 250A hz W650	E-21, E-22, E-23
LVS03321	Front plate ISFT 160 vertic W600/ W650 6m	E-59	LVS03415	Mount.PI NSX withd -3/4P 250A hz W650	E-24
LVS03322	Front plate ISFT 250 vertical W650 9m	E-59	LVS03416	Mounting plate for Linergy FC NSXm	E-36
LVS03323	Front plate ISFT 400 vertical W650 9m	E-59	LVS03417	M.PI.Hz.NS250 c/o mot. Or ua/ba	E-42, E-43, E-44, E-45, E-46, E-47, E-48, E-51
LVS03324	Front plate ISFT 630 vertical W650 8m	E-59	LVS03420	M.PI.4Vigi/NSX/CVS/ 3INS 250 v. Fix. Toggle	E-31, E-40
LVS03325	Front plate ISFT100N vertical W600/650 8m	E-59	LVS03421	M.PI.3-4V.Withd.NS250 devices	E-29, E-32, E-34
LVS03330	Fr. plate NSXm/Vigi/SDX hz.Tog. W600 3m	E-35	LVS03422	M.Plate 4 Vigi NSX/CVS 250 v. Fixed rot/tel	E-33, E-34
LVS03331	Fr. plate NSXm hz.Rot.W600 3m	E-35	LVS03423	M.PI.3-4 V.Withd.NS250 polyp.	E-32
LVS03342	Transparent front plate W600/ W650 4m	E-62, E-68, F-23	LVS03424	Mounting Plate, Transfer Pact, 3P/4P, 63A, Vertical W650	E-54
LVS03343	Transparent front plate W600/ W650 6m	E-65, F-23	LVS03425	Mounting Plate, Transfer Pact, 3P/4P, 160A, Vertical W650	E-55
			LVS03428	Mount.PI changeover NSX/INS 250 rot.Vert	E-50, E-52, E-53

Index Of Commercial References With Description

Com. no.	Description	Page
LVS03429	Perforated cover TransferPacT, 32-100A	E-56, E-57
LVS03451	Mount.PI NSX/CVS.Toggle -3P 630A hz W650	E-20
LVS03452	Mount.PI NSX/CVS.Toggle -4P 630A hz W650	E-20, E-40
LVS03453	Mount.PI NSX/CVS plugin -3P 630A hz W650	E-21, E-22, E-23
LVS03454	Mount.PI NSX/CVS plugin -4P 630A hz W650	E-21, E-22, E-23
LVS03457	Mount.PI changeover NSX/INS 630 mot.Horz	E-51
LVS03458	Mount.PI changeover NSX/INS 630 rot.Horz	E-50, E-52, E-53
LVS03460	Kit For Control Support	E-22
LVS03461	Mount.PI 2 NSX/CVS/INS -3P/4P 630A vert.	E-25, E-26, E-27, E-28, E-29, E-40
LVS03462	Mount.PI NSX withd -3/4P 630A hz W650	E-24
LVS03480	Mount.PI NS fixed -3P/4P 1000A hz.W650	E-17
LVS03482	Mount.PI NS fixed -3P/4P 1600A vert.W650	E-15, E-16
LVS03483	M.PI NT/NS withd -3P/4P 1600A vert.W650	E-10, E-11, E-15, E-16, E-46, E-47, E-48
LVS03484	Mount.PI NT fixed -3P/4P 1600A vert.W650	E-10, E-11, E-46, E-47, E-48
LVS03487	Mount.PI NS fixed -3P/4P 1600A vert.W400	E-18, E-30
LVS03488	Mount.PI NT/NS withd -3P 1600A vert.W400	E-12, E-18
LVS03489	Mount.PI NT fixed -3P 1600A vert. W400	E-12
LVS03491	Mount.PI changeover NS1000 rot. Horz.W650	E-49
LVS03500	Mount.PI NW fixed/withd -3P/4P vert.W650	E-2, E-4, E-6, E-8, E-9, E-42, E-43, E-44, E-45
LVS03501	M.PI NS3200 INS-INV2500 fixed vertical	E-14, E-39
LVS03508	Prisma P M.Plate 2 3PH Counters 3PH 6M	E-65
LVS03545	M.PI.100mm b/centres ISFL160	E-58
LVS03546	M.PI.185mm b/centres ISFL630	E-58
LVS03553	M.Plate ISFT 100N	E-59
LVS03554	M.PI.ISFT100	E-59
LVS03555	M.PI busbar ISFT 100N/160	E-59
LVS03556	M.PI.ISFT160	E-59
LVS03557	M.PI.ISFT630	E-59
LVS03559	M. PL GS 3P/4P 32A H+V W650	E-60
LVS03560	M.PL GS 3P/4P 63-100-160A HORZ W650	E-60
LVS03561	Canalis support	E-4, E-11, E-16
LVS03563	M. PL GS 63-160A VERT W650	E-60
LVS03564	M. PL GS 250A HORI W650	E-60

Com. no.	Description	Page
LVS03565	M. PL GS 250A VERT W650	E-60
LVS03566	M. PL GS 400A HORI W650	E-60
LVS03567	M. PL GS 400A VERT W650	E-60
LVS03569	W800 plain backplate 36m	F-25
LVS03570	Plain backplate 36m W650	F-25
LVS03571	Slotted mounting plate 4modules	E-62, F-26
LVS03572	Slotted mounting plate 6modules	E-62, F-26
LVS03574	Slotted mounting plate 12m	F-26
LVS03580	4 Angle brackets + screws	F-24
LVS03581	2 universal angle brackets	F-24, F-26, F-28, G-38
LVS03582	6 Universal inserts Syst.P	F-24, F-28
LVS03583	6 universal angle brackets	F-24, H-6
LVS03584	2 Side.Cross-members W400 D400	E-7, F-20, F-28, G-38
LVS03586	2 Side.Cross-members W200 D600	E-7, F-20, F-28
LVS03587	2 Longitudinal cross-mbers W650	F-20, F-28
LVS03590	Rear modular device rail W650	F-26
LVS03593	2 Slide rails+angle brackets	F-25, F-26, F-28
LVS03595	System G adapter W500	E-65, F-25
LVS03596	System G adapter W250	E-30, F-25
LVS03604	Fr.PI Vigi NSX.Tog/CVS.Rot -3P 250 hz 3m	E-20, E-21, E-22, E-23
LVS03606	Fr.PI Vigi NSX.Tog/CVS.Rot -4P 250 hz 4m	E-20, E-21, E-22, E-23
LVS03616	Fr.PI.Hz.NSX250 c/over mot.	E-51
LVS03617	Fr.PI.Hz.INS250	E-40
LVS03618	Fr.PI.Hz. Withd. NSX250	E-24
LVS03620	Fr.PI.3-4 V.INS250 devices	E-40
LVS03643	Fr.PI Vigi NSX.Tog/CVS.Rot -3P 630 hz 3m	E-20, E-21, E-22, E-23
LVS03644	Fr.PI Vigi NSX.Tog/CVS.Rot -4P 630 hz 4m	E-20, E-21, E-22, E-23
LVS03656	Fr.PI.Hz.NSX630 c/over mot.	E-51
LVS03657	Fr.PI.Hz. Withd. NSX630	E-24
LVS03658	Fr.PI.Hz.INS630	E-40
LVS03659	Fr.PI.Hz.NSX-INS630 c/over rot	E-50, E-52
LVS03661	Fr.PI.Hz.Ns-INS630 changeover	E-53
LVS03663	Fr.PI. Vert. 2 NSX630	E-25, E-26, E-27, E-28, E-29
LVS03666	Fr.PI.Vertical 2 NSX630 Vigi	E-25, E-26, E-27, E-28, E-29
LVS03671	Fr.PI.Ua or ba	E-42, E-43, E-44, E-45, E-46, E-47, E-48, E-51
LVS03687	Fr.PI.Hz.Fix.NS1600 tog/rot.4P	E-17
LVS03690	Fr.PI.V.Fixed NS1600	E-15
LVS03701	Fr.PI.V.Fixed mot.NS1600 sp	E-16
LVS03691	Fr.PI.Withd.NS1600-NT	E-10, E-11, E-15, E-16, E-46, E-47, E-48

Index Of Commercial References With Description

Com. no.	Description	Page	Com. no.	Description	Page
LVS03692	Fr.PI.V.Fixed NT	E-10, E-11, E-46, E-47, E-48	LVS03805	Plain front plate W600/W650 5m	E-2, E-4, E-11, E-16, E-25, E-27, E-42, E-43, E-44, E-62, F-23, G-38
LVS03695	Fr.PI.Hz.NS1600 changeover rot.	E-49	LVS03806	Plain front plate W600/W650 6m	E-8, E-11, E-14, E-16, E-42, E-43, E-44, E-45, E-62, E-65, F-23, G-38
LVS03697	Fr.PI.V.Fix.NS1600 3-4P W400	E-18	LVS03808	Plain front plate W600/W650 12m	E-6, F-23
LVS03698	Fr.PI.V.Fixed NT 3P W400	E-12	LVS03811	Plain front plate W300 1m	E-30, E-38, E-64, F-23
LVS03699	Fr.PI.Withd.NS1600-NT 3P W400	E-12, E-18	LVS03812	Plain front plate W300 2m	E-30, E-38, F-23
LVS03701	Fr.PI.V.Fixed mot.NS1600 sp	E-16	LVS03813	Plain front plate W300 3m	F-23
LVS03709	Front plate dedicated NW	E-8, E-9	LVS03814	Plain front plate W300 4m	E-30, E-68, F-23
LVS03710	Fr.PI.Withdrawable NW	E-2, E-4, E-6, E-8, E-42, E-43, E-44, E-45	LVS03815	Plain front plate W300 5m	F-23
LVS03711	Fr.PI.Fixed NW	E-2, E-4, E-6, E-42, E-43, E-44, E-45	LVS03816	Plain front plate W300 6m	E-30, F-23
LVS03713	Fr.PI.INS1600 3P	E-39	LVS03817	Plain front plate W300 9m	F-23
LVS03714	Fr.PI.INS1600 4P	E-39	LVS03891	IP30 ventilated front plate W600/W650 1m	F-30
LVS03715	Fr.PI.INS2500 3P/4P	E-39	LVS03895	IP30 ventilated front plate W600/W650 3m	F-30
LVS03716	Fr.PI.NS3200	E-14	LVS03900	Support 72x72 met.dev/pb for 03904/03928	E-12, E-18, E-67
LVS03722	Hinged fr.PI.13M W400	E-12, E-18, F-23	LVS03901	Support 96x96 met.dev/pb for 03904/03928	E-12, E-18, E-67
LVS03723	Hinged fr.PI.Hsi 13m W400	E-12, E-18	LVS03902	Supp.cut-out 72x72 met.dev/pb 03904/03928	E-12, E-18, E-67
LVS03735	Ip20 front ISFL 185mm bc W650	E-58	LVS03903	Supp.cut-out 96x96met.dev/pb 03904/03928	E-12, E-18, E-67
LVS03736	Fr.PI.ISFL 160	E-58	LVS03904	Fr.PI.72 ² /96 ² cut-out met.dev/pb W600 3m	E-66, E-67
LVS03740	Blanking plate ISFL 160	E-58	LVS03907	Support 72x72 met.dev/pb for 03910/03912	E-67
LVS03741	Blanking plate ISFL 630	E-58	LVS03908	Support 96x96 met.dev/pb for 03911/03913	E-67
LVS03801	Plain front plate W600/W650 1m	E-10, E-25, E-26, E-27, E-28, E-29, E-31, E-32, E-33, E-34, E-36, E-40, E-47, E-60, E-62, F-23	LVS03910	Fr.pl.72x72 6 Cut-Out Met.dev/Pb W600 3m	E-66, E-67
LVS03802	Plain front plate W600/W650 2m	E-8, E-6, E-10, E-14, E-15, E-25, E-26, E-27, E-28, E-29, E-31, E-32, E-33, E-34, E-36, E-40, E-46, E-48, E-50, E-52, E-53, E-56, E-57, E-59, F-23	LVS03911	Fr.pl.96x96 3 Cut-Out Met.dev/Pb W600 3m	E-66, E-67, E-68
LVS03803	Plain front plate W600/W650 3m	E-4, E-10, E-11, E-15, E-16, E-25, E-26, E-27, E-28, E-29, E-31, E-33, E-39, E-46, E-47, E-48, E-50, E-62, F-23, G-38	LVS03913	Fr.PI.96X96 1 cut-out met.dev/pb W600 3m	E-66, E-67, E-68
LVS03804	Plain front plate W600/W650 4m	E-2, E-4, E-6, E-8, E-9, E-10, E-14, E-15, E-25, E-27, E-39, E-42, E-44, E-46, E-48, E-62, E-68, F-23	LVS03914	Fr.PI. 12 push-button/lamps W600/W650 2m	E-66, E-67
			LVS03923	Fr.PI. 1 pre cut-out 96x96 W300 3m	E-67, E-68
			LVS03928	Visor 30°for metering dev/pb 72x72/96x96	E-66, E-67
			LVS03930	Mounting plate Vigilohm xm200-300c	E-68
			LVS03932	Fr.PI. Vigilohm xm200-300c W600/W650 6m	E-68
			LVS03970	Door for capacitors W650	E-61
			LVS03979	Varpluscan horizontal mounting plate	E-61

Index Of Commercial References With Description

Com. no.	Description	Page
LVS04...		
LVS04004	Linery FM 4P dist.block 80A	G-25
LVS04008	Linery FM 4P dist.block 63A 12m 20 holes	G-25
LVS04012	Linery FM 2P dis.Block 200A 24m 24holes	G-25
LVS04013	Linery FM 3P dis.Block 200A 24m 42 holes	G-25
LVS04014	Linery FM 4P dis.Block 200A 24m 54 holes	G-25
LVS04018	Linery FM 4P dis.Block 160A 12m 27 holes	G-25
LVS04021	4P conn.Lin.BW insul.bb/lin.fm d.blk200A	G-25
LVS04024	4P conn.Lin.Bs stage bb/lin.Fm d.blk200A	G-25
LVS04026	Linery FM 4P dis.Block 200A 36m 81 holes	G-25
LVS04029	4 Conn.Lin.Bs rear bb/lin.fm d.blk 200A	G-25
LVS04030	4 Conn. Ng160/Linery FM dist. blk 160A	E-35, G-25
LVS04031	Linery DX 1P dist.Block 160A 4m 6 holes	E-37, G-22
LVS04033	Linery DP 3P d.blk/ComPacT 250A 27 holes	G-14
LVS04034	Linery DP 4P d.blk/ ComPacT250A 36 holes	G-14
LVS04038	Linery DP/NSXm 3P 160A 18T	G-15
LVS04039	Linery DP/NSXm 4P 160A 24T	E-35, E-37
LVS04039	Linery DP/NSXm 4P 160A 24T	G-15
LVS04040	Linery DX 4P 63A top incoming	G-22
LVS04041	Linery DX 4P 63A bottom incoming	G-22
LVS04045	Linery DX 4P dist.block 125A 6m 52 holes	E-37, G-22
LVS04046	Linery DX 4P d.blk/ng160 160A 6m 52 hole	E-37, G-22
LVS04047	4 Conn.Ng125/Linery DX dist. Block 125A	E-37, G-22
LVS04052	Linery BS 4P multistage bb 160A 52holes	G-11
LVS04053	Linery BS 4P multistage bb 250A 52holes	G-11
LVS04054	Linery BS 4P multistage bb 400A 52holes	G-11
LVS04055	Linery BS 4P multistage bb 630A 52holes	G-11
LVS04111	Insulated busbar - 160 A 3P - L=1000 mm (Powerclip)	D-3
LVS04112	Insulated busbar - 250 A 3P - L=1000 mm (Powerclip)	D-3
LVS04113	Insulated busbar - 400 A 3P - L=1000 mm (Powerclip)	D-3
LVS04114	Insulated busbar - 630 A 3P - L=1000 mm (Powerclip)	D-3
LVS04116	Insulated busbar - 160 A 3P - L=1400 mm (Powerclip)	D-3
LVS04117	Insulated busbar - 250 A 3P - L=1400 mm (Powerclip)	D-3

Com. no.	Description	Page
LVS04118	Insulated busbar - 400 A 3P - L=1400 mm (Powerclip)	D-3
LVS04119	Insulated busbar - 630 A 3P - L=1400 mm	D-3
LVS04121	Insulated busbar - 160 A 4P - L=1000 mm (Powerclip)	D-3
LVS04122	Insulated busbar - 250 A 4P - L=1000 mm (Powerclip)	D-3
LVS04123	Insulated busbar - 400 A 4P - L=1000 mm (Powerclip)	D-3
LVS04124	Insulated busbar - 630 A 4P - L=1000 mm (Powerclip)	D-3
LVS04127	Insulated busbar - 250 A 4P - L=1400 mm (Powerclip)	D-3
LVS04128	Insulated busbar - 400 A 4P - L=1400 mm (Powerclip) 04128	D-3
LVS04129	Insulated busbar - 630 A 4P - L=1400 mm (Powerclip)	D-3
LVS04145	Cu connections 125A 4P W230	E-35, E-36
LVS04146	Cu connections 160A 4P W250	E-35, E-36
LVS04194	20 Bolts 8.8 Class m6x20 /5mm copper bar	G-12
LVS04195	40 Screws 8.8 Class m6x16/ threaded bar	G-12
LVS04197	Barrier h1500mm/Linery BS multistage bb	G-10
LVS04198	Barrier h100mm /Linery BS rear busbar	G-9
LVS04200	Earth bar 35 ² /40 clamps L450 Linery TB	G-36
LVS04201	12X3mm dir.Earth bar 35 ² L330 Linery TB	G-36
LVS04202	2 Earth bar 35 ² /20 clamp L200 Linery TB	G-36
LVS04205	2 Earth bar mod.dev.rail sup.	G-36
LVS04210	2 Insulat.Spacers/neutral bar Linery TB	G-36
LVS04214	4 Earth blk 12x4 ² term.Clamp Linery TB	G-36
LVS04215	4 Earth blk 3x16 ² term.Clamp Linery TB	G-36
LVS04224	5 practic raisers	F-24
LVS04226	2 modular device rails L1600	F-26, G-38
LVS04227	Modular Rail & Extensions - L600	E-64
LVS04229	20 Tab conn.M10 volt.Tap-offs	G-13
LVS04233	Trunking door L2000	F-27
LVS04234	10 wiring through fr.grommets	F-27
LVS04235	Wiring to door flex.trunking	F-27
LVS04239	12 Hz.cable straps	F-27
LVS04243	4 covers hz.cable straps	F-27
LVS04255	12 Hz.trunking supports	F-27
LVS04256	10 Hz. adjustable trunking sup	F-27
LVS04257	4Hz.trunking sections L450+sup	F-27
LVS04262	12 Vertical cable straps	F-27
LVS04263	2 V.cable straps L1000 covers	F-27
LVS04267	Vertical trunking L2000	F-27

Index Of Commercial References With Description

Com. no.	Description	Page	Com. no.	Description	Page
LVS04403	Linerigy FC distribution block for ComPacT NSX250 3P toggle/ fixed + connection	E-31, G-16	LVS04453	Connection NSX toggle-3P 630A fixed horz	E-20
LVS04404	Linerigy FC distribution block for ComPacT NSX250 4P toggle/ fixed + connection	E-31, E-40, G-16	LVS04454	Connection NSX toggle-4P 630A fixed horz	E-20
LVS04405	Linerigy FC distribution block for ComPacT NSX2503P fixed/ plug-in + connection	E-32, E-33, E-34, G-16	LVS04455	Conn.Transf. NSX tog -3P 630A fixed hz	E-20
LVS04406	Linerigy FC distribution block for ComPacT NSX250 4P fixed/ plug-in + connection	E-32, E-33, E-34, G-16	LVS04456	Conn.Transf. NSX tog -4P 630A fixed hz	E-20
LVS04407	Linerigy FC distribution block for ComPacT NSX250 3P fixed W/O connection	E-31, E-32, E-33, E-34, G-16	LVS04459	Universal connection in duct 630A 3P	E-20, E-21, E-22, E-23, E-24
LVS04408	Linerigy FC distribution block for ComPacT NSX250 4P fixed W/O connection	E-31, E-32, E-33, E-34, E-40, G-16	LVS04460	Universal connection in duct 630A 4P	E-20, E-21, E-22, E-23, E-24
LVS04410	Linerigy FC distribution block for ComPacT NSXm 160A 3P toggle/ fixed + connection	E-36, G-18	LVS04461	Connection NSX toggle-3P 630A plugin hz	E-21, E-24
LVS04411	Linerigy FC distribution block for ComPacT NSXm 160A 4P toggle/ fixed + connection	E-36, G-18	LVS04462	Connection NSX toggle-4P 630A plugin hz	E-21, E-24
LVS04412	Linerigy FC distribution block for ComPacT NSXm 160A 3P toggle/ fixed	E-36, G-18	LVS04473	Connection NS -3P 1000A fixed horizontal	E-17, I-22, I-37
LVS04413	Linerigy FC distribution block for ComPacT NSXm 160A 4P toggle/ fixed	E-36, G-18	LVS04474	Connection NT -4P 1000A fixed horizontal	E-17, I-22, I-37
LVS04416	Linerigy FC distribution block for ComPacT NSXm 160A 3P toggle/ fixed with VIGI + connection	E-36, G-18	LVS04475	Connection NT -3P 1250A fixed	E-10, E-11, I-21, I-36
LVS04417	Linerigy FC distribution block for ComPacT NSXm 160A 4P toggle/ fixed with VIGI + connection	E-36, G-18	LVS04476	Connection NT -4P 1250A fixed	E-10, E-11, I-21, I-36
LVS04418	Linerigy FC distribution block for ComPacT NSXm 160A 3P toggle/ fixed with VIGI	E-36, G-18	LVS04477	Connection NS/NT -3P 1250A withdrawable	E-10, E-11, E-15, E-16, I-20, I-35
LVS04419	Linerigy FC distribution block for ComPacT NSXm 160A 3P toggle/ fixed without connection	E-36, G-18	LVS04478	Connection NS/NT -4P 1250A withdrawable	E-10, E-11, E-15, E-16, I-20, I-35
LVS04420	Linerigy FC distribution block for ComPacT NSXm 160A 4P toggle/ fixed without connection	E-36, G-18	LVS04481	Connection INS-INV -3P 1600A fixed	E-39
LVS04423	Connection NSX toggle-3P 250A fixed horz	E-20	LVS04482	Connection INS-INV -4P 1600A fixed	E-39
LVS04424	Connection NSX toggle-4P 250A fixed horz	E-20	LVS04483	Conn.Transf. NS -3P 1000A fixed horz	E-17, I-49
LVS04425	Conn.Transf. NSX tog -3P 250A fixed horz	E-20	LVS04484	Conn.Transf. NS -4P 1000A fixed horz	E-17, I-49
LVS04426	Conn.Transf. NSX tog -4P 250A fixed horz	E-20	LVS04485	Connection NS -3P 1250A fixed	E-15, E-16, I-20, I-35
LVS04427	Conn. NSX/INS -3P 250A fixed/ withd horz	E-22, E-23, E-24, E-40	LVS04486	Connection NS -4P 1250A fixed	E-15, E-16, I-20, I-35
LVS04428	Conn. NSX/INS -4P 250A fixed/ withd horz	E-22, E-23, E-24, E-40	LVS04487	Connection NS -3P 1600A fixed	E-15, E-16, I-20, I-35
LVS04429	Universal connection in duct 250A 3P	E-20, E-21, E-22, E-23, E-24	LVS04488	Connection NS -4P 1600A fixed	E-15, E-16, I-20, I-35
LVS04430	Universal connection in duct 250A 4P	E-20, E-21, E-22, E-23, E-24	LVS04489	Connection NT -3P 1600A fixed	E-10, E-11, I-21, I-36
LVS04431	Connection NSX toggle-3P 250A plugin hz	E-21, E-24	LVS04490	Connection NT -4P 1600A fixed	E-10, E-11, I-21, I-36
LVS04432	Connection NSX toggle-4P 250A plugin hz	E-21, E-24	LVS04491	Connection NS/NT -3P 1600A withdrawable	E-10, E-11, E-15, E-16, I-20, I-35
			LVS04492	Connection NS/NT -4P 1600A withdrawable	E-10, E-11, E-15, E-16, I-20, I-35
			LVS04493	Connection horizontal LGYE NW 1600A 3P	E-3, E-5
			LVS04494	Connection horizontal LGYE NW 1600A 4P	E-3, E-5
			LVS04495	Connection horizontal LGYE NW 2500A 3P	E-3, E-5

Index Of Commercial References With Description

Com. no.	Description	Page
LVS04496	Connection horizontal LGYE NW 2500A 4P	E-3, E-5
LVS04497	Connection horizontal LGYE NW 3200A 3P	E-3, E-5
LVS04498	Connection horizontal LGYE NW 3200A 4P	E-3, E-5
LVS04502	Linery LGY vertical profile 630A L1670	G-4, G-7, G-37, I-13
LVS04503	Linery LGY vertical profile 800A L1670	G-4, G-7, G-37, I-13
LVS04504	Linery LGY vertical profile 1000A L1670	G-4, G-7
LVS04505	Linery LGY vertical profile 1250A L1670	G-4, G-7, G-37, I-13
LVS04506	Linery LGY vertical profile 1600A L1670	G-4, G-7
LVS04507	Linery LGYE vert profile 2000A L1625	G-5
LVS04508	Linery LGYE vert profile 2500A L1625	G-5
LVS04509	Linery LGYE vert profile 3200A L1625	G-5
LVS04510	Linery LGYE vert profile 4000A L1625	G-5
LVS04512	Pe v.Bar w.Holes 25x5 L1675 Linery TB	G-37
LVS04515	Pe v.Bar w.Holes 50x5 L1675 Linery TB	G-37
LVS04516	Drilled flat bar Linery BS 60x5 L1675	G-6, G-8
LVS04518	Drilled flat bar Linery BS 80x5 L1675	G-6, G-8
LVS04525	Drilled flat bar Linery BS 50x10 L1675	G-6, G-8
LVS04526	Drilled flat bar Linery BS 60x10 L1675	G-6, G-8
LVS04528	Drilled flat bar Linery BS 80x10 L1675	G-6, G-8
LVS04536	Plain hz flat bar Linery BS 60x5 L2000	G-3
LVS04538	Plain hz flat bar Linery BS 80x5 L2000	G-3
LVS04545	Plain hz flat bar Linery BS 50x10 L2000	G-3
LVS04546	Plain hz flat bar Linery BS 60x10 L2000	G-3
LVS04548	Plain hz flat bar Linery BS 80x10 L2000	G-3
LVS04550	Plain hz flat bar Linery BS100x10 L2000	G-3, G-6
LVS04552	Plain hz flat bar Linery BS120x10 L2000	G-3, G-6
LVS04560	Linery LGYE profile 630A L2000	G-2, G-5
LVS04561	Linery LGYE profile 800A L2000	G-2, G-5
LVS04562	Linery LGYE profile 1000A L2000	G-2, G-5
LVS04563	Linery LGYE profile 1250A L2000	G-2, G-5
LVS04564	Linery LGYE profile 1600A L2000	G-2, G-5
LVS04565	Linery LGYE profile 2000A L2000	G-2
LVS04566	Linery LGYE profile 2500A L2000	G-2

Com. no.	Description	Page
LVS04567	Linery LGYE profile 3200A L2000	G-2
LVS04568	Linery LGYE profile 4000A L2000	G-2
LVS04602	Linery LGYE vertical connection 1600A	G-4, G-5, G-7, G-37
LVS04603	Linery LGYE vert. Shifted connect.1600A	G-5
LVS04604	Linery LGYE vert. short connect. 2500A	G-5
LVS04605	Linery LGYE vert. Long connect. 2500A	G-5
LVS04605	Linery LGYE vert. Long connect. 2500A	G-5
LVS04607	Linery LGYE vertical connection 4000A	G-5
LVS04610	Copper Joint And Mounting Hardware For Linery Lgye Inside Angle Kit 630A-1600A	F-16
LVS04611	Copper Joint And Mounting Hardware For Linery Lgye Inside Angle Kit 2000a-2500a	F-16
LVS04613	Copper Joint And Mounting Hardware For Linery Lgye Inside Angle Kit 3200a-4000a	F-16
LVS04620	Linery LGYE horizontal joint 1600A	G-2
LVS04621	Linery LGYE horizontal joint 2500A	G-2
LVS04623	Linery LGYE horizontal joint 4000A	G-2
LVS04624	Linery LGYE isolating screen neutral	G-2
LVS04634	Connection 1000A 5mm hz.Bar/ LGY profile	G-4
LVS04635	Connection 1600A 5mm hz.Bar/ LGY profile	G-4, G-7, G-8
LVS04636	Connect.1600A 10mm hz bar/ LGY v.Profile	E-13, E-19, G-4, G-6, G-7, G-8, G-37
LVS04642	Mounting hardware/joint>80mm Linery LGY	G-4, G-6, G-7, G-8
LVS04637	Connect.Plate 3200A 10mm hz/ v.Flat bar	E-7, G-6
LVS04642	Mounting hardware/joint>80mm Linery LGY	G-6
LVS04638	Connect.Plate 4000A 10mm hz/ v.Flat bar	G-4, G-6
LVS04638	#N/A	G-4
LVS04640	Joint for 50/60mm bar/Linery BS hz bbar	F-16, G-3
LVS04641	Joint for 80/100mm bar/Linery BS hz bar	F-16, G-3
LVS04642	Mounting hardware/joint>80mm Linery LGY	E-7
LVS04643	Joint for 120mm bar/Linery BS hz.Busbar	G-3
LVS04645	20 Screw/joint 2x10mm Linery BS hz/v bb	G-6
LVS04651	Linery LGY lateral busbar support	G-4
LVS04652	Linery LGY rear busbar support	G-7
LVS04653	Linery BS rear vert.Support 5/10mm bar	G-8

Index Of Commercial References With Description

Com. no.	Description	Page	Com. no.	Description	Page
LVS04662	Free busbar support Linergy LGYE/BS		LVS04693	Conn.Sup.70mm b/centres	E-10, E-11, E-15, E-16
LVS04669	Wedge, Linergy BS, for busbar support	G-8	LVS04694	Conn.Sup 115mm b/centres	E-2, E-4, E-6, E-14, E-39
LVS04656	Linergy TB pen kit / LGY profile	G-37	LVS04703	Canalis interface 1600A 3P	E-11, E-16
LVS04657	Linergy TB 3 flat bar supp.For vert.Pe	G-37	LVS04704	Canalis interface 1600A 4P	E-11, E-16
LVS04658	12 Stops/1600A bott.Support Linergy LGYE	G-5	LVS04711	Canalis conn.Front NS-NT 3P	E-11, E-16
LVS04659	12 Stops/4000A bott.Support Linergy LGYE	G-5	LVS04712	Canalis conn.Front NS-NT 4P	E-11, E-16
LVS04661	Fixed support vert. Bb Linergy LGYE/BS	G-5, G-6	LVS04713	Canalis conn.Rear NS-NT 3P	E-11, E-16
LVS04646	Mounting hardware Linergy LGYEu3200A	G-5	LVS04714	Canalis conn.Rear NS-NT 4P	E-11, E-16
LVS04671	Additional mounting hardware	G-5, G-6	LVS04715	Canalis conn.1600A NW 3P	E-4
LVS04662	Free busbar support Linergy LGYE/BS	E-3, E-5, E-10, E-11, E-13, E-14, E-15, E-16, E-19, E-39, F-16, G-2, G-3, G-5, G-6	LVS04716	Canalis conn.1600A NW 4P	E-4
LVS04646	Mounting hardware Linergy LGYEu3200A	G-2, G-5	LVS04725	Canalis conn.2500A NW 3P	E-4
LVS04671	Additional mounting hardware	G-2, G-3, G-5, G-6	LVS04726	Canalis conn.2500A NW 4P	E-4
LVS04663	Bottom lat.V.5/10 Bb support lin. LGYE/BS	G-5, G-6	LVS04735	Canalis conn.3200A NW 3P	E-4
LVS04664	Fixed support hz. Bb Linergy LGYE/BS	F-16, G-2, G-3	LVS04736	Canalis conn.3200A NW 4P	E-4
LVS04646	Mounting hardware Linergy LGYEu3200A	G-2	LVS04742	Insulated flex.bar 20x2 L1800	G-20, G-21
LVS04665	Horiz.10Mm bb support D600 Linergy BS	G-2	LVS04743	Insulated flex.bar 20x3 L1800	G-20, G-21
LVS04666	Bot.Lat.5/10 Bb support W300 lin. LGYE/BS	G-5, G-6	LVS04746	Insulated flex.bar 24x5 L1800	G-20, G-21
LVS04661	Fixed support vert. Bb Linergy LGYE/BS	G-5, G-6	LVS04751	Insulated flex.bar 32x5 L1800	G-20, G-21
LVS04667	2 Horizontal pe supports Linergy TB	F-24, G-37	LVS04752	Insulated flex.bar 32x6 L1800	G-20, G-21
LVS04669	Wedge, Linergy BS, for busbar support	G-8	LVS04753	Insulated flex.bar 32x8 L1800	G-20, G-21
LVS04671	Additional mounting hardware	F-16, G-2, G-3	LVS04759	20 M8 torque nuts	G-13
LVS04672	2 Connect.Plate hz/v.Pe bar Linergy TB	G-37	LVS04766	20 M8 LGY bolts for cab.Lug/flex bar L25	G-13, G-37
LVS04678	Free 5/10 busbar support D600 Linergy BS	E-2, E-4, G-2	LVS04767	20 M8 LGY bolts for copper bar L39	G-13
LVS04683	Joint Linergy vert.LGY/LGYE 1600A 3P	E-3, E-5	LVS04768	Set of 12 screwplates for Linergy evolution 2500A	G-13
LVS04684	Joint Linergy vert.LGY/LGYE 1600A 4P	E-3, E-5	LVS04769	Set of 8 screwplates for Linergy evolution 4000A	G-13
LVS04685	Joint Linergy vertical LGYE 2500A NW	E-3, E-5	LVS04773	20 M8/diam.24 Flat washers flex. Bar/LGY	G-13
LVS04687	Joint Linergy vertical LGYE 3200A NW	E-3, E-5	LVS04774	20 M8/diam.28 Flat washers flex. Bar/LGY	G-13
LVS04690	Flange for flat bars	E-7	LVS04775	20 M8/diam.20 Flat washers lugs<25°/LGY	G-13
LVS04691	Flange for edgewise bars	E-10, E-13, E-15, E-19	LVS04782	20 Bolts 8.8 Class M8x20 /Linergy BS	G-6, G-13
LVS04692	Flange for flat bars W400	E-13, E-19	LVS04783	20 Bolts 8.8 Class M8x25 /Linergy BS	G-13
			LVS04784	22 Bolts 8.8 Class M8x30 /Linergy BS	G-13
			LVS04785	23 Bolts 8.8 Class M8x35 /Linergy BS	G-13
			LVS04786	24 Bolts 8.8 Class M8x40 /Linergy BS	G-13
			LVS04787	25 Bolts 8.8 Class M8x45 /Linergy BS	G-13
			LVS04788	26 Bolts 8.8 Class M8x50 /Linergy BS	G-13
			LVS04794	12 Phase marker/Linergy LGY/ LGYE profile	G-13
			LVS04809	Linergy FC tooth-caps	E-31, E-32, E-33, E-34, E-40, G-17
			LVS04810	Tooth-cap 1P Linergy FC D.BLK NSXm 160A	E-36, G-19

Index Of Commercial References With Description

Com. no.	Description	Page
LVS04842	Conn.Cover hz.Fix.NS1600	E-17
LVS04851	Front conn.Cover v.Fix.NS1600	E-15, E-16, H-4
LVS04852	Front conn.Cover v.NS1600-NT	E-10, E-11, E-15, E-16, H-4
LVS04853	Rear conn.Cov.V.Fix.NS1600	E-15, H-4
LVS04854	Rear conn.Cover v.NS1600-NT	E-10, E-11, E-15, E-16, H-4
LVS04855	Busbar cover v.NS1600-NT W400	E-13, E-19
LVS04860	Busbar cover v.NW/ISFL W650	E-7, E-58
LVS04861	Front connection cover NW	E-2, E-4, E-6, E-8, H-4
LVS04863	Rear connection cover NW	E-2, E-4, H-4
LVS04871	Canalis cover	H-4
LVS04901	Form 3 horizontal partition	H-6
LVS04911	Inter-cubicle partition D400	H-8
LVS04915	Plain barrier for bottom horizontal busbars	H-5
LVS04919	Plain barrier for bottom horizontal busbars	H-5
LVS04920	W300 fr.Barrier for lat.V.bb.	H-5
LVS04921	W150 fr.Barrier for lat.V.bb.	H-5
LVS04922	Form 2 side barrier for lat.Vert.bb.	H-5
LVS04924	Form 2 side barrier restoration kit	H-5
LVS04925	Partition conn.LGYE dev>800A W650 D600	H-4
LVS04926	Partition conn. Dev>800A W650 D600	E-10, E-11, E-14, E-15, E-16, E-39, H-4
LVS04927	Additional partition conn.W650 D600	E-3, E-5, E-14, H-4
LVS04928	Additional partition LGYE conn. W650 D600	E-3, H-4
LVS04931	Inter cubicle partition, PrismaSeT P	H-8
LVS04943	F3 partition rear support	H-6
LVS04946	F4 backplate front conn.D600	H-7
LVS04951	Form 4 cable gland plate 3/4 modules	H-7
LVS04952	Form 4 cable gland plate 5/6 modules	H-7
LVS04953	Form 4b cover transf.Connection 3/5m	H-7
LVS04954	Form 4b cover transf.Connection 4/6m	H-7
LVS04955	Form 3 rear conn. -Vert.Partition 3/4m	H-6
LVS04956	Form 3 rear conn. -Vert.Partition 5/6m	H-6
LVS04963	Form 2 cover horz.bb.4000A W300 D600	H-5
LVS04964	Form 2 cover horz.bb.4000A W400 D600	H-5
LVS04966	Form 2 cover horz.bb.4000A W650 D600	H-5

Com. no.	Description	Page
LVS04968	Form 2 cover horz.bb.4000A W800 D600	H-5
LVS04973	Form 2 cover horz.Busbar W300 D400	H-5
LVS04974	Form 2 cover horz.Busbar W400 D400	H-5
LVS04976	Form 2 cover horz.Busbar W650 D400	H-5
LVS04978	Form 2 cover horz.Busbar W800 D400	H-5
LVS04983	Form 2 cover horz.Busbar W300 D600	H-5
LVS04984	Form 2 cover horz.Busbar W400 D600	H-5
LVS04986	Form 2 cover horz.Busbar W650 D600	H-5
LVS04988	Form 2 cover horz.Busbar W800 D600	H-5

LVS07...

LVS07051	4 Cable connect.1P 160A 70mm ² Linergy BS	G-12
LVS07052	4 Cable conn.1P 250A 185mm ² Linergy BS	G-12
LVS07053	4 Cable connect1P 400A 300mm ² Linergy BS	G-12
LVS07931	Ral 7016 rotative handle PrismaSeT P Active/ PrismaSeT G Active	F-29
LVS07932	Euro rotative white handle PrismaSeT P Active/ PrismaSeT G Active	F-29
LVS07933	Assa rotative white handle PrismaSeT P Active/ PrismaSeT G Active	F-29
LVS07938	Handle padlocking kit for 1 locker	F-29
LVS07940	Barrel bloc with combination lock 405	F-29
LVS07941	Barrel bloc with combination lock 455	F-29
LVS07942	Barrel bloc with combination lock 1242e	F-29
LVS07943	Barrel bloc with combination lock 3113A	F-29
LVS07944	Barrel bloc with combination lock 2433A	F-29
LVS07945	Insert bloc combinaison.din double bar	F-29
LVS07946	Insert bloc combinaison. screwdriver slot	F-29
LVS07949	Insert bloc combi.8mm male triangle	F-29
LVS07951	Insert bloc combinaison.6mm male square	F-29
LVS07953	Insert bloc combinaison.8mm male square	F-29
LVS07956	Barrel bloc with combination lock 2432E	F-29

LVS08...

LVS08403	PrismaSeT P Active framework W300 D400	F-5, F-20
LVS08404	PrismaSeT P Active framework W400 D400	F-5, F-20

Index Of Commercial References With Description

Com. no.	Description	Page	Com. no.	Description	Page
LVS08406	PrismaSeT P Active framework W650 D400	F-2, F-3, F-4, F-5, F-20	LVS08576	IP30 cover frame W650	F-2, F-3, F-14
LVS08407	PrismaSeT P Active framework W650+150 D400	F-3, F-4, F-5	LVS08578	IP30 cover frame W800	F-3, F-14
LVS08408	PrismaSeT P Active framework W800 D400	F-5	LVS08585	Front plate hinge kit	F-22
LVS08433	IP30 plain roof W300 D400	F-15	LVS08593	IP30 door cut-out hsi W300	F-14
LVS08434	IP30 plain roof W400 D400	F-15	LVS08594	IP30 door cut-out hsi W400	F-14
LVS08436	IP30 plain roof W650 D400	F-2, F-3, F-4, F-15	LVS08603	PrismaSeT P Active framework W300 D600	F-2, F-5, F-20
LVS08438	IP30 plain roof W800 D400	F-3, F-4, F-15	LVS08604	PrismaSeT P Active framework W400 D600	F-5, F-20
LVS08456	IP55 plain roof W650 D400	F-4	LVS08606	PrismaSeT P Active framework W650 D600	F-2, F-4, F-5, F-20
LVS08458	IP55 plain roof W800 D400	F-4	LVS08607	PrismaSeT P Active framework W650+150 D600	F-2, F-4, F-5, F-20
LVS08476	IP30 ventilated roof W650 D400	F-32	LVS08608	PrismaSeT P Active framework W800 D600	F-5
LVS08478	IP55 ventilated roof W800 D400	E-61, F-32	LVS08633	IP30 plain roof W300 D600	F-2, F-15
LVS08483	IP55 plain gl.pl.W300 D400	F-19	LVS08634	IP30 plain roof W400 D600	F-15
LVS08484	IP55 plain gl.pl.W400 D400	F-19	LVS08636	IP30 plain roof W650 D600	F-2, F-4, F-15
LVS08486	IP55 plain gl.pl.W650 D400	F-2, F-3, F-4, F-19	LVS08638	IP30 plain roof W800 D600	F-2, F-4, F-15
LVS08487	IP55 plain gl.pl.W650+150 D400	F-3, F-4, F-19	LVS08640	PrismaSeT P Active Green Cover W300	F-2, F-15
LVS08488	IP55 plain gl.pl.W800 D400	F-19	LVS08641	PrismaSeT P Active Green Cover W400	F-15
LVS08493	IP30 2-part gl.pl.W300 D400	F-19	LVS08642	PrismaSeT P Active Green Cover W650	F-4, F-15
LVS08494	IP30 2-part gl.pl.W400 D400	F-19	LVS08643	PrismaSeT P Active Green Cover W800	F-2, F-3, F-15
LVS08496	IP30 2-part gl.pl.W650 D400	F-19	LVS08656	IP55 plain roof W650 D600	F-4
LVS08497	IP30 2-part gl.pl.W650+150 D400	F-19	LVS08658	IP55 plain roof W800 D600	F-4
LVS08498	IP30 2-part gl.pl.W800 D400	F-19	LVS08676	IP55 ventilated roof W650 D600	F-32
LVS08513	IP30 plain door W300	F-2, F-14	LVS08678	IP55 ventilated roof W800 D600	E-61, F-32
LVS08514	IP30 plain door W400	F-14	LVS08683	IP55 plain gl.pl.W300 D600	F-2, F-19
LVS08516	IP30 plain door W650	F-3, F-4, F-14	LVS08684	IP55 plain gl.pl.W400 D600	F-19
LVS08518	IP30 plain door W800	F-3, F-4, F-14	LVS08686	IP55 plain gl.pl.W650 D600	F-2, F-4, F-19
LVS08523	IP55 plain door W300	F-17	LVS08687	IP55 plain gl.pl.W650+150 D600	F-2, F-4, F-19
LVS08524	IP55 plain door W400	F-17	LVS08688	IP55 plain gl.pl.W800 D600	F-19
LVS08526	IP55 plain door W650	F-4, F-17	LVS08693	IP30 2-part gl.pl.W300 D600	F-19
LVS08528	IP55 plain door W800	F-4, F-17	LVS08694	IP30 2-part gl.pl.W400 D600	F-19
LVS08534	IP30 transparent door W400	F-14	LVS08696	IP30 2-part gl.pl.W650 D600	F-19
LVS08536	IP30 transparent door W650	F-2, F-4, F-14	LVS08697	IP30 2-part gl.pl.W650+150D600	F-19
LVS08538	IP30 transparent door W800	F-2, F-4, F-14	LVS08698	IP30 2-part gl.pl.W800 D600	F-19
LVS08544	IP55 transparent door W400	F-17	LVS08700	4 Lifting rings	F-21
LVS08546	IP55 transparent door W650	F-4, F-17	LVS08701	Stabiliser kit	F-21
LVS08548	IP55 transparent door W800	F-4, F-17	LVS08702	Levelling kit	F-21
LVS08560	10M hinged front.Plate sup. Kit W650	E-8, F-5, F-22	LVS08703	False floor fixing kit	F-21
LVS08562	12M hinged front plate sup. Frame W650	E-8, E-9, F-5, F-22	LVS08704	Floor/wall fixing kit	F-21
LVS08564	Hinged fr.Plate sup.Frame W400	F-5, F-22	LVS08706	Handl. Plinth lh. 2000->2550	F-20, J-13
LVS08566	Hinged fr.Plate sup.Frame W650	F-2, F-3, F-4, F-5, F-22	LVS08710	Reinforcement bracket PrismaSeT P Active seismic	F-20
LVS08574	IP30 cover frame W400	F-14	LVS08711	IP31 sealing kit	F-15
			LVS08712	LGYE Corner Kit for 90 Deg Installed Panel	F-16

Index Of Commercial References With Description

Com. no.	Description	Page
LVS08713	IP30 CORNER KIT FOR LINERGY BS	F-16
LVS08714	2 Side parts handl.Plinth D400	F-20, J-13
LVS08716	2 Side parts handl.Plinth D600	F-20, J-13
LVS08717	Side/side combi.IP55 seal.Kit	F-4, F-6, I-6
LVS08718	10 Combination screws+acc.	F-6
LVS08719	Double depth combination kit	F-3, F-4, F-6
LVS08720	2 Side plates for plinth D400	F-19
LVS08721	2 Side plates for plinth D600	F-19
LVS08722	Combination kit for lifting	F-20, J-13
LVS08723	Plinth h100 W300 D400	F-19
LVS08724	Plinth h100 W400 D400	F-19
LVS08726	Plinth h100 W650 D400	F-19
LVS08728	Plinth h100 W800 D400	F-19
LVS08733	IP30 rear panel W300	F-2, F-14
LVS08734	IP30 rear panel W400	F-14
LVS08736	IP30 rear panel W650	F-2, F-14
LVS08738	IP30 rear panel W800	E-61, F-2, F-14
LVS08743	Rear panel	F-17
LVS08744	Rear panel, PrismaSeT P, for enclosure W 400mm, IP55	F-17
LVS08746	Rear panel	F-17
LVS08748	IP55 rear panel W800	F-17
LVS08750	Set of 2 side panels D400	I-8
LVS08750D	PrismaSeT P Active Green Cover + Wireless Panel Server W400 +lateral panels D400	F-15
LVS08751D	PrismaSeT P Active Green Cover + Wireless Panel Server W650 +lateral panels D400	F-2, F-3, F-15
LVS08752D	PrismaSeT P Active Green Cover + Wireless Panel Server W800 +lateral panels D400	F-15
LVS08753	PrismaSeT P Active rear access side Panels D400	F-3, F-4, F-15
LVS08755	PrismaSeT P Active Green Cover + Wireless Panel Server W400 +lateral panels D400	F-20, I-8
LVS08755D	Set of 2 side panels D400	F-18
LVS08756	PrismaSeT P Active rear access side panels for L shape D400	F-15, F-18
LVS08756D	PrismaSeT P Active Green Cover + Wireless Panel Server W650 + lateral panels D400	F-18
LVS08757D	PrismaSeT P Active Green Cover + Wireless Panel Server W800 + lateral panels D400	F-18, F-20
LVS08760	Set of 2 side panels D600	I-8
LVS08760D	PrismaSeT P Active Green Cover + Wireless Panel Server W400 + lateral panels D600	F-15
LVS08761D	PrismaSeT P Active Green Cover + Wireless Panel Server W650 + lateral panels D600	F-2, F-15
LVS08762D	PrismaSeT P Active Green Cover + Wireless Panel Server W800 + lateral panels D600	F-4, F-15

Com. no.	Description	Page
LVS08763	PrismaSeT P Active rear access side Panels D400	F-4, F-18
LVS08765	Set of 2 side panels D600	F-20, I-8
LVS08765D	PrismaSeT P Active Green Cover + Wireless Panel Server W400 + lateral panels D600	F-18, F-20
LVS08766D	PrismaSeT P Active Green Cover + Wireless Panel Server W650 + lateral panels D600	F-18, F-20
LVS08767D	PrismaSeT P Active Green Cover + Wireless Panel Server W800 + lateral panels D600	F-4, F-18, F-20
LVS08773	4 Cable tie supports W300	F-20, F-28
LVS08774	4 Cable tie supports W400	E-13, F-20, F-28
LVS08776	4 Cable tie supports W650	F-28
LVS08778	4 Cable tie supports W800	F-28
LVS08783	Form c cable tie sup. L1600	F-28
LVS08794	4 Cable tie supports D400	E-13, E-19, F-26, F-28
LVS08796	4 Cable tie supports D600	E-13, E-19
LVS08796	4 Cable tie supports D600	F-28
LVS08900	Switchboard identification pl.	F-22
LVS08903	12 adhesive label holders 24x432	F-22
LVS08904	12 adhesive label holders 36x432	F-22
LVS08905	12 adhesive label holders 24x180 W300	F-22
LVS08906	12 adhesive label holders 36x180 W300	F-22
LVS08910	Earthing braid 6mm ²	F-22, F-29
LVS08911	Earthing wire 6mm ²	F-22, F-29
LVS08913	12 clip-on labels 18x35	F-22
LVS08914	12 engraving plates 18x35 / support 08913	F-22
LVS08915	12 clip-on labels 18x72	F-22
LVS08916	12 engraving plates 18x72 / support 08915	F-22
LVS08917	12 clip-on labels 25x85	F-22
LVS08918	12 engraving plates 25x85 / support 08917	F-22
LVS08921	20 Framework screws+wing nuts	F-6
LVS08961	Touch-up paint brush	F-22
LVS08963	Adhesive drawing holder	F-22
LVS08964	Switchboard lighting Syst G	F-35
LVS08965	Switchboard portable lamp	F-35
N...		
NSYCAC228RMB	Top hood roof with filterfan	E-61, F-32
NSYCAF92	Filter std G2 cut-out 92x92mm	F-30
NSYCAF125	Filter std G2 cut-out.125X125mm	F-30
NSYCAF125T	Fine filter G3 cut-out 125x125mm	F-30
NSYCAF223	Filter std G2 cut-out.223X223mm	F-30
NSYCAF223T	Fine filter G3 cut-out 223x223mm	F-30
NSYCAF228R	Filter for roof o.Grid 228x228mm	E-61
NSYCAF291	Filter std G2 cut-out.291X291mm	F-30
NSYCAF291T	Filter std G2 cut-out. 291x291mm	F-30

Index Of Commercial References With Description

Com. no.	Description	Page	Com. no.	Description	Page
NSYCAG92LPF	Outlet grille plast cut out 92x92mm	F-30	NSYTRAB620	Marking strip, Linergy TR, clip in type, 6mm	G-40
NSYCAG125LPF	Outlet grille plast cut out 125x125mm	F-30	NSYTRAB630	Marking strip, Linergy TR, clip in type, 6mm	G-40
NSYCAG291LPF	Outlet grille - plastic - cut out 291x291mm	E-61	NSYTRAB640	Marking strip, Linergy TR, clip in type, 6mm	G-40
NSYCAG223LPF	Outlet grille plast cut out 223x223mm	F-30	NSYTRAB690	Marking strip, Linergy TR, clip in type, 6mm	G-40
NSYCAG291LPF	Outlet grille - plastic - cut out 291x291mm	E-61, F-30	NSYTRAB5100	Marking strip, Linergy TR, clip in type, 5mm	G-40
NSYCAP125LE	EMC cover cut-out 125x125	F-30	NSYTRAB6100	Marking strip, Linergy TR, clip in type, 6mm	G-40
NSYCAP223LE	EMC cover cut-out 223x223	F-30	NSYTRAB51100	Marking strip, Linergy TR, clip in type, 5mm	G-40
NSYCAP291LE	EMC cover cut-out 291x291	F-30	NSYTRAB61100	Marking strip, Linergy TR, clip in type, 6mm	G-40
NSYCCASTE	Climasys CC - temperature range -30 to 80°C	F-34	NSYTRABF510	Marking strip, Linergy TR, clip in type, 5mm	G-40
NSYCCOHOY230VID	Climasys CC - electronic hygrostat - 200...240 V	F-34	NSYTRABF520	Marking strip, Linergy TR, clip in type, flat, 5mm	G-40
NSYCCOHYT230VID	Hygrotherm 230V	F-34	NSYTRABF530	Marking strip, Linergy TR, clip in type, flat, 5mm	G-40
NSYCCOTH230VID	Electronical thermostat 230V	F-34	NSYTRABF540	Marking strip, Linergy TR, clip in type, flat, 5mm	G-40
NSYCCOHD	Double thermostat(no nc) (°c)	F-34	NSYTRABF550	Marking strip, Linergy TR, clip in type, flat, 5mm	G-40
NSYCCOHI	Thermostat w/invers contact (°c)	F-34	NSYTRAC22	Cover plate, Linergy TR, 2 points, 2.2mm	G-40
NSYCR10WU2	ClimaSys PTC heating resistance 10W, 110-250V	F-33	NSYTRAC22BL	Cover plate, Linergy TR, 2 points, 2.2mm	G-40
NSYCR20WU2	ClimaSys PTC heating resistance 55W	F-33	NSYTRAC23	Cover plate, Linergy TR, 3 points, 2.2mm	G-40
NSYCR55WU2	ClimaSys PTC heating resistance 100W 110-250V	F-33	NSYTRAC24	Cover plate, Linergy TR, 4 points, 2.2mm	G-40
NSYCR100WU2	ClimaSys PTC heating resistance 100W 110-250V	F-33	NSYTRACE24	Cover plate, Linergy TR, 2 level, 2.2mm	G-40
NSYCR150WU2	ClimaSys PTC heating resistance 150W	F-33	NSYTRACE26	Cover plate, Linergy TR, 3 level, 2.2mm	G-40
NSYCR250W230VV	ClimaSys heating resistance ventil.250W	F-33	NSYTRACP43	Cover plate, Linergy TR, 2.2mm	G-40
NSYCR400W230VV	ClimaSys heating resistance ventil. 400W 230V aluminium	F-33	NSYTRACPE26	Cover plate, Linergy TR, 2.2mm width	G-40
NSYCRP1W230VTVC	ClimaSys PTC heating resistance 350-550W	F-33	NSYTRACR22	Cover plate, Linergy TR, 2.2mm	G-40
NSYCVF38M230PF	ClimaSys PTC heating resistance 350-550W	F-30	NSYTRACR22BL	Cover plate, Linergy TR, 2.2mm	G-40
NSYCVF85M230PF	ClimaSys forced vent. IP54, 85m3/h, 230V	F-30	NSYTRACR23	Cover plate, Linergy TR, 2.2mm	G-40
NSYCVF165M230PF	ClimaSys forced vent. IP54, 85m3/h, 230V	F-30	NSYTRACR23BL	Cover plate, Linergy TR, 2.2mm	G-40
NSYCVF300M230PF	ClimaSys forced vent. IP54, 300m3/h, 230V	F-30	NSYTRACR24	Cover plate, Linergy TR, 2.2mm	G-40
NSYCVF560M230PF	ClimaSys forced vent. IP54, 560m3/h, 230V	F-30, F-31	NSYTRACR24BL	Cover plate, Linergy TR, 2.2mm	G-40
NSYCVF575M230MB	ClimaSys forced vent. roof, 575m3/h, 230V	E-61, F-32	NSYTRACR42	Cover plate, Linergy TR, 2 points, 2.2mm	G-40
NSYCVF850M230PF	ClimaSys forced vent. IP54, 850m3/h, 230V	E-61, F-30, F-31	NSYTRACR43	Cover plate, Linergy TR, 3 points	G-40
NSYTRAB560	Marking strip, Linergy TR, clip in type, 5mm	G-40	NSYTRACRE24	Cover plate, Linergy TR, 2 level, 2.2mm	G-40
NSYTRAB570	Marking strip, Linergy TR, clip in type, 5mm	G-40	NSYTRACRE26	Cover plate, Linergy TR, 3 level, 2.2mm	G-40
NSYTRAB580	Marking strip, Linergy TR, clip in type, 5mm	G-40	NSYTRAL22	Plug-in bridge, Linergy TR, 2 points	G-40
NSYTRAB590	Marking strip, Linergy TR, clip in type, 5mm	G-40	NSYTRAL23	Plug-in bridge, Linergy TR, 3 points	G-40
NSYTRAB610	Marking strip, Linergy TR, clip in type, 6mm	G-40	NSYTRAL24	Plug-in bridge, Linergy TR, 4 points	G-40

Index Of Commercial References With Description

Com. no.	Description	Page
NSYTRAL25	Plug-in bridge, Linergy TR, 5 points	G-40
NSYTRAL42	Plug-in bridge, Linergy TR, 2 points	G-40
NSYTRAL43	Plug-in bridge, Linergy TR, 3 pole	G-40
NSYTRAL44	Plug-in bridge, Linergy TR, 4 pole	G-40
NSYTRAL45	Plug-in bridge, Linergy TR, 5 points	G-40
NSYTRAL210	Plug-in bridge, Linergy TR, 10 points	G-40
NSYTRAL210BL	Plug-in bridge, Linergy TR, 10 points	G-40
NSYTRAL210GR	Plug-in bridge, Linergy TR, 10 points	G-40
NSYTRAL220	Plug-in bridge, Linergy TR, 2 points	G-40
NSYTRAL410	Plug-in bridge, Linergy TR, 10 points	G-40
NSYTRAL410BL	Plug-in bridge, Linergy TR, 10 points	G-40
NSYTRAL410GR	Plug-in bridge, Linergy TR, 10 points	G-40
NSYTRAL420	Plug-in bridge, Linergy TR, 2 points	G-40
NSYTRP22	Terminal block, Linergy TR	G-40
NSYTRP22AR	Terminal block, Linergy TR, push-in type	G-40
NSYTRP22BL	Terminal block, Linergy TR, push-in type	G-40
NSYTRP23	Terminal block, Linergy TR	G-40
NSYTRP23AR	Terminal block, Linergy TR	G-40
NSYTRP23BL	Terminal block, Linergy TR, 2.5mm ²	G-40
NSYTRP24	Terminal block, Linergy TR, 2.5mm ²	G-40
NSYTRP24BL	Terminal block, Linergy TR, 2.5mm ²	G-40
NSYTRP24D	Terminal block, Linergy TR, 2.5mm ²	G-40
NSYTRP24DBL	Terminal block, Linergy TR, 2.5mm ²	G-40
NSYTRP26T	Terminal block, Linergy TR, 2.5mm ²	G-40
NSYTRP26TBL	Terminal block, Linergy TR, 2.5mm ²	G-40
NSYTRP42	Terminal block, Linergy TR, 4mm ²	G-40
NSYTRP42BL	Terminal block, Linergy TR, 4mm ²	G-40
NSYTRP43	Terminal block, Linergy TR, 4mm ²	G-40
NSYTRP43BL	Terminal block, Linergy TR, 4mm ²	G-40
NSYTRR22	Terminal block, Linergy TR, 2.5mm ²	G-40
NSYTRR22AR	Terminal block, Linergy TR, 2.5mm ²	G-40
NSYTRR22BL	Terminal block, Linergy TR, 2.5mm ²	G-40
NSYTRR22M	Terminal block, Linergy TR, 2.5mm ²	G-40

Com. no.	Description	Page
NSYTRR22MBL	Terminal block, Linergy TR, 2.5mm ²	G-40
NSYTRR22MF	Terminal block, Linergy TR, 2.5mm ²	G-40
NSYTRR22MFBL	Terminal block, Linergy TR, 2.5mm ²	G-40
NSYTRR22MFF	Terminal block, Linergy TR, 2.5mm ²	G-40
NSYTRR22MP	Terminal block, Linergy TR, 2.5mm ²	G-40
NSYTRR22MPBL	Terminal block, Linergy TR, 2.5mm ²	G-40
NSYTRR23	Terminal block, Linergy TR, 2.5mm ²	G-40
NSYTRR23AR	Terminal block, Linergy TR, 2.5mm ²	G-40
NSYTRR23BL	Terminal block, Linergy TR, 2.5mm ²	G-40
NSYTRR24	Terminal block, Linergy TR, 2.5mm ²	G-40
NSYTRR24BL	Terminal block, Linergy TR, 2.5mm ²	G-40
NSYTRR24D	Terminal block, Linergy TR, 2.5mm ²	G-40
NSYTRR24DBL	Terminal block, Linergy TR, 2.5mm ²	G-40
NSYTRR24M	Terminal block, Linergy TR, 2.5mm ²	G-40
NSYTRR24MBL	Terminal block, Linergy TR, 2.5mm ²	G-40
NSYTRR24MP	Terminal block, Linergy TR, 2.5mm ²	G-40
NSYTRR24MPBL	Terminal block, Linergy TR, 2.5mm ²	G-40
NSYTRR26T	Terminal block, Linergy TR, 2.5mm ²	G-40
NSYTRR26TBL	Terminal block, Linergy TR, 2.5mm ²	G-40
NSYTRR42	Terminal block, Linergy TR, 4mm ²	G-40
NSYTRR42AR	Screw terminal, feed through	G-40
NSYTRR42BL	Screw terminal, feed through	G-40
NSYTRR43	Terminal block, Linergy TR, 4mm ²	G-40
NSYTRR43BL	Terminal block, Linergy TR, 4mm ²	G-40
NSYTRV22	Screw terminal, feed through	G-40
NSYTRV22AR	Screw terminal, feed through	G-40
NSYTRV22BL	Screw terminal, feed through	G-40
NSYTRV22M	Screw terminal, feed through	G-40
NSYTRV22MBL	Screw terminal, feed through	G-40
NSYTRV23	Screw terminal, feed through	G-40
NSYTRV23BL	Screw terminal, feed through	G-40
NSYTRV24	Screw terminal, feed through	G-40
NSYTRV24BL	Screw terminal, feed through	G-40
NSYTRV24D	Screw terminal, feed through	G-40
NSYTRV24DBL	Screw terminal, feed through	G-40
NSYTRV26T	Screw terminal, 3 levels	G-40
NSYTRV26TBL	Screw terminal, 3 levels	G-40

Index Of Commercial References With Description

Com. no.	Description	Page
NSYTRV42	Screw terminal, feed through	G-40
NSYTRV42AR	Screw terminal, feed through	G-40
NSYTRV42BL	Screw terminal, feed through	G-40
NSYTRV42M	Screw terminal, feed through	G-40
NSYTRV42MBL	Screw terminal, feed through	G-40
NSYTRV43	Screw terminal, feed through	G-40
NSYTRV43BL	Screw terminal, feed through	G-40
NSYTRV44	Screw terminal, feed through	G-40

R...

R9XE110	Caps	G-34
R9XE210	Caps	G-34
R9XE310	Caps	G-34
R9XE410	Caps	G-34
R9XFC04	Connector	G-34
R9XFH112	Resi9 - comb busbar - 1L - 18 mm	G-34
R9XFH118	Resi9 - comb busbar - 1L - 18 mm	G-34
R9XFH157	Resi9 - comb busbar - 1L - 18 mm	G-34
R9XFH212	Resi9 - comb busbar - 1L+N - 18 mm	G-34
R9XFH218	Resi9 - comb busbar - 1L+N - 18 mm	G-34
R9XFH257	Resi9 - comb busbar - 1L+N - 18 mm	G-34
R9XFH312	Resi9 - comb busbar - 3L - 18 mm	G-34
R9XFH318	Resi9 - comb busbar - 3L - 18 mm	G-34
R9XFH357	Resi9 - comb busbar - 3L - 18 mm	G-34
R9XFH412	Resi9 - comb busbar - 3L+N - 18 mm	G-34
R9XFH418	Resi9 - comb busbar - 3L+N - 18 mm	G-34
R9XFH457	Resi9 - comb busbar - 3L+N - 18 mm	G-34
R9XFH518	Resi9 - comb busbar - 3L+N balanced - 18 mm	G-34
R9XFH518G	Resi9 - comb busbar - 3L+N balanced - 18 mm	G-34
R9XFH557	Resi9 - comb busbar - 3L+N balanced - 18 mm	G-34
R9XT20	Caps	G-34

S...

SMT10015	Antenna for wireless panel server	I-8
SMT10016	Power supply wiring harness for wireless panel server	I-8
SMT10019	Communication module	I-8

T...

TPSAUX32	Coupling auxiliary module	E-54, E-55
TPSAUX33	Coupling auxiliary module	E-54, E-55
TPSAUX43	Auxiliary contact, TransferPacT	E-56, E-57
TPSAUX44	Auxiliary contact, TransferPacT	E-56, E-57
TPSCON47	1.5 to 35 mm ² cable kit for TA25 3P	E-56
TPSCON48	1.5 to 35 mm ² cable kit for TA25 4P	E-56

Com. no.	Description	Page
TPSCON49	120 to 240 mm ² cable kit for TA25 3P	E-56
TPSCON50	120 to 240 mm ² cable kit for TA25 4P	E-56
TPSCON51	50 to 120 mm ² cable kit for TA25 3P,load	E-56
TPSCON52	50 to 120 mm ² cable kit for TA25 4P,load	E-56
TPSCON53	35 to 300 mm ² cable kit for TA63 3P	E-57
TPSCON54	35 to 300 mm ² cable kit for TA63 4P	E-57
TPSCON57	Lugs for copper cable, 240 mm ² , TA63, 3P	E-57
TPSCON58	Lugs for copper cable, 240 mm ² , TA63, 4P	E-57
TPSCON59	Lugs for copper cable, 300 mm ² , TA63, 3P	E-57
TPSCON60	Lugs for copper cable, 300 mm ² , TA63, 4P	E-57
TPSCON61	Aluminium cable lug, 240 mm ² , TA63, 3P	E-57
TPSCON62	Aluminium cable lug, 240 mm ² , TA63, 4P	E-57
TPSCON63	Aluminium cable lug, 300 mm ² , TA63, 3P	E-57
TPSCON64	Aluminium cable lug, 300 mm ² , TA63, 4P	E-57
TPSIS042	Long terminal shield, TransferPacT	E-57
TPSIS066	Insulating Shield, TransferPacT, 250 Amp Frame	E-56
TPSIS067	Insulating screen, TransferPacT, frame 630A	E-57
TPSISO30	Long Terminal Shields	E-54
TPSISO31	Long Terminal Shields	E-55
TPSISO65	Interface barrier	E-57

X...

XB5PRJ45	Panel mounted RJ45 port, Harmony XB5	G-35
XB5USB3	Panel mounted USB 3.0 port, Harmony XB5	G-35

Z...

ZBSP1	Protection cover, Harmony XB5	G-35
ZBSP2	Protection cover, Harmony XB5	G-35
ZBSP3	Protection cover, Harmony XB5	G-35

Overview

Contents

PrismaSeT P Active - Reliable, Easily connected	B-2
EcoStruxure™ Facility Expert - Cloud software to improve operations efficiency	B-4
Wireless Sensor for Early Detection of Overheating Cables	B-11
PrismaSeT G, Pack 250 enclosures up to 630 A - IP30, IP40, IP41, IP43, IP55	B-14
PrismaSeT P Active cubicles up to 4000 A - IP30, IP31, IP55	B-15
The switchboard, central to the electrical installation	B-16
Original Manufacturer and Assembly Manufacturer: Both involved in tested assemblies	B-17
The main 10 functions of standard IEC 61439	B-18
Develop your business efficiency with our functional LV systems	B-20
Electrical switchboards up to 4000 A	B-22
PrismaSeT 6300 - LV Switchboards for harsh environments up to 4000 A	B-24
Solutions for continuity of service in electrical installations with PrismaSeT	B-25
Linergy offers you smart power network solutions for your switchboard.	B-26
Secure power distribution and monitoring solution for operating theatres	B-28

PrismaSeT P Active - Reliable, Easily connected



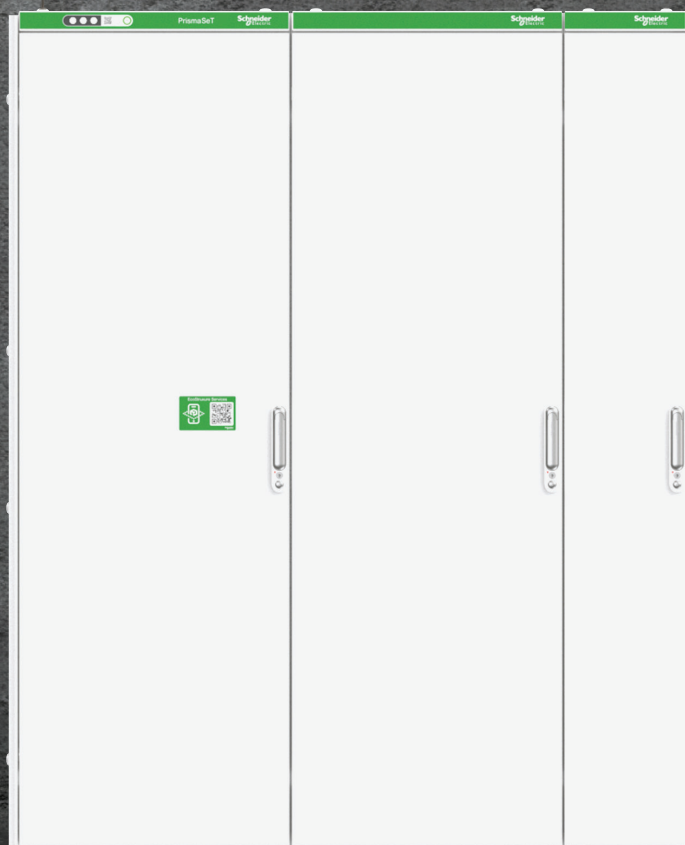

The new PrismaSeT P Active switchboard is the market forerunner with built-in cloud connectivity, allowing instant access to smart alarm system, energy usage analysis, trends, and preventative maintenance plans. Built-in cloud connectivity allows users to be notified of the round-the-clock electrical distribution as well as voltage loss if any. This maximizes efficiency and power availability, while creating the basis for future innovations. The PrismaSeT P Active switchboard also allows easy wireless integration of sensors.

Offer values

-  **Simplicity**
 - Deliver connectivity without any complexity
-  **Easy installation**
 - Simple-to-install connected solution
-  **Robustness and Design**
 - New design with new structure color, increased frame and door robustness
-  **Win more business**
 - Increase the service business opportunities while offering an affordable connected panel
-  **Protection**
 - Deliver greater peace of mind



Digital journey

-  **Peace of mind on the Cloud**
 - Electrical Fire Prevention
 - Power availability at no cost
 - Energy awareness
-  **Easy-to-install 100% wireless communication solutions**
 - User friendly installation instructions
 - Independent from customer IT
-  **Built-in connectivity**
 - Voltage loss alert free of charge
 - Connection to cloud in less than 5 min without any IT skill
-  **Easy installation and commissioning**
 - Less than 30 minutes for setting up the communication devices

PrismaSeT P Active - Reliable, Easily connected

New design with sustainable packaging

Enhance buildings with in-built connectivity and efficient design

The new design of PrismaSeT P Active increases the robustness of the panels, helps to gain efficiency on every level and provides peace of mind to the panel builders, electrical contractors and facility managers.

In addition, the new 100% green packaging decreases the quantity of waste and its disposal cost by using only cartons.

Green Packaging

- Progressive cancellation of plastic and polystyrene of packaging.
- 100% recyclable cardboards.
- Time & money saving to sort waste.
- New cross beam in cardboard for a more robust packaging.



Reinforced Frame

- Easier transportation and perception during assembly.
- Reinforcement on the lower angle levels using additional accessories.

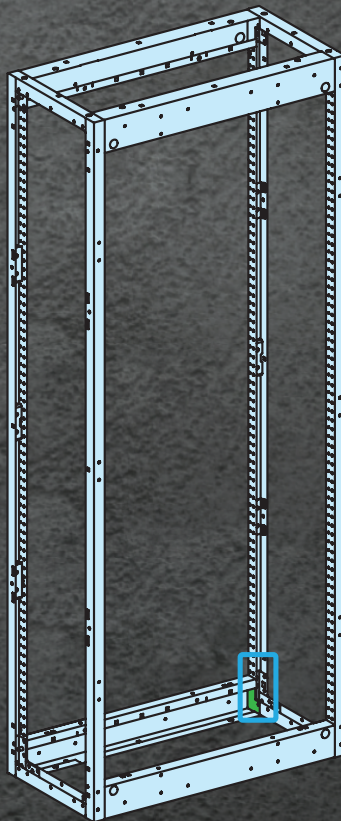

Reinforced Plain Door

- 3 hinges
- Sheet metal thickness 1.5 mm
- 20 x 20 bar reinforcement

IP 30/31 Plain Door

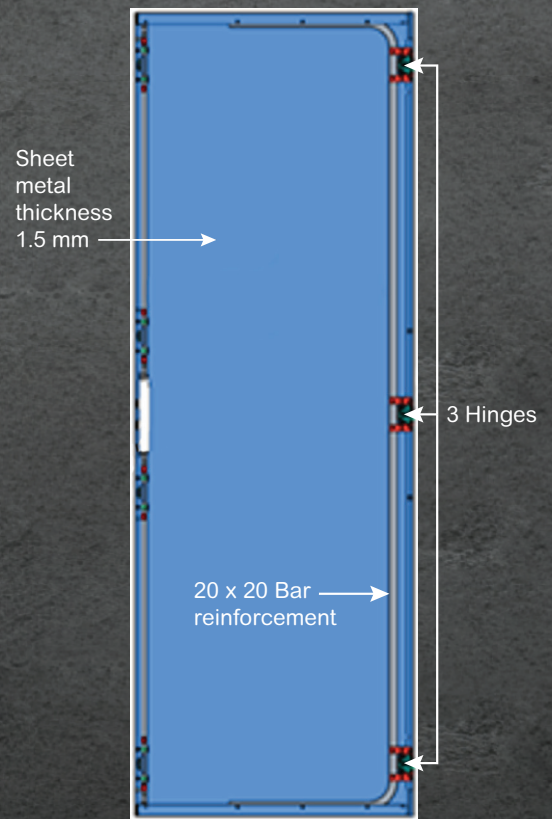

New Improved Handle

- More robust handle.
- Keyless entry door.
- Ergonomic and Aesthetically handle design.



Digital Instruction Sheets

- Cancellation of systematic printed instruction in each packaging.
- 1 printed 'Super Leaflet' with all instructions (available to order once).
- 1 systematic QR code to link to the right instruction sheets.

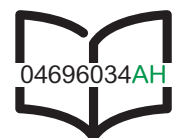

EcoStruxure™ Facility Expert

Cloud software to improve operations efficiency



Mobility to improve maintenance & operations

Register easily and overview all your assets status

QR code ready, Schneider Electric devices are already configured to communicate with EcoStruxure™ Facility Expert in a simple way and enable automatic download of ID, technical documentation and maintenance plan.

Located on the map, visualize all assets in real time, navigate and filter by area or status.

Remain connected and Informed

Providing relevant information on critical assets, sending instant and documented alarms EcoStruxure™ Facility Expert allows to diagnose remotely in case of issue and to manage maintenance efficiently.

- Instant alarms on threshold and status change
- Real-time assets status and map localization.
- Maintenance plan, asset log history, asset doc repository.
- Task manager and task reminder.
- 1 click to edit intervention and activity reports including voice memos, notes, photos and measurements.
- Remain connected, comment, share information and get support in the field from colleagues or experts if needed.



Web-application to monitor & analyze energy

EcoStruxure™ Facility Expert energy features give insights into energy data and provide visibility to reduce energy consumption.

On their web portal, Facility Managers get a clear vision on real time energy consumption for all managed buildings from any location.

- Main energy consumptions tracking (main, usage, zone, meter)
- Multi-site comparison capacity
- Cost monitoring
- Power demand and power factor monitoring
- Building performance: benchmarking against local energy performance scale (regulatory compliance to ISO50001, LEED, NABERS)
- Monthly score cards
- **Energy kiosk:** displayed on building public TV screens, this option shows your green image to visitors and promoters occupant ecofriendly behaviours.

Schneider Electric partners network

Schneider Electric local partners are trained and certified to sell, install and commission EcoStruxure™ Facility Expert. They can also operate the solution if the site manager wants to delegate this task.

For Commercial and Industrial application



- 1 Built-in wireless panel server
- 2 LED indicators: Phase status (on/off)
- 3 QR Code to activate your free alerts
- 4 EcoStruxure™ Facility Expert communication status indicator

- Service is activated on cloud-based software
- Service is not activated (blinking)



EcoStructure™ Facility Expert

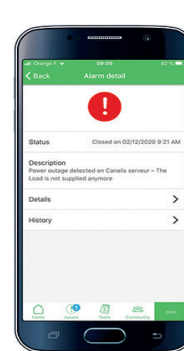

Alert detail

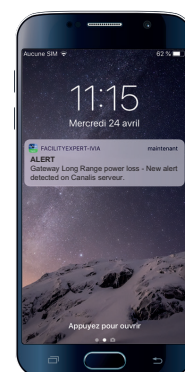

24/7 notifications on mobile devices

Note: The voltage presence indication of the Wireless Panel Server is only indicative and cannot replace all safety measures required before any intervention into the Low Voltage Switchboard



PrismaSeT Active wireless panel server installed into its environment

General Principle

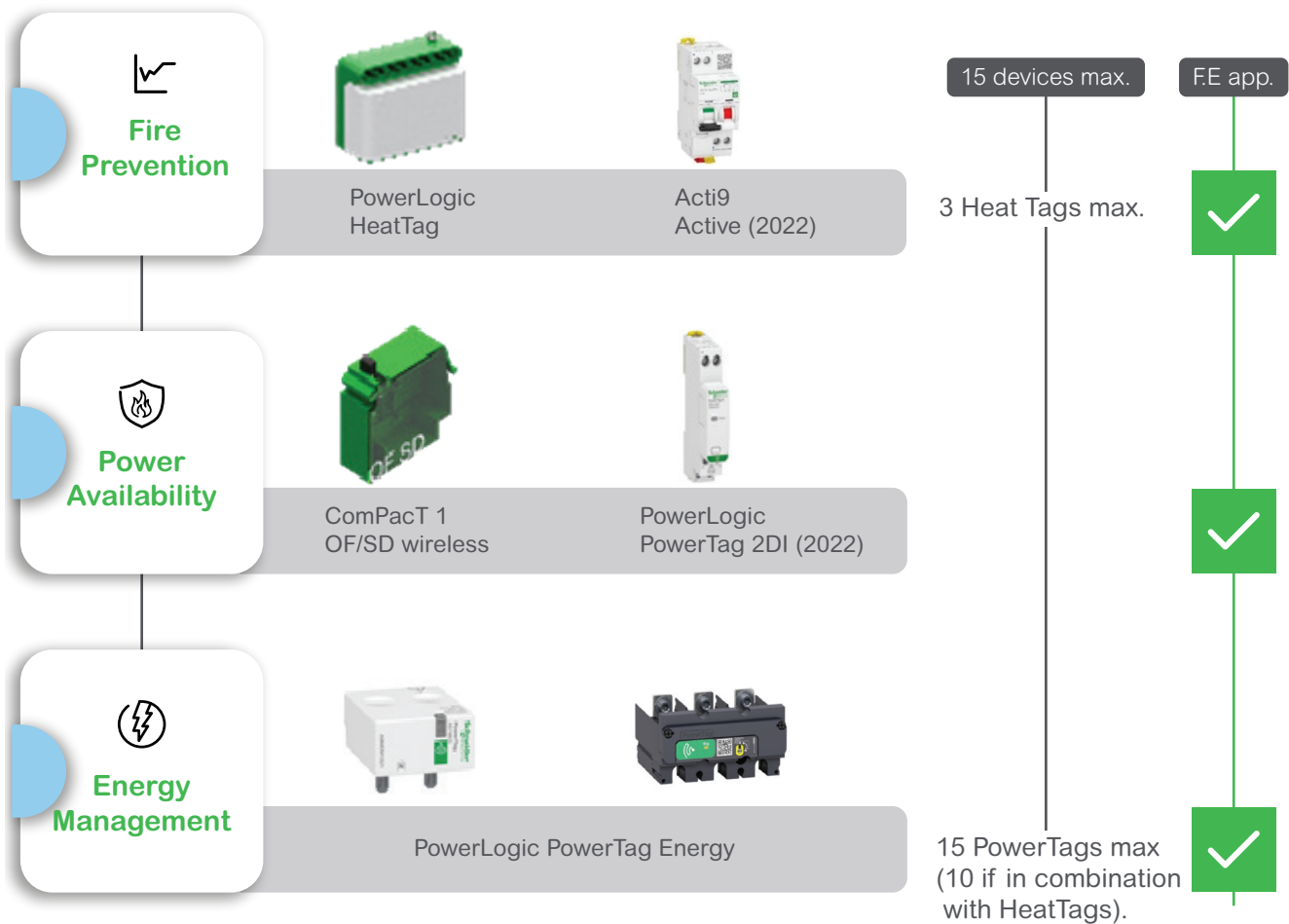

*Facility Expert Energy:

It is a Cloud software for energy efficiency. The app generates alarms when the consumption exceeds set targets while monitoring the energy consumption 24/7 with comparison by site or usage.

*Facility Expert Operation:

It is a cloud software for operation efficiency that alerts the user to optimize the maintenance procedures.

Main Features

LoRaWAN (Long Range Wide Area Network) is a networking protocol designed to connect wirelessly in order to assure end-to-end communication services.

The followings are the differentiating factors compared to other networking protocols:

- Long range coverage
- Low energy consumption
- Better penetration in buildings
- No SIM needed
- No additional fees to pay (included in Facility Expert subscription).

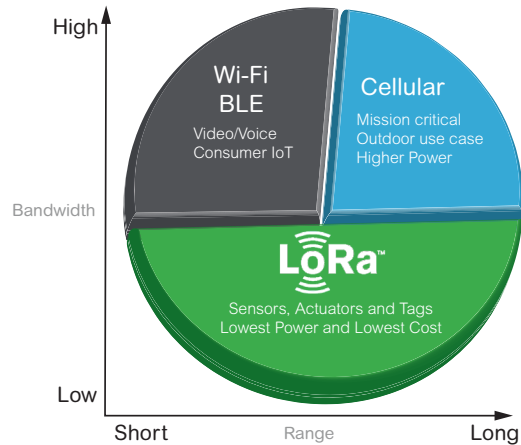

Simple 3-wire cable connections for ease of connectivity to Voltage Presence indicator.

QR code compatible for scanning through any device.

Free real time alarming in case of losing power.

Quick activation and subscription for the LoRa connection without paying any additional fees.

EcoStruxure Power Commission application simplifies sensor integration and commissioning (upto 15 Nos. under 30 mins).

Periodic report and updates.



Communication Architecture

	Name	Reference	Description
Applications	EcoStruxure Power Commission App	For free Play store/ Apple store	Easy wireless Panel and sensors Configuration
	EcoStruxure Facility Expert App	For free Play store/ Apple store	Reactive maintenance and Energy Management
Built-in Gateway	Wireless Panel Server built-in	Check page F 15	Built in PrismaSeT P
Alarming Sensors	HeatTag cable overheating sensor	SMT10020	Provide a proactive heating detection
	ComPacT NSX OF/SD auxiliary contact wireless	LV429454	Redefine and enhance customer experience with seamless connectivity
	ComPacT NSXm OF/SD auxiliary contact wireless	LV429453	Redefine and enhance customer experience with seamless connectivity
	Powertag C 2DI - 2 digital inputs 230 V for any default signal	A9XMC2D3	Provide a precise real time data on energy, currents, power, voltage and power factor.
	Arc Fault Detection Device with wirelelss communication	refer to Acti 9 catalog	Prevent arc fault reaching temperatures which can ignite home fires
PowerTag Energy Metering Sensors	PowerTag Energy Monoconnect 63A 1P+Wire	A9MEM1520	Provide precise, real-time data on energy, currents, power, voltage, and power factor
	PowerTag Energy Monoconnect 63A 1P+N top	A9MEM1521	
	PowerTag Energy Monoconnect 63A 1P+N bottom	A9MEM1522	
	PowerTag Energy Monoconnect 63A 3P top and bottom	A9MEM1540	
	PowerTag Energy Monoconnect 63A 3P+N top	A9MEM1541	
	PowerTag Energy Monoconnect 63A 3P+N bottom	A9MEM1542	
	PowerTag Energy Flex 63A 1P+N top and bottom	A9MEM1560	
	PowerTag Energy PhaseNeutral 63A 1P+N top	A9MEM1561	
	PowerTag Energy PhaseNeutral 63A 1P+N bottom	A9MEM1562	
	PowerTag Energy Flex 63A 3P+N top and bottom	A9MEM1570	
	PowerTag Energy PhaseNeutral 63A 3P+N top	A9MEM1571	
	PowerTag Energy PhaseNeutral 63A 3P+N bottom	A9MEM1572	
	PowerTag Energy Flex 160A 3P/3P+N	A9MEM1580	
	PowerTag Energy Monoconnect 250A 3P	LV434020	
	PowerTag Energy Monoconnect 630A 3P	LV434022	
	PowerTag Energy Monoconnect 250A 3P+N	LV434021	
	PowerTag Energy Monoconnect 630A 3P+N	LV434023	
	PowerTag Energy Rope 200A 3P/3P+N	A9MEM1590	
PowerTag Energy Rope 600A 3P/3P+N	A9MEM1591		
PowerTag Energy Rope 1000A 3P/3P+N	A9MEM1592		
PowerTag Energy Rope 2000A 3P/3P+N	A9MEM1593		
Communication Accessories	LoRa additional length for Antenna - 5 m	SMT10011	Improve the reception infront of the panel (if needed)
	LoRa Tester	SMT10013	Test the signal before and after installation
	LoRa /IP Plug & Play Bridge via SIM Card	SMT10024	In case of no reception of LoRa public network on your site

PowerLogic™ HeatTag sensor installed with Prisma**SeT** P Active Panel server and paired with EcoStructure™ Facility Expert

Prisma**SeT** P Active
Wireless Panel Server

PowerLogic™ HeatTag sensor

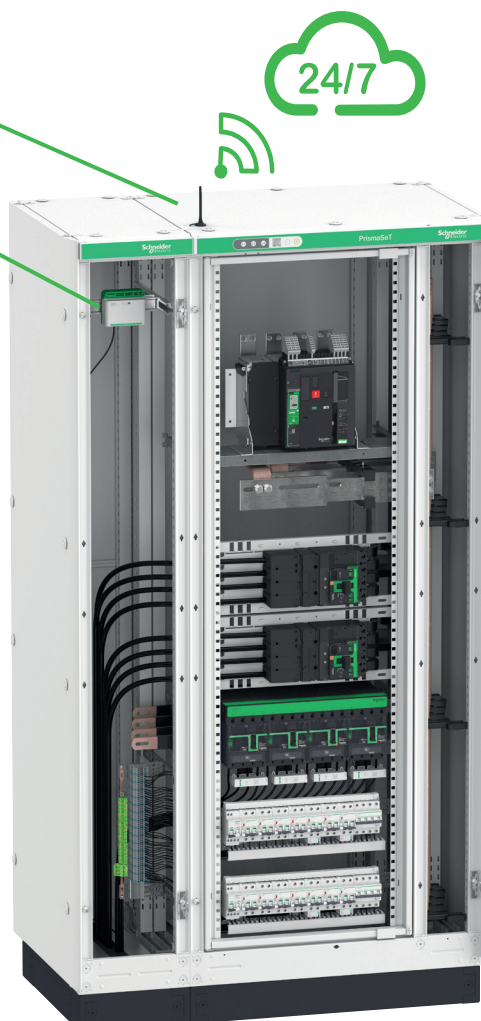

Easy to install: directly on a DIN rail in non-forced air-ventilated switchboards.

Easy to commission from your mobile with EcoStructure™ Power Commission.

B

PowerLogic™ HeatTag sensor installed with Prisma**SeT** P Active Panel server and paired with EcoStructure™ Facility Expert



EcoStructure™ Facility Expert

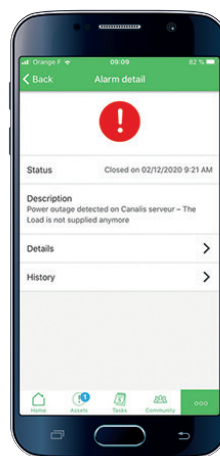

Alert detail

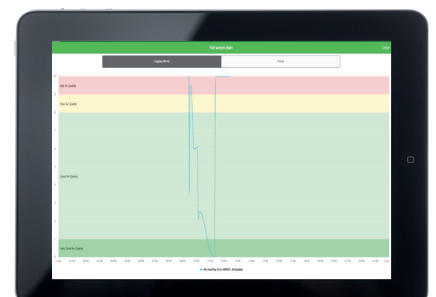

Cause and recommendations

Wireless Sensor for Early Detection of Overheating Cables



SMT10020

HeatTag is a smart sensor for early detection of overheating wire connections or overheating cables. HeatTag helps prevent electrical switchboards from being damaged, by analyzing gas and particles in the air and sending alerts before any smoke or insulator browning.

Standards

The HeatTag smart sensor complies with the following standards:

- IEC 61010-1:2017 UL/CSA/EU CENELEC deviations
- IEC/EN 61326-1b FCC Part 15B and 15C
- ETSI/EN 300328
- ETSI/EN 301489-1
- IEEE 802.15.4

Note:

Do not use HeatTag as a safety device. HeatTag does not replace the fire protection devices of the building.

Presentation

HeatTag smart sensor:

- Sends three levels of alert depending on the severity of the situation it detects.
- Helps prevent potential fire damages by analyzing gas and micro-particles emitted by cable sheaths when overheating.
- Measures temperature and humidity.
- Communicates with all Schneider Electric EcoStruxure panel servers or gateways.
- Is integrated in EcoStruxure solutions.

The HeatTag sensor must be installed only in non-forced air ventilated switchboards. It must be mounted on a DIN rail.

During the first 30 minutes after commissioning, HeatTag can generate an alert for test. It then takes another 8 hours for HeatTag to define its nominal environment and to be fully operational. Each time the HeatTag sensor is powered on, these 30-minute and 8-hour sequences are repeated.

Operation

Paired with Schneider Electric panel servers or gateways, HeatTag reports:

- Alerts
- Air quality index
- Temperature and humidity measurement
- Self-diagnosis information

Air Quality

HeatTag provides an air quality index, ranging from 0 to 10, and displays the air quality evolution trend in a table.

When the air quality index is equal or above 10, HeatTag sends an alert. It has detected abnormal cable sheath heating in the switchboard.

Detection Alert

An alert is triggered when HeatTag detects abnormal cable sheath heating in the switchboard, which can be caused by:

- One or more loose connections (too high contact resistance)
- A poorly sized cable compared to the rated current
- Overcurrent and poorly regulated protective equipment

Alerts are triggered with three severity levels:

- Low level: a cable is slowly overheating in the installation, you must plan a maintenance visit of the installation.
- Medium level: a cable is overheating in the installation, you must go quickly to the installation for maintenance.
- High level: a cable overheats very quickly, you must check the installation immediately.

The orange application led flashes when HeatTag sends an alert to the panel servers or gateways.

Temperature

HeatTag provides a temperature value with a 30 second default transmission period. The transmission period can be increased by the system in case of high wireless data traffic.

Humidity

The HeatTag provides a humidity rate with a 30 second default transmission period. The transmission period can be increased by the system in case of high wireless data traffic.

Self-Diagnosis

HeatTag carries out two types of diagnosis:

- A minor alert is sent when the fan rpm is 80% of its nominal rpm, which means fan clogging.
- A major alert is sent when HeatTag is faulty. In this case it cannot report measures at all, nor reports incorrect measures.

Wireless Sensor for Early Detection of Overheating Cables

HeatTag Smart Design

- No settings
- Nominal environment auto-learning to avoid false alerts
- Concentrator auto-discovery
- Alerts generated by a powerful algorithm integrated in HeatTag

Electrical Characteristics

Supply voltage	110-277 VAC, -15 % / +15 %
Frequency	50-60 Hz
Max. consumption	0.1 A
Operating temperature	-15 °C / +70 °C (5 °F to 158 °F)
Storage temperature	-20 °C / +85 °C (-4 °F to 185 °F)
Relative humidity in operation	15-90 %
Altitude of use	0-2000 m (0-6500 ft)
Degree of pollution (IEC 60664-1)	3
Overvoltage category	OVC III

Sensor Characteristics

Temperature measurement	Measurement range	-15 °C / +70 °C (5 °F to 158 °F)
	Measurement accuracy	-1.1 °C / +1.1 °C
	Default transmission period	30 seconds (higher in case of high wireless data traffic)
Humidity measurement	Measurement range	15-90 %
	Measurement accuracy	±9 RH %
	Default transmission period	30 seconds (higher in case of high wireless data traffic)
Air quality		Index (0 to 10), alert generation when index ≥ 10
Test alert after pairing		During the first 30 minutes
Environment auto-learning phase		8 hours after the first 30 minutes

Installation

Communication Architecture

List of compatible communicators:

- EcoStruxure Panel Servers
- PowerTag Link
- PrismaSeT Wireless Panel Server

Wiring

HeatTag must be protected by 2 A breaker. It is delivered with a separate connector.

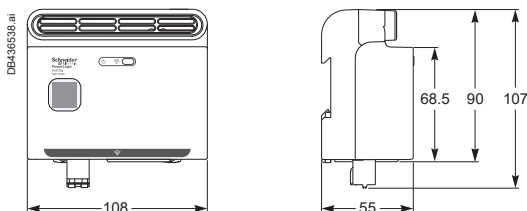
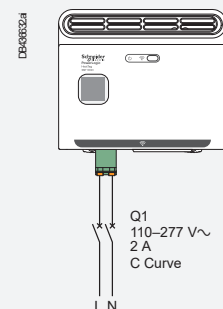

Mechanical Characteristics

Dimensions (w x h x d)	108 x 107 x 55 mm
Weight	270 g
Degree of protection (IEC 60529)	IP30

Wireless Sensor for Early Detection of Overheating Cables

Integration in PrismaSeT P Active

HeatTag must be installed following the Instruction Sheet recommendations (MFR5173801).

DB437105.ai

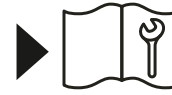

MFR5173801

B

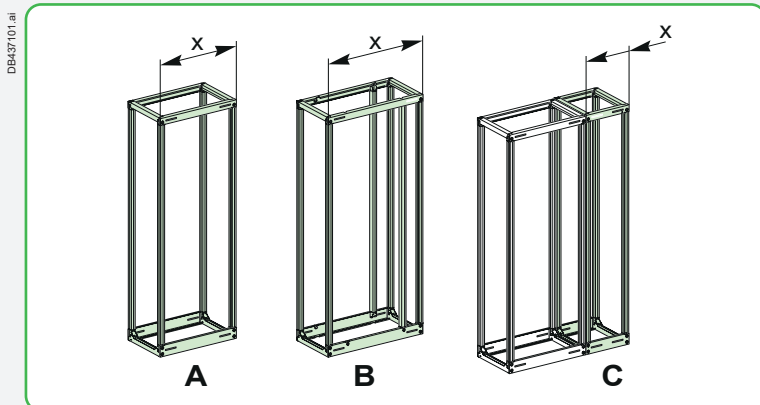

HeatTag must be installed on a DIN rail.

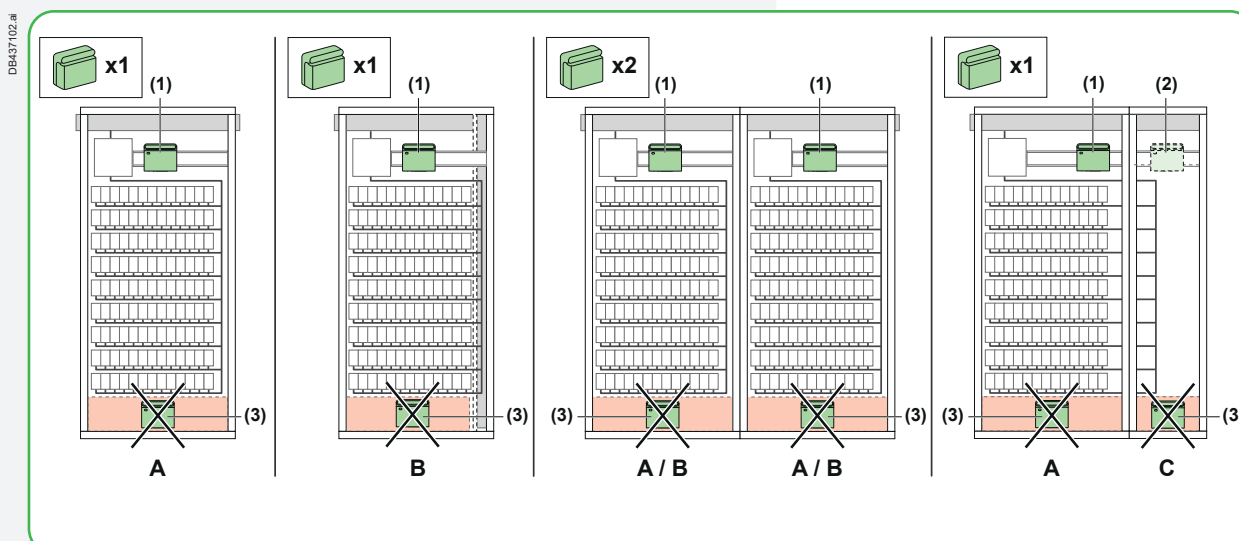
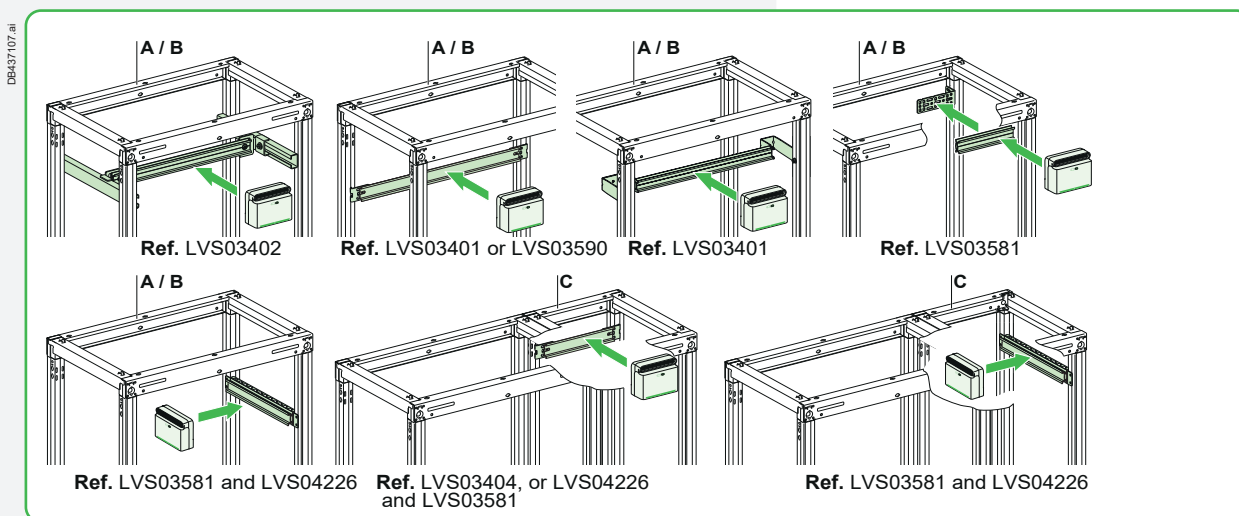

PrismaSeT G enclosures up to 630 A IP30, IP40, IP41, IP43, IP55



PB115624_28 eps

250 A

- Schools
- Small shops
- Hotels, etc.

PrismaSeT G Pack 250



- Small companies
- Buildings
- Offices
- Laboratories
- Healthcare centres
- Hotels
- Supermarkets
- Malls, etc.

630 A

PrismaSeT G Active



PrismaSeT P Active cubicles up to 4000 A IP30, IP31, IP55

The optimised, tested and IEC compliant solution, for low voltage electrical distribution and control switchboards.



4000 A

- Hospitals
- Data centres
- Logistics centres
- Shopping centres
- Offices buildings
- Medium industrial solutions

PrismaSeT P Active



The switchboard, central to the electrical installation

Both the point of arrival of energy and a device for distribution to the site applications, the LV switchboard is the intelligence of the system, central to the electrical installation.

It plays an essential role in the availability of electric power, while meeting the needs of personal and property safety. Its definition, design and installation are based on precise rules; there is no place for improvisation. The IEC 61439 standard aims to better define "low-voltage switchgear and controlgear assemblies", ensuring that the specified performances are reached. It specifies in particular:

- the responsibilities of each player, distinguishing those of the original equipment manufacturer; the organization that performed the original design and associated verification of an assembly in accordance with the standard, and of the assembly manufacturer - the organization taking responsibility for the finished assembly;
- the design and verification rules, constituting a benchmark for product certification.

All the component parts of the electrical switchboard are concerned by the IEC 61439 standard. Equipment produced in accordance with the requirements of this switchboard standard ensures the safety and reliability of the installation.

A switchboard must comply with the requirements of standard IEC 61439-1 and 2 to guarantee the safety and reliability of the installation. Managers of installations, fully aware of the professional and legal liabilities weighing on their company and on themselves, demand a high level of safety for the electrical installation.

What is more, the serious economic consequences of prolonged halts in production mean that the electrical switchboard must provide excellent continuity of service, whatever the operating conditions.

The Schneider Electric solution

- Specify switchboards that comply with standard IEC 61439-1 and 2.
- Guarantee a level of safety that has been 100 % tested, from the day the switchboard is installed and throughout its service life.
- Ensure a lasting investment through easy upgrading of the installation in compliance with the standard.
- Guarantee that the switchboard complies with the technical specifications.

PrismaSeT tested switchboards

The conformity of the switchboard has been tested and proven.

A PrismaSeT switchboard is:

- made up of Schneider Electric low-voltage devices and components that all comply with the applicable standards;
- based on configurations in our catalog;
- made up of PrismaSeT and Linergy mechanical and electrical components that have been subjected to the verification of original equipment manufacturer;
- mounted and wired by a panelbuilder in compliance with professional standards;
- subjected to the individual verification.

Schneider Electric makes available to the panelbuilder everything required to create tested PrismaSeT switchboards, including the basic configurations in the low voltage distribution catalog, all the documentation for switchboard design and mounting, calculation and design software, etc.

Panelbuilders can demonstrate conformity with standard IEC 61439-1 and 2 by presenting the declarations or certificates of conformity for type tests carried out by independent laboratories (ASEFA, ASTA, etc.) and supplied by Schneider Electric. The panelbuilder is responsible for the individual routine verification and delivers the corresponding declarations of conformity.

Original Manufacturer and Assembly Manufacturer: Both involved in tested assemblies

Standard IEC 61439 clearly defines the type of verifications that must be conducted by both organisations involved in final conformity of the solution: the Original Manufacturer, guaranteeing assembly system design and the Assembly Manufacturer, responsible for the final conformity of the switchboard.

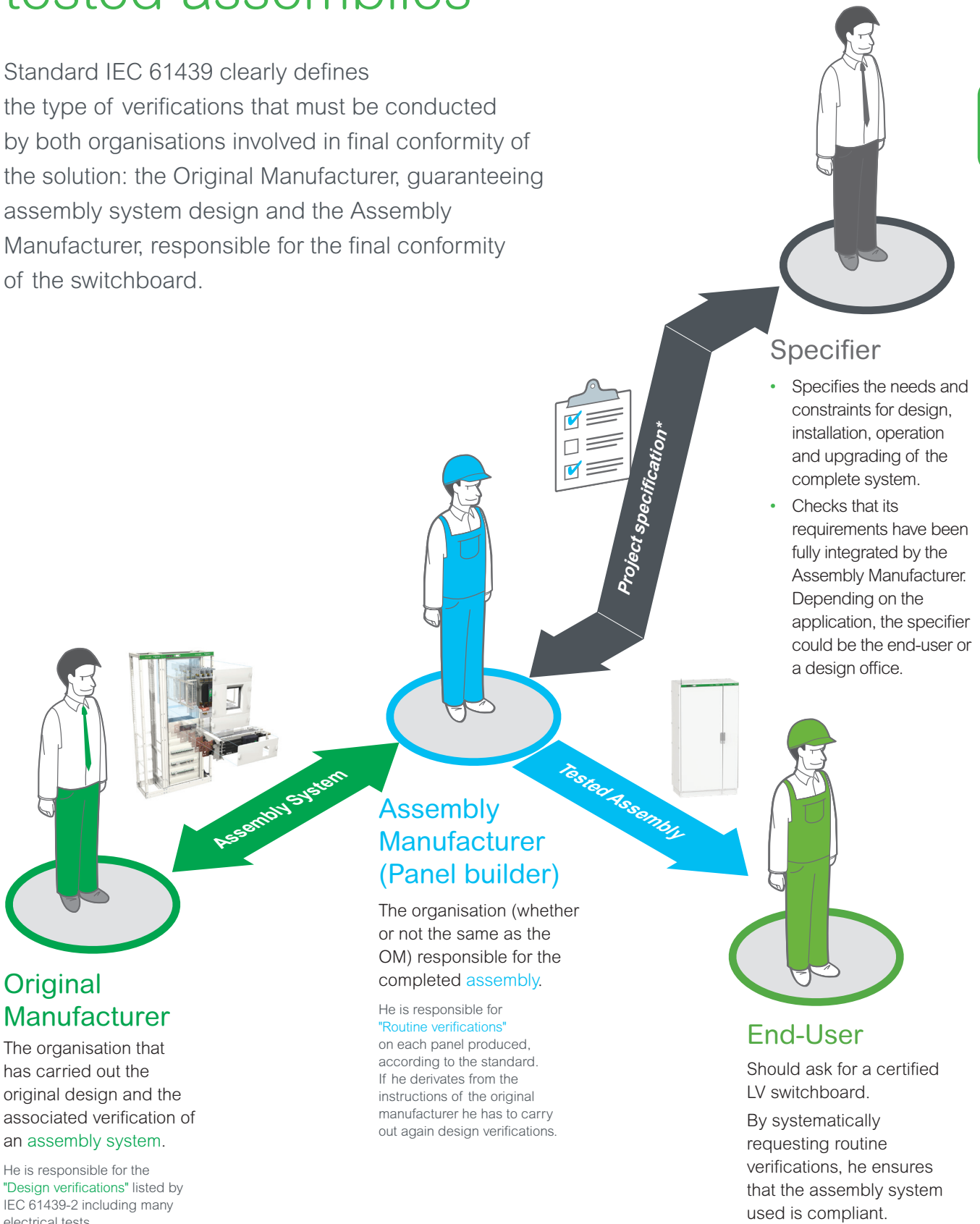

The main 10 functions of standard IEC 61439

For each of the following 10 functions, the standard IEC 61439 requires design verifications from the system manufacturer - mainly through type-tests - and routine verifications on each panel from the Panel Builder to achieve 3 basic goals: safety, continuity of service and compliance with end-user requirements.



Safety

Voltage stresses withstand capability

To withstand long term voltages, and transient and temporary overvoltages according to the insulation coordination principles and requirements.

Current-carrying capability

To protect against burns and to withstand temperature rise:

- when any circuit is continuously loaded, alone, to the specified current
- when the assembly is loaded to the specified current according to the specified load pattern (between circuits and/or as a function of the time).

Short-circuit withstand capability

To withstand the stresses resulting from the prospective short-circuit current and from the associated data (High forces between conductors, temp. rise in a very short time, air ionization, overpressure).

Protection against electric shock

- Hazardous-live-parts not to be accessible (basic protection)
- Accessible conductive parts not to become hazardous-live (fault protection).

Protection against risk of fire or explosion

- Resistance to internal glowing elements

Note: protection of persons, and optional protection of the assembly, against arcing due to internal fault can be specified through a "special test" according to IEC 61641.



Continuity of service

Maintenance and modification capability

Capability to preserve continuity of supply without impairing safety during assembly maintenance or modification

- Electrical condition of the assembly or various circuits
- Speed of exchange of the functional units
- Test facilities...

Electro-Magnetic compatibility

To properly function (immunity) and not to generate EM disturbances (emission) in specified environmental conditions:

- Industrial networks or locations (Environment A)
- Domestic, commercial, and light industrial locations (Environment B).



Compliance with end-user requirements

Capability to operate the electrical installation

To properly function, according to:

- The electrical diagram of the overall system and related information (voltages, coordination...)
- The specified operating facilities (e.g. free or restricted access to Man Machine Interfaces, isolation of the outgoing circuits...).

Capability to be installed on site

- To withstand handling, transport, storage... and installation constraints
- Capability to be erected and connected (type of enclosure, type, material and cross sectional areas of external conductors).

Protection of the assembly against mechanical and atmospheric environmental conditions

- Presence of water or solid foreign bodies (IP according to IEC 60529)
- External mechanical impacts (optional IK according to IEC 62262)
- Indoor or outdoor installation (humidity, UV).

IEC 61439-1 paragraph 11.4

Protection against electric shocks and integrity of protection circuits

The following should be checked visually:

- presence of protective shields against direct and indirect contacts on live parts;
- presence of the PE conductor.

The continuity of protection circuits is ensured by compliance with the assembly instructions delivered with each product.

IEC 61439-1 paragraph 11.5

Integration of incorporated components

The assembly manufacturer must comply with the instructions of the original equipment manufacturer for installation and wiring of the components used.

IEC 61439-1 paragraph 11.6

Internal electric circuits and connections

Schneider Electric recommends marking the nut with a tinted acrylic lacquer, indelible and temperature-resistant.

This allows:

- not only self-checking to check effective tightening to torque;
- but also identification of any loosening.

IEC 61439-1 paragraph 11.9

Dielectric properties

The main circuits, and the auxiliary and control circuits connected to the main circuit, shall be subjected to the test voltage in accordance.

IEC 61439-1 paragraph 11.10

Wiring, operating performance and function

Verification of wiring and marking conformity with the drawings, parts list and diagram.

Standard individual check sheet

in accordance with the IEC 61439-1 and 2 standard from the assembly manufacturer (panelbuilder)

B

Job No.:

Switchboard No.:

Drawing No./Rev. No.:

	Chapter	Verified
Degrees of protection provided by enclosures	11.2	<input type="checkbox"/>
Insulation clearances and creepage distances	11.3	<input type="checkbox"/>
Protection against electric shocks and integrity of protection circuits	11.4	<input type="checkbox"/>
Integration of incorporated components	11.5	<input type="checkbox"/>
Internal electric circuits and connections	11.6	<input type="checkbox"/>
Terminals for external conductors	11.7	<input type="checkbox"/>
Mechanical operation	11.8	<input type="checkbox"/>
Dielectric properties	11.9	<input type="checkbox"/>
Wiring, operating performance and function	11.10	<input type="checkbox"/>

Date of verification:

..... / /

Verifications performed by:

.....

Develop your business efficiency



Switchboards that are safe...

With PrismaSeT P Active you can be sure to build 100% Schneider Electric switchboards that are safe, optimised:

- All components (switchgear, distribution blocks, prefabricated connections, etc.) are perfectly rated and coordinated to work together.
- All switchboard configurations, even the most demanding ones, have been tested.

You can prove that your switchboard meets the current standards, at any time.

You can be sure to build a reliable electrical installation and give your customers full satisfaction in terms of dependability and safety for people and the installation.



Tested low voltage switchboard, IEC 61439-1&2 compliant.



- Available power
- Safety of people and property
- Controlled costs and delivery times
- Upgradeability

with our functional LV systems

... optimised and upgradeable

With PrismaSeT P Active you can build just the right switchboard for your customer, sized precisely to fit costs and needs. With this complete, prefabricated and tested system, it's easy to upgrade your installation and still maintain the original performance levels.

- The cubicles combine easily with switchboards already in service.
- Devices can be replaced or added at any time.



Straightforward organisation to make your job easier

The switchboard is structured by zones dedicated to switchgear, busbars, cables, etc.

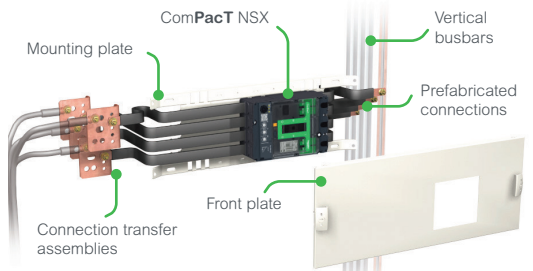

The functional units are naturally stacking in the switchboard.

Each configuration is tested for improved safety.



Temperature rise test in laboratory.

Readily available close by

The kit concept makes handling and transport easier and you get to benefit from Schneider Electric's efficient international logistics. Your distributor, selected by Schneider Electric, can give you the very best advice.

Electrical switchboards up to 4000 A

The PrismaSeT P Active functional system can be used for all types of low-voltage distribution switchboards (main, subdistribution and final) up to 4000 A, in commercial and industrial environments.

Configurations6 - v2.png

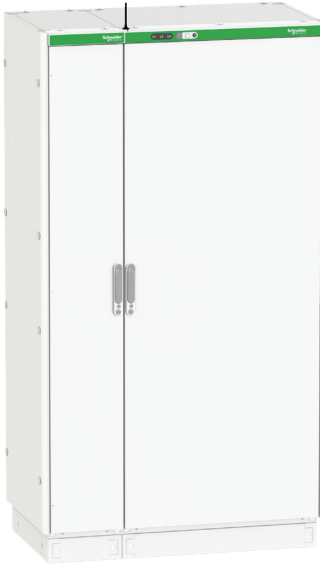

PD390150_SE_R_eps

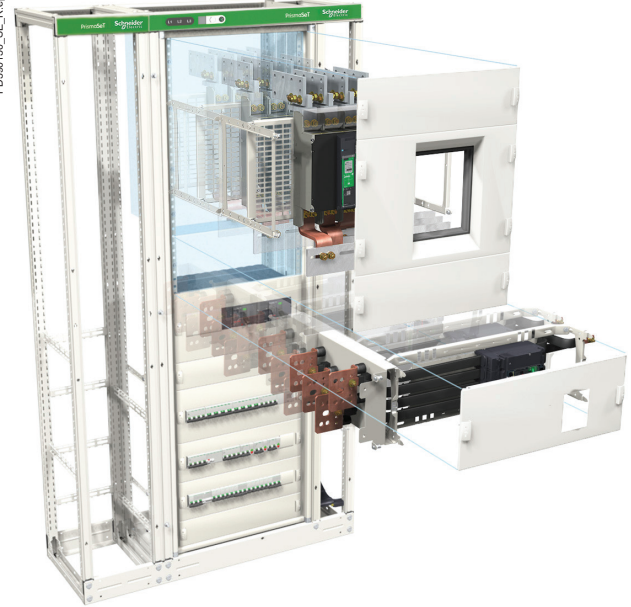

Switchboard design is very simple

1. A metal structure

The switchboard is made up of one or more frameworks combined side-by-side or back-to-back, on which a complete selection of cover panels and doors can be mounted.

2. A distribution system

Horizontal busbars or vertical busbars positioned in a lateral compartment or at the rear of the cubicle are used to distribute electricity throughout the switchboard.

3. Complete functional units

- a dedicated mounting plate for device installation
- a front plate to block direct access to live parts
- prefabricated busbar connections
- devices for on-site connections.

Each functional unit contributes to a function in the switchboard.

The functional units are modular and are arranged rationally.

The system includes everything required for functional unit mounting, supply and onsite connection.

The components of the PrismaSeT P Active and those of the functional units in particular have been designed and tested taking into account device characteristics.

This design approach ensures a high degree of reliability in system operation and optimum safety for personnel.



Assets of switchboards

1. A dependable electrical installation

The total compatibility of Schneider Electric devices with the PrismaSeT P Active is a key advantage in ensuring a high level of installation dependability.

2. An upgradeable electrical installation

Thanks to modular design, PrismaSeT P Active switchboards can be modified easily to integrate new functional units as needed. Maintenance operations, carried out with the switchboard de-energised, are fast and straight-forward due to easy access to devices.

3. Total safety for personnel

Work in a switchboard must be carried out by authorised persons in compliance with all applicable safety regulations.

To increase the safety of personnel, devices are installed behind protective front plates; only the operating handles are accessible.

Additional internal protection (partitions, barriers) is available to create form 2, 3 or 4 separation to protect against direct contacts with live parts.

Terminal shields are mandatory for installation of ComPacT NSX and INS/INV devices in PrismaSeT P Active enclosures.

4. Connected solutions

- Fire prevention
- Power availability
- Energy Management

Electrical switchboards up to 4000 A

System design has been validated by type tests as per standards IEC 61439-1 and 2 and benefits from the combined experience of Schneider Electric customers over many years.

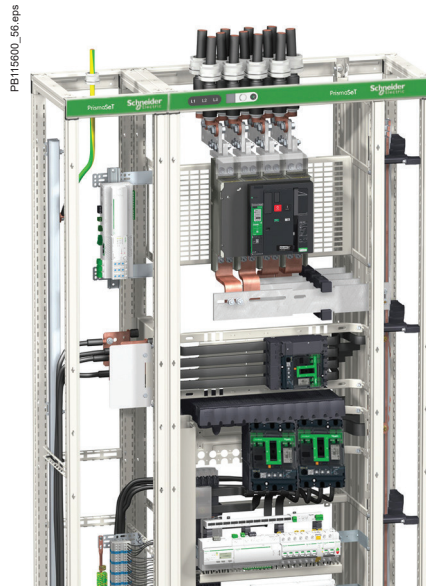

B



Electrical characteristics

Complying with standards IEC 62208 and EN 62208:

- rated insulation level of main busbars: 1000 V
- InA : 4000 A
- rated peak withstand current Ipk: 220 kA
- rated short-time withstand current Icw: 100 kA rms / 1 second
- frequency: 50/60 Hz
- voltage Ue = 690 V under conditions



Mechanical characteristics

- Steel sheet metal
- Cathaphoresis treatment + hot-polymerised polyester epoxy powder, white colour RAL 9003
- Can be dismantled
- Can be combined side-by-side and back-to-back
- Degree of protection:
 - IP30: with IP30 cover panels including a door or a cover frame
 - IP31: with IP30 cover panels including a door + gasket
 - IP55: with IP55 cover panels
- Degree of protection against mechanical impacts:
 - IK07: with cover frame
 - IK08: with IP30 door
 - IK10: with IP55 door
- Framework dimensions:
 - four widths:
 - W = 300: cable compartment
 - W = 400: cable compartment or device compartment
 - W = 650: device compartment or cable compartment
 - W = 800: device compartment with busbar compartment or cable compartment
 - two depths: 400, 600 mm
 - height: 2000 mm.
- Indoor cubicles.



See "How to assemble an electrical switchboard" Guide DESW043EN



Electrical switchboards built using the PrismaSeT P Active functional system and Schneider Electric recommendations fully comply with international standards IEC 61439-1 and 2.

PrismaSeT 6300 - LV switchboards for harsh environments up to 4000 A

When demanding applications and severe conditions require the best, assure your success with PrismaSeT 6300.



Technical characteristics

- High grade steel, durable epoxy painting techniques and ingenious design for a remarkable robustness.
- Steel sheet metal, thickness 1.5 mm on panels and 1.8 mm on doors.
- Electrophoresis treatment and hot-polymerised polyester epoxy powder.
- White color RAL 9003.
- Degree of protection: IP55 (IEC 60529).
- Degree of protection against mechanical impacts: IK10 with door (IEC 62262).
- Frame dimensions:
 - 2 widths:
 - 700 mm (for functional units)
 - 300 mm (for vertical busbars and cables ducts)
 - 2 depths:
 - 500 mm (up to 1600 A)
 - 800 mm (up to 4000 A)
 - height: 2000 mm.



Reinforced solution for low voltage switchboards up to 4000 A

More than PrismaSeT, PrismaSeT 6300 contributes to safety of persons as well as to reliability and continuity of service of the electrical installation. Thanks to its reinforced metal structure, it combines outstanding robustness with versatility and flexibility, by resisting to harsh environments and heavy loads. PrismaSeT PH is ready to perform in any condition.

As PrismaSeT, PrismaSeT PH is a solution of kit cubicles for low voltage electrical distribution switchboards:

- the components (switchgear, busbars, etc.) are designed for joint operation
- all the most demanding switchboard configurations have been tested and are IEC standard compliant.



Total safety and reliability

PrismaSeT 6300 is designed to operate up to 4000 A.

It is fully tested to perform in extreme conditions, and fully compliant with standards IEC 61439-1 and 2, IEC 62208.

PrismaSeT 6300 withstands seismic vibrations (Standard EDF CRT91C11200, AS1170, EAK 2000, ENDESA 1986, RPA 99 2003, Gore GR 63, Turkish Seismic Code, GOST 17516.1-90).

Seismic tests are performed by an external laboratory, CESI Labs. All documentation required by local authorities and customers in order to get the approval are available.

Seismic resistance for civil installations: 0.7 g APN (rms) and 3.5 g peak, without any extra accessories.



Solutions for continuity of service in electrical installations with PrismaSeT



The right level of continuity of service

All organizations have some sensitivity to the continuity of service of electrical power.

For some power is a vital component to their ongoing success and viability.

The required level of continuity of service must be considered for each application so that the electrical installation can be optimised accordingly.

The stakes of continuity of service are high. Even a brief electrical distribution failure can have serious consequences on many activities.

Continuity of service solutions for Operation, Maintenance, Evolution

All solutions proposed comply with standards EN 61439-1 and EN 61439-2.

The system solutions proposed include Schneider Electric products exclusively to fully ensure compatibility and operation.

To ensure safety, solutions with switchgear mounted on plug-in bases, withdrawable chassis and disconnectable or withdrawable mounting plates include safety trip levers that open the circuit breaker if it is removed in closed position.

B



For highest continuity of services

Functional units with devices on live-disconnectable mounting plates

Disconnectable IS 223:
(correspondence with standard IEC 61439-2: WFD)

- High continuity of service
- Maximum time to restore power after maintenance: 1 CEhour
- Live upgrading.

Functional units with devices on live-withdrawable mounting plates

Disconnectable IS 233: (correspondence with standard IEC 61439-2 : WWW)

- High continuity of service
- Maximum time to restore power after maintenance: 1/4 h
- Live upgrading.



See Linergy HK "Hot plug distribution"

- Quick connections
- Panel easily upgradeable
- Reliable "hot plug" modification or upgrade (LVYED213001EN).



Linergy offers you smart power network

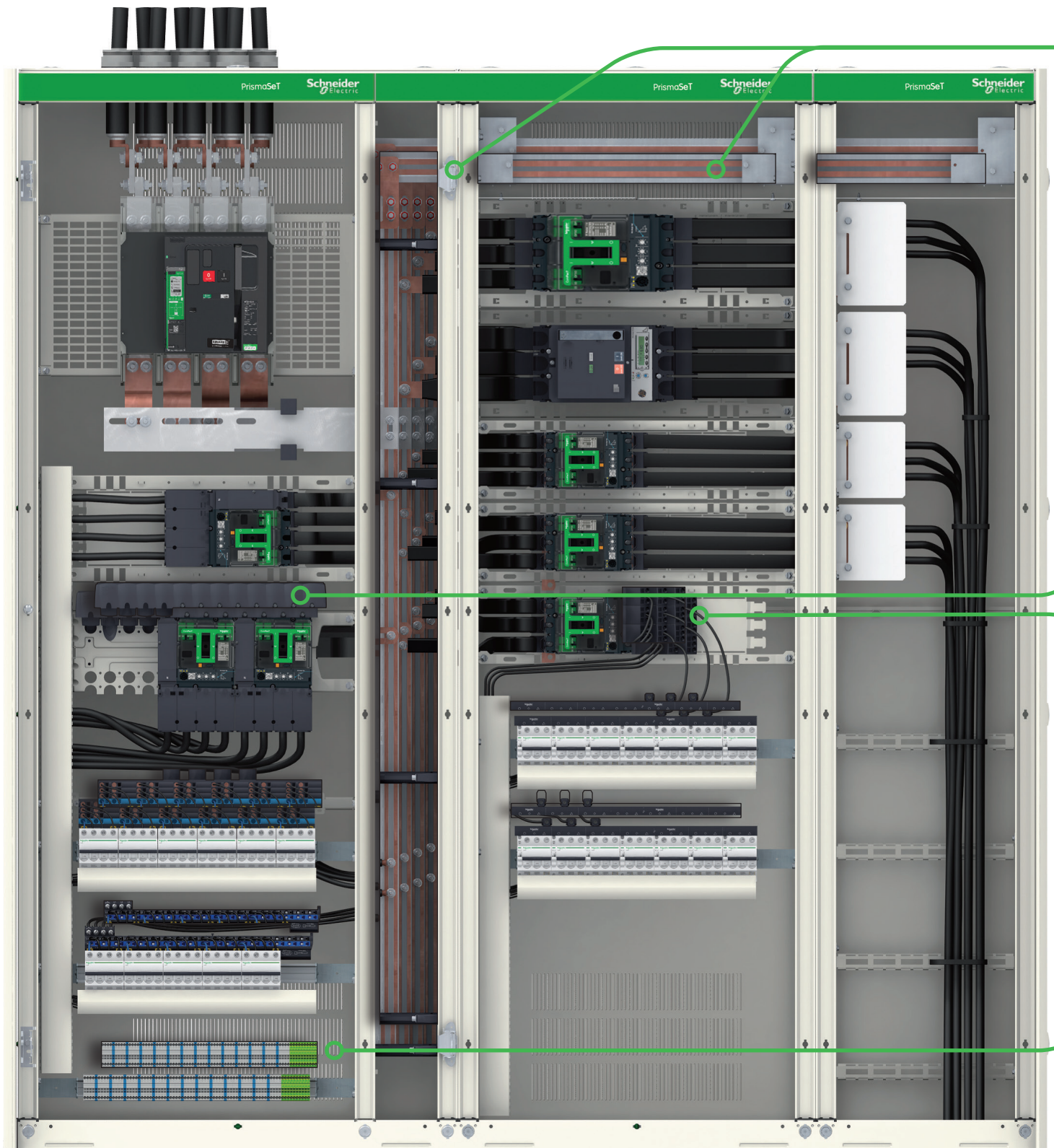

solutions for your switchboard.

B

Linery LGY / LGYE / BS

Power busbars

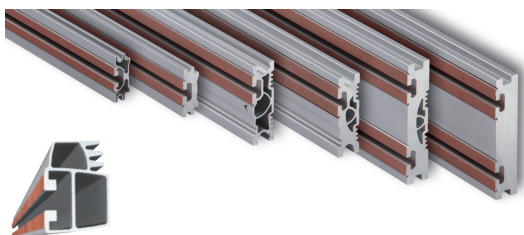

- Solutions available up to 4000 A
- Connection everywhere without drilling (with LGY and LGYE profile)

👉 page G-2 to G-5

Linery FC

Quick distribution blocks

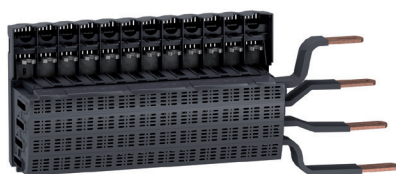

- ComPacT NSXm (4 x 4P / 5 x 3P) solution
- ComPacT NSX (3 x 4P / 4 x 3P) solution
- Reliable connection
- Quick connection system dedicated to ComPacT NSXm up to 160A / ComPacT NSX up to 250 A

👉 pages G-16, G-18

Linery DP

Distribution blocks

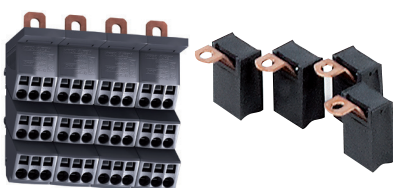

- Simplicity of use
- Quick connection system dedicated to ComPacT NSXm up to 160A / ComPacT NSX up to 250 A

👉 pages G-14, G-15

Linery TR

Terminal blocks and bars

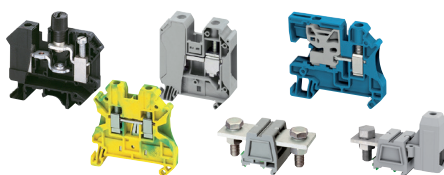

- Simplicity of use
- Consistency and cross-functionality guaranteed

👉 page G-40

Secure power distribution and monitoring solution for operating theatres

To ensure the safety of patients, the availability and quality of electric power are essential. The electrical installations of operating theatres should enable the continuity of healthcare in all circumstances.



A solution you can trust...

- All the components of this solution are designed, manufactured, and tested by Schneider Electric to operate together and be implemented by trained and approved partners.
- Schneider Electric provides maintenance plans and operating procedures linked to this solution.
- Schneider Electric ensure the continuity of the components throughout the installation's life.

... thanks to secure power distribution...

- The solution Schneider Electric incorporates an isolation transformer and a continuous insulation monitor in compliance with the required standards to ensure the supply of power to medical equipment in the event of a first insulation fault.
- The continuity of the electric power supply is ensured thanks to total coordination of all the Schneider Electric components, including and uninterruptible power supply.
- The Schneider Electric solution is designed, wired and tested to attenuate electromagnetic disturbances in accordance with the IEC 60364-4-41 standard.

... to event monitoring and traceability

The Schneider Electric solution incorporates a monitoring system to:

- inform maintenance and medical personnel in real time in the event of an electrical fault in the operating room
- monitor the operating room environment and record all environmental events and data
- provide data to the hospital building management system.



To know more, see the solution guide, ref. DESWED109024.



Enhancing patient safety

Ensuring the satisfactory operation of operating room is essential for a hospital.

Ensuring continuity of electrical service

Because nothing must disturb the medical team during operations.

Improving the efficiency of hospital personnel

A controllable environment and perfectly functioning equipment mean more comfort.

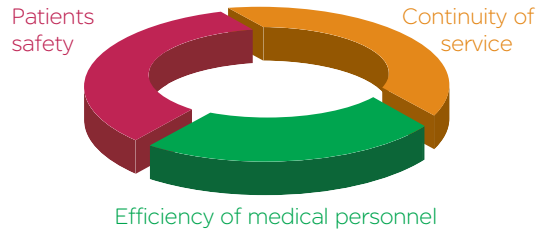



Green Premium™

An industry leading portfolio of offers delivering sustainable value



More than 75% of our product sales offer superior transparency on the material content, regulatory information and environmental impact of our products:

- RoHS compliance
- REACH substance information
- Industry leading # of PEP's*
- Circularity instructions

The Green Premium program stands for our commitment to deliver customer valued sustainable performance. It has been upgraded with recognized environmental claims and extended to cover all offers including Products, Services and Solutions.

CO₂ and P&L impact through... Resource Performance

Green Premium brings improved resource efficiency throughout an asset's lifecycle. This includes efficient use of energy and natural resources, along with the minimization of CO₂ emissions.

Cost of ownership optimization through... Circular Performance

We're helping our customers optimize the total cost of ownership of their assets. To do this, we provide IoT-enabled solutions, as well as upgrade, repair, retrofit, and remanufacture services.

Peace of mind through... Well-being Performance

Green Premium products are RoHS and REACH compliant. We're going beyond regulatory compliance with step-by-step substitution of certain materials and substances from our products.

Improved sales through... Differentiation

Green Premium delivers strong value propositions through third-party labels and services. By collaborating with third-party organizations we can support our customers in meeting their sustainability goals such as green building certifications.



Discover what we mean by green
[Check your products!](#)

*PEP: Product Environmental Profile (i.e. Environmental Product Declaration)

Standards and certifications

Contents

Standards and tested switchboards

Standards

Regional standardization systems	C-2
Standards types	C-3

Enclosure characteristics

Properties of metal enclosures	C-7
---------------------------------------	------------

Thermal characteristics of switchboards

Thermal management of switchboards

General	C-9
Comparative method	C-11
Example	C-12
Charts	C-14
Ventilation	C-15
Heating	C-16

Specific application

PrismaSeT P Active Seismic

Specific application	C-17
Seismic kit	C-18
Installation conditions	C-19

C

Standards

Regional standardization systems



Standards and tested switchboards

IEC international standards

IEC member countries

Argentina	Luxemburg
Australia	Malaysia
Austria	Mexico
Belarus	Netherlands
Belgium	New Zealand
Brazil	Norway
Bulgaria	Pakistan
Canada	Poland
China	Portugal
Croatia	Rumania
Czech Rep.	Russia
Denmark	Singapore
Egypt	Slovakia
Finland	Slovenia
France	South Africa
Germany	Spain
Greece	Sweden
Hungary	Switzerland
India	Thailand
Indonesia	Turkey
Iran	Ukraine
Ireland	United Kingdom
Israel	United States
Italy	
Japan	
Korea (Rep. of)	

The IEC (International Electrotechnical Commission) is a worldwide organisation for standardisation comprising all national electrotechnical committees (IEC National Committees).

The object of the IEC is to promote international cooperation on all questions concerning standardisation in the electrical and electronic fields.

To that end, the IEC publishes International Standards.

Their preparation is entrusted to technical committees and any IEC National Committee interested in the subject dealt with may participate in the preparatory work.

Local standards

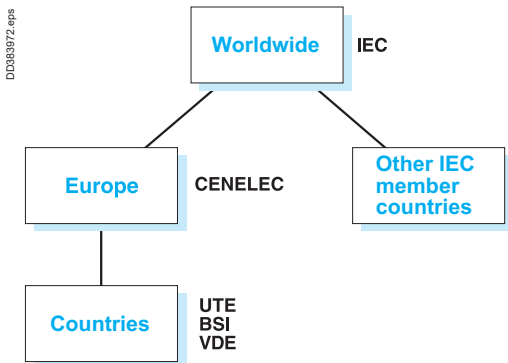

In Europe

The IEC documents are first studied by CENELEC, which establishes:

- either a European standard (EN), often identical to the IEC standard, which then becomes the applicable national standard in all the member countries
- or, in the event of differences, a harmonisation document (HD).

Other IEC member countries

Each country is autonomous and can accept the IEC standard as the national standard, with or without modifications.

Even though they are IEC members, countries such as Japan and the United States continue to develop their own standardisation systems.

Countries without a standardisation system

It is possible to refer to an IEC standard in the framework of a project.

CEI / IEC

Commission Electrotechnique Internationale

CENELEC

Comité Européen de Normalisation ELECTrotechnique

UTE

Union Technique de l'Électricité

VDE

Verband der Elektrotechnik, Elektronik und Informationstechnik

e.v. (German electrotechnical, electronics and computer technology standardisation organisation)

BSI

British Standards Institution

Standards

Standards types



Standards and tested switchboards

The different types of standards

There are different types of standards, including:

- management standards
- installation standards
- product standards.

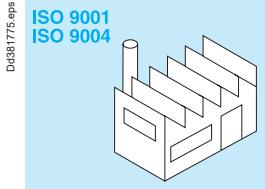

Design and manufacture.

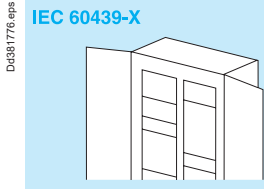

Switchgear and controlgear assemblies.

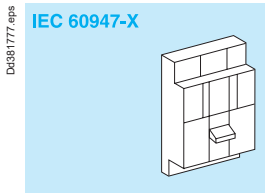

Switchgear and controlgear.

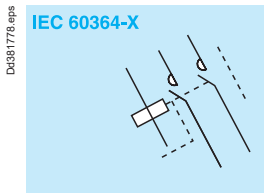

Installation.

Management standards

ISO 9004: Quality-management systems - guidelines for performance improvements. Used in setting up a quality-management system.

ISO 9001: Quality management systems - requirements. Used for certification audits.

ISO 14004: Environmental-management systems. General guidelines on the principles, systems and supporting techniques.

ISO 14001: Environmental-management systems. Specification with guidance for use

- The majority of Schneider Electric development centres and factories are certified ISO 9001 and ISO 14001.

Installation standards

The set of IEC 60364-X standards defines the main principles and rules on:

- determining general characteristics of installations
- protection
- selection and installation of equipment
- verification and maintenance of installations.

Product standards

They apply to devices or assemblies and are aimed at ensuring correct operation and safety of the concerned products.

■ standards on low-voltage switchgear and controlgear:

- IEC 60947-1: general rules
- IEC 60947-2: circuit breakers
- IEC 60947-3: switches and disconnectors
- IEC 60947-4: contactors
- IEC 62208: empty enclosures.

■ standards on low-voltage switchgear and controlgear assemblies:

- IEC 61439-1: general rules
- IEC 61439-2: power switchgear and controlgear assemblies
- IEC 61439-3: distribution boards
- IEC 61439-4: assemblies for construction sites
- IEC 61439-5: assemblies for power distribution
- IEC 61439-6: busbar trunking systems.

Regulations in a given country may make certain standards legally binding and may also create additional safety requirements.

In addition to providing proof of the conformity of its quality-management system, a product manufacturer can demonstrate the quality of products by providing proof that the design and manufacture comply with the requirements in the applicable standard.

Proof of conformity may be a declaration by the manufacturer or a certificate supplied by an independent organisation.



Standards



Standards and tested switchboards

CE marking

CE marking is a regulatory symbol attributed under the sole responsibility of the manufacturer and intended for the verification authorities of the European countries that enforce the European regulations.

It allows free circulation of a product in the European Union and certifies that it complies with the basic requirements in all the applicable European directives. CE marking is not a quality symbol and does not indicate conformity with a standard.

The CE declaration is intended exclusively for the authorities in charge of verifying compliance with the applicable regulations and it is drafted, signed and held for presentation to the authorities by the manufacturer.

For the PrismaSeT P Active range, the declaration is the responsibility of the Schneider Electric

unit that has designed and developed the product.

For LV switchboards, the declaration is the responsibility of the panelbuilder.

The following products receive CE marking:

- all products that are liable to endanger the safety of persons, animals and property (LV directive)
- all products likely to emit electromagnetic disturbances above a standardised threshold or to be disturbed during operation (EMC directive).

Consequences:

- the PrismaSeT P Active range falls under the LV directive only
- LV switchboards are covered by the LV directive and may also fall under the EMC directive, depending on the type of devices incorporated.



For the PrismaSeT P Active range, CE marking is applied:

- on the packing of “mechanical” components
- on the product itself for “electrical” components.

For the LV assemblies created by the panelbuilder, CE marking is applied:

- on the packing
- on the rating plate (if applicable)
- on one of the documents accompanying the switchboard when it is shipped.



Standards and tested switchboards

Degree of protection

Standard IEC 60364-5-51 lists and codifies a large number of external influences to which electrical installations can be subjected, including the presence of water, solid objects, shocks, vibrations, corrosive substances, etc.

IP code

Standard IEC 60529 (IP code, February 2001) indicates the degrees of protection provided by an enclosure for electrical devices against access to hazardous parts, against penetration of solid foreign objects and against penetration of water.

These standards do not apply for the protection against the risks of explosion or conditions such a humidity, corrosive vapour, fungus or vermin.

The IP code is made up of two characteristic numerals and can include an additional letter when the actual protection for persons against access to the hazardous parts is better than that indicated by the first numeral.

The first numeral characterises the protection provided against the ingress of solid foreign objects and the protection of persons.

The second numeral characterises the protection provided against the ingress of water with harmful effects.

1 st numeral		2 nd numeral		
Protection of persons		Protection against ingress of solid objects		
1	Protected against access with back of hand Ø50 mm	Protection against solid foreign objects larger than 50 mm Ø50 mm	1	Protected against vertically dripping water (condensation)
2	Protected against access with a finger Ø12 mm	Protection against solid foreign objects larger than 12.5 mm Ø12,5 mm	2	Protected against dripping water up to 15° from vertical 15°
3	Protected against access with a tool Ø2,5 mm	Protection against solid foreign objects larger than 2.5 mm Ø2,5 mm	3	Protected against spraying water up to 60° from vertical 60°
4	Protected against access with a wire Ø1 mm	Protection against solid foreign objects larger than 1 mm Ø1 mm	4	Protected against splashing water from all directions
5	Protected against access with a wire Ø1 mm	Protected against dust (dust protected) 	5	Protected against water jets from all directions
6	Protected against access with a wire Ø1 mm	Dust tight 	6	Protected against powerful water jets from all directions
			7	Protected against the effects of temporary immersion in water
			8	Protected against the effects of continuous immersion in water
			9	Protected against close-range high pressure, high temperature spray downs



Standards and tested switchboards

Degree of protection

IP Code

Standard IEC 60364-5-51 lists and codifies a large number of external influences to which electrical installations can be subjected, including the presence of water, solid objects, shocks, vibrations, corrosive substances, etc.

The additional letter is used only if the actual protection of persons is higher than that indicated by the first characteristic numeral of the IP code.

Additional letter	Protection
A	Protected against access with back of hand
B	Protected against access with a 12 mm diameter finger
C	Protected against access with a 2.5 mm diameter tool
D	Protected against access with a 1 mm diameter wire

If only the protection of persons is of interest, the two characteristic numerals are replaced by the letter "X", e.g. IPXXB.

Illustration of the above explanations:

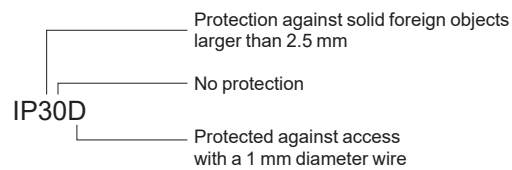

Remarks

■ The degree of protection IP must always be read and understood numeral by numeral and not as a whole.

For example, an IP31 wall-mount enclosure is suitable for an environment that requires a minimum degree of protection IP21. However an IP30 wall-mount enclosure is not suitable.

■ the degrees of protection indicated in this catalog are valid for the enclosures as presented. However, the indicated degree of protection is guaranteed only when installation and device mounting are carried out in accordance with professional standards that conserve the initial degree of protection.

IK code

Standard IEC 62262 defines an IK code characterising the capacity of products to resist mechanical impacts from all sides.

IK code	Impact energy (joules)
01	0.14
02	0.2
03	0.35
04	0.5
05	0.7
06	1
07	2
08	5
09	10
10	20

IK codes can be selected according to the risks of impacts on a given site.

	Site	Recommended IK
No risk of major impact	Technical premises	07
Significant risk of impact that can damage devices	Hallways	08 (switchboard with door)
Maximum risk of impact that can damage the switchboard	Workshops	10

Properties of metal enclosures

Enclosure characteristics

Anti-corrosion withstand

Schneider Electric enclosures comply with standard IEC 62208, EN 50298 for empty enclosures. The sheet metal used for Schneider Electric enclosures receives an anti-corrosion cathaphoresis primer treatment and a coating of a thermosetting, polyester-resinmodified epoxy powder for colour and appearance.

This two-coat system provides excellent finish and corrosion protection.

The characteristics of this coating are much better than those of traditional epoxy powders:

- improved colour stability
- wider operating temperature range.

Mechanical properties of frame

Static load on doors, wall-mounted and floor-standing enclosures and cubicles

Cubicle	400 kg
Cubicle door	12 kg

Mechanical properties of powder coated surfaces

Test conditions

Test piece made of 1 mm thick steel sheet, degreased, iron phosphated, final rinsing with 100 kΩ cm DI water, 15 microns of anti-corrosion electrophoresis treatment and 35 microns of powder paint.

Adhesion (cross-hatch and pull-off)	class 0 required	(ISO 2409)
Impact strength(1)	> 1 kg/50 cm	(ISO 6272)
Mandrel bending test (2)	< 10 mm	(ISO 6860)
Persoz hardness	300 s	(ISO 1522)

(1) No cracking of the paint film after dropping a weight of 1 kg on the test piece from a height of 50 cm.

(2) Film cracks over a length of 10 mm maximum.

Artificial ageing test on powder coating

Test conditions:

Two tests carried out on the same 1 mm thick steel sheet test piece.

- cyclical damp-heat test:
 - as per standard IEC 68-2-30
 - six 24-hour cycles at temperatures higher than 40 °C
- continuous resistance to neutral salt mist:
 - the tests were carried out over a period of 400 hours, far more than the 48 hours required by the standard for indoor installations
 - as per standard IEC 68-2-11 and ISO 7253
 - 400 hours without blistering for normal surface on test piece
 - 250 hours for a scratched surface.

Evaluation of corrosion as per ISO 4628:

- adhesion: class ≤ 1
 - blistering: degree 1 dim. 1
 - rusting: Ri 1
 - cracking: class 1
 - flaking imp. 1 dim. 1
- propagation of corrosion under scratch with respect to the scratch axis: 3 mm max.

Properties of metal enclosures

Enclosure characteristics

Chemical properties of powder coating

Tests carried out at ambient temperature on phosphated test pieces coated with a 150 to 200 micron film.

Test duration (months)		2	4	6	8	10	12
Acids	Concentration						
	Acetic 20 %						
	Sulphuric 30 %						
	Nitric 30 %						
	Phosphoric 30 %						
	Hydrochloric 30 %						
	Lactic 10 %						
Bases	Citric 10 %						
	Soda 10 %						
Ammonia 10 %							
Water	Distilled water						
	Seawater						
	Tap water						
	Diluted bleach						
Solvents	Petrol						
	High alcohols						
	Aliphatics						
	Aromatics						
	Ketones, esters						
	Tri-perchloroethylene						

 Film intact.

 Film damaged (blisters, yellowing, loss of shine).

Thermal management of switchboards

General

Thermal characteristics of switchboards

A switchboard is designed for operation under normal ambient conditions. Most devices do not operation correctly outside a temperature range of -10 and +70 °C.

It is therefore important to maintain the switchboard internal temperature within this temperature range by:

- correctly sizing the switchboard during design
- correcting the temperature using suitable means.

Management of the internal temperature

Cooling

There are a number of way to dissipate heat from the switchboard. The drawings below present the various means.

Convection

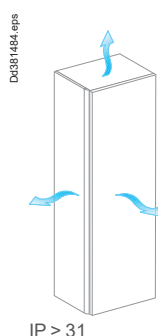

Ensured naturally in PrismaSeT P Active enclosures.

Forced-air ventilation

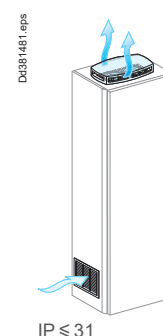
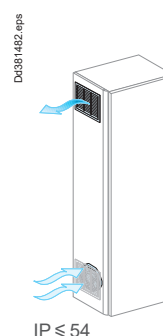
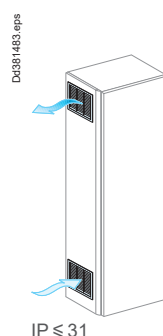

Using fans, it significantly increases the thermal capacity of an enclosure.

Forced-air ventilation with air-air exchanger

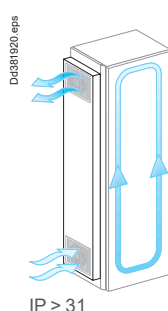

On special request.

Forced convection and cooling

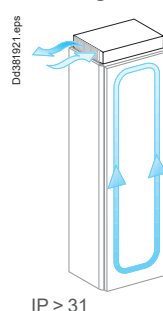

For these extreme cases, many installers prefer to set up the switchboards with other electrotechnical and electronic devices in air-conditioned electrical rooms.

Heating

The means employed to raise the internal temperature in a switchboard is a resistor-based heater, used to:

- avoid condensation by limiting variations in temperature
- ensure that the switchboard does not freeze.

Thermal management of switchboards

General

Thermal characteristics of switchboards

Calculation of the internal temperature

Calculation of the temperature is the means to check that the enclosure can evacuate the dissipated power of the installed devices.

Important note

Correct thermal management of the switchboard depends on compliance with the installation requirements for the distribution system (power circuits).

Incorrect installation will have major consequences on the connected device, but almost none on the internal temperature of the enclosure.

Once the circuit has been correctly sized, it is necessary to check whether the assembly (devices + distribution system + cables) have a level of dissipated power $P(W) \leq$ the $P(W)$ that the enclosure can handle.

Method defined by IEC 890 technical report

This IEC guide for switchboards proposes a calculation method to determine three levels of internal temperature, depending on the dissipated power of the devices and distribution blocks installed in the switchboard.

Users can consult this document when it is necessary to determine precisely the internal temperature in view of optimising the switchboard.

On request, Schneider Electric can carry out a thermal study to check that the installed assembly and the thermal capacity of the enclosure are compatible.

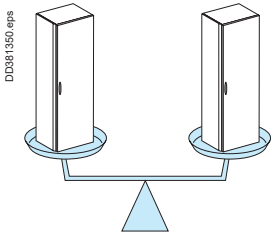
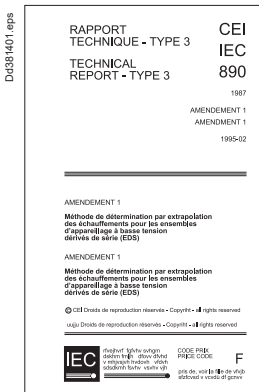

Comparative method

A number of qualified and tested configurations serve as the basis for indicating the thermal capacity of PrismaSeT P Active enclosures.

This is an empirical means to check whether the dissipated power of the desired configuration is close to that of a tested configuration.

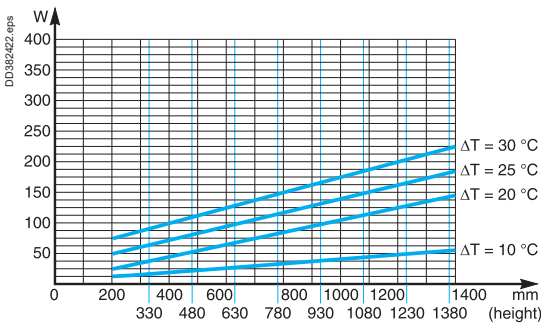

Method using charts taking into account enclosure characteristics

To speed up calculations, Schneider Electric produces charts based on the company's experience and a number of assumptions on the installation.

They can be used sufficiently precisely to determine the variations in temperature and the dissipated-power levels for the different types of wall-mounted enclosures, floor-standing enclosures and cubicles.

For details on the calculation of the dissipated power in the device zone, see page C-12.

Thermal management of switchboards

Comparative method

Thermal characteristics of switchboards

Two cubicles with busbar compartment, 800 mm wide, 400 mm deep, IP30

Diversity factor: 0.7 and 0.8

Ambient temperature around the switchboard: 35 °C

Cubicle **1**: P(W) of device zone = 580 W

Cubicle **2**: P(W) of device zone = 180 W

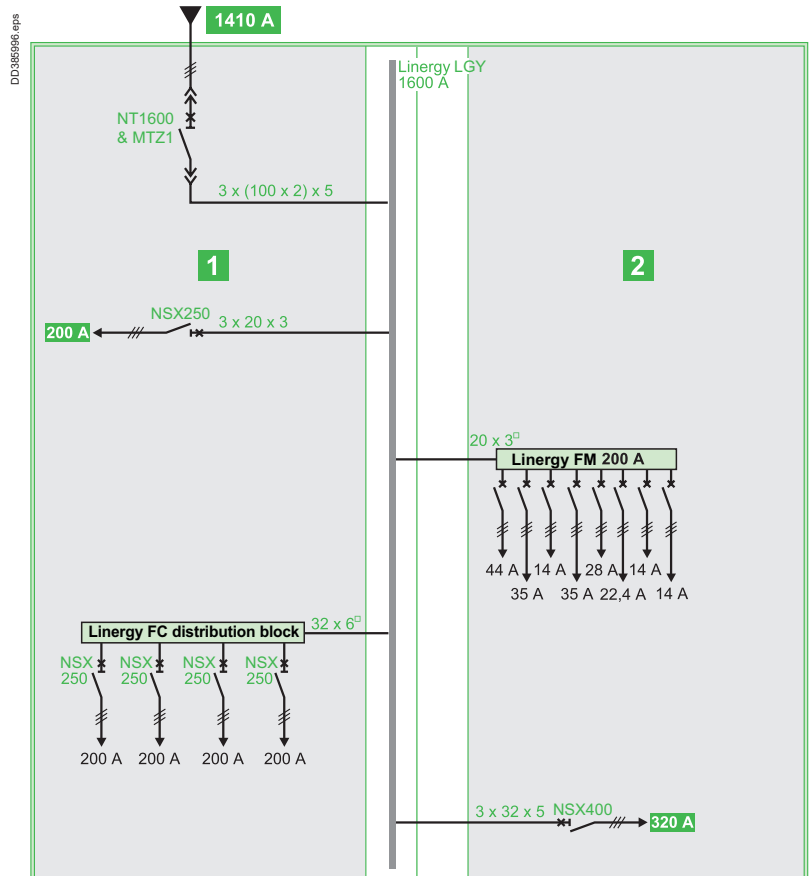

Two cubicles with busbar compartment, 800 mm wide, 1000 mm deep, two 300 mm wide ducts, IP30

Diversity factor: 0.7

Ambient temperature around the switchboard: 35 °C

Cubicle **1**: P(W) of device zone = 880 W

Cubicle **2**: P(W) of device zone = 330 W

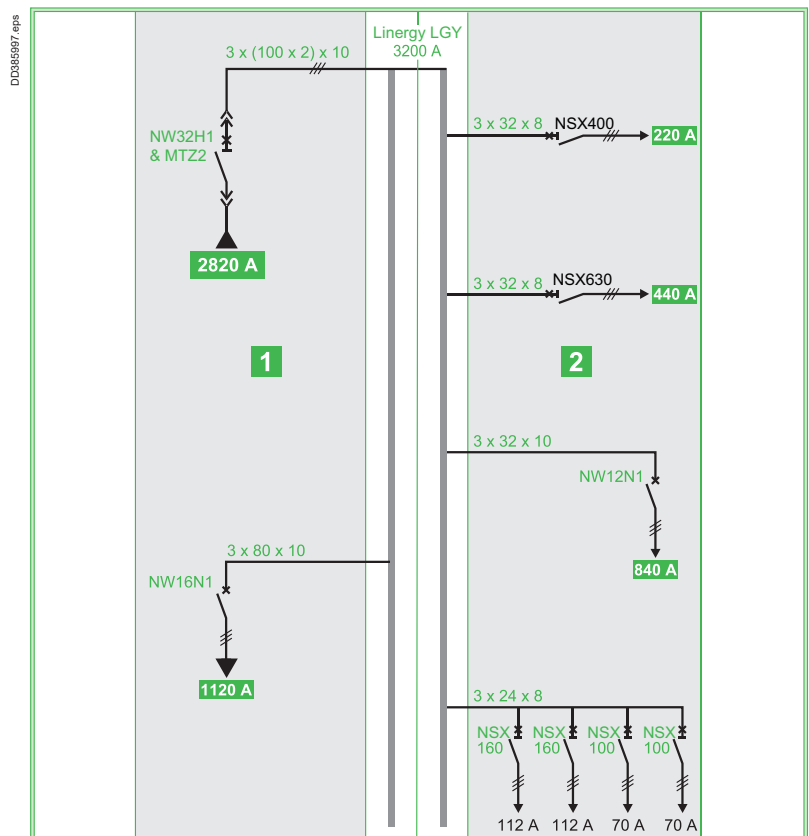

Thermal management of switchboards

Example

Thermal characteristics of switchboards

Two cubicles with busbar compartment, 800 mm wide, 1000 mm deep, two 300 mm wide ducts, IP30

Diversity factor: 0.7

Ambient temperature around the switchboard: 35 °C

Cubicle 1: P(W) of device zone = 580 W

Cubicle 2: P(W) of device zone = 180 W

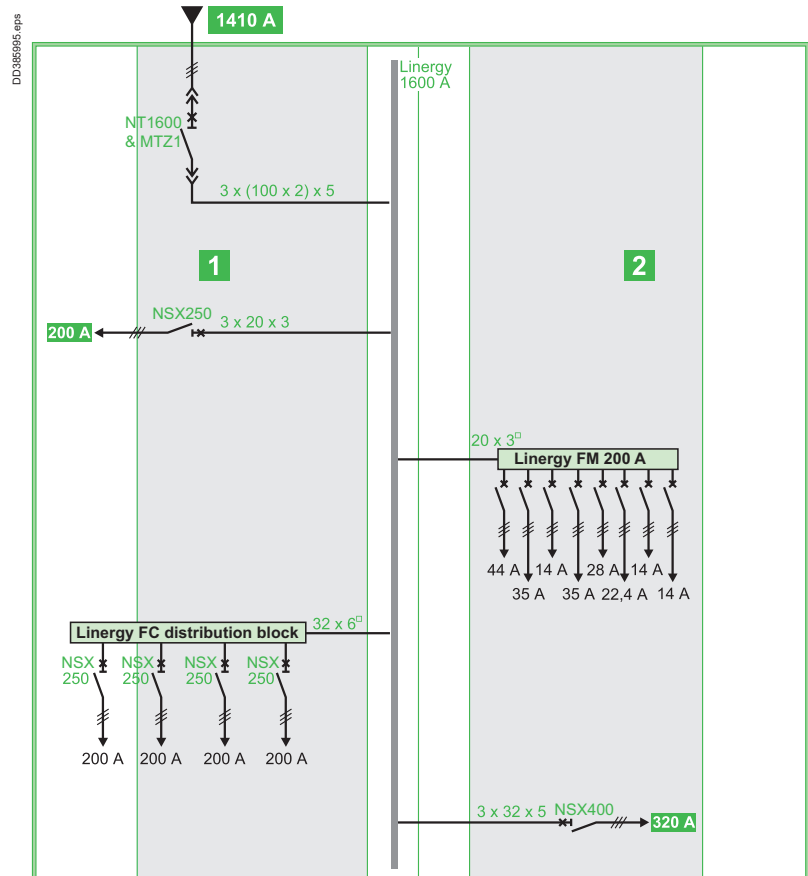

Application of the diversity factor

In the configuration below, the standardised diversity factor (K div.) for a total of 14 outgoing circuits is 0.6, i.e. 60 % of In for each outgoing circuit. Schneider Electric prefers a more conservative approach and therefore divides the installation into four main circuits:

- ComPacT NSX250
- 200 A Linery FM: 8 outgoers → K div. = 0.7
- Linery FC: 4 outgoers → K div. = 0.8
- ComPacT NSX400.

1 ComPacT NSX250 + 1 Linery FM 200 A + 1 Linery FC + 1 ComPacT NSX400 → 4 outgoers, i.e. a diversity factor of 0.8.

As a result, the current flowing in each circuit is at least 70 % and up to 80 % of In.

Calculation of the power dissipated by devices in the incoming cubicle

Dissipated power of the NT1600 & MTZ1 indicated by the manufacturer: 460 W. The power dissipated by the connections is approximately 30 % of the device P(W):
 $0.3 \times 460 = 138 \text{ W}$.

Power of circuit breaker + connections = 460 + 138 = 598 W at 1600 A.

For I² (the Watts are proportional to the square of the current) at 1410 A (In of the incoming device):

Dissipated power of the ComPacT NSX250 indicated by the manufacturer: 42 W.

Dissipated power of the connections: $0.3 \times 42 = 12.6 \text{ W}$.

Power of circuit breaker + connections = 42 + 12.6 = 54.6 W at 250 A.

For 200 A (the tested value):

$$\frac{54.6}{250^2} \times 200^2 = 35 \text{ W}$$

Dissipated power of the Linery FC and its four ComPacT NSX250 circuit breakers:

$$4 \times 35 \text{ W (same calculation as above)} = 140 \text{ W}$$

Sum of the dissipated power in the incoming cubicle:

$$P(W) = 405 + 35 + 140 = 580 \text{ W}$$

Thermal management of switchboards

Example

Thermal characteristics of switchboards

Once the dissipated power of the devices has been determined and the enclosure with its IP selected, transfer the results (sum of the dissipated power and width of the device zone) to the chart corresponding to the enclosure IP.

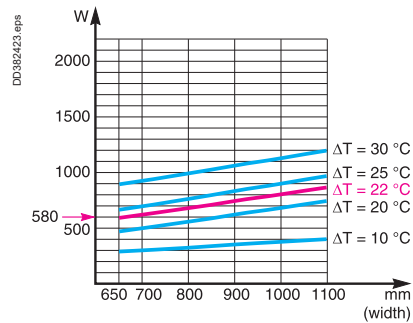

Draw a line parallel to the others on the chart and read the corresponding difference in temperature.

For the given example, the heat rise is 22 °C at mid-height in the enclosure.

The internal temperature = external temperature + heat rise
 $= 35\text{ °C} + 22\text{ °C} = 57\text{ °C}$

57 °C < 60 °C stipulated by the standard, i.e. the result is acceptable for an IP3 cubicle.

This gives roughly: Internal temperature = 60 °C at mid-height in the enclosure for a low IP value.

Internal temperature = 70 °C at mid-height in the enclosure for a high IP value.

Thermal management of switchboards

Charts

Thermal characteristics of switchboards

Test conditions: the cubicle is on the floor against a wall, the indicated internal heat rise is that measured at mid-height in the enclosure.

For the enclosures not mentioned on the previous pages, use the equation:

$$\Delta T = \frac{P}{S \times K}$$

- ΔT:** internal temperature - external temperature
- P:** power dissipated by the devices, connections and busbars (in Watts)
- S:** total free surface area of the enclosure (expressed in m²)
- K:** thermal-conduction coefficient of the material (W/m² °C)

K = 5.5 W/m² °C for painted sheet metal.

Note: the dissipated power of each device is provided by the manufacturer. Add approximately 30 % to account for the connections and the busbars.

IP3X cubicle, 400 mm deep

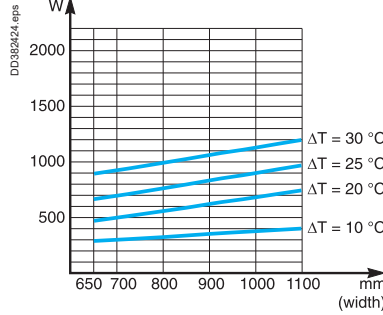

IP3X cubicle, 600 mm deep

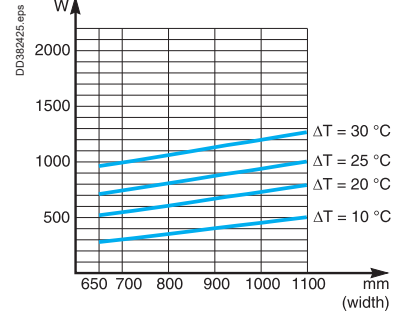

IP3X cubicle, 800 mm deep

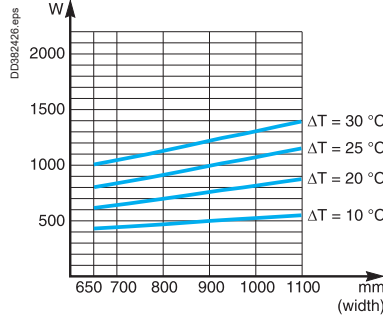

IP3X cubicle, 1000 mm deep

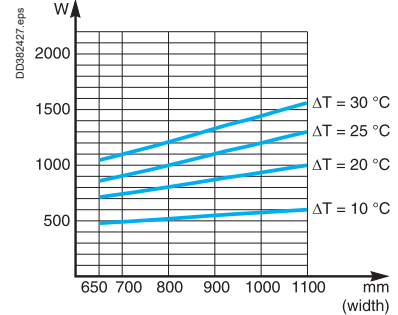

IP55 cubicle, 400 mm deep

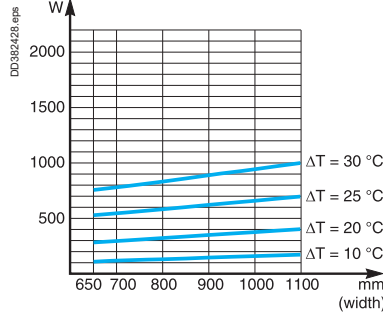

IP55 cubicle, 600 mm deep

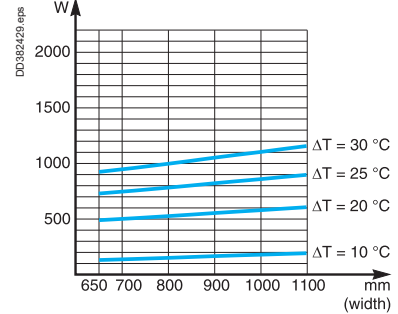

IP55 cubicle, 800 mm deep

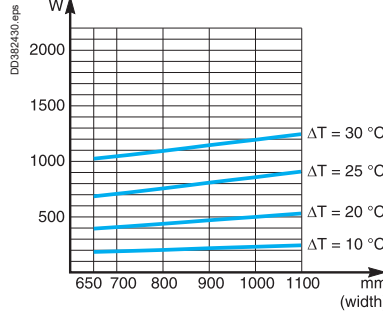

IP55 cubicle, 1000 mm deep

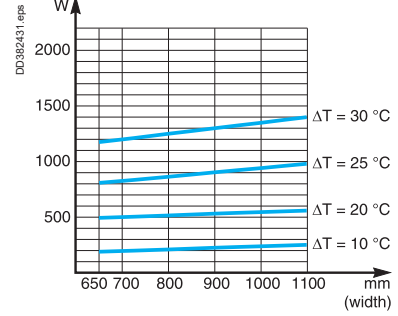

Thermal management of switchboards

Ventilation

Thermal characteristics of switchboards

The air enters the lower section via the fans and exits the upper section:

- through a ventilated roof
- or through a ventilation opening.

The air throughput of the fans is determined by the equation:

$$D = 3.1 \times \left(\frac{P}{\Delta T} - KS \right)$$

The chart below can be used to determine the necessary throughput, based on the dissipated power, the difference in temperature (internal - external) and the exposed surface area of the enclosure.

Example

Consider an IP3X cubicle, 650 mm wide and 400 mm deep, containing components (devices, connections, busbars, etc.) dissipating 1000 W.

The ambient temperature around the cubicle is 50 °C.

Given that the average temperature at mid-height should not exceed 60 °C, the difference in temperature ΔT is equal to 60 - 50 = 10 °C.

The exposed surface of the cubicle (non adjacent to a wall or other cubicle) is 4.46 m².

(back = 1.3 m², front = 1.3 m², roof = 0.26 m², side panels = 1.6 m²).

What is the necessary throughput of the ventilation system?

The throughput can be calculated as:

$$D = 3.1 \times \left(\frac{1000}{10} - 5.5 \times 4.46 \right)$$

$D = 234 \text{ m}^3/\text{h}$.

In the range of PrismaSeT P Active accessories, select a system with a throughput of 300 m³/h.

Ref: **LVS08710**

In the duct 150mm & 300mm = no need cross members

In the duct 400mm without devices = no need cross members

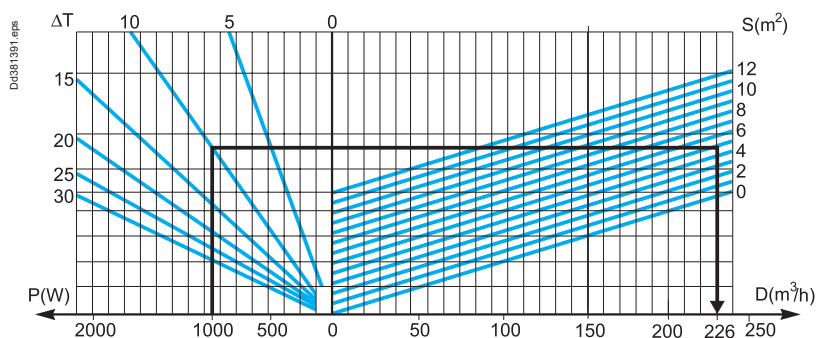
**Calculation data**

P: power dissipated by the devices, connections and busbars (in Watts)

Pr: power of the heating resistor (in Watts)

Tm: maximum internal temperature in the device zone (in °C)

Ti: average internal temperature (in °C)

Te: average external temperature (in °C)

$\Delta T_m = T_m - T_e$

$\Delta T = T_i - T_e$

S: total free surface area of the enclosure (expressed in m²)

K: thermal-conduction coefficient of the material (W/m² °C)

$K = 5.5 \text{ W/m}^2 \text{ °C}$ for painted sheet metal

D: ventilation throughput (in m³/h)

Note: The dissipated power of each device is provided by the manufacturer. Add approximately 30 % to account for the connections and the busbars.

Thermal management of switchboards

Heating

Thermal characteristics of switchboards

The heating resistor, placed in the bottom of the switchboard, maintains the internal temperature 10 °C higher than the external temperature. When the switchboard is not in operation, the heater compensates the dissipated power normally emitted by the switchboard.

The power of the heating resistor is calculated:

■ using the equation: $P_r = (\Delta T \times S \times K) - P$

■ or using the charts below, based on the exposed surface area of the enclosure and the desired difference in temperature.

Chart to determine the heating resistor for small wall-mounted enclosures (exposed surfaces ≤ 1 m²)

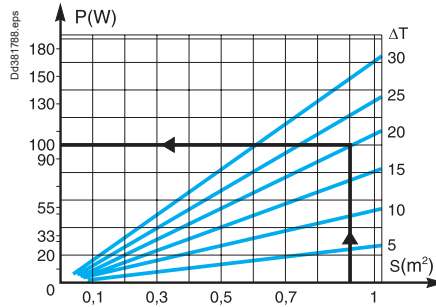
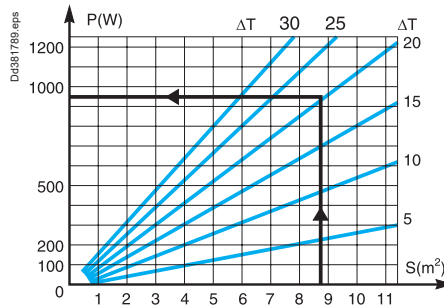

Chart to determine the heating resistor for all types of enclosures and cubicles



Calculation data

P: power dissipated by the devices, connections and busbars (in Watts)

P_r: power of the heating resistor (in Watts)

T_m: maximum internal temperature in the device zone (in °C)

T_i: average internal temperature (in °C)

T_e: average external temperature (in °C)

$$\Delta T_m = T_m - T_e$$

$$\Delta T = T_i - T_e$$

S: total free surface area of the enclosure (expressed in m²)

K: thermal-conduction coefficient of the material (W/m² °C)

K = 5.5 W/m² °C for painted sheet metal

D: ventilation throughput (in m³/h).

Note: The dissipated power of each device is provided by the manufacturer. Add approximately 30 % to account for the connections and the busbars.

PrismaSeT P Active Seismic

Specific application

Specific application

Seismic zone

Around the world can be found different zones with a specific seismic risk. These zones have been classified according to the Uniform Building Code (UBC).

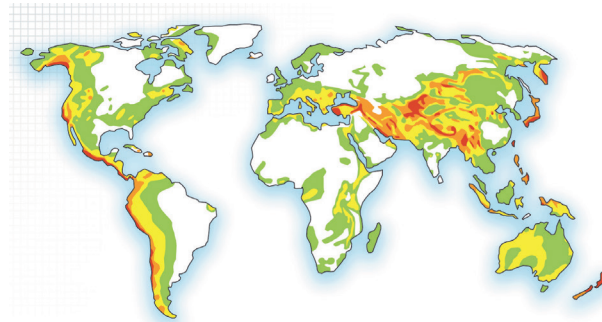

Switchboard qualification

Tests are carried out on switchboards to ensure that they operate correctly (structural and functional integrity) under severe earthquake conditions and meet specific safety requirements. The tests carried out to qualify these switchboards are described in the international standard IEC 60068-3-3.

Classification

From weak to strong earthquakes, PrismaSeT P Active has been tested in the following ground accelerations to guarantee the right performance on seismic risk.

IEC 60068 -3-3 Ground acceleration	Seismic characteristics			
References	General description	Richter scale magnitude	MSK Intensity	UBC Zone
AG2	Intensity from weak to average	< 5.5	< VIII	0 1
AG3	Intensity from average to strong	5.5 to 7.0	VIII to IX	2 3
AG5	Intensity from strong to very strong	> 7.0	> IX	4

PrismaSeT P Active is compliant up to level AG5 from IEC 60068-3-3 (2.5 g) :

Compare PrismaSeT switchboard performances with seismic standards
Damping 5% - horizontal

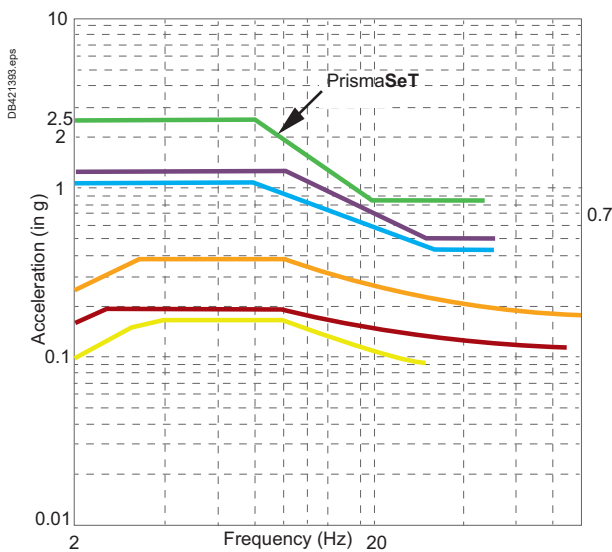

Compare PrismaSeT switchboards performances with seismic standards
Damping 5% - vertical

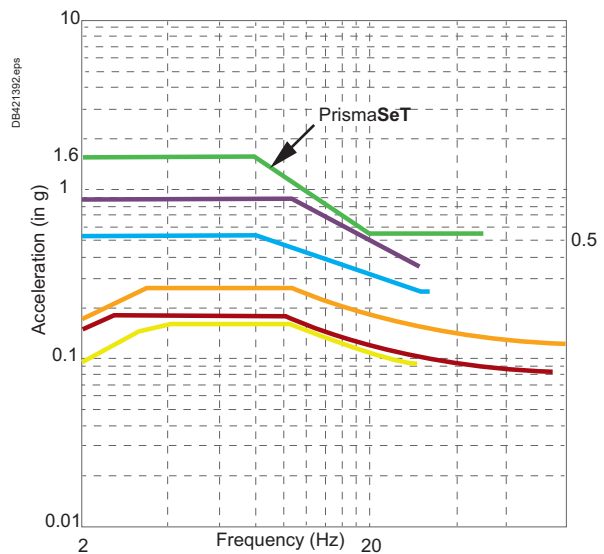

Country	Standard	Parameters
PrismaSeT P Active	IEC60068-3-3	Up to level AG5
Russia	GOST 17516.1-90	Civil Market (Seismic intensity 8, all installation levels) or (Up to Seismic Intensity 9, Level 1 only)
Chile	ENDESA 1986	All seismic categories
Turkey	Seismic Turkish Code 2009	All seismic zones, all site class
Greece	EAK 2000	All soil types, Worst case
Australia	AS1170	All soil types, Worst case
UBC	1997-AC156	Zone 4 - Ground Level

PrismaSeT P Active Seismic

Seismic kit

Specific application

Reinforcement

PrismaSeT P Active seismic cubicles are 2.5 g compliant.

Special parts have been created, specific reinforced side panels and bottom reinforcement brackets.

Reinforced side panels

Ref: LVS08765D

To respect seismic withstand, use side panels in IP55 version (even with an IP30 switchboard).

**Seismic reinforcement brackets**

Ref: LVS08710

Foot part to be added in each bottom angle to reinforce the structure.

**Seismic Kit with cross-members**

With ducts 150 mm & 300 mm = cross-members not needed

With duct 400 mm without devices = cross-members not needed

For the cubicles

Ref: LVS03587 x2 or LVS08774 x1

- >1 cross-member at the top, on the rear upright
- >1 cross-member in the middle, on the rear upright
- >2 cross-members at the bottom, on the rear uprights.

Note : Cross-members must be added in a rear compartment in case of depth 1000 mm.

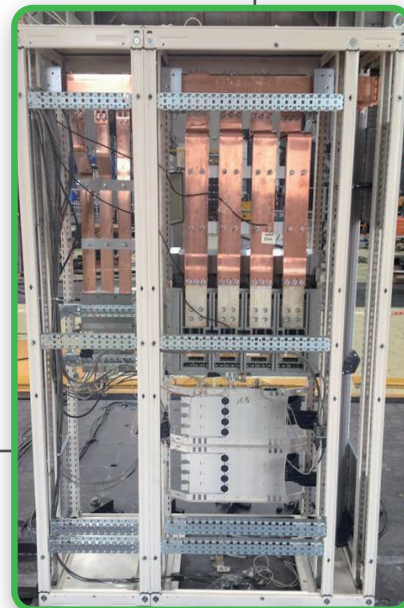

PrismaSeT P Active Seismic

Installation conditions

Specific application

PrismaSeT P Active cubicle frames

PrismaSeT P Active cubicle frames have to be assembled according to the mounting instructions (04696505) and must respect the tightening torque and association screws position.

Functional units have to be assembled according to the mounting instructions supplied with each reference.

Fixing points to ground

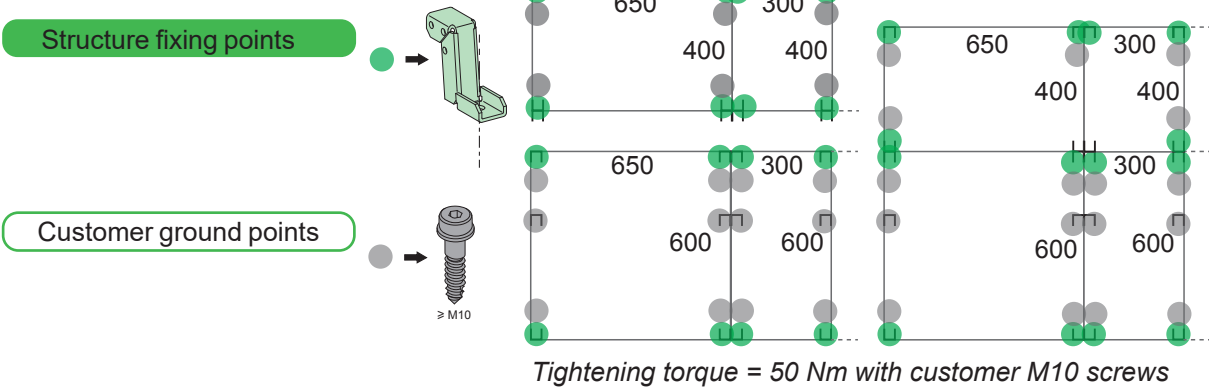

Nota : cubicle of the same switchboard must have the same depth
Refer to QGH13690 leaflet for compliant assembly

Sizes to respect

Dimensional specifications have to be taken into account for the switchboard sizes and busbar ratings.

Switchboard sizes:

- > Minimum switchboard width (1) = 1200 mm
- > Minimum cubicle depth = 400 mm
- > Height = 2000 mm

Nota: Seismic switchboards must not be installed with any plinth.
(1) Switchboard must be equipped with horizontal busbars

Maximum busbar ratings:

	3P	4P
Horizontal Linergy BS	2b 80 x 10	2b 80 x 10
Horizontal Linergy LGYE	LGYE 4000	LGYE 4000

Devices installation limit

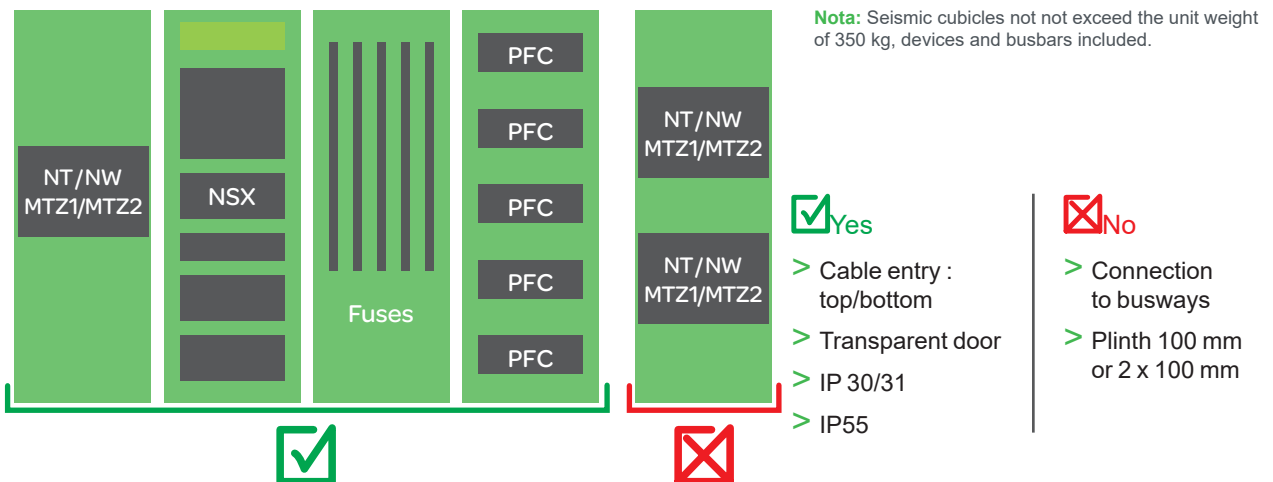

NOTICE

HAZARD OF STRUCTURAL FAILURE

Seismic cubicles must have the same depth. Plinths are not allowed in seismic configurations

Failure to follow these instructions can result in equipment damage

Selection guide

Selection guide

Select a cubicle configuration

D-2

D

Select a cubicle configuration

Starting with the electrical diagram:
IP30 switchboard

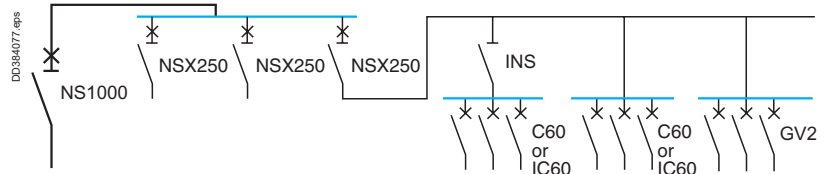

E Prisma P Functional units

Install the incomer

See page E-2

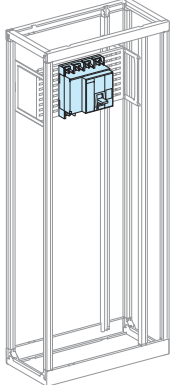

- Order
- connection components
 - mounting plates and front plates
 - busbar connections.

1 Front conn. using cables

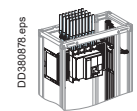

2 Device installation

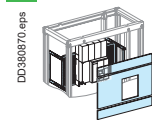

3 Linergy LGY BB conn.

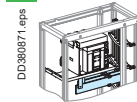

Device	Fixed device
Arc chute screen	NS630b/1000 NS1250/1600
3P	33596
4P	33597
Vertical connection adapters	3P 33642
4P	33643
Front connection cover	04851

Mounting Device	Front connection with cables
Fixed device	NS630b/1000 NS1250/1600
Number of devices per row	1 1
No. of vertical modules	12 14
Mounting plates	03482 03482
Front plates	upstream 03802 [2] 03804 [4]
[No. of vertical modules]	with cut-out 03690 or 03701 [7]
	downstream 03803 [3] 03803 [3]

Device	Fixed device
Connection type	NS630b/1250 NS1600
Busbars connection	Front connection delivered with the device
	For Linergy LGY busbars: prefabricated connection
3P	04485 04487
4P	04486 04488
Cover for busbars connection	04926
Linergy LGY, LGYE, BS	

E Prisma P Functional units

Install the Compact devices

See page E-20

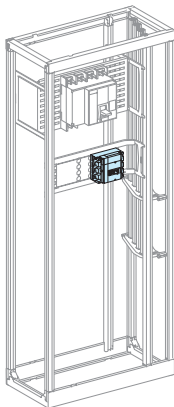

- Order
- mounting plates and front plates
 - busbar connections
 - connection accessories.

1 Installation

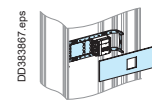

2 Linergy LGY BB conn.

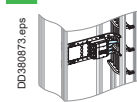

3 Connection

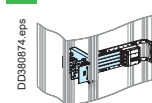

Device	Toggle
	NSX100/250, Vigi NSX100/250
Number of device per row	3P 1 4P 1
No. of vertical modules	3 4
Mounting plates	03411 03412
Front plates	with cut-out 03604 [3] 03606 [4]
[No. of vertical modules]	

Device	Linergy LGY Toggle
	NSX100/250, Vigi NSX100/250
Prefabricated connection	3P 04423 4P 04424

Device	Toggle
	NSX100/160 Vigi NSX100/160 NSX250 Vigi NSX250
Number of device per row	3/4 3/4 3/4 3/4
No. of vertical modules	6 8 7 9
Mounting plates	03420 03420 03420 03420
Front plates	with cut-out 03243 [5] 03241 [7] 03243 [5] 03241 [7]
[No. of vertical modules]	downstream 03801 [1] 03801 [1] 03802 [2] 03802 [2]

E Prisma P Functional units

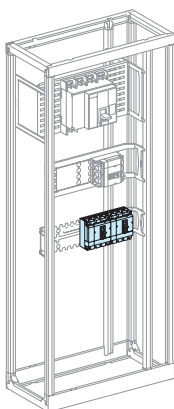

- Order
- mounting plates and front plates
 - distribution block
 - connection accessories.

1 Installation

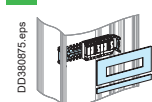

2 Linergy LGY BB conn.



3 Connection



Device	Toggle
	NSX100/160 Vigi NSX100/160 NSX250 Vigi NSX250
Number of device per row	3/4 3/4 3/4 3/4
No. of vertical modules	6 8 7 9
Mounting plates	03420 03420 03420 03420
Front plates	with cut-out 03243 [5] 03241 [7] 03243 [5] 03241 [7]
[No. of vertical modules]	downstream 03801 [1] 03801 [1] 03802 [2] 03802 [2]

Device	Linergy LGY Toggle
	NSX100/160, Vigi NSX100/160 NSX250, Vigi NSX250
Number of devices	3P 4 4P 3
Linergy FC distribution blocks (with connection)	04403 04404 04403 04404

Device	Toggle
	NSX100/160, Vigi NSX100/160 NSX250, Vigi NSX250
Front connection long terminal shields	3P LV429517 4P LV429518 3P LV429517 4P LV429518
Rear connection short terminal shields	LV429515 LV429516 LV429515 LV429516

Install the modular devices

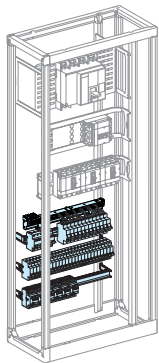

DD385315.eps

Order the mounting plates and front plates taking into account:

- supply to the rows
- cable running.

1 Acti 9

See page E-63

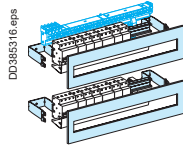

DD385316.eps

2 GV2 circuit breaker

See page E-62

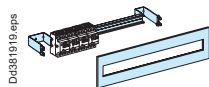

DD381918.eps

Device	All modular devices	Modular devices ≤ 40 A
Rail length (modules of 9 mm)	48	48
No. of vertical modules	4	3
Rail (48 modules of 9 mm)	03401	03401
Modular front plates	03204 [4]	03203 [3]
Blanking plate strip	03220	03220
divisible	03221	03221

Device	Circuit breaker	GV3
No. of vertical modules	GV2RT - GV2ME - GV2LE	5
Useful length of rail (mm)	432	
Modular rail (adjustable)	03401	03402
Front plates with cut-out	03203 [3]	03205 [5]
[No. of vert mod]		

Linery FH comb busbar see page F-30 to F-34
Cable running see page F-27

Determine the size of the switchboard

- count the number of modules occupied
- determine the number of cubicles
- order the additional plain front plate.

32 modules

1 cubicle

Plain front plate
See page F-22

The capacity of a cubicle is 36 modules.

Device	Plain front plate W = 500 mm					
	H = 50 mm	H = 100 mm	H = 150 mm	H = 200 mm	H = 250 mm	H = 300 mm
[No. of vert mod]	[1]	[2]	[3]	[4]	[5]	[6]
Cat. no	03801	03802	03803	03804	03805	03806

Select the enclosures

See page F-1

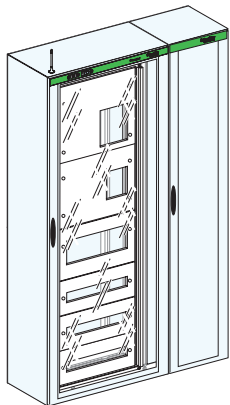

DD380827.eps

1 Frameworks

2 Hinged front plate support frame

3 Doors

4 Rear panels

5 Side panels

6 Roofs

7 Plinth, gland plates, finishing parts, etc.

Device	300	400	650	800	800 (650 + 150)
Base frame					
Cat. no	08403	08404	08406	08408	08407

Device	400	650
Hinged front plate support frame		
Cat. no	08564	08566

Device	W = 300	W = 400	W = 650	W = 800
Plain door	08513	08514	08516	08518
Transparent door	-	08534	08536	08538

Dimensions	W = 300 mm	W = 400 mm	W = 650 mm	W = 800 mm
Rear panels	08733	08734	08736	08738

Dimensions	D = 400 mm		D = 600 mm	
Side panels	08750		08760	

Dimensions	W = 300 mm	W = 400 mm	W = 650 mm	W = 800 mm
Plain roof	08433	08434	08436	08438
Plain roof	08633	08634	08636	08638
D = 600 mm				

Plan the distribution system

See page G-1

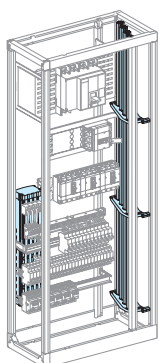

DD385317.eps

Linery LGY busbars

1 See page G-4

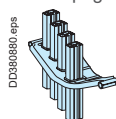

DD380890.eps

Linery BW busbars

2

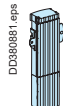

DD380881.eps

Intensity (A)	Linery LGY profiles for table	IP ≤ 31	IP > 31	Number of busbars supports									
				Icw (kA rms/1s)	25	30	40	50	60	65	75	85	
630	04502		04503										
800	04503		04504										
1000	04504			3									

Designation C	at. No.
Busbar support	04851

Linery BW busbars	160 A	250 A	400 A	630 A
3P	W = 1000 mm LVS04111	LVS04112	LVS04113	LVS04114
	W = 1400 mm LVS04116	LVS04117	LVS04118	LVS04119
4P	W = 1000 mm LVS04121	LVS04122	LVS04123	LVS04124
	W = 1400 mm LVS04126	LVS04127	LVS04128	LVS04129

Functional units

Contents

Circuit breakers

MasterPacT MTZ2	
Cables connection	E-2
Canalis connection	E-4
Dedicated cubicle	E-6
Partial front plate support frames	E-8
MasterPacT MTZ1	
Toggle and motor mechanism - Cables connection	E-10
Dedicated cubicle 3P	E-12
ComPacT NS1600b to 3200	
Cables connection	E-14
ComPacT NS630b to NS1600	
Canalis connection	E-16
Horizontal mounting	E-17
Dedicated cubicle	E-18
ComPacT, ComPacT Vigi (ELCB) and VigiComPacT NSX	
NSX 100 to 630 - Horizontal mounting	E-20
NSX 400/630 - Vertical mounting	E-25
NSX 100 to 630 - Vertical mounting W = 400 mm	E-30
NSX 100/160/250 - Vertical mounting	E-31
ComPacT NSXm up to 160	
Horizontal mounting, vertical mounting, modular devices	E-35

Switch-disconnectors

ComPacT INS-INV630b to 2500	
Vertical fixed mounting	E-39
ComPacT INS-INV250 to 630	
Horizontal / Vertical fixed mounting	E-40

Source-changeover

MasterPacT MTZ1 06/16	E-41
MasterPacT MTZ2 08/32	E-42
ComPacT NS630b to 1000	E-49
ComPacT NSX100/630	E-50
ComPacT INS-INV250 to 630 - Front direct rotary handle	E-52
ComPacT INS-INV250 to 630 - Complete assembly device	E-53

Changeover System

TransferPacT	
TransferPacT Frame 100A	E-54
TransferPacT Frame 160A	E-55
TransferPacT Frame 250A	E-56
TransferPacT Frame 630A	E-57

Fusegear

Fupact ISFL	E-58
-------------	------

Fusegear/Switch-disconnector

Fupact ISFT	E-59
Fupact GS	E-60

Others

Power factor correction equipment	E-61
Industrial control devices	E-62
Modular devices	
Acti 9 ≤ 63 A, 80/160 A switchboard incomer	E-63
Metering (Single-phase and 3-phase kilowatt-hour meters)	E-65
Human-switchboard interface (PowerLogic™ Meters)	E-67

MasterPacT MTZ2 08 to 32

Cables connection

Fixed, withdrawable

Circuit breakers

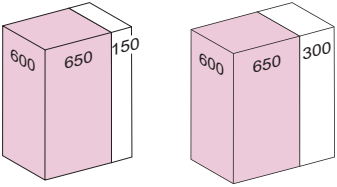
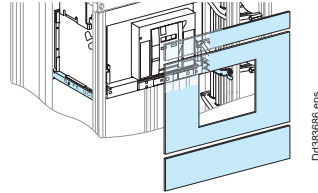
Mounting		Front connection			
					
Devices		Fixed device		Withdrawable device	
		MTZ2 08/16	MTZ2 20/32	MTZ2 08/16	MTZ2 20/32
Number of devices per row		1	1	1	1
No. of vertical modules (1)		18	19	19	20
Mounting plates		LVS03500	LVS03500	LVS03500	LVS03500
Front plates [No. of vertical modules]	upstream	LVS03804 [4]	LVS03805 [5]	LVS03804 [4]	LVS03805 [5]
	with cut-out	LVS03711 [9]	LVS03711 [9]	LVS03710 [10]	LVS03710 [10]
	downstream	LVS03805 [5]	LVS03805 [5]	LVS03805 [5]	LVS03805 [5]

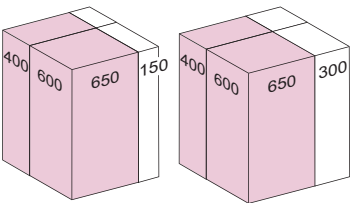
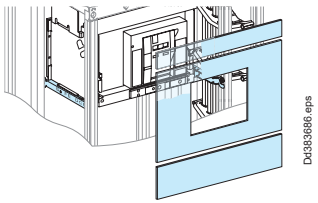
Mounting		Rear connection			
					
Devices		Fixed device		Withdrawable device	
		MTZ2 08/16	MTZ2 20/32	MTZ2 08/16	MTZ2 20/32
Number of devices per row		1	1	1	1
No. of vertical modules		14	14	15	15
Mounting plates		LVS03500	LVS03500	LVS03500	LVS03500
Front plates [No. of vertical modules]	with cut-out	LVS03711 [9]	LVS03711 [9]	LVS03710 [10]	LVS03710 [10]
	downstream	LVS03805 [5]	LVS03805 [5]	LVS03805 [5]	LVS03805 [5]

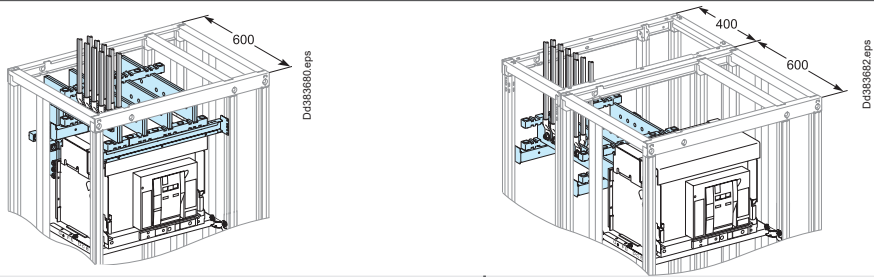
Connection		Upstream on incomer	
			
Devices		Fixed device	Withdrawable device
		MTZ2 08/32	MTZ2 08/32
Type of terminals	Vertical rear connections supplied with the device		
Connection	must be made (2)		
Front connection	bar supports	2 x LVS04694 + LVS04678	
	cables cover	LVS04861	
Rear connection	bar supports	2 x LVS04694	
	cables cover	LVS04863	

(1) For downstream connection with copper.

For downstream prefabricated connection with Linergy LGYE, 1 additional module is required only for MTZ2 3200A. Select downstream plain front plate (LVS03806).



(2) Connection to be made according to the busbar drawings supplied by Schneider Electric.

MasterPacT MTZ2 08 to 32

Cables connection

Fixed, withdrawable

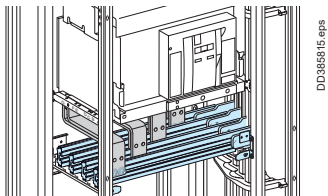
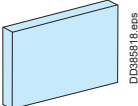
Circuit breakers

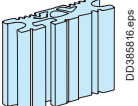
Distribution		Downstream on Linergy LGY, LGYE or BS busbars					
							
Devices		Fixed and withdrawable MTZ2 08/16		Fixed and withdrawable MTZ2 20/25		Fixed and withdrawable MTZ2 32	
		3P	4P	3P	4P	3P	4P
Type of terminals		Front connections supplied with the device.					
For vertical busbar Linergy BS 	Connection	Must be made according to the busbar drawings supplied by Schneider Electric.					
	Joint	-	-	Order one joint per phase: 1 joint for busbars, W = 50/60 mm (LVS04640), 1 joint for busbars, W = 80/100 mm (LVS04641).			
	Free support	2 x LVS04662 For I _{cw} ≥ 75 kA rms, add an additional free support LVS04662.					
	Cover	LVS04926 + LVS04927					
For vertical busbar Linergy LGY 	Connection	LVS04493	LVS04494	must be made according to the busbar drawings supplied by Schneider Electric.			
	Joint	LVS04683	LVS04684	-			
	Free support	-	-	2 x LVS04662 For I _{cw} ≥ 75 kA rms, add an additional free support LVS04662.			
	Cover	LVS04925 + LVS04928		LVS04926 + LVS04927			
For vertical busbar Linergy LGYE (1) 	Connection	-	-	LVS04495	LVS04496	LVS04497 (2)	LVS04498 (2)
	Joint	-	-	3 x LVS04685	4 x LVS04685	3 x LVS04687	4 x LVS04687
	Cover	LVS04925 + LVS04928					

- (1) For LGYE 08/25, use a duct W = 150 mm. For LGYE 32/40, use a duct W = 300 mm.
- (2) One additional module is required, select LVS03806 plain front plate for downstream.

Note: to make measurements:

Install the CTs preferably upstream, on the supply terminal extension bars or install the CTs on the horizontal busbars (busbar connection). In this case, add one module and a plain front plate (LVS03801) or install a Micrologic control unit capable of displaying the values.

Selection of busbars: Linergy LGY > page G-4, Linergy LGYE > page G-5, Linergy BS > page G-6.

MasterPacT MTZ2 08 to 32

Canalis connection

Fixed, withdrawable

Circuit breakers

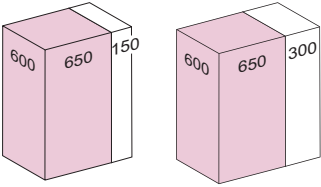
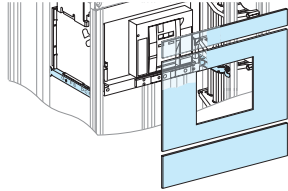
Mounting		Front connection			
					
Devices		Fixed device		Withdrawable device	
		MTZ2 08/16	MTZ2 20/32	MTZ2 08/16	MTZ2 20/32
Number of devices per row		1	1	1	1
No. of vertical modules (1)		27	28	27	28
Mounting plates		LVS03500	LVS03500	LVS03500	LVS03500
Front plates [No. of vertical modules]	upstream	LVS03805 [5] 2 x LVS03804 [8]	2 x LVS03805 [10] LVS03804 [4]	3 x LVS03804 [12]	LVS03805 [5] 2 x LVS03804 [8]
	with cut-out	LVS03711 [9]	LVS03711 [9]	LVS03710 [10]	LVS03710 [10]
	downstream	LVS03805 [5]	LVS03805 [5]	LVS03805 [5]	LVS03805 [5]

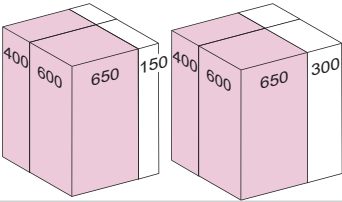
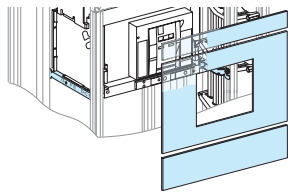
Mounting		Rear connection			
					
Devices		Fixed device		Withdrawable device	
		MTZ2 08/16	MTZ2 20/32	MTZ2 08/16	MTZ2 20/32
Number of devices per row		1	1	1	1
No. of vertical modules		16	16	17	17
Mounting plates		LVS03500	LVS03500	LVS03500	LVS03500
Front plates [No. of vertical modules]	upstream	LVS03804 [4] + LVS03803 [3]	LVS03804 [4] + LVS03803 [3]	LVS03804 [4] + LVS03803 [3]	LVS03804 [4] + LVS03803 [3]
	with cut-out	LVS03711 [9]	LVS03711 [9]	LVS03710 [10]	LVS03710 [10]

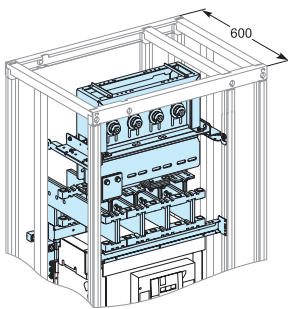
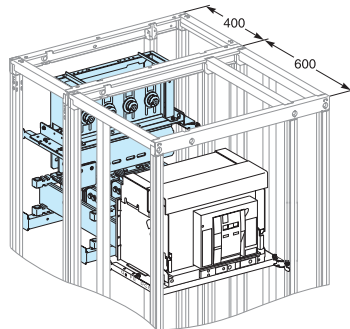
Connection		Upstream on incomer											
													
Devices		Fixed device			Withdrawable device								
		MTZ2 08/16	MTZ2 20/25	MTZ2 32	MTZ2 08/16	MTZ2 20/25	MTZ2 32	MTZ2 08/16	MTZ2 20/25	MTZ2 32	MTZ2 32		
Type of terminals		Vertical rear connections supplied with the device											
Canalis support		LVS03561											
Canalis interface (2)		3P	4P	3P	4P	3P	4P	3P	4P	3P	4P	3P	4P
		LVS04715	LVS04716	LVS04725	LVS04726	LVS04735	LVS04736	LVS04715	LVS04716	LVS04725	LVS04726	LVS04735	LVS04736
Front connection	Bar supports	2 x LVS04694 + LVS04678											
	Extension bars	must be made (3)											
	Canalis Cover	LVS04871 + LVS04861											
Rear connection	Bar supports	2 x LVS04694											
	Extension bars	must be made (3)											
	Canalis Cover	LVS04871 + LVS04863											

(1) For downstream connection with copper.

For downstream prefabricated connection with Linergy LGYE, 1 additional module is required only for MTZ2 3200A. Select downstream plain front plate (LVS03806).

(2) To tight the screws of the Canalis interface use the special tool 87808.



(3) Connection to be made according to the busbar drawings supplied by Schneider Electric.

MasterPacT MTZ2 08 to 32

Canalis connection

Fixed, withdrawable

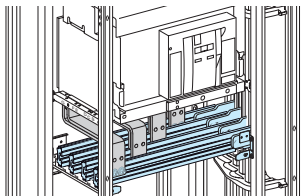
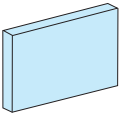
Circuit breakers

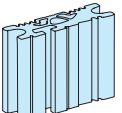
Distribution		Downstream on Linergy LGY, LGYE or BS busbars					
							
Fixed / withdrawable devices		MTZ2 08/16		MTZ2 20/25		MTZ2 32	
		3P	4P	3P	4P	3P	4P
Type of terminals		Front connections supplied with the device.					
	Connection	Must be made according to the busbar drawings supplied by Schneider Electric.					
	Joint	-	-	Order one joint per phase: 1 joint for busbars, W = 50/60 mm (LVS04640), 1 joint for busbars, W = 80/100 mm (LVS04641).			
	Free support	2 x LVS04662 For I _{cw} ≥ 75 kA rms, add an additional free support LVS04662 .					
	Cover	LVS04926 + LVS04927					
	Connection	LVS04493	LVS04494	must be made according to the busbar drawings supplied by Schneider Electric.			
	Joint	LVS04683	LVS04684	-			
	Free support	-	-	2 x LVS04662 For I _{cw} ≥ 75 kA rms, add an additional free support LVS04662 .			
	Cover	LVS04925 + LVS04928		LVS04926 + LVS04927			
	Connection	-	-	LVS04495	LVS04496	LVS04497 (2)	LVS04498 (2)
	Joint	-	-	3 x LVS04685	4 x LVS04685	3 x LVS04687	4 x LVS04687
	Cover	LVS04925 + LVS04928					

(1) For LGYE 08/25, use a duct W = 150 mm. For LGYE 32/40, use a duct W = 300 mm.

(2) One additional module is required, select **LVS03806** plain front plate for downstream.

Note: to make measurements:

Install the CTs preferably upstream, on the supply terminal extension bars or install the CTs on the horizontal busbars (busbar connection). In this case, add one module and a plain front plate (**LVS03801**) or install a Micrologic control unit capable of displaying the values.

Selection of busbars: Linergy LGY > page G-4, Linergy LGYE > page G-5, Linergy BS > page G-6.

MasterPacT MTZ2 08 to 40

Dedicated cubicle - W = 650 mm

Fixed, withdrawable

Circuit breakers

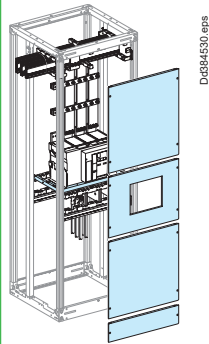
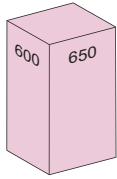

Mounting Dedicated cubicle

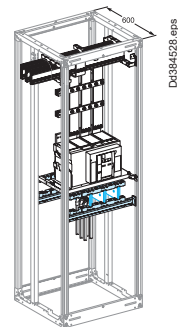

Devices	Fixed device		Withdrawable device	
	MTZ2 08/32	MTZ2 40 (2)	MTZ2 08/32	MTZ2 40 (2)
Number of devices per row	1	(2)	1	(2)
No. of vertical modules	36	(2)	36	(2)
Mounting plates	LVS03500	(2)	LVS03500	(2)
Front plates [No. of vertical modules]	upstream (1)	LVS03808 [12]	LVS03808 [12]	(2)
	with cut-out	LVS03711 [9]	LVS03710 [10]	(2)
	downstream	LVS03808 [12] + LVS03803 [3]	LVS03808 [12] + LVS03802 [2]	(2)

Connection Upstream with bottom cables

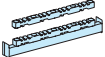

Fixed / withdrawable devices	MTZ2 08/32	MTZ2 40 (2)
Type of terminals 	Vertical rear connectors	(2)
Terminal extension bars for connection 	must be made (3)	(2)
Terminal extension bar supports 	LVS04694 x 2	(2)
Cables cover	LVS04861	(2)

- (1) One or two 3-module front plates for 72 x 72 and 96 x 96 mm measurement devices can be installed just above the cut-out front plate:
- 2 3-module front plates + 1 plain front plate LVS03806 (6 modules)
- (2) Contact Schneider Electric for 4000 A dedicated cubicle.
- (3) Connection to be made according to the busbar drawings supplied by Schneider Electric.



Human-switchboard interface > page E-66.

MasterPacT MTZ2 08 to 40

Dedicated cubicle - W = 650 mm

Fixed, withdrawable

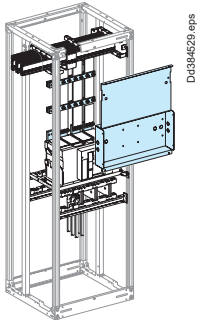
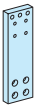
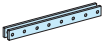
Circuit breakers

Distribution	Downstream up links on horizontal busbars						
	Linergy LGYE				Linergy BS		
							
Fixed / withdrawable devices	MTZ2 08/16	MTZ2 20/25	MTZ2 32	MTZ2 40 (1)	MTZ2 08/25	MTZ2 32	MTZ2 40 (1)
Type of terminals 	Front connection				Front connection		
Spacing rods for flat bars 	LVS04690 x 2	LVS04690 x 2	LVS04690 x 2	-	LVS04690 x 2	LVS04690 x 2	-
Connection	Connection must be made (2)				Connection must be made (2)		
	horizontal 3200 A mouting hardware	-	-	-	LVS04637 (3)	LVS04637 (3)	-
Busbar cover (4) 	LVS04860	LVS04860	LVS04860	-	LVS04860	LVS04860	-

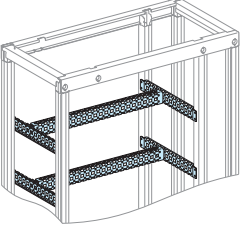
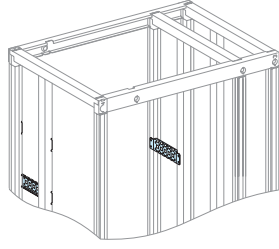
Accessories	
	
	
	Cross-members
Catalog number	LVS03584
Characteristics	Set of 2 For 650 mm wide and 400 mm deep cubicle
	LVS03586
	Set of 2 W = 200 mm, can be added to the 400 mm cross-members for frameworks that are 600 mm deep. They can also be installed separately

- (1) Contact Schneider Electric for 4000 A dedicated cubicle.
- (2) Connection to be made according to the busbar drawings supplied by Schneider Electric.
- (3) Catalog number LVS04637 includes 1 connection only. Order 1 connection per phase.
- (4) The cover is compulsory behind front plates designed for measurement devices.

MasterPacT MTZ2 08 to 32

Partial front plate support frames

Withdrawable

Circuit breakers

Mounting | **Front connection with cables in dedicated cubicle**

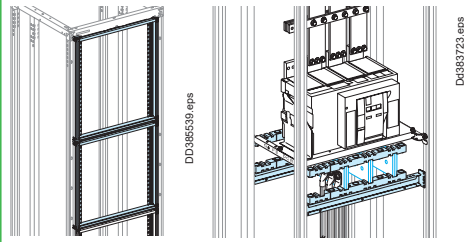
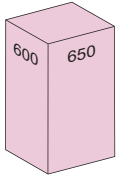

Devices	Withdrawable device	
	MTZ2 08/32	
No. of vertical modules	36 (3)	
Mounting plates	LVS03500	
Front plates [No. of vertical modules]	upstream	2 x LVS03806 [12]
	with cut-out	LVS03709 [10]
	downstream	2 x LVS03806 [12]
1/3 front plate support frame	LVS08560 (1) + 2 x LVS08562 (2)	
Cover	LVS04861	

Mounting | **Canalis front connection**

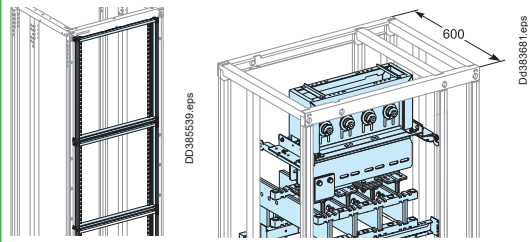
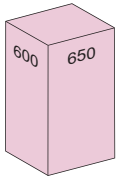

Devices	Withdrawable device	
	MTZ2 08/16	MTZ2 20/32
No. of vertical modules	27 (3)	28 (3)
Mounting plates	LVS03500	LVS03500
Front plates [No. of vertical modules]	upstream	3 x LVS03804 [12]
	with cut-out	LVS03709 [10]
	downstream	LVS03804 [4]
1/3 front plate support frame	LVS08560 (1) + 2 x LVS08562 (2)	LVS08560 (1) + 2 x LVS08562 (2)
Cover	LVS04861	LVS04861

MasterPacT MTZ2 08 to 32

Partial front plate support frames

Withdrawable

Circuit breakers

Mounting | **Rear connection with cables**

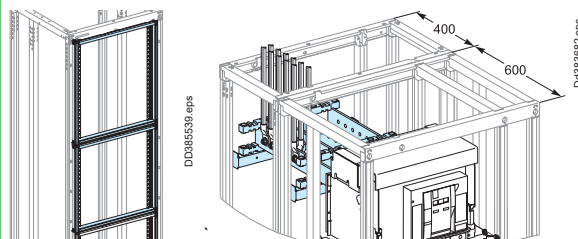
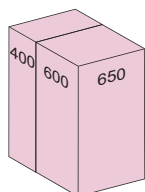

Devices	Withdrawable device	
	MTZ2 08/32	
No. of vertical modules	15 (3)	
Mounting plates	LVS03500	
Front plates	upstream	-
[No. of vertical modules]	with cut-out	LVS03709 [10]
	downstream	LVS03804 [4]
1/3 front plate support frame	LVS08560 (1) + 2 x LVS08562 (2)	

- (1) 1/3 front plate support frame 10 modules.
- (2) 1/3 front plate support frame 12 modules.
- (3) Modularity includes the space of one module between each front plate support frame.



MasterPacT MTZ1 06 to 16

Cables connection

Toggle, motor mechanism - Fixed, withdrawable

Circuit breakers

Mounting		Front connection with cables			
Devices		Fixed device		Withdrawable device	
		MTZ1 06/10		MTZ1 12/16	
Number of devices per row		1		1	
No. of vertical modules		12		13	
Mounting plates		LVS03484		LVS03483	
Front plates [No. of vertical modules]	upstream	LVS03802 [2]	LVS03804 [4]	LVS03802 [2]	LVS03804 [4]
	with cut-out	LVS03692 [7]	LVS03692 [7]	LVS03691 [8]	LVS03691 [8]
	downstream	LVS03803 [3]	LVS03803 [3]	LVS03803 [3]	LVS03803 [3]

Mounting		Rear connection with cables			
Devices		Fixed device		Withdrawable device	
		MTZ1 06/16		MTZ1 06/16	
Number of devices per row		1		1	
No. of vertical modules		11		11	
Mounting plates		LVS03484		LVS03483	
Front plates [No. of vertical modules]	upstream	LVS03801 [1]	-	-	
	with cut-out	LVS03692 [7]	LVS03691 [8]	LVS03691 [8]	
	downstream	LVS03803 [3]	LVS03803 [3]	LVS03803 [3]	

Connection		Upstream on incomer							
Devices		Fixed device				Withdrawable device			
		MTZ1 06/10		MTZ1 12/16		MTZ1 06/10		MTZ1 12/16	
		3P 4P		3P 4P		3P 4P		3P 4P	
Front connection	type of terminals	Front connections supplied with the device							
	vert. connection adapters	33642 (1)	33643 (1)	33642 (1)	33643 (1)	33642 (1)	33643 (1)	33642 (1)	33643 (1)
	cable-lug adapters	Direct		33644 (1)	33645 (1)	Direct		33644 (1)	33645 (1)
	spacing rods	-		LVS04691		-		LVS04691	
	arc-chute cover	47335	47336	47335	47336	-			
	cables cover	LVS04852							
Rear connection	type of terminals	Vertical rear connections supplied with the device							
	terminal extension bar	2 x LVS04693							
	support								
	cables cover	LVS04854							
	extension bars	must be made (2)							

Distribution		Downstream on Linergy LGY or BS busbars							
Devices		Fixed device				Withdrawable device			
		MTZ1 06/12		MTZ1 16		MTZ1 06/12		MTZ1 16	
		3P 4P		3P 4P		3P 4P		3P 4P	
Type of terminals		Front connections supplied with the device							
Prefabricated connection to busbars	Linergy LGY	LVS04475	LVS04476	LVS04489	LVS04490	LVS04477	LVS04478	LVS04491	LVS04492
	Linergy BS	must be made (2)							
Cover for busbars connection		add free supports: 2 x LVS04662							
		LVS04926							

(1) Vertical connection adapters and cable-lug adapters and CT, are not compatible with input voltage ≥ 440V due to mandatory barriers installation (33648 or 33768)

(2) Connection to be made according to the busbar drawings supplied by Schneider Electric.

Note: to make measurements: install the CTs on the horizontal busbars (busbar connection); in this case, an additional module is required; add a plain front plate (LVS03801) or install a Micrologic control unit capable of displaying the values.

Selection of busbars: Linergy LGY > page G-4, Linergy LGYE > page G-5, Linergy BS > page G-6.

MasterPacT MTZ1 06 to 16

Canalis connection

Toggle, motor mechanism - Fixed, withdrawable

Circuit breakers

Mounting Canalis front connection

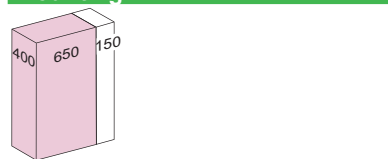

Devices	Fixed device		Withdrawable device	
	MTZ1 06/12	MTZ1 16	MTZ1 06/12	MTZ1 16
Number of devices per row	1	-	1	-
No. of vertical modules	17	-	18	-
Mounting plates	LVS03484	-	LVS03483	-
Front plates	upstream LVS03804 [4] + LVS03803 [3]	-	LVS03804 [4] + LVS03803 [3]	-
[No. of vertical modules]	with cut-out LVS03692 [7]	-	LVS03691 [8]	-
	downstream LVS03803 [3]	-	LVS03803 [3]	-

Mounting Canalis rear connection

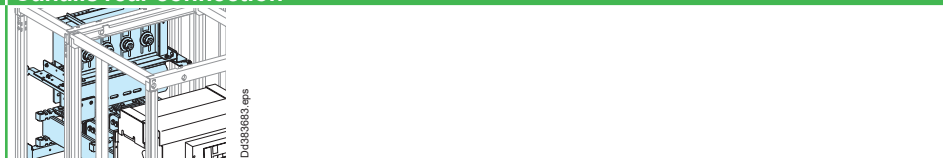
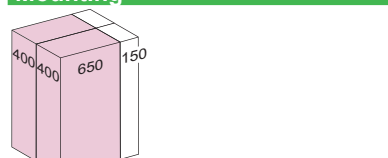

Devices	Fixed device		Withdrawable device	
	MTZ1 06/16	MTZ1 16	MTZ1 06/16	MTZ1 16
Number of devices per row	1	-	1	-
No. of vertical modules	16	-	16	-
Mounting plates	LVS03484	-	LVS03483	-
Front plates	upstream LVS03806 [6]	-	LVS03805 [5]	-
[No. of vertical modules]	with cut-out LVS03692 [7]	-	LVS03691 [8]	-
	downstream LVS03803 [3]	-	LVS03803 [3]	-

Connection Upstream on incomer



Devices	Fixed device				Withdrawable device			
	MTZ1 06/12		MTZ1 16		MTZ1 06/12		MTZ1 16	
	3P	4P	3P	4P	3P	4P	3P	4P
Canalis support	LVS03561				-			
Canalis interface (1)	LVS04703	LVS04704	LVS04703	LVS04704	LVS04703	LVS04704	LVS04703	LVS04704
Front connection	Front connections supplied with the device							
Type of terminals	-							
Canalis/device connection	LVS04711	LVS04712	-	-	LVS04711	LVS04712	-	-
Arc-chute cover	47335	47336	-	-	-	-	-	-
Canalis cover	LVS04871 + LVS04852				LVS04871 + LVS04852			
Rear connection	Vertical rear connections supplied with the device							
Type of terminals	-							
Terminal extension bar support	2 x LVS04693				-			
Canalis/device connection	LVS04713	LVS04714	LVS04713	LVS04714	LVS04713	LVS04714	LVS04713	LVS04714
Cable cover	LVS04871 + LVS04854							
Extension bars	must be made (2)							

Distribution Downstream on Linergy LGY or BS busbars

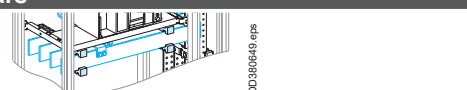

Devices	Fixed device				Withdrawable device			
	MTZ1 06/12		MTZ1 16		MTZ1 06/12		MTZ1 16	
	3P	4P	3P	4P	3P	4P	3P	4P
Type of terminals	Front connections supplied with the device							
Prefabricated connection to busbars	Linergy LGY LVS04475	Linergy BS LVS04476	LVS04489	LVS04490	LVS04477	LVS04478	LVS04491	LVS04492
	must be made (2)							
	add free supports: 2 x LVS04662							
Cover for busbars connection	LVS04926							

(1) To tight the screws of the Canalis interface use the special tool 87808.
 (2) Connection to be made according to the busbar drawings supplied by Schneider Electric.
Note: to make measurements: install the CTs on the horizontal busbars (busbar connection); in this case, an additional module is required; add a plain front plate (LVS03801) or install a Micrologic control unit capable of displaying the values.
 Selection of busbars: Linergy LGY > page G-4, Linergy LGYE > page G-5, Linergy BS > page G-6.

MasterPacT MTZ1 06 to 16

Dedicated cubicle 3P - W = 400 mm

Fixed, withdrawable

Circuit breakers

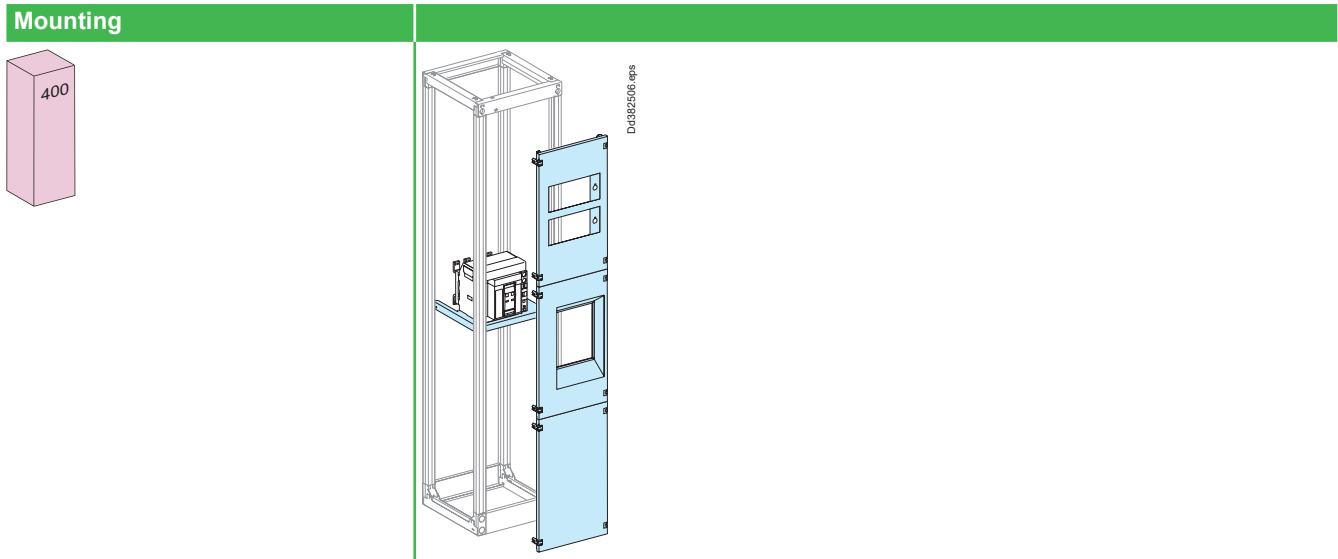

Devices	Fixed device	Withdrawable device
	MTZ1 06 to MTZ1 16	
Number of devices per cubicle	1	1
No. of vertical modules	37	37
Mounting plates	LVS03489	LVS03488
Front plates	LVS03698 [11]	LVS03699 [11]
[No. of vertical modules]	with cut-out upstream (1) cut-out for 72 x 72 or 96 x 96 mm	LVS03723 [13]
	or plain	LVS03722 [13]
	downstream (1) plain	LVS03722 [13]
		LVS03722 [13]

Measurement-device installation

Measurement devices are installed on a front plate (**LVS03723**) using plastic mounting plates with cut-outs. The front plate can hold:

- six 72 x 72 mm cases
- or four 96 x 96 mm cases + 2 switches
- or two 96 x 96 mm cases + 2 switches (2)

Number and type of devices per row	Metal front plate with cut-out	No. of vertical modules	Plastic mounting plates with cut-out	Blanking plate or device support
------------------------------------	--------------------------------	-------------------------	--------------------------------------	----------------------------------

Mounting on interface with plastic mounting plates

3 x 72 x 72 Vigirex and other devices 72 x 72 without switch		13			To blank-off or install: - from 1 to 4 buttons Ø 16 or 22 mm - 1 device 45 x 45
2 x 96 x 96 Power Meter and others devices 96 x 96					To blank-off or install: - 1 to 4 buttons Ø 16 or 22 mm - 1 device 45 x 45 - 1 device 72 x 72
1 x (2) For PM200, 200P, PM5 & PM8 series meters			LVS03723	LVS03903	LVS03901

Characteristics	<ul style="list-style-type: none"> ■ Installation of three devices (72 x 72 mm cases) using plastic mounting plates (LVS03902) and two devices (96 x 96 mm cases) + a switch using plastic mounting plates (LVS03903) on a hinged front plate (LVS03723) ■ The plain mounting plates have knock-outs for lamps, pushbuttons, switches or devices. Knock-outs for LVS03900: 4 Ø 16 mm, 5 Ø 22 mm or one for a 45 x 45 mm device. Knock-outs for LVS03901: 4 Ø 16 mm, 5 Ø 22 mm or one for a 45 x 45 or 72 x 72 mm device.
-----------------	---



(1) Hinged or reversible (left or right-hand opening) front plates connect directly to the framework, without a front-plate support frame.
 (2) For PM200, 200P, PM5 & PM 8 series meters, use 1 no. blank-off sheet with each meter in a row.

MasterPacT MTZ1 06 to 16

Dedicated cubicle 3P - W = 400 mm



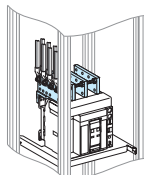
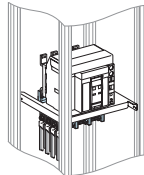
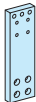

Fixed, withdrawable

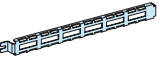
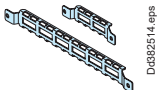
Circuit breakers

Connection	Upstream on incomer	
	 D4382072_1.eps	 D4382069.eps
Devices	Fixed device	Withdrawable device
	MTZ1 06 to MTZ1 16	
Type of terminals 	Front connection	Front connection
Arc-chute cover 	47335	-
Vert. conn. adapters	33642 (1)	33642 (1)
Cable-lug adapters	33644 (1)	33644 (1)
Spacing rods 	LVS04691	LVS04691

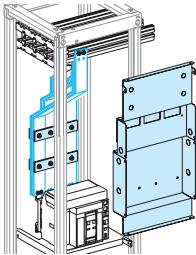
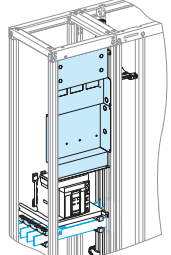
Accessories		
	 D48825 13.eps	 D48825 14.eps
	W = 400	D = 400 D = 600
4 cable tie supports for framework	LVS08774	LVS08794 LVS08794 + LVS08796

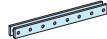
(1) Vertical connection adapters and cable-lug adapters are not compatible with input voltage ≥ 500 V.

Distribution	Downstream on horizontal busbars		Downstream on vertical busbars
	Linergy LGYE	Linergy BS	Linergy LGY or BS
	 D0385890.eps		 D0385814.eps
Fixed / withdrawable devices	MTZ1 06 to MTZ1 16		MTZ1 06 to MTZ1 16
Type of terminals 	Front connection	Front connection	Front connection
Support 	2 x LVS04692 For MTZ1 H1 & H2 3 x LVS04692 For MTZ1 H3	2 x LVS04692 For MTZ1 H1 & H2 3 x LVS04692 For MTZ1 H3	LVS04662
Barrier (1) 	LVS04855	LVS04855	LVS04855
Horizontal-busbar connections	must be made (2)	must be made (2)	-
10 mm thickness bars	-	LVS04636 (3)	-
Vertical-busbar connections	-	-	must be made (2)
Free support	-	-	LVS04662

(1) A barrier must be installed behind front plate LVS03723 when measurement devices are installed.

(2) Connection to be made according to the busbar drawings supplied by Schneider Electric.

(3) Catalog number LVS04636 includes 1 connection only. Order 1 connection per phase.

ComPacT NS1600b to 3200

Cables connection

Fixed

Circuit breakers

Mounting Front connection

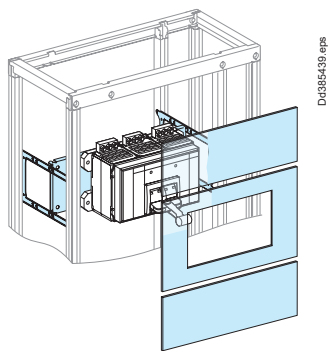
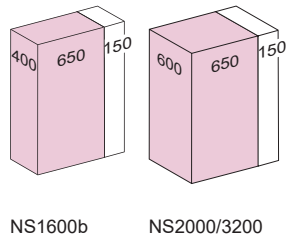

Devices		Fixed device	
		NS1600b	NS2000/3200
Number of devices per row		1	1
No. of vertical modules		14	16
Mounting plates		LVS03501	LVS03501
Front plates [No. of vertical modules]	upstream	LVS03802 [2]	LVS03802 [2]
	with cut-out	LVS03716 [8]	LVS03716 [8]
	downstream	LVS03804 [4]	LVS03806 [6]

Connection Upstream on incomer

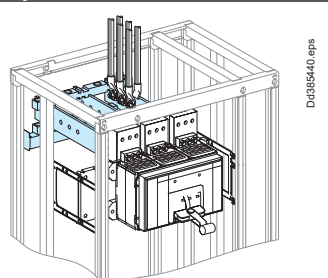

Fixed devices		NS1600b/2500	NS3200
Type of terminals		Front connections supplied with the device	
Vertical-connection adapters	3P	33975	33975
	4P	33976	33976
Terminal extension bar support		LVS04694	
Extension bars		must be made (1)	

Distribution Downstream on Linergy LGY, LGYE or BS busbars

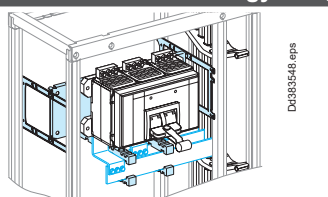

Fixed devices		NS1600b	NS2000/2500	NS3200
Type of terminals		Front connections supplied with the device		
Busbars connection		must be made (1) (2)		
Free support for busbars connection		2 x LVS04662		
Cover for busbars connection		LVS04926	LVS04926	LVS04926
Additional cover		-	LVS04927	LVS04927

(1) Connection to be made according to the busbar drawings supplied by Schneider Electric. LGYE: +17.5 mm than BS.

(2) For the connection to flat busbars > 1600 A, order one joint per phase:

- 1 joint for busbars, W = 50/60 mm (LVS04640)
- 1 joint for busbars, W = 80/100 mm (LVS04641)

Note: to make measurements:

- install the CTs on the horizontal busbars (busbar connection); in this case, an additional module is required; add a plain front plate (LVS03801)
- or install a Micrologic control unit capable of displaying the values.

Selection of busbars: Linergy LGY > page G-4, Linergy LGYE > page G-5, Linergy BS > page G-6.

ComPacT NS630b to NS1600

Cables connection

Toggle, rotary handle, motor mechanism - Fixed, withdrawable

Circuit breakers

Mounting		Front connection with cables			
Devices		Fixed device		Withdrawable device	
		NS630b/1000	NS1250/1600	NS630b/1000	NS1250/1600
Number of devices per row		1	1	1	1
No. of vertical modules		12	14	13	15
Mounting plates		LVS03482	LVS03482	LVS03483	LVS03483
Front plates		upstream LVS03802 (2)	LVS03804 (4)	LVS03802 (2)	LVS03804 (4)
[No. of vertical modules]		with cut-out LVS03690 or LVS03701 (1) (7)		LVS03691 (8)	LVS03691 (8)
		downstream LVS03803 (3)	LVS03803 (3)	LVS03803 (3)	LVS03803 (3)

Mounting		Rear connection with cables	
Devices		Fixed device	Withdrawable device
		NS630b/1600	NS630b/1600
Number of devices per row		1	1
No. of vertical modules		10	11
Mounting plates		LVS03482	LVS03483
Front plates		with cut-out LVS03690 or LVS03701 (1) (7)	LVS03691 (8)
[No. of vertical modules]		downstream LVS03803 (3)	LVS03803 (3)

Connection		Upstream on incomer							
		Fixed device				Withdrawable device			
		NS630b/1000		NS1250/1600		NS630b/1000		NS1250/1600	
		3P	4P	3P	4P	3P	4P	3P	4P
Front connection		Front connections supplied with the device							
Type of terminals		Vertical connection adapters							
Vertical connection adapters		33642 (3)	33643 (3)	33642 (3)	33643 (3)	33642 (3)	33643 (3)	33642 (3)	33643 (3)
Cable-lug adapters		Direct		33644 (3)	33645 (3)	Direct		33644 (3)	33645 (3)
Spacing rods		-		LVS04691 (3)		-		LVS04691 (3)	
Arc-chute cover		33596	33597	33596	33597	-		-	
Cables cover		LVS04851				LVS04852			
Rear connection		Vertical rear connections supplied with the device							
Type of terminals		Terminal extension bar support							
Terminal extension bar support		2 x LVS04693							
Cables cover		LVS04853				LVS04854			
Extension bars		must be made (2)							

Connection		Downstream distribution via Linergy LGY or BS busbars							
		Fixed device				Withdrawable device			
		NS630b/1250		NS1600		NS630b/1250		NS1600	
		3P	4P	3P	4P	3P	4P	3P	4P
Type of terminals		Front connections supplied with the device							
Busbars connection		For Linergy LGY busbars: prefabricated connection							
		LVS04485	LVS04486	LVS04487	LVS04488	LVS04477	LVS04478	LVS04491	LVS04492
		For Linergy BS busbars: must be made (2).							
Free support for busbars connection		For Linergy BS busbars: 2 x LVS04662							
Cover for busbars connection		LVS04926							

- (1) For devices with toggle or rotary handle catalog number LVS03690, with a motor mechanism catalog number LVS03701.
- (2) Connection to be made according to the busbar drawings supplied by Schneider Electric.
- (3) Vertical connection adaptaters and cable-lug adapters and CT, are not compatible with input voltage ≥ 500V due to mandatory barriers installation (33648 or 33768).

Note: to make measurements:

- install a Micrologic control unit capable of displaying the values.
- or install the CTs on the horizontal busbars; in this case, an additional module is required; add a plain front plate downstream (LVS03801).

Selection of busbars: Linergy LGY > page G-4, Linergy LGYE > page G-5, Linergy BS > page G-6.

ComPacT NS630b to 1600

Canalis connection

Toggle, rotary handle, motor mechanism - Fixed, withdrawable

Circuit breakers

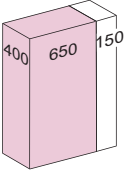
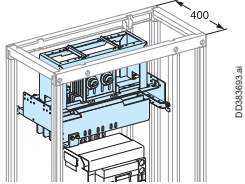
Mounting		Canalis front connection			
					
Devices		Fixed device		Withdrawable device	
		NS630b/1250	NS1600	NS630b/1250	NS1600
Number of devices per row		1	-	1	-
No. of vertical modules		17	-	18	-
Mounting plates		LVS03482	-	LVS03483	-
Front plates		LVS03804 [4] + LVS03803 [3]	-	LVS03804 [4] + LVS03803 [3]	-
[No. of vertical modules]		LVS03690 or LVS03701 (1) [7]	-	LVS03691 [8]	-
upstream		LVS03803 [3]	-	LVS03803 [3]	-
with cut-out		-	-	-	-
downstream		-	-	-	-

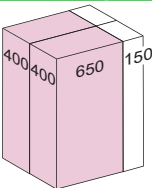
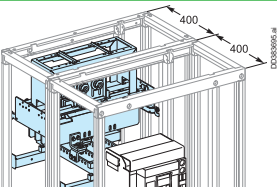
Mounting		Canalis rear connection			
					
Devices		Fixed device		Withdrawable device	
		NS630b/1600		NS630b/1600	
Number of devices per row		1		1	
No. of vertical modules		16		16	
Mounting plates		LVS03482		LVS03483	
Front plates		LVS03806 [6]		LVS03805 [5]	
[No. of vertical modules]		LVS03690 or LVS03701 (1) [7]		LVS03691 [8]	
upstream		LVS03803 [3]		LVS03803 [3]	
with cut-out		-		-	
downstream		-		-	

Connection		Upstream on incomer			
Devices		Fixed device		Withdrawable device	
		NS630b/1600		NS630b/1600	
		3P	4P	3P	4P
Canalis support		LVS03561	-	-	-
Canalis interface (2)		LVS04703	LVS04704	LVS04703	LVS04704
Front connection		Front connections supplied with the device			
Type of terminals		LVS04711	LVS04712	LVS04711	LVS04712
Canalis/device		33596	33597	-	-
Arc-chute cover		LVS04871 + LVS04851		LVS04871 + LVS04852	
Canalis cover		Vertical rear connections supplied with the device			
Rear connection		2 x LVS04693			
Type of terminals		must be made (3)			
Terminal extension bar support		-		LVS04713	LVS04714
Extension bars		-		LVS04871 + LVS04854	
Canalis/device connection		-		LVS04713	
Canalis cover		LVS04871 + LVS04854		LVS04714	

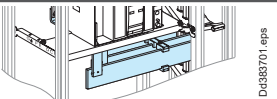
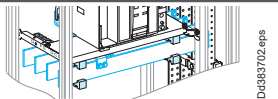
Connection		Downstream distribution via Linergy LGY or BS busbars							
									
Devices		Fixed device				Withdrawable device			
		NS630b/1250		NS1600		NS630b/1250		NS1600	
		3P	4P	3P	4P	3P	4P	3P	4P
Type of terminals		Front connections supplied with the device							
Busbars connection		For Linergy LGY busbars: prefabricated connection							
		LVS04485	LVS04486	LVS04487	LVS04488	LVS04477	LVS04478	LVS04491	LVS04492
		Can be reversed for upstream supply							
		For Linergy BS busbars: must be made (3)							
Free support for busbars connection		For Linergy BS busbars: 2 x LVS04662							
Cover for busbars connection		LVS04926							

(1) For devices with toggle or rotary handle catalog number LVS03690, with a motor mechanism catalog number LVS03701.

(2) To tight the screws of the Canalis interface use the special tool 87808.

(3) Connection to be made according to the busbar drawings supplied by Schneider Electric.

Note: to make measurements:

■ install a Micrologic control unit capable of displaying the values.

■ or install the CTs on the horizontal busbars; in this case, an additional module is required; add a plain front plate downstream (LVS03801).

Selection of busbars: Linergy LGY > page G-4, Linergy LGYE > page G-5, Linergy BS > page G-6.

ComPacT NS630b to 1000

Horizontal mounting

Toggle, rotary handle - Fixed

Circuit breakers

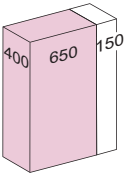
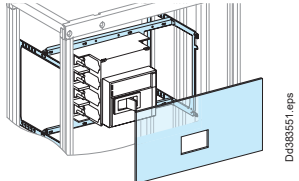
Mounting	Front connection
	
Devices	Fixed device NS630b/1000
Number of devices per row	1
No. of vertical modules	7 (1)
Mounting plates	LVS03480
Front plates with cut-outs	LVS03687

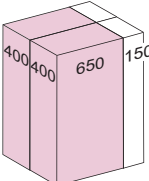
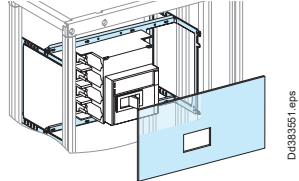
Mounting	Rear connection
	
Devices	Fixed device NS630b/1000
Number of devices per row	1
No. of vertical modules	7 (1)
Mounting plates	LVS03480
Front plates with cut-outs	LVS03687

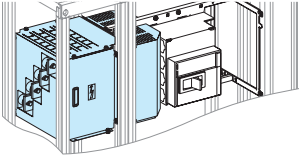
Connection	Upstream on incomer
	
Fixed devices	NS630b/1000 3P 4P
Type of terminals	front connection Front connections supplied with the device rear connection Vertical rear connections supplied with the device
Connection transfer assembly for front connection	LVS04483 LVS04484 If cubicle w300 mm then 3x300 mm ² , if cubicle w400 mm then 4x300 mm ² , same concept for 185 mm ² . Three 300 mm ² or six 185 mm ² cables can be connected per phase with lugs that are not of the two-metal type.
Cover rear connection	-

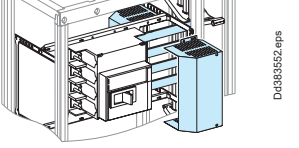
Connection	Downstream via Linergy LGY, LGYE or BS busbars
	
Fixed devices	NS630b/1000 3P 4P
Type of terminals	Front connections supplied with the device
Busbars connection	For Linergy LGY busbars: prefabricated connection LVS04473 LVS04474 must be made. For Linergy LGYE (> page G-13) and Linergy BS busbars
Cover for busbars connection	LVS04842
Arc-chute cover	33596 33597

(1) Mounting of LVS03480 + connection transfer assembly LVS04483 or LVS04484 needs 8 vertical modules (use of one complementary front plate 1 module LVS03801) at the bottom of the functional unit.

Selection of busbars: Linergy LGY > page G-4, Linergy LGYE > page G-5, Linergy BS > page G-6.

ComPacT NS630b to 1600

Dedicated cubicle - W = 400 mm

Fixed, withdrawable

Circuit breakers

Mounting Toggle, rotary handle and motor mechanism

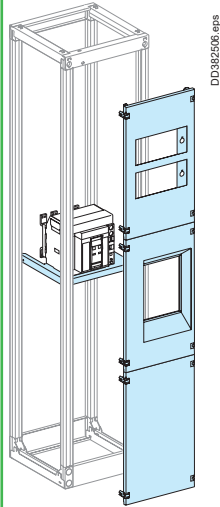
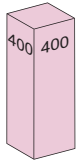

Devices	Fixed device	Withdrawable device
	NS630b/1600 3/4P	NS630b/1600 3P
Number of devices per cubicle	1	1
No. of vertical modules	37	37
Mounting plates	LVS03487	LVS03488
Front plates	with cut-out	LVS03697 [11]
[No. of vertical modules]	upstream (1) with cut-out for 72 x 72 or 96 x 96 mm meters	LVS03723 [13]
	or plain	LVS03722 [13]
	downstream (1) plain	LVS03722 [13]

Measurement-device installation

Measurement devices are installed on a front plate (**LVS03723**) using plastic mounting plates with cut-outs. The front plate can hold:

- six 72 x 72 mm cases
- or four 96 x 96 mm cases + 2 switches.

Number and type of devices per row	Metal front plate with cut-out	No. of vertical modules	Plastic mounting plates with cut-out	Blanking plate or device support
------------------------------------	--------------------------------	-------------------------	--------------------------------------	----------------------------------



Mounting on an interface with plastic mounting plates				
3 x 72 x 72 Vigirex and other devices 72 x 72 without switch		13		<p>To blank-off or install: - from 1 to 4 buttons Ø 16 or 22 mm - 1 device 45 x 45</p>
2 x 96 x 96 Power Meter and other devices 96 x 96 with switch				<p>To blank-off or install: - from 1 to 4 buttons Ø 16 or 22 mm - 1 device 45 x 45 - 1 device 72 x 72</p>
Characteristics	LVS03723		LVS03903	LVS03901
	<ul style="list-style-type: none"> ■ Installation of three devices (72 x 72 mm cases) using plastic mounting plates (LVS03902) and two devices (96 x 96 mm cases) + a switch using plastic mounting plates (LVS03903) on a hinged front plate (LVS03723) ■ The plain mounting plates have knock-outs for lamps, pushbuttons, switches or devices. Knock-outs for LVS03900: 4 Ø 16 mm, 5 Ø 22 mm or one for a 45 x 45 mm device. Knock-outs for LVS03901: 4 Ø 16 mm, 5 Ø 22 mm or one for a 45 x 45 or 72 x 72 mm device. 			

(1) Hinged or reversible (left or right-hand opening) front plates connect directly to the framework, without a front-plate support frame.

ComPacT NS630b to 1600

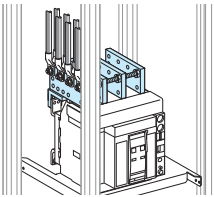
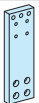

Dedicated cubicle - W = 400 mm
Fixed, withdrawable

Circuit breakers

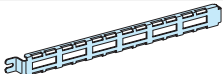
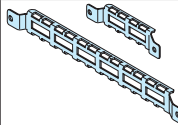
Connection		Upstream on incomer	
			
Devices		Fixed device	
		NS630b/1600	
		3P	4P
Type of terminals		Front connection	
Arc-chute cover		33596	33597
Vert. conn. adapters		33642 (1)	33643 (1)
Cable-lug adapters		33644 (1)	33645 (1)
Spacing rods		LVS04691	
		Withdrawable device	
		3P	
		Front connection	

Accessories			
			
		W = 400	D = 400
4 cable tie supports for framework		LVS08774	LVS08794
			D = 600
			LVS08794 + LVS08796

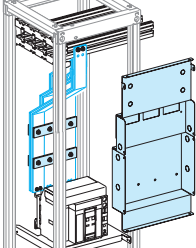
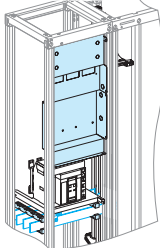
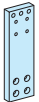
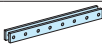
(1) Vertical connection adapters and cable-lug adapters are not compatible with input voltage ≥ 500 V.

Distribution	Connection to horizontal busbars				Connection to vertical busbars		
	Linergy LGYE		Linergy BS		Linergy LGY or BS		
							
Devices		Fixed	Withdrawable	Fixed	Withdrawable	Fixed	Withdrawable
		NS630b/1600	NS630b/1600	NS630b/1600	NS630b/1600	NS630b/1600	NS630b/1600 3P
		3P/4P	3P	3P/4P	3P	3P/4P	3P
Type of terminals		Front connection	Front connection	Front connection	Front connection	Front connection	Front connection
Support		2 x LVS04692	2 x LVS04692	2 x LVS04692	2 x LVS04692	-	-
Barrier (1)		LVS04855	LVS04855	LVS04855	LVS04855	LVS04855	LVS04855
Horizontal-busbar connections		must be made (2)		-	-	-	-
	50/60/80	-	-	LVS04636 (3)	LVS04636	-	-
Vertical-busbar connections		-	-	-	-	must be made (2)	
Free support		-	-	-	-	LVS04662	

(1) A barrier must be installed behind front plate **LVS03723** when measurement devices are installed.

(2) Connection to be made according to the busbar drawings supplied by Schneider Electric.

(3) Catalog number **LVS04636** includes 1 connection only. Order 1 connection per phase.

Connection device/horizontal busbar to make by customer.

Busbar selection Linergy BS to make connection: > page G-3 and page G-6.

Busbar selection Linergy LGYE or LGY: > page G-2 and page G-4.

ComPacT, ComPacT Vigi (ELCB) and VigiComPacT NSX 100 to 630

Horizontal mounting

Toggle - Fixed

Designed for PowerTag NSX
Circuit breakers

Mounting Horizontal fixed

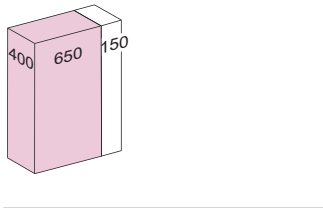

Devices	Toggle					
	NSX (1) / NSX Vigi (ELCB) (1) / Vigi NSX 100/160/250		NSX (1) / NSX Vigi (ELCB) (1) 400/630		Vigi NSX 400/630	
	3P	4P	3P	4P	3P	4P
Number of devices per row	1	1	1	1	1	1
PowerTag NSX compatibility	↯	↯	↯	↯	-	-
No. of vertical modules	3	4	4	5	4	5
Mounting plates	LVS03411	LVS03412	LVS03451	LVS03452	LVS03451	LVS03452
Front plates with cut-out	LVS03604 (2)	LVS03606 (2)	LVS03643	LVS03644	LVS03643	LVS03644

Connection Upstream from lateral busbars

Fixed devices	NSX / NSX Vigi (ELCB) / Vigi NSX 100/160/250		NSX / NSX Vigi (ELCB) / Vigi NSX 400/630	
	3P	4P	3P	4P

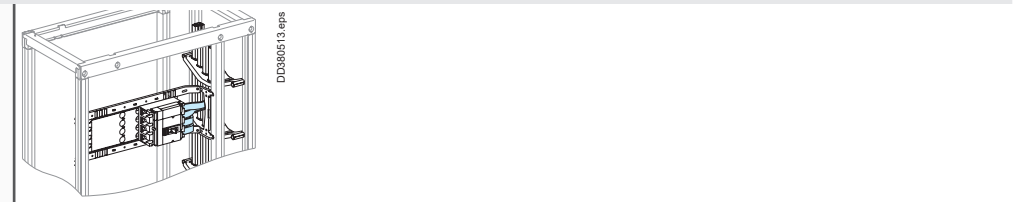
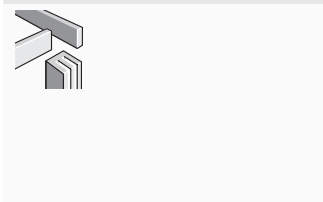

Prefabricated connection	LVS04423 (4)	LVS04424 (4)	LVS04453	LVS04454
--------------------------	--------------	--------------	----------	----------

Connection Linergy BS, LGYE



Connection	must be made (3)			
Long terminal shields	LV429517	LV429518	LV432593	LV432594

Connection Downstream distribution

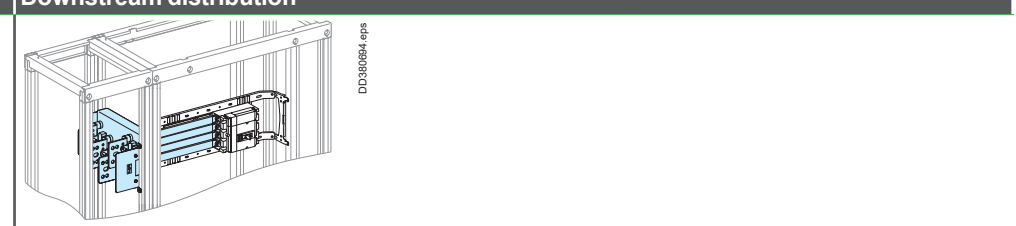
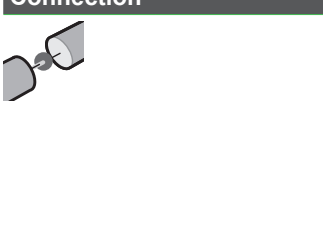

Fixed devices	NSX / NSX Vigi (ELCB) 100/250		Vigi NSX100/250		NSX / NSX Vigi (ELCB) 400/630		Vigi NSX400/630		
	3P	4P	3P	4P	3P	4P	3P	4P	
Front connection	LV429517	LV429518	LV429517	LV429518	LV432593	LV432594	LV432593	LV432594	
Connection transfer assembly	connection	LVS04425	LVS04426	LVS04429 (5)	LVS04430 (5)	LVS04455	LVS04456	LVS04459 (5)	LVS04460 (5)
	connection with PowerTag NSX	LVS04425	LVS04426	-	-	LVS04459 (5)	LVS04460 (5)	-	-
Rear connection	long terminal shields	-	-	LV429517	LV429518	-	-	LV432593	LV432594
	short terminal shields	LV429515 (4)	LV429516 (4)	LV429515 (4)	LV429516 (4)	LV432591 (4)	LV432592 (4)	LV432591 (4)	LV432592 (4)
	short rear connectors	LV429235		LV429235		LV432475		LV432475	
	long rear connectors	LV429236		LV429236		LV432476		LV432476	

(1) Metering and signaling features (ammeter...) can be added. Mounted on a ComPacT NSX, it has the same size than a ComPacT Vigi NSX. Refer to the corresponding column.
 (2) Compatible with FDM121.
 (3) Connections must be made with insulated flexible bars > page G-20.
 (4) Compatible with Linergy LGYE vertical busbar.
 (5) Complete the connection with insulated flexible bars (not supplied).

ComPacT, ComPacT Vigi (ELCB) and VigiComPacT NSX 100 to 630

Horizontal mounting

Toggle - Plug-in

Circuit breakers

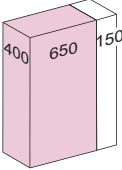
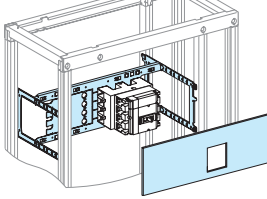
Mounting	Horizontal plug-in			
				

Devices	Toggle			
	NSX (1) / NSX Vigi (ELCB) (1) / Vigi NSX 100/160/250		NSX (1) / NSX Vigi (ELCB) (1) / Vigi NSX 400/630	
	3P	4P	3P	4P
Number of devices per row	1	1	1	1
No. of vertical modules	3	4	4	5
Mounting plates	LVS03413 (5)	LVS03414 (5)	LVS03453	LVS03454
Front plates	with cut-out LVS03604 (2)	LVS03606 (2)	LVS03643	LVS03644

Connection	Upstream from lateral busbars			
Plug-in devices	NSX / NSX Vigi (ELCB) / Vigi NSX 100/160/250		NSX / NSX Vigi (ELCB) / Vigi NSX 400/630	
	3P	4P	3P	4P

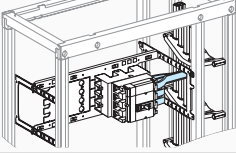
Linery LGY				
				
Prefabricated connection	LVS04431 (3)	LVS04432 (3)	LVS04461	LVS04462
Short terminal shields on device	LV429515	LV429516	LV432591	LV432592

Linery BS, LGYE				
				
Connection	must be made with insulated flexible bars > page G-20.			
Connection adapter for plug-in base	LV429306	LV429307	LV432584	LV432585
Long terminal shields on plug-in base	LV429517	LV429518	LV432593	LV432594
Short terminal shields on device	LV429515	LV429516	LV432591	LV432592

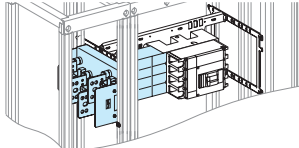
Connection	Downstream distribution			
				
Plug-in devices	NSX / NSX Vigi (ELCB) / Vigi NSX 100/160/250		NSX / NSX Vigi (ELCB) / Vigi NSX 400/630	
	3P	4P	3P	4P
Front connection	connection adapter for plug-in base LV429306	LV429307	LV432584	LV432585
	short terminal shields on device LV429515	LV429516	LV432591	LV432592
	long terminal shields on plug-in base LV429517	LV429518	LV432593	LV432594
Connection transfer assembly	connection LVS04429 (4)	LVS04430 (4)	LVS04459 (4)	LVS04460 (4)
	connection adapter for plug-in base LV429306	LV429307	LV432584	LV432585
	short terminal shields LV429515	LV429516	LV432591	LV432592
	long terminal shields LV429517	LV429518	LV432593	LV432594
Rear connection	short terminal shields 2 x LV429515	2 x LV429516	2 x LV432591	2 x LV432592
	short rear connectors LV429235	LV429235	LV432475	LV432475
	long rear connectors LV429236	LV429236	LV432476	LV432476
	connection adapter for plug-in base LV429306	LV429307	LV432584	LV432585

- (1) Metering and signaling features (ammeter...) can be added. Mounted on a ComPacT NSX, it has the same size than a ComPacT Vigi NSX. Refer to the corresponding column.
- (2) Compatible with FDM121.
- (3) Compatible with Linery LGYE vertical busbar.
- (4) Complete the connection with insulated flexible bars (not supplied).
- (5) Precut not to be removed for rotary handle & motor mechanism.

ComPacT, ComPacT Vigi (ELCB) and VigiComPacT NSX 100 to 630

Horizontal mounting

Rotary handle, motor mechanism - Fixed

Designed for PowerTag NSX
Circuit breakers



Mounting Horizontal Fixed

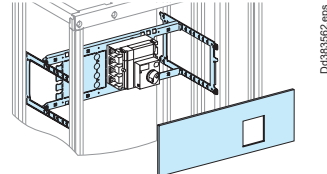
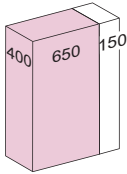

D0383562.eps

Devices	Rotary handle, motor mechanism										
	NSX (1) / NSX Vigi (ELCB) (1) 100/160/250		Vigi NSX 100/160/250		NSX (1) / NSX Vigi (ELCB) (1) 400/630				Vigi NSX 400/630		
	3P	4P	3P	4P	rotary handle		motor mechanism		rotary handle		
Number of devices per row	1	1	1	1	1	1	1	1	1	1	1
PowerTag NSX compatibility	⊘	⊘	⊘	⊘	⊘	⊘	⊘	⊘	-	-	-
No. of vertical modules	3	4	3	4	4	5	4	5	4	5	-
Mounting plates	LVS03413 (6)	LVS03414 (6)	LVS03413 (6)	LVS03414 (6)	LVS03453	LVS03454	LVS03453	LVS03454	LVS03453	LVS03454	-
Fixing kit for control support	-	-	-	-	-	-	LVS03460	LVS03460	-	-	-
Front plates with cut-out	LVS03604 (2)	LVS03606 (2)	LVS03604 (2)	LVS03606 (2)	LVS03643	LVS03644	LVS03643	LVS03644	LVS03643	LVS03644	-
Collar	-	-	LV429285	LV429285	-	-	LV429285	LV429285	LV429285	LV429285	-

Connection Upstream from lateral busbars

Fixed devices	NSX / NSX Vigi (ELCB) / Vigi NSX 100/160/250		NSX / NSX Vigi (ELCB) / Vigi NSX 400/630	
	3P	4P	3P	4P

Linery LGY

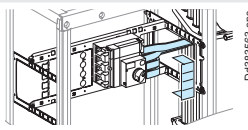

D0383563.eps

Connection	LVS04427 (3)	LVS04428 (3)	must be made with insulated flexible bars > page G-20 (4).	
Long terminal shields	-	-	LV432593	LV432594

Linery BS, LGYE

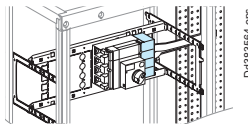

D0383564.eps

Connection	must be made with insulated flexible bars > page G-20.			
Long terminal shields	LV429517	LV429518	LV432593	LV432594

Connection Downstream distribution

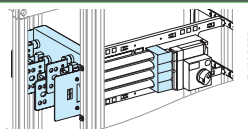

D0383565.eps

Fixed devices		NSX / NSX Vigi (ELCB) / Vigi NSX			
		100/160/250		400/630	
		3P	4P	3P	4P
Front connection	long terminal shields	LV429517	LV429518	LV432593	LV432594
Connection transfer assembly	connection with or without PowerTag NSX	LVS04429 (5)	LVS04430 (5)	LVS04459 (5)	LVS04460 (5)
Rear connection	long terminal shields	LV429517	LV429518	LV432593	LV432594
	short terminal shields	LV429515	LV429516	LV432591	LV432592
	short rear connectors	LV429235	-	LV432475	-
	long rear connectors	LV429236	-	LV432476	-

(1) Metering and signaling features (ammeter...) can be added. Mounted on a ComPacT NSX, it has the same size than a ComPacT Vigi NSX. Refer to the corresponding column.

(2) Compatible with FDM121.

(3) Compatible with Linery LGYE vertical busbar.

(4) To be made according to the busbar drawings supplied by Schneider Electric.

(5) Complete the connection with insulated flexible bars (not supplied).

(6) Precut not to be removed for rotary handle & motor mechanism.

ComPacT, ComPacT Vigi (ELCB) and VigiComPacT NSX 100 to 630

Horizontal mounting

Rotary handle, motor mechanism - Plug-in

Circuit breakers

Mounting Horizontal plug-in

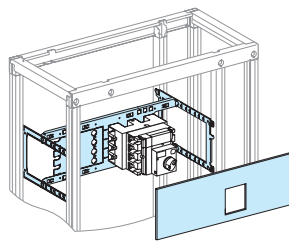
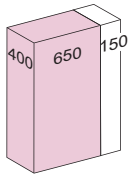

DD383865-plug-in.eps

Devices	Rotary handle, motor mechanism							
	NSX (1) / NSX Vigi (ELCB) (1) 100/160/250		Vigi NSX 100/160/250		NSX (1) / NSX Vigi (ELCB) (1) 400/630		Vigi NSX 400/630 rotary handle NSX400/630 motor mechanism	
	3P	4P	3P	4P	3P	4P	3P	4P
Number of devices per row	1	1	1	1	1	1	1	1
No. of vertical modules	3	4	3	4	4	5	4	5
Mounting plates	LVS03413 (7)	LVS03414 (7)	LVS03413 (7)	LVS03414 (7)	LVS03453 (2)	LVS03454 (2)	LVS03453 (2)	LVS03454 (2)
Front plates with cut-out	LVS03604 (3)	LVS03606 (3)	LVS03604 (3)	LVS03606 (3)	LVS03643	LVS03644	LVS03643	LVS03644
Collar	-	-	LV429285	LV429285	-	-	LV429285	LV429285

Connection Upstream from lateral busbars

Plug-in devices	NSX / NSX Vigi (ELCB) / Vigi NSX 100/160/250		NSX / NSX Vigi (ELCB) / Vigi NSX 400/630	
	3P	4P	3P	4P

Linery LGY

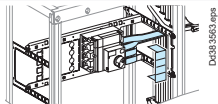

DD383483.eps

Connection	LVS04427 (4)	LVS04428 (4)	must be made with insulated flexible bars > page G-20 (5)	
Short terminal shields	LV429515	LV429516	LV432591	LV432592
Long terminal shields	-	-	LV432593	LV432594
Connection adapter for plug-in base	LV429306	LV429307	LV432584	LV432585

Linery BS, LGYE

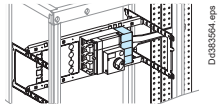

DD383564.eps

Connection	must be made with insulated flexible bars > page G-20.			
Short terminal shields	LV429515	LV429516	LV432591	LV432592
Long terminal shields	LV429517	LV429518	LV432593	LV432594
Connection adapter for plug-in base	LV429306	LV429307	LV432584	LV432585

Connection Downstream distribution

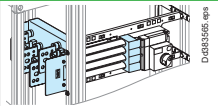

DD383656.eps

Plug-in devices	NSX / NSX Vigi (ELCB) / Vigi NSX 100/160/250		NSX / NSX Vigi (ELCB) / Vigi NSX 400/630		
	3P	4P	3P	4P	
Front connection	long terminal shields	LV429517	LV429518	LV432593	LV432594
	short terminal shields	LV429515	LV429516	LV432591	LV432592
	connection adapter for plug-in base	LV429306	LV429307	LV432584	LV432585
Connection transfer assembly	connection	LVS04429 (6)	LVS04430 (6)	LVS04459 (6)	LVS04460 (6)
	long terminal shields	LV429517	LV429518	LV432593	LV432594
	short terminal shields	LV429515	LV429516	LV432591	LV432592
Rear connection	short terminal shields	2 x LV429515	2 x LV429516	2 x LV432591	2 x LV432592
	short rear connectors	LV429235	-	LV432475	-
	long rear connectors	LV429236	-	LV432476	-
	connection adapter for plug-in base	LV429306	LV429307	LV432584	LV432585
	connection adapter for plug-in base	-	-	-	-

(1) Metering and signaling features (ammeter...) can be added. Mounted on a ComPacT NSX, it has the same size than a ComPacT Vigi NSX. Refer to the corresponding column.

(2) Catalog number LVS03460 is recommended when installing an NSX with a motor mechanism.

(3) Compatible with FDM121.

(4) Compatible with Linergy LGYE vertical busbar.

(5) To be made according to the busbar drawings supplied by Schneider Electric.

(6) Complete the connection with insulated flexible bars (not supplied).

(7) Precut not to be removed for rotary handle & motor mechanism.

ComPacT, ComPacT Vigi (ELCB) and VigiComPacT NSX 100 to 630

Horizontal mounting

All controls - Withdrawable

Circuit breakers

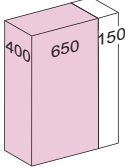
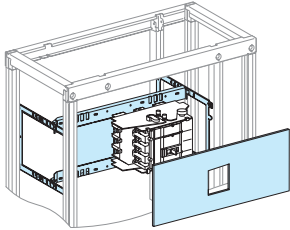
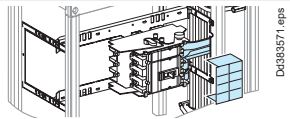
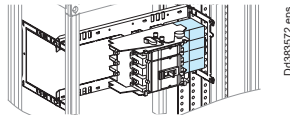
Mounting		Horizontal withdrawable			
					
Devices		All controls			
		NSX / NSX Vigi (ELCB) 100/160/250 (1)	Vigi NSX 100/160/250	NSX / NSX Vigi (ELCB) 400/630 (1)	Vigi NSX 400/630
Number of devices per row		1	1	1	1
No. of vertical modules (1)		5	5	6	6
Mounting plates		LVS03415	LVS03415	LVS03462 (2)	LVS03462 (2)
Front plates with cut-out		LVS03618	LVS03618	LVS03657	LVS03657
Collar		LV429284	LV429285	LV432534	LV429285
Locking kit (3)		LV429286	LV429286	LV429286 (4)	LV429286 (4)
Connection		Upstream from lateral busbars			
Withdrawable devices		NSX / NSX Vigi (ELCB) / Vigi NSX 100/160/250 3P		NSX / NSX Vigi (ELCB) / Vigi NSX 400/630 4P	
Linery LGY					
Prefabricated connection for toggle		LVS04431	LVS04432	LVS04461	LVS04462
Prefabricated connection for rotary handle & motor mechanism		LVS04427 (5)	LVS04428 (5)	must be made with insulated flexible bars > page G-20 (6).	
Connection adapter for plug-in base		-	-	LV432584 (7)	LV432585 (7)
Short terminal shields		LV429515	LV429516	LV432591	LV432592
Long terminal shields		-	-	LV432593 (7)	LV432594 (7)
Linery BS, LGYE					
Connection		must be made with insulated flexible bars > page G-20.			
Connection adapter for plug-in base		LV429306	LV429307	LV432584 (7)	LV432585 (7)
Short terminal shields		LV429515	LV429516	LV432591	LV432592
Long terminal shields		LV429517	LV429518	LV432593 (7)	LV432594 (7)
Connection		Downstream distribution			
Withdrawable devices		NSX / NSX Vigi (ELCB) / Vigi NSX 100/160/250 3P		NSX / NSX Vigi (ELCB) / Vigi NSX 400/630 4P	
Front connection		connection adapter for plug-in base LV429306	LV429307	LV432584	LV432585
		long terminal shields LV429517	LV429518	LV432593	LV432594
		short terminal shields LV429515	LV429516	LV432591	LV432592
Connection transfer assembly		LVS04429 (8)	LVS04430 (8)	LVS04459 (8)	LVS04460 (8)
		connection adapter for plug-in base LV429306	LV429307	LV432584	LV432585
		long terminal shields LV429517	LV429518	LV432593	LV432594
		short terminal shields LV429515	LV429516	LV432591	LV432592
Rear connection		short terminal shields 2 x LV429515	2 x LV429516	2 x LV432591	2 x LV432592
		short rear connectors LV429235	LV429235	LV432475	LV432475
		long rear connectors LV429236	LV429236	LV432476	LV432476
		connection adapter for plug-in base LV429306	LV429307	LV432584	LV432585

(1) Metering and signaling features (ammeter...) can be added. Mounted on a ComPacT NSX, it has the same size than a ComPacT Vigi NSX. Refer to the corresponding column.

(2) Catalog number LVS03460 is recommended when installing an NSX with a motor mechanism.

(3) If mounting several above one another chassis + form 3b + chassis locking kit LV429286, the number of vertical modules must be increased by 2 ; it is necessary to add a 2 modules front plate LVS03802.

(4) Not compatible with NSX630.

(5) Compatible with Linery LGYE vertical busbar.

(6) To be made according to the busbar drawings supplied by Schneider Electric.

(7) Only for Rotary handle and motor mechanism.

(8) Complete the connection with insulated flexible bars (not supplied).

ComPacT, ComPacT Vigi (ELCB) and VigiComPacT NSX 400/630

Vertical mounting

Toggle - Fixed



Designed for PowerTag NSX
Circuit breakers

Mounting Vertical fixed

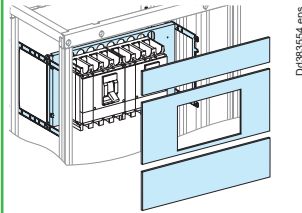
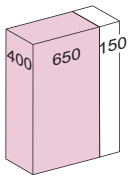

Doc83854_eps

Devices	Toggle							
	NSX / NSX Vigi (ELCB) 400 (1)		Vigi NSX 400		NSX / NSX Vigi (ELCB) 630 (1)		Vigi NSX 630	
Number of devices per row	1	2	1	2	1	2	1	2
PowerTag NSX compatibility	☺		☺		☺		☺	
No. of vertical modules	11 or 13		13 or 15		13 or 15		15 or 17	
Mounting plates	LVS03461		LVS03461		LVS03461		LVS03461	
Front plates [No. of vertical modules]	upstream	LVS03801 [1]	LVS03802 [2]	-	LVS03802 [2]	LVS03802 [2]	LVS03803 [3]	LVS03801 [1] LVS03803 [3]
	with cut-out	LVS03275 [9]	LVS03663 [7]	LVS03297 [11]	LVS03666 [9]	LVS03275 [9]	LVS03663 [7]	LVS03297 [11] LVS03666 [9]
	downstream	LVS03801 [1]	LVS03802 [2]	LVS03802 [2]	LVS03802 [2]	LVS03802 [2]	LVS03803 [3]	LVS03801 [1] LVS03802 [2] LVS03803 [3]
	downstream with PowerTag NSX	LVS03803 [3]	LVS03804 [4]	LVS03804 [4]	LVS03804 [4]	LVS03804 [4]	LVS03805 [5]	LVS03803 [3] LVS03805 [5]

Connection Upstream from lateral busbars - Linergy LGY, BS, LGYE



Fixed devices	NSX / NSX Vigi (ELCB) / Vigi NSX 400		NSX / NSX Vigi (ELCB) / Vigi NSX 630	
	3P	4P	3P	4P
Front connection	must be made with insulated flexible bars > page G-20. (2)			
long terminal shields	LV432593	LV432594	LV432593	LV432594
Rear connection	short terminal shields		LV432591	
short rear connectors	LV432475		LV432475	
long rear connectors	LV432476		LV432476	

Connection Downstream distribution

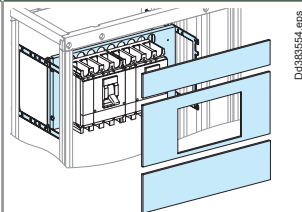

Doc83854_eps

Fixed devices	NSX / NSX Vigi (ELCB) / Vigi NSX 400		NSX / NSX Vigi (ELCB) / Vigi NSX 630	
	3P	4P	3P	4P
Front connection	long terminal shields		LV432593	
long terminal shields	LV432593		LV432594	
Rear connection (3)	short terminal shields		LV432591	
short rear connectors	LV432475		LV432475	
long rear connectors	LV432476		LV432476	

(1) Metering and signaling features (ammeter...) can be added. Mounted on a ComPacT NSX, it has the same size than a ComPacT Vigi NSX. Refer to the corresponding column.
 (2) Connection to be made according to the busbar drawings supplied by Schneider Electric.
 (3) Size reduced to one module downstream.





ComPacT, ComPacT Vigi (ELCB) and VigiComPacT NSX 400/630

Vertical mounting

Toggle - Plug-in

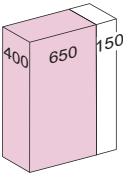
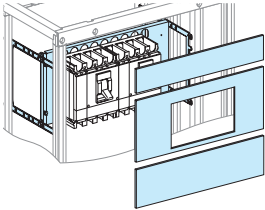
Circuit breakers

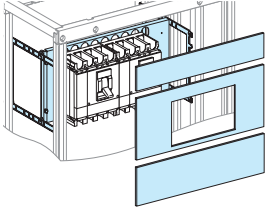
Mounting		Vertical plug-in							
									
Devices		Toggle							
		NSX / NSX Vigi (ELCB) 400 (1)		Vigi NSX 400		NSX / NSX Vigi (ELCB) 630 (1)		Vigi NSX 630	
Number of devices per row		1	2	1	2	1	2	1	2
Mounting plates		LVS03461		LVS03461		LVS03461		LVS03461	
Front plates [No. of vertical modules]	upstream	LVS03801 [1]	LVS03802 [2]	-	LVS03802 [2]	LVS03802 [2]	LVS03803 [3]	LVS03801 [1]	LVS03803 [3]
	with cut-out	LVS03275 [9]	LVS03663 [7]	LVS03297 [11]	LVS03666 [9]	LVS03275 [9]	LVS03663 [7]	LVS03297 [11]	LVS03666 [9]
	downstream	LVS03801 [1]	LVS03802 [2]	LVS03802 [2]	LVS03802 [2]	LVS03802 [2]	LVS03803 [3]	LVS03803 [3]	LVS03803 [3]
Connection		Upstream from lateral busbars - Linergy LGY, BS, LGE							
									
Plug-in devices		NSX / NSX Vigi (ELCB) / Vigi NSX 400				NSX / NSX Vigi (ELCB) / Vigi NSX 630			
		3P		4P		3P		4P	
Front connection		must be made with insulated flexible bars > page G-20.(2)							
long terminal shields		LV432593		LV432594		LV432593		LV432594	
short terminal shields		LV432591		LV432592		LV432591		LV432592	
connection adapter for plug-in base		LV432584		LV432585		LV432584		LV432585	
Rear connection	short terminal shields	2 x LV432591		2 x LV432592		2 x LV432591		2 x LV432592	
	short rear connectors	LV432475		LV432475		LV432475		LV432475	
	long rear connectors	LV432476		LV432476		LV432476		LV432476	
	connection adapter for plug-in base	LV432584		LV432585		LV432584		LV432585	
Connection		Downstream distribution							
									
Plug-in devices		NSX / NSX Vigi (ELCB) / Vigi NSX 400				NSX / NSX Vigi (ELCB) / Vigi NSX 630			
		3P		4P		3P		4P	
Front connection	connection adapter for plug-in base	LV432584		LV432585		LV432584		LV432585	
	short terminal shields on device	LV432591		LV432592		LV432591		LV432592	
	long terminal shields on plug-in base	LV432593		LV432594		LV432593		LV432594	
Rear connection (3)	short terminal shields	2 x LV432591		2 x LV432592		2 x LV432591		2 x LV432592	
	short rear connectors	LV432475		LV432475		LV432475		LV432475	
	long rear connectors	LV432476		LV432476		LV432476		LV432476	
	connection adapter for plug-in base	LV432584		LV432585		LV432584		LV432585	

(1) Metering and signaling features (ammeter...) can be added. Mounted on a ComPacT NSX, it has the same size than a ComPacT Vigi NSX. Refer to the corresponding column.

(2) Connection to be made according to the busbar drawings supplied by Schneider Electric.

(3) Size reduced to one module downstream.

ComPacT, ComPacT Vigi (ELCB) and VigiComPacT NSX 400/630

Vertical mounting

Rotary handle, motor mechanism - Fixed



Designed for PowerTag NSX
Circuit breakers

Mounting Vertical fixed

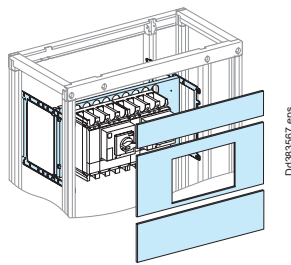
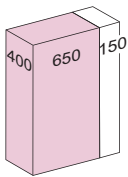

Devices		Rotary handle, motor mechanism							
		NSX / NSX Vigi (ELCB) 400 (1)		Vigi NSX 400 Rotary handle		NSX / NSX Vigi (ELCB) 630 (1)		Vigi NSX 630 Rotary handle	
Number of devices per row		1	2	1	2	1	2	1	2
PowerTag NSX compatibility		⊘		⊘		⊘		⊘	
No. of vertical modules		11 or 13		13 or 15		13 or 15		15 or 17	
Mounting plates		LVS03461 (2)		LVS03461		LVS03461 (2)		LVS03461	
Front plates [No. of vertical modules]	upstream	LVS03801 [1]	LVS03802 [2]	-	LVS03802 [2]	LVS03802 [2]	LVS03803 [3]	LVS03801 [1]	LVS03803 [3]
	with cut-out	LVS03275 [9]	LVS03663 [7]	LVS03297 [11]	LVS03666 [9]	LVS03275 [9]	LVS03663 [7]	LVS03297 [11]	LVS03666 [9]
	downstream	LVS03801 [1]	LVS03802 [2]	LVS03802 [2]	LVS03802 [2]	LVS03802 [2]	LVS03803 [3]	LVS03803 [3]	LVS03803 [3]
	downstream with PowerTag NSX	LVS03803 [3]	LVS03804 [4]	LVS03804 [4]	LVS03804 [4]	LVS03804 [4]	LVS03805 [5]	LVS03805 [5]	LVS03805 [5]
Collar		-		LV429285		-		LV429285	
IP40 escutcheons		-		LV429316 (3)		-		LV429316 (3)	

Connection Upstream from lateral busbars - Linergy LGY, BS, LGYE



Fixed devices		NSX / NSX Vigi (ELCB) / Vigi NSX 400/630	
		3P	4P
Front connection		must be made with insulated flexible bars > page G-20 (4)	
	long terminal shields	LV432593	LV432594
Rear connection	short terminal shields	LV432591 (5)	LV432592 (5)
	short rear connectors	LV432475	
	long rear connectors	LV432476	

Connection Downstream distribution



Fixed devices		NSX / NSX Vigi (ELCB) / Vigi NSX 400/630	
		3P	4P
Front connection	long terminal shields	LV432593	LV432594
	short terminal shields	LV432591	LV432592
Rear connection (4)	short rear connectors	LV432475	
	long rear connectors	LV432476	

(1) Metering and signaling features (ammeter...) can be added. Mounted on a ComPacT NSX, it has the same size than a ComPacT Vigi NSX. Refer to the corresponding column.

(2) Catalog number LVS03460 is recommended when installing an NSX with a motor mechanism.

(3) For ammeter, take LV429285 + LV429318 catalog numbers.

(4) Connection to be made according to the busbar drawings supplied by Schneider Electric.

(5) Size reduced to one module downstream.

ComPacT, ComPacT Vigi (ELCB) and VigiComPacT NSX 400/630

Vertical mounting

Rotary handle, motor mechanism - Plug-in

Circuit breakers

Mounting Vertical plug-in

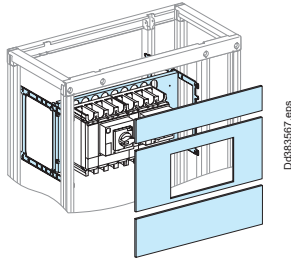
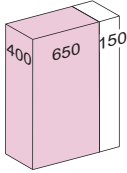

Devices	Rotary handle, motor mechanism								
	NSX / NSX Vigi (ELCB) 400 (1)		Vigi NSX400 Rotary handle		NSX / NSX Vigi (ELCB) 630 (1)		Vigi NSX630 Rotary handle		
Number of devices per row	1	2	1	2	1	2	1	2	
No. of vertical modules	11		13		13		15		
Mounting plates	LVS03461 (2)		LVS03461		LVS03461 (2)		LVS03461		
Front plates [No. of vertical modules]	upstream	LVS03801 [1]	LVS03802 [2]	-	LVS03802 [2]	LVS03802 [2]	LVS03803 [3]	LVS03801 [1]	LVS03803 [3]
	with cut-out	LVS03275 [9]	LVS03663 [7]	LVS03297 [11]	LVS03666 [9]	LVS03275 [9]	LVS03663 [7]	LVS03297 [11]	LVS03666 [9]
	downstream	LVS03801 [1]	LVS03802 [2]	LVS03802 [2]	LVS03802 [2]	LVS03802 [2]	LVS03803 [3]	LVS03803 [3]	LVS03803 [3]
Collar	-		LV429285		-		LV429285		
IP40 front-panel escutcheons	-		LV429316 (3)		-		LV429316 (3)		

Connection Upstream from lateral busbars - Linergy LGY, BS, LGYE



Plug-in devices		NSX / NSX Vigi (ELCB) / Vigi NSX 400/630	
		3P	4P
Front connection	connection	must be made with insulated flexible bars > page G-20 (4)	
	long terminal shields	LV432593	LV432594
	short terminal shields	LV432591	LV432592
	connection adapter for plug-in base	LV432584	LV432585
Rear connection	short terminal shields	2 x LV432591 (5)	2 x LV432592 (5)
	short rear connectors	LV432475	
	long rear connectors	LV432476	
	connection adapter for plug-in base	LV432584	LV432585

Connection Downstream distribution



Plug-in devices		NSX / NSX Vigi (ELCB) / Vigi NSX 400/630	
		3P	4P
Front connection	long terminal shields	LV432593	LV432594
	short terminal shields	LV432591	LV432592
	connection adapter for plug-in base	LV432584	LV432585
Rear connection (5)	short terminal shields	2 x LV432591	2 x LV432592
	short rear connectors	LV432475	
	long rear connectors	LV432476	
	connection adapter for plug-in base	LV432584	LV432585

(1) Metering and signaling features (ammeter...) can be added. Mounted on a ComPacT NSX, it has the same size than a ComPacT Vigi NSX. Refer to the corresponding column.

(2) Catalog number LVS03460 is recommended when installing an NSX with a motor mechanism.

(3) For ammeter, take LV429285 + LV429318 catalog numbers.

(4) Connection to be made according to the busbar drawings supplied by Schneider Electric.

(5) Size reduced to one module downstream.

ComPacT, ComPacT Vigi (ELCB) and VigiComPacT NSX 100 to 630

Vertical mounting

All controls - Withdrawable

Circuit breakers

Mounting		Vertical withdrawable								
Devices		All controls								
		NSX / NSX Vigi (ELCB) (1)	100/160	250	400	400 toggle	400 rotary handle + motor mechan.	630	630 toggle	630 rotary handle + motor mechan.
Number of devices per row		2	2	2	1	1	1	2	1	1
No. of vertical modules		8	9	11	11	11	11	13	13	13
Mounting plates		LVS03421	LVS03421	LVS03461 (2)	LVS03461	LVS03461 (2)	LVS03461 (2)	LVS03461 (2)	LVS03461	LVS03461 (2)
Front plates upstream		LVS03802 (2)	LVS03802 (2)	LVS03802 (2)	LVS03801 (1)	LVS03801 (1)	LVS03801 (1)	LVS03803 (3)	LVS03802 (2)	LVS03802 (2)
[No. of vertical modules]										
with cut-out		LVS03243 (5)	LVS03243 (5)	LVS03663 (7)	LVS03275 (9)	LVS03275 (9)	LVS03275 (9)	LVS03663 (7)	LVS03275 (9)	LVS03275 (9)
downstream		LVS03801 (1)	LVS03802 (2)	LVS03802 (2)	LVS03801 (1)	LVS03801 (1)	LVS03801 (1)	LVS03803 (3)	LVS03802 (2)	LVS03802 (2)
Collar		LV429284 (3)	LV429284 (3)	LV432534 (3)	LV432534	-	-	LV432534 (3)	LV432534	-

Mounting		Vertical withdrawable									
Devices		All controls									
		Vigi NSX 100/160	Vigi NSX 250	Vigi NSX 400 toggle		Vigi NSX 400 rotary handle + motor mechanism		Vigi NSX 630 toggle		Vigi NSX 630 rotary handle + motor mechanism	
Number of devices per row		2	2	1	2	1	2	1	2	1	2
No. of vertical modules		10	11	13	13	13	13	15	15	15	15
Mounting plates		LVS03421	LVS03421	LVS03461	LVS03461	LVS03461	LVS03461	LVS03461	LVS03461	LVS03461	LVS03461
Front plates upstream		LVS03802 (2)	LVS03802 (2)	-	LVS03802 (2)	-	LVS03802 (2)	LVS03801 (1)	LVS03803 (3)	LVS03801 (1)	LVS03803 (3)
[No. of vertical modules]											
with cut-out		LVS03244 (7)	LVS03244 (7)	LVS03297 (11)	LVS03666 (9)	LVS03297 (11)	LVS03666 (9)	LVS03297 (11)	LVS03666 (9)	LVS03297 (11)	LVS03666 (9)
downstream		LVS03801 (1)	LVS03802 (2)	LVS03802 (2)	LVS03802 (2)	LVS03802 (2)	LVS03802 (2)	LVS03803 (3)	LVS03803 (3)	LVS03803 (3)	LVS03803 (3)
Collar		LV429285 + LV429284 (3)	LV429285 + LV429284 (3)	LV429285 + LV432534 (3)	-	LV429285	-	LV429285 + LV432534	-	LV429285	-

Connection		Upstream from lateral busbars - Linergy LGY, BS, LGYE			
Withdrawable devices		NSX / NSX Vigi (ELCB) / Vigi NSX 100/160/250		NSX / NSX Vigi (ELCB) / Vigi NSX 400/630	
		3P	4P	3P	4P
Front conn.		must be made with insulated flexible bars > page G-20.			
long terminal shields		LV429517	LV429518	LV432593	LV432594
short terminal shields		LV429515	LV429516	LV432591	LV432592
connection adapter for plug-in base		LV429306	LV429307	LV432584	LV432585
Rear conn.					
short terminal shields		2 x LV429515	2 x LV429516	2 x LV432591	2 x LV432592
short rear connectors		LV429235	LV429235	LV432475	LV432475
long rear connectors		LV429236	LV429236	LV432476	LV432476
connection adapter for plug-in base		LV429306	LV429307	LV432584	LV432585

Connection		Downstream distribution			
Withdrawable devices		NSX / NSX Vigi (ELCB) / Vigi NSX 100/160/250		NSX / NSX Vigi (ELCB) / Vigi NSX 400/630	
		3P	4P	3P	4P
Front conn.					
connection adapter for plug-in base		LV429306	LV429307	LV432584	LV432585
short terminal shields on device		LV429515	LV429516	LV432591	LV432592
terminal shields on plug-in base		LV429517	LV429518	LV432593	LV432594
Rear conn.					
short terminal shields		2 x LV429515	2 x LV429516	2 x LV432591	2 x LV432592
short rear connectors		LV429235	LV429235	LV432475	LV432475
long rear connectors		LV429236	LV429236	LV432476	LV432476
connection adapter for plug-in base		LV429306	LV429307	LV432584	LV432585

(1) Metering and signaling features (ammeter...) can be added. Mounted on a ComPacT NSX, it has the same size than a ComPacT Vigi NSX. Refer to the corresponding column.

(2) Catalog number LVS03460 is recommended when installing an NSX with a motor mechanism.

(3) For devices with toggle only.

ComPacT, ComPacT Vigi (ELCB) and VigiComPacT NSX 100 to 630

Vertical mounting - W = 400 mm

All controls - Fixed, plug-in

Designed for PowerTag Energy 250/ 630 A
Circuit breakers



Mounting

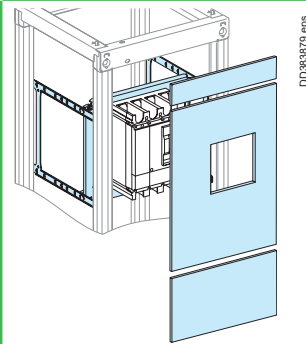
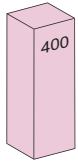

DD383879 eps

Devices	Fixed		Fixed	Fixed / Plug-in (1)	Fixed / Plug-in (1)
	NSX / NSX Vigi (ELCB) 100/250 (2)	Rotary handle Motor mechanism	Vigi NSX 100/250 Toggle	NSX / NSX Vigi (ELCB) 400/630 (2)	Vigi NSX 400/630 Toggle
Number of devices per row	1	1	1	1	1
PowerTag 250/ 630A compatibility	⌚	⌚	⌚	⌚ (1)	⌚ (1)
No. of vertical modules	9 or 10	9 or 10	11 or 12	12 or 14	14 or 16
Mounting plates	LVS03050	LVS03051	LVS03050	LVS03487	LVS03487
Adapter PrismaSeT G Active	LVS03596	LVS03596	LVS03596	-	-
Front plates with cut-out	LVS03253 [9]	LVS03253 [9]	LVS03293 [11]	LVS03283 [12]	LVS03299 [10]
[No. of vertical modules]	downstream	-	-	-	LVS03814 [4]
	downstream with PowerTag 250/ 630 A	LVS03811 [1]	LVS03811 [1]	LVS03811 [1]	LVS03812 [2]
Collar	-	-	-	LV432534	LV432534

Connection

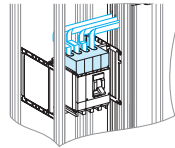

DD383814 eps

Devices	Fixed device				Plug-in device			
	NSX / NSX Vigi (ELCB) / Vigi NSX 100/160/250		400/630		NSX / NSX Vigi (ELCB) / Vigi NSX 100/160/250		400/630	
	3P	4P	3P	4P	3P	4P	3P	4P
Connection	must be made with insulated flexible bars > page G-20 and according to the drawings supplied by Schneider Electric.							
Front connection	connection adapter for plug-in base	-	-	-	LV429306	LV429307	LV432584	LV432585
	short terminal shields	-	-	-	LV429515	LV429516	LV432591	LV432592
	ong terminal shields	LV429517	LV429518	LV432593	LV432594	LV429517	LV429518	LV432593

Connection

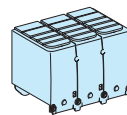

DD383921 eps

Devices	Fixed device				Plug-in device				
	NSX / NSX Vigi (ELCB) / Vigi NSX 100/160/250		400/630		NSX / NSX Vigi (ELCB) / Vigi NSX 100/160/250		400/630		
	3P	4P	3P	4P	3P	4P	3P	4P	
Front connection	short terminal shields	-	-	-	LV429515	LV429516	LV432591	LV432592	
	long terminal shields	LV429517	LV429518	LV432593	LV432594	LV429517	LV429518	LV432593	LV432594
	connection adapter for plug-in base	-	-	-	LV429306	LV429307	LV432584	LV432585	
Rear connection	short terminal shields	LV429515	LV429516	LV432591	LV432592	2 x LV429515	2 x LV429516	2 x LV432591	2 x LV432592
	short rear connectors	LV429235	LV429235	LV432475	LV432475	LV429235	LV429235	LV432475	LV432475
	long rear connectors	LV429236	LV429236	LV432476	LV432476	LV429236	LV429236	LV432476	LV432476
	connection adapter for plug-in base	-	-	-	-	LV429306	LV429307	LV432584	LV432585

(1) PowerTag NSX is not compatible with plug-in mounting

(2) Metering and signaling features (ammeter...) can be added. Mounted on a ComPacT NSX, it has the same size than a ComPacT Vigi NSX. Refer to the corresponding column.

ComPacT, ComPacT Vigi (ELCB) and VigiComPacT NSX 100/160/250

Vertical mounting

Toggle - Fixed

Designed for PowerTag Energy 250/ 630 A
Circuit breakers

Mounting Vertical fixed

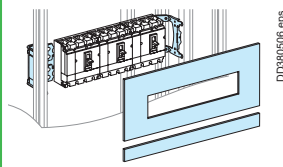
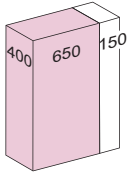

Devices	Toggle			
	NSX/ NSX Vigi (ELCB) 100/160 (1)	Vigi NSX 100/160	NSX/ NSX Vigi (ELCB) 250 (1)	Vigi NSX 250
Number of devices per row	3 x 4P or 4 x 3P	3 x 4P or 4 x 3P	3 x 4P or 4 x 3P	3 x 4P or 4 x 3P
PowerTag 250/ 630 A compatibility	↯	↯	↯	↯
No. of vertical modules	6 or 7	8	7 or 8	9
Mounting plates	LVS03420	LVS03420	LVS03420	LVS03420
Front plates	with cut-out	LVS03243 [5]	LVS03241 [7]	LVS03243 [5]
[No. of vertical modules]	downstream	LVS03801 [1]	LVS03801 [1]	LVS03802 [2]
	downstream with PowerTag 250/ 630 A	LVS03802 [2]	LVS03802 [2]	LVS03803 [3]

Connection Upstream from lateral busbars

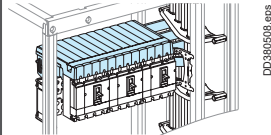

Fixed devices	NSX / NSX Vigi (ELCB) / Vigi NSX100/160/250		
	3P	4P	
Linery FC connection to busbars			
Linery LGY	Linery FC distribution blocks (with connection)	LVS04403	LVS04404
Linery BS, LGYE	Linery FC distribution blocks (without connection) (2)	LVS04407	LVS04408
Other connections to busbars			
Front connection with cable (3)	long terminal shields	LV429517	LV429518
Rear connection with cable	short terminal shields	LV429515	LV429516
	short rear connectors	LV429235	
	long rear connectors	LV429236	
Accessories			
Linery FC tooth-caps	LVS04809		
Divisible blanking plate	LVS03249		
Divisible blanking plate + electronic trip unit	LVS03222		

Connection Downstream distribution

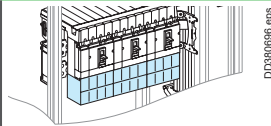

Fixed devices	NSX / NSX Vigi (ELCB) / Vigi NSX 100/160/250		
	3P	4P	
Front connection	long terminal shields	LV429517	LV429518
Rear connection (4)	short terminal shields	LV429515	LV429516
	short rear connectors	LV429235	
	long rear connectors	LV429236	

(1) Metering and signaling features (ammeter...) can be added. Mounted on a ComPacT NSX, it has the same size than a ComPacT Vigi NSX. Refer to the corresponding column.

(2) Flexible bars on Linery LGYE to be made according drawings supplied by Schneider Electric.

(3) For the ComPacT NSX100/250, the number of modules indicated is for supply via a Linery FC distribution block. For supply via cables, two additional modules are required; add an upstream plain front plate (LVS03802).

(4) Size reduced to one module downstream.

ComPacT, ComPacT Vigi (ELCB) and VigiComPacT NSX 100/160/250

Vertical mounting

Toggle - Plug-in

Circuit breakers

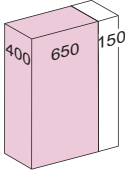
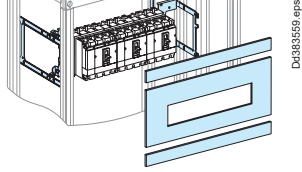
Mounting		Vertical plug-in							
									
Devices		Toggle							
		NSX / NSX Vigi (ELCB) 100/160 (1)		Vigi NSX 100/160		NSX / NSX Vigi (ELCB) 250 (1)		Vigi NSX 250	
Number of devices per row		3 x 4P or 4 x 3P		3 x 4P or 4 x 3P		3 x 4P or 4 x 3P		3 x 4P or 4 x 3P	
No. of vertical modules		9	7	11	9	10	8	12	10
Mounting plates		LVS03421 (2)	LVS03423 (3)	LVS03421 (2)	LVS03423 (3)	LVS03421 (2)	LVS03423 (3)	LVS03421 (2)	LVS03423 (3)
Front plates [No. of vertical modules]	upstream	LVS03801 (1) + LVS03802 (2)	LVS03801 (1)	LVS03801 (1) + LVS03802 (2)	LVS03801 (1)	LVS03801 (1) + LVS03802 (2)	LVS03801 (1)	LVS03801 (1) + LVS03802 (2)	LVS03801 (1)
	with cut-out	LVS03243 (5)	LVS03243 (5)	LVS03241 (7)	LVS03241 (7)	LVS03243 (5)	LVS03243 (5)	LVS03241 (7)	LVS03241 (7)
	downstream	LVS03801 (1)	LVS03801 (1)	LVS03801 (1)	LVS03801 (1)	LVS03802 (2)	LVS03802 (2)	LVS03802 (2)	LVS03802 (2)

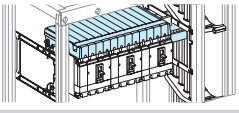
Connection		Upstream from lateral busbars	
			
Plug-in devices		NSX / NSX Vigi (ELCB) / Vigi NSX 100/160/250	
		3P	4P
Linergy FC connection to busbars			
Linergy LGY	Linergy FC distribution blocks (with connection)	LVS04405 (4)	LVS04406 (4)
	Connection adapter for plug-in base	LV429306	LV429307
Linergy BS, LGYE	Linergy FC distribution blocks (without connection) (5)	LVS04407	LVS04408
	Connection adapter for plug-in base	LV429306	LV429307
Connection to lateral busbars with insulated flexible bars			
Front connection	connection	must be made with insulated flexible bars > page G-20.	
	long terminal shields	LV429517	LV429518
	short terminal shields	LV429515	LV429516
Rear connection	connection adapter for plug-in base	LV429306	LV429307
	short terminal shields	2 x LV429515	2 x LV429516
	short rear connectors	LV429235	
	long rear connectors	LV429236	
	connection adapter for plug-in base	LV429306	LV429307
Accessories			
Linergy FC tooth-caps		LVS04809	
Divisible blanking plate		LVS03249	
Divisible blanking plate + electronic trip unit		LVS03222	

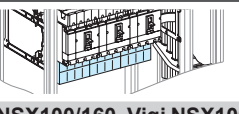
Connection		Downstream distribution	
			
Plug-in devices		NSX100/160, Vigi NSX100/160/250	
		3P	4P
Front connection	connection adapter for plug-in base	LV429306	LV429307
	short terminal shields on device	LV429515	LV429516
	long terminal shields on plug-in base	LV429517	LV429518
Rear connection (6)	short terminal shields	2 x LV429515	2 x LV429516
	short rear connectors	LV429235	
	long rear connectors	LV429236	
	connection adapter for plug-in base	LV429306	LV429307

(1) Metering and signaling features (ammeter...) can be added. Mounted on a ComPacT NSX, it has the same size than a ComPacT Vigi NSX. Refer to the corresponding column.

(2) Not compatible with Linergy FC distribution block.

(3) Compatible with Linergy FC distribution block.

(4) Catalog number LVS04924 is recommended when installing those references.

(5) Flexible bars on Linergy LGYE to be made according drawings supplied by Schneider Electric.

(6) Size reduced to one module downstream.

ComPacT, ComPacT Vigi (ELCB) and VigiComPacT NSX 100/160/250

Vertical mounting

Rotary handle, motor mechanism - Fixed

Designed for PowerTag Energy 250/ 630 A
Circuit breakers



Mounting		Vertical fixed			
Devices		Rotary handle, motor mechanism			
		NSX / NSX Vigi (ELCB) 100/160 (1)	Vigi NSX 100/160	NSX / NSX Vigi (ELCB) 250 (1)	Vigi NSX 250
Number of devices per row		3 x 4P or 4 x 3P	3 x 4P or 4 x 3P	3 x 4P or 4 x 3P	3 x 4P or 4 x 3P
PowerTag 250/ 630 A compatibility		↯)	↯)	↯)	↯)
No. of vertical modules (2)		6 or 7	8 or 9	7 or 8	9 or 10
Mounting plates		LVS03422	LVS03422	LVS03422	LVS03422
Front plates [No. of vert. mod.]	with cut-out downstream	LVS03243 [5]	LVS03244 [7]	LVS03243 [5]	LVS03244 [7]
	downstream with PowerTag 250/ 630 A	LVS03801 [1]	LVS03801 [1]	LVS03802 [2]	LVS03802 [2]
		LVS03802 [2]	LVS03802 [2]	LVS03803 [3]	LVS03803 [3]
Collar		-	LV429285	-	LV429285
IP40 front-panel escutcheons		-	LV429316 (3)	-	LV429316 (3)

Connection		Upstream from lateral busbars	
Fixed devices		NSX / NSX Vigi (ELCB) / Vigi NSX100/160/250	
		3P	4P
Linergy FC connection to busbars			
Linergy LGY	Linergy FC distribution blocks (with connection)	LVS04405 (4)	LVS04406 (4)
Linergy BS, LGYE	Linergy FC distribution blocks (without connection) (5)	LVS04407	LVS04408
Accessories			
Linergy FC tooth-caps		LVS04809	
Divisible blanking plate		LVS03249	
Blanking plate fract. + electronic trip unit		LVS03222	

Connection		Downstream distribution	
Fixed devices		NSX / NSX Vigi (ELCB) / Vigi NSX100/160/250	
		3P	4P
Front connection	long terminal shields	LV429517	LV429518
Rear connection (6)	short terminal shields	LV429515	LV429516
	short rear connectors	LV429235	
	long rear connectors	LV429236	

- (1) Metering and signaling features (ammeter...) can be added. Mounted on a ComPacT NSX, it has the same size than a ComPacT Vigi NSX. Refer to the corresponding column.
- (2) For the ComPacT NSX100/250, the number of modules indicated is for supply via a Linergy FC distribution block. For supply via cables, two additional modules are required; add an upstream plain front plate (LVS03802).
- (3) For ammeter, take LV429285 + LV429318 catalog numbers.
- (4) Catalog number LVS04924 is recommended when installing those references.
- (5) Flexible bars on Linergy LGYE to be made according drawings supplied by Schneider Electric.
- (6) Size reduced to one module downstream.





ComPacT, ComPacT Vigi (ELCB) and VigiComPacT NSX 100/160/250

Vertical mounting

Rotary handle, motor mechanism - Plug-in

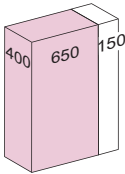
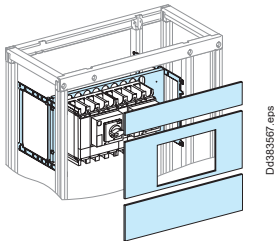
Circuit breakers

Mounting		Vertical plug-in			
					
Devices		Rotary handle, motor mechanism - plug-in			
		NSX / NSX Vigi (ELCB) (1) 100/160	Vigi NSX 100/160	NSX / NSX Vigi (ELCB) (1) 250	Vigi NSX 250
Number of devices per row		3 x 4P or 4 x 3P	3 x 4P or 4 x 3P	3 x 4P or 4 x 3P	3 x 4P or 4 x 3P
No. of vertical modules (2)		7	9	8	10
Mounting plates		LVS03421	LVS03421	LVS03421	LVS03421
Front plates [No. of vertical modules]	upstream	LVS03801 [1]	LVS03801 [1]	LVS03801 [1]	LVS03801 [1]
	with cut-out	LVS03243 [5]	LVS03244 [7]	LVS03243 [5]	LVS03244 [7]
	downstream	LVS03801 [1]	LVS03801 [1]	LVS03802 [2]	LVS03802 [2]
Collar		-	LV429285	-	LV429285
IP40 escutcheons		-	LV429316 (3)	-	LV429316 (3)
Connection		Upstream from lateral busbars			
					
Plug-in devices		NSX / NSX Vigi (ELCB) / Vigi NSX100/160/250			
		3P	4P		
Linerigy FC connection to busbars					
Linerigy LGY	Linerigy FC distribution blocks (with connection)	LVS04405 (4)	LVS04406 (4)		
	Connection adapter for plug-in base	LV429306	LV429307		
Linerigy BS, Linyerigy FC distribution blocks LGYE (without connection) (5)		LVS04407	LVS04408		
Connection adapter for plug-in base		LV429306	LV429307		
Accessories					
Linerigy FC tooth-caps		LVS04809			
Divisible blanking plate		LVS03249			
Blanking plate fract. + electronic trip unit		LVS03222			
Connection		Downstream distribution			
					
Plug-in devices		NSX / NSX Vigi (ELCB) / Vigi NSX100/160/250			
		3P	4P		
Front connection	long terminal shields	LV429517	LV429518		
	short terminal shields	LV429515	LV429516		
	connection adapter for plug-in base	LV429306	LV429307		
Rear connection (6)	short terminal shields	2 x LV429515	2 x LV429516		
	short rear connectors	LV429235			
	long rear connectors	LV429236			
	connection adapter for plug-in base	LV429306	LV429307		

(1) Metering and signaling features (ammeter...) can be added. Mounted on a ComPacT NSX, it has the same size than a ComPacT Vigi NSX. Refer to the corresponding column.

(2) For the ComPacT NSX100/250, the number of modules indicated is for supply via a Linerigy FC distribution block.

For supply via cables, two additional modules are required; add an upstream plain front plate (LVS03802).

(3) For ammeter, take LV429285 + LV429318 catalog numbers.

(4) Catalog number LVS04924 is recommended when installing those references.

(5) Flexible bars on Linerigy LGYE to be made according drawings supplied by Schneider Electric.







(6) Size reduced to one module downstream.

ComPacT and ComPacT Vigi (ELCB) NSXm up to 160

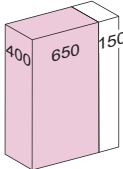
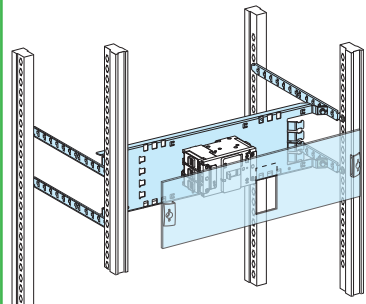
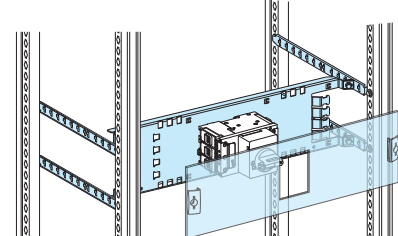
Horizontal mounting

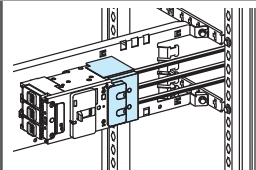
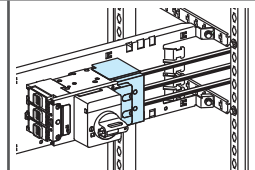
Toggle, rotary handle - Fixed

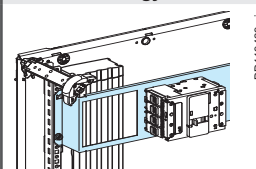
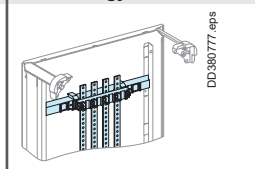
Circuit breakers

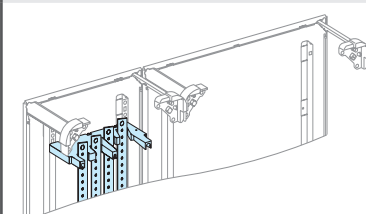
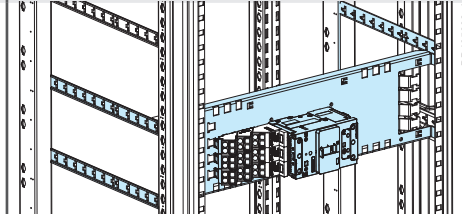
Mounting	Horizontal fixed																																
	 <p style="text-align: right; font-size: small;">DD386146.ai</p>		 <p style="text-align: right; font-size: small;">DD386147.ai</p>																														
	<table border="1" style="width: 100%; border-collapse: collapse;"> <thead> <tr> <th style="background-color: #cccccc;">Devices</th> <th colspan="2" style="background-color: #cccccc;">Toggle</th> <th colspan="2" style="background-color: #cccccc;">Direct rotary handle</th> </tr> <tr> <th style="background-color: #e0f0e0;"></th> <th style="background-color: #e0f0e0;">NSXm</th> <th style="background-color: #e0f0e0;">NSXm Vigi (ELCB)</th> <th colspan="2" style="background-color: #e0f0e0;">NSXm</th> </tr> </thead> <tbody> <tr> <td>Number of devices per row</td> <td>1 x 3P or 4P</td> <td>1 x 3P or 4P</td> <td colspan="2">1 x 3P or 4P</td> </tr> <tr> <td>No. of vertical modules</td> <td>3</td> <td>3</td> <td colspan="2">3</td> </tr> <tr> <td>Mounting plates</td> <td>LVS03409</td> <td>LVS03409</td> <td colspan="2">LVS03409</td> </tr> <tr> <td>Front plates with cut-out <small>[No. of vertical modules]</small></td> <td>LVS03330 [3]</td> <td>LVS03330 [3]</td> <td colspan="2">LVS03331 [3]</td> </tr> </tbody> </table>		Devices	Toggle		Direct rotary handle			NSXm	NSXm Vigi (ELCB)	NSXm		Number of devices per row	1 x 3P or 4P	1 x 3P or 4P	1 x 3P or 4P		No. of vertical modules	3	3	3		Mounting plates	LVS03409	LVS03409	LVS03409		Front plates with cut-out <small>[No. of vertical modules]</small>	LVS03330 [3]	LVS03330 [3]	LVS03331 [3]		
Devices	Toggle		Direct rotary handle																														
	NSXm	NSXm Vigi (ELCB)	NSXm																														
Number of devices per row	1 x 3P or 4P	1 x 3P or 4P	1 x 3P or 4P																														
No. of vertical modules	3	3	3																														
Mounting plates	LVS03409	LVS03409	LVS03409																														
Front plates with cut-out <small>[No. of vertical modules]</small>	LVS03330 [3]	LVS03330 [3]	LVS03331 [3]																														
Connection	Upstream from lateral Linergy LGY, BS, LGYE busbars																																
	 <p style="text-align: right; font-size: small;">DD386150.ai</p>		 <p style="text-align: right; font-size: small;">DD386151.ai</p>																														
	<table border="1" style="width: 100%; border-collapse: collapse;"> <thead> <tr> <th style="background-color: #cccccc;">Devices</th> <th colspan="2" style="background-color: #cccccc;">Toggle</th> <th colspan="2" style="background-color: #cccccc;">Direct rotary handle</th> </tr> <tr> <th style="background-color: #e0f0e0;"></th> <th colspan="2" style="background-color: #e0f0e0;">NSXm, NSXm Vigi (ELCB)</th> <th colspan="2" style="background-color: #e0f0e0;">NSXm</th> </tr> <tr> <th style="background-color: #e0f0e0;"></th> <th style="background-color: #e0f0e0;">3P</th> <th style="background-color: #e0f0e0;">4P</th> <th style="background-color: #e0f0e0;">3P</th> <th style="background-color: #e0f0e0;">4P</th> </tr> </thead> <tbody> <tr> <td>Connection</td> <td colspan="4">Connections must be made</td> </tr> <tr> <td>Long terminal shields</td> <td>LV426912</td> <td>LV426913</td> <td>LV426912</td> <td>LV426913</td> </tr> </tbody> </table>		Devices	Toggle		Direct rotary handle			NSXm, NSXm Vigi (ELCB)		NSXm			3P	4P	3P	4P	Connection	Connections must be made				Long terminal shields	LV426912	LV426913	LV426912	LV426913						
Devices	Toggle		Direct rotary handle																														
	NSXm, NSXm Vigi (ELCB)		NSXm																														
	3P	4P	3P	4P																													
Connection	Connections must be made																																
Long terminal shields	LV426912	LV426913	LV426912	LV426913																													
Connection	Downstream distribution																																
	<p style="background-color: #cccccc; margin: 0; padding: 2px;">Insulated Linergy BW busbars</p>  <p style="text-align: right; font-size: small;">DD119429.ai</p>		<p style="background-color: #cccccc; margin: 0; padding: 2px;">Rear Linergy BS busbars</p>  <p style="text-align: right; font-size: small;">DD380777.eps</p>																														
	<table border="1" style="width: 100%; border-collapse: collapse;"> <tbody> <tr> <td>Busbars</td> <td colspan="3" style="background-color: #e0f0e0;">Linergy BW > page G-14</td> </tr> <tr> <td>Prefabricated connection</td> <td colspan="3" style="background-color: #e0f0e0;">LVS04021, LVS04145, LVS04146, LVS04148</td> </tr> </tbody> </table>		Busbars	Linergy BW > page G-14			Prefabricated connection	LVS04021, LVS04145, LVS04146, LVS04148			<table border="1" style="width: 100%; border-collapse: collapse;"> <tbody> <tr> <td>Busbars</td> <td colspan="3" style="background-color: #e0f0e0;">LVS04191 + copper bars > page G-25</td> </tr> <tr> <td>Prefabricated connection</td> <td colspan="3" style="background-color: #e0f0e0;">LVS04030</td> </tr> </tbody> </table>		Busbars	LVS04191 + copper bars > page G-25			Prefabricated connection	LVS04030															
Busbars	Linergy BW > page G-14																																
Prefabricated connection	LVS04021, LVS04145, LVS04146, LVS04148																																
Busbars	LVS04191 + copper bars > page G-25																																
Prefabricated connection	LVS04030																																
Connection	Downstream distribution																																
	<p style="background-color: #cccccc; margin: 0; padding: 2px;">Linergy BS multi-stage busbars</p>  <p style="text-align: right; font-size: small;">DD380761.eps</p>		<p style="background-color: #cccccc; margin: 0; padding: 2px;">Linergy DP distribution block</p>  <p style="text-align: right; font-size: small;">DD435602.ai</p>																														
	<table border="1" style="width: 100%; border-collapse: collapse;"> <tbody> <tr> <td>Busbars / Distribution block</td> <td colspan="3" style="background-color: #e0f0e0;">LVS04192 + copper bars > pages G-10, G-11</td> </tr> <tr> <td>Prefabricated connection</td> <td colspan="3" style="background-color: #e0f0e0;">Connection must be made</td> </tr> </tbody> </table>		Busbars / Distribution block	LVS04192 + copper bars > pages G-10, G-11			Prefabricated connection	Connection must be made			<table border="1" style="width: 100%; border-collapse: collapse;"> <tbody> <tr> <td>Busbars / Distribution block</td> <td colspan="3" style="background-color: #e0f0e0;">LVS04038, LVS04039 > page G-15</td> </tr> <tr> <td>Prefabricated connection</td> <td colspan="3" style="background-color: #e0f0e0;">Connection must be made</td> </tr> </tbody> </table>		Busbars / Distribution block	LVS04038, LVS04039 > page G-15			Prefabricated connection	Connection must be made															
Busbars / Distribution block	LVS04192 + copper bars > pages G-10, G-11																																
Prefabricated connection	Connection must be made																																
Busbars / Distribution block	LVS04038, LVS04039 > page G-15																																
Prefabricated connection	Connection must be made																																







ComPacT and ComPacT Vigi (ELCB) NSXm up to 160

Vertical mounting

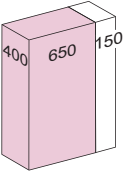
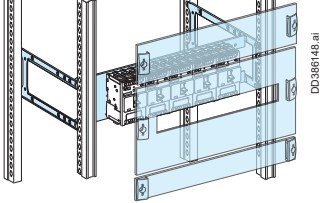
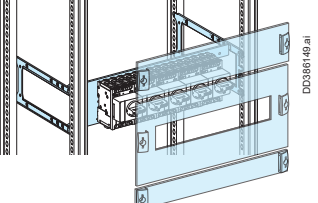
Toggle, rotary handle - Fixed

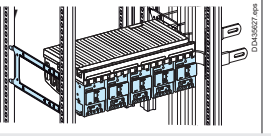
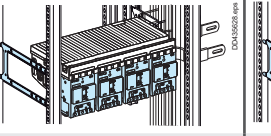
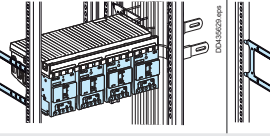
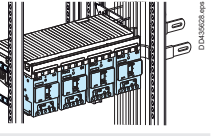
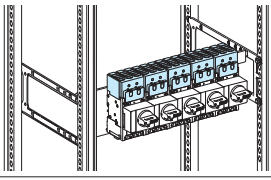
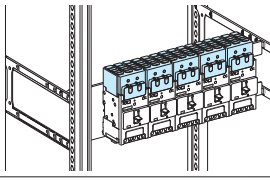
Circuit breakers

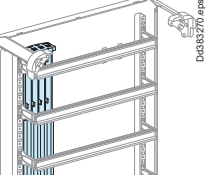
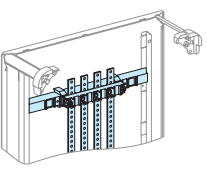
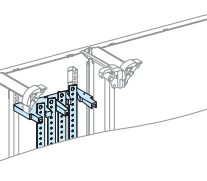
Mounting		Vertical fixed							
									
Devices		Toggle NSXm		NSXm Vigi (ELCB)		Direct rotary handle NSXm			
Number of devices per row		5 x 3P or 4 x 4P		4 x 3P or 4P		5 x 3P or 4 x 4P			
No. of vertical modules(1)		5		5		5			
Mounting plates		LVS03410		LVS03406		LVS03410			
Front plates [No. of vertical modules]		With cut-out LVS03205 [5]		LVS03205 [5]		LVS03226 [5] - 3P LVS03227 [5] - 4P			
		Upstream LVS03802 [2]		LVS03802 [2]		LVS03802 [2]			
		Downstream LVS03801 [1]		LVS03801 [1]		LVS03801 [1]			
Connection		Upstream from lateral Linergy LGY, BS, LGYE busbars							
									
Devices		NSXm, Toggle/Direct rotary handle - with Everlink lug				NSXm Vigi (ELCB), Toggle/Direct rotary handle - with Everlink lug			
Number of poles		3P		4P		3P		4P	
Number of devices per row		5 x 3P		4 x 4P		4 x 3P		4 x 4P	
Linergy FC connection to busbars									
(With connection)	Linergy LGY	LVS04410	LVS04411	LVS04416	LVS04417	LVS04411	LVS04413	LVS04416	LVS04417
	Linergy BS, LGYE	LVS04412	LVS04413	LVS04416	LVS04417	LVS04411	LVS04413	LVS04416	LVS04417
(Without connection)	Linergy BS, LGYE, LGY	LVS04419	LVS04420	LVS04418	LVS04419	LVS04419	LVS04420	LVS04418	LVS04419
Mounting plates		LVS03416		LVS03416		LVS03416		LVS03416	
Front plates [No. of vertical modules]		With cut-out LVS03205 [5]		LVS03205 [5]		LVS03205 [5]		LVS03205 [5]	
		Downstream LVS03802 [2]		LVS03802 [2]		LVS03802 [2]		LVS03802 [2]	
Tooth-caps [No. of tooth-caps]		LVS04810 [12]		LVS04810 [12]		LVS04810 [12]		LVS04810 [12]	
Accessories									
									
Connection		Connections must be made				Connections must be made			
Long terminal shields		LV426912		LV426913		LV426912		LV426913	
Blanking plate		Strip LVS03220		LVS03220		LVS03220		LVS03220	
		Divisible LVS03221		LVS03221		LVS03221		LVS03221	
Connection		Downstream distribution							
		Insulated Linergy BW busbars 		Rear Linergy BS busbars 		Linergy BS Multi-stage busbars in duct 			
Busbars		Linergy BW		LVS04191 + copper bars > page G-9		LVS04192 + copper bars > pages G-10, G-11			
Connection		LVS04030, LVS04145, LVS04146, LVS04147, LVS04148		LVS04145, LVS04146 (centred device)		Must be made			

(1) For ComPacT NSXm up to 160, the number of modules indicated is for supply via a Linergy FC distribution block. For supply via cables, two additional modules are required; add an upstream plain front plate (LVS03802).

ComPacT and ComPacT Vigi (ELCB) NSXm up to 160

Vertical mounting

Toggle, rotary handle - Fixed

Circuit breakers

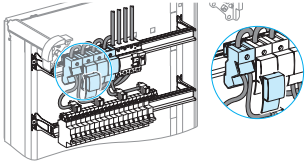
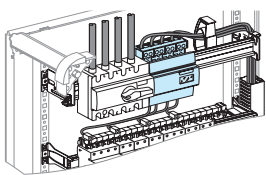
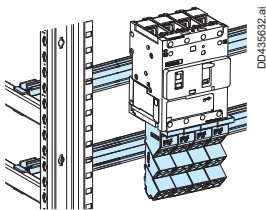
Connection	Downstream distribution		
	Distribution block Linergy DX1P, 160 A	Distribution block Linergy DX 4P, 125 A/160 A	Distribution block Linergy DP 3P/4P
			
Distribution block	LVS04031 > page G-22	LVS04045 > page G-22	LVS04038, LVS04039 > page G-15
Connection	LVS04149	LVS04047	included
Rail			LVS03402 (W650)

ComPacT and ComPacT Vigi (ELCB) NSXm up to 160

Modular devices 160 A

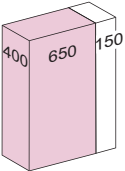
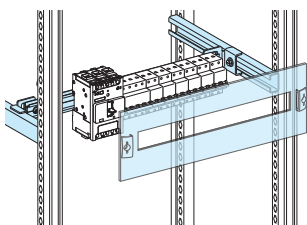
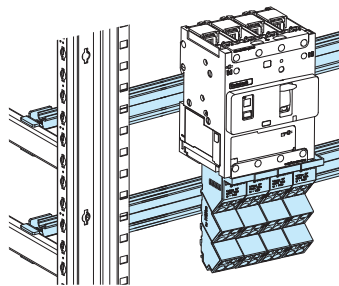
Mounting	Modular rail	
		
Devices	Toggle	NSXm Vigi (ELCB)
	NSXm	
Number of devices per row	5 x 3P or 4 x 4P	4 x 3P or 4P
No. of vertical modules	5 (1)	5 (2)
Rail [48 module of 9mm]	LVS03402 (adjustable) (3)	LVS03402 (adjustable) (3)
Modular front plates	With cut out LVS03205	LVS03205
Blanking plate	Strip LVS03220	LVS03220
	Divisible LVS03221	LVS03221
Connection		
Rail	LVS03402 (W650)	

(1) With Linergy DP, the number of vertical modules will be 7.

(2) With Linergy DP, the number of vertical modules will be 8.

(3) Can be completed by a rail (cat no. LVS04226) + raiser (cat no. LVS04225) to install modular devices.

Note: Width of NSXm 160 circuit breaker:

- NSXm 160 - 3P - 9 modules
- NSXm 160 - 4P - 12 modules
- NSXm VIGI 160 - 3P or 4P - 12 modules

ComPacT and ComPacT Vigi (ELCB) NSXm up to 160

Vertical mounting - W = 400 mm

Toggle, rotary handle - Fixed

Circuit breakers

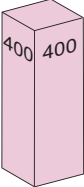
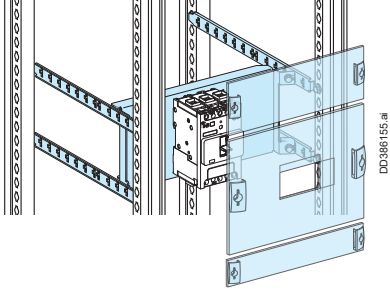
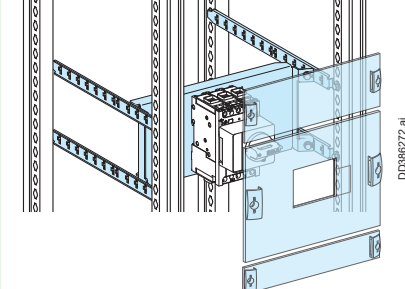
Mounting		Vertical Fixed		
				
Devices		Toggle	NSXm Vigi (ELCB)	Direct rotary handle
		NSXm		NSXm
Number of devices per row		1 x 3P or 4P	1 x 3P or 4P	1 x 3P or 4P
No. of vertical modules		8	8	8
Mounting plates		LVS03405	LVS03405	LVS03405
Front plates	With cut out	LVS03225 [5]	LVS03225 [5]	LVS03225 [5]
[No. of vertical modules]	Upstream	LVS03812 [2]	LVS03812 [2]	LVS03812 [2]
	Downstream	LVS03811 [1]	LVS03811 [1]	LVS03811 [1]

ComPacT INS-INV630b to 1600

ComPacT INS-INV2000-2500

Vertical fixed mounting

Switch-disconnectors

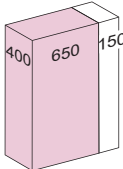
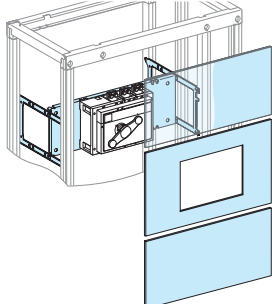
Mounting		Vertical fixed			
					
Devices		Fixed device		INS-INV2000/2500	
		INS-INV630b/1600		INS-INV2000/2500	
		3P	4P	3P	4P
Number of devices per row		1		1	
No. of vertical modules		14		16	
Mounting plates		LVS03501		LVS03501	
Front plates	upstream	LVS03804 [4]		LVS03803 [3]	
[No. of vertical modules]	with cut-out	LVS03713 [6]	LVS03714 [6]	LVS03715 [10]	
	downstream	LVS03804 [4]		LVS03803 [3]	
Characteristics		Depending on the type of front connection, an INS-INV2000-2500 can be mounted in a 400 mm or 600 mm deep enclosure. For rear connection, a 600 mm deep enclosure is required.			

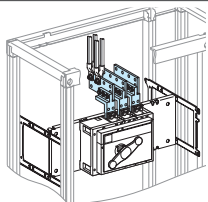
Connection		Upstream on incomer			
					
Fixed device		INS-INV630b/1600		INS-INV2000/2500	
		3P	4P	3P	4P
Vertical connection adapters		31301 (1)	31302 (1)	33975 (1)	33976 (1)
Cable-lug adapters		33644 (1)	33645 (1)	-	-
Connection		-		must be made	
Terminal extension bar support		-		LVS04694	LVS04694

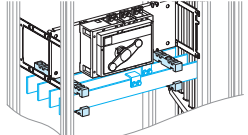
Connection		Downstream distribution via Linergy LGY, LGYE, or BS busbars			
					
Fixed device		INS-INV630b/1600		INS-INV2000/2500	
		3P	4P	3P	4P
Connection LGY		LVS04481	LVS04482	-	
Connection BS, LGYE		must be made (3)		must be made (3)	
Cover for busbars connection		LVS04926 (2)		LVS04926 (2)	
Free support		-		2 x LVS04662	

(1) Vertical connection adapters and cable-lug adapters are not compatible with input voltage ≥ 500 V.

(2) Partitioning of devices must be made.

(3) Connection to be made according to the busbar drawings supplied by Schneider Electric.

Selection of busbars: Linergy LGY > page G-4, Linergy LGYE > page G-5, Linergy BS > page G-6.

ComPacT INS-INV250 to 630

Horizontal / Vertical fixed mounting



Designed for PowerTag Energy 250/ 630 A Switch-disconnectors

Mounting		Horizontal fixed		Vertical fixed		
Devices		Fixed device				
		INS-INV250	INS-INV320/630	INS-INV250	INS-INV320/400	INS-INV500/630
Number of devices per row		1	1	1	2/3	1
PowerTag 250/ 630 A compatibility		⊘	⊘	⊘	⊘	⊘
No. of vertical modules		4	5	7 or 8 (1)		10 or 12
Mounting plates		LVS03412	LVS03452	LVS03420	LVS03461	LVS03461
Front plates upstream		-	-	LVS03801 (1)	-	LVS03801 (1)
[No. of vertical modules] with cut-out		LVS03617 (4)	LVS03658 (5)	LVS03248 (5)	LVS03620 (5)	LVS03274 (10)
downstream		-	-	LVS03801 (1)	-	-
downstream with PowerTag 250/ 630 A		-	-	LVS03802 (2)	LVS03802 (2)	LVS03802 (2)
Connection		Upstream via lateral busbars				
Fixed device		INS-INV250		INS-INV320/630	INS-INV250	INS-INV320/630
		3P	4P			
Linery LGY						
Prefabricated connection		LVS04427 (2)	LVS04428 (2)	must be made (3)	-	must be made (3)
Distribution block Linyer FC		-	-	-	LVS04404	-
Long terminal shields		-	-	LV432594	-	LV432594
Linery BS, LGYE						
Connection		must be made (3)		-		
Linery FC distribution blocks (without connection)		-		LVS04408		must be made
Long terminal shields		LV429518		LV432594		LV432594
Accessories						
Linery FC tooth-caps		-			LVS04809	
Connection		Downstream distribution				
Fixed device		INS-INV250	INS-INV320/630	INS-INV250	INS-INV320/630	
Front connection long terminal shields		LV429518	LV432594	LV429518	LV432594	
Rear connection (4) short terminal shields		LV432516	LV432592	LV432516	LV432592	
short rear connectors		LV429235	LV432475	LV429235	LV432475	
long rear connectors		LV429236	LV432476	LV429236	LV432476	

(1) For the ComPacT INS-INV250, the number of modules indicated is for supply via a Linyer FC distribution block.

For supply via cables, two additional modules are required; add an upstream plain front plate (LVS03802).

(2) Compatible with Linyer LGYE vertical busbar.

(3) To be made according to the busbar drawings supplied by Schneider Electric.

(4) For rear connection, size reduced one module; a plain downstream front plate (LVS03801) is not needed.

Source-changeover

Possible combinations ComPacT NSX100/630, NS630b/1600, MasterPact MTZ1 06/16, MTZ2 08/32

Source-changeover

Manual source-changeover

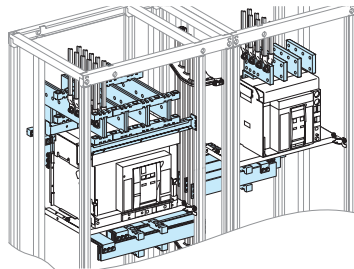

DD383703.eps

Type of device	Type of interlocking							
	Complete assembly	Toggle	Keylock	Rotary handle	On base plate	Cable-type with 2 devices side-by-side (2)	Cable-type with 3 devices side-by-side (2)	Cable-type with 2 devices one above another
INS250 (rating 100 to 250)								
INV100 to INV250 (1)								
INS320 to INS630								
INV320 to INV630 (1)								
NSX100 to NSX250								
NSX400 to NSX630								
NS630b to NS1600								
NT06 to 16								
NW08 to 32								



Remote-operated source-changeover systems - Mechanical interlocking system

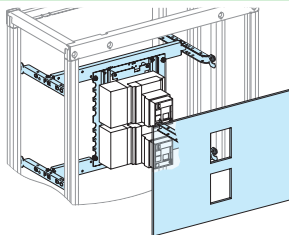

DD383809.eps

Devices "S1"	Combination of ComPacT NSX "S1" and "S2" devices				
	NSX100	NSX160	NSX250	NSX400	NSX630
NSX100 Rating 12.5...100 A					
NSX160 Rating 12.5...160 A					
NSX250 Rating 12.5...250 A					
NSX400 Rating 160...400 A					
NSX630 Rating 250...630 A					

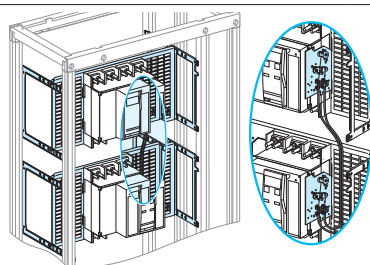

Dd383576.ai

Devices "S1"	Combination of "S1" and "S2" devices, Interlocking via cables		
	NS630b to NS1600	NT06 to 16	NW08 to 40
NS630b to NS1600			
NT06 to 16			
NW08 to 40			



(1) Visible break function.

(2) In 2 or 3 cubicles.

█ Possible combinations.

Manual or remote-operated or automatic source-changeover
 MasterPact MTZ2 08/32, front connection S1 device identical to S2 device

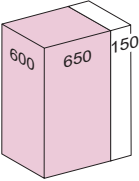
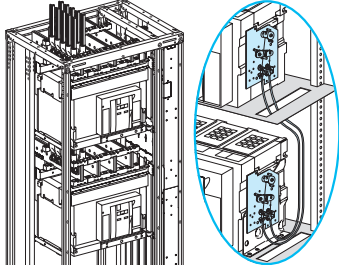
Source-changeover

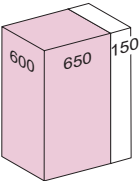
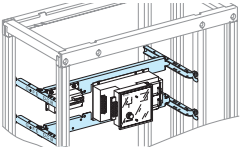
Mounting		Front connection with cables			
					
Devices		Fixed device		Withdrawable device	
Number of devices per row		2		2	
Number of vertical modules		31		34	
Mounting plates		LVS03500		LVS03500	
		S1 device			
Front plates [No. of vertical modules]		NW08/16		NW20/32	
upstream		LVS03804 [4]		LVS03805 [5]	
with cut-out		LVS03711 [9]		LVS03710 [10]	
downstream		LVS03805 [5]		LVS03806 [6]	
		S2 device			
Front plates [No. of vertical modules]		NW08/16		NW20/32	
upstream		-		-	
with cut-out		LVS03711 [9]		LVS03710 [10]	
downstream		LVS03804 [4]		LVS03805 [5]	
Connection					
					
Devices		Fixed device		Withdrawable device	
		S1 device			
Upstream connection		NW08/16		NW20/32	
Connection		Vertical rear connections supplied with the device must be made (1)			
		S2 device			
Downstream connection		NW08/16		NW20/32	
Connection		Vertical rear connections supplied with the device must be made (1)			
Distribution		Linergy LGY, LGYE or BS busbars			
		Selection of busbars: Linergy LGY > page G-4, Linergy LGYE > page G-5, Linergy BS > page G-6.			
		S1 device			
Upstream connection		Front connections supplied with the device			
Connection		must be made (1)			
		S2 device			
Downstream connection		Front connections supplied with the device			
Connection		must be made (1)			
Mounting		Controller outside the device zone			
					
Devices		UA or BA controller			
Number of devices per row		1			
Number of vertical modules		4			
Mounting plates		LVS03417			
Front plates with cut-out [No. of vertical mod.]		LVS03671 [4]			
Characteristics		When a UA, BA or UA150 automatic controller is added together with an ACP mounting plate, the sources can be controlled automatically according to a number of programmed operating modes.			

(1) Connection to be made according to the busbar drawings supplied by Schneider Electric.

Manual or remote-operated or automatic source-changeover
 MasterPact MTZ2 08/32, rear connection S1 device identical to S2 device

Source-changeover

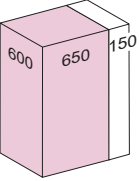
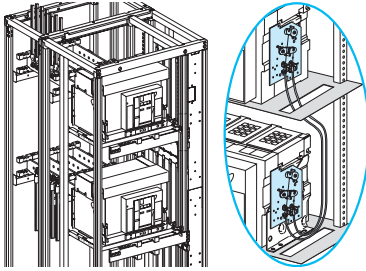
Mounting		Rear connection with cables			
					

Devices		Fixed device		Withdrawable device	
Number of devices per row		2	2	2	2
Number of vertical modules		23	24	25	26
Mounting plates		LVS03500	LVS03500	LVS03500	LVS03500
S1 device					
Front plates [No. of vertical modules]		NW08/16	NW20/32	NW08/16	NW20/32
upstream		-	-	-	-
with cut-out		LVS03711 [9]	LVS03711 [9]	LVS03710 [10]	LVS03710 [10]
downstream		LVS03805 [5]	LVS03806 [6]	LVS03805 [5]	LVS03806 [6]
S2 device					
Front plates [No. of vertical modules]		NW08/16	NW20/32	NW08/16	NW20/32
upstream		-	-	-	-
with cut-out		LVS03711 [9]	LVS03711 [9]	LVS03710 [10]	LVS03710 [10]
downstream		-	-	-	-

Connection		Devices			
		Fixed device		Withdrawable device	
		S1 device		S2 device	
Upstream connection		NW08/16	NW20/32	NW08/16	NW20/32
Connection		Vertical rear connections supplied with the device must be made (1)			
Downstream connection		NW08/16	NW20/32	NW06/10	NW20/32
Connection		Vertical rear connections supplied with the device must be made (1)			

Distribution		Linergy LGY, LGYE or BS busbars			
		Selection of busbars: Linergy LGY > page G-4, Linergy LGYE > page G-5, Linergy BS > page G-6.			
		S1 device		S2 device	
Upstream connection		Front connections supplied with the device must be made (1)			
Downstream connection		Front connections supplied with the device must be made (1)			

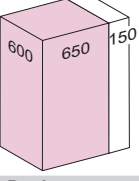
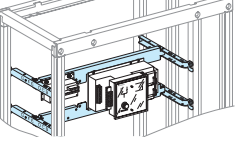
Mounting		Controller outside the device zone			
					
Devices		UA or BA controller			
Number of devices per row		1			
Number of vertical modules		4			
Mounting plates		LVS03417			
Front plates [No. of vertical mod.] with cut-out		LVS03671 [4]			
Characteristics		When a UA, BA or UA150 automatic controller is added together with an ACP mounting plate, the sources can be controlled automatically according to a number of programmed operating modes.			

(1) Connection to be made according to the busbar drawings supplied by Schneider Electric.

Manual or remote-operated or automatic source-changeover
 MasterPact MTZ2 08/32, front connection S1 device different to S2 device

Source-changeover

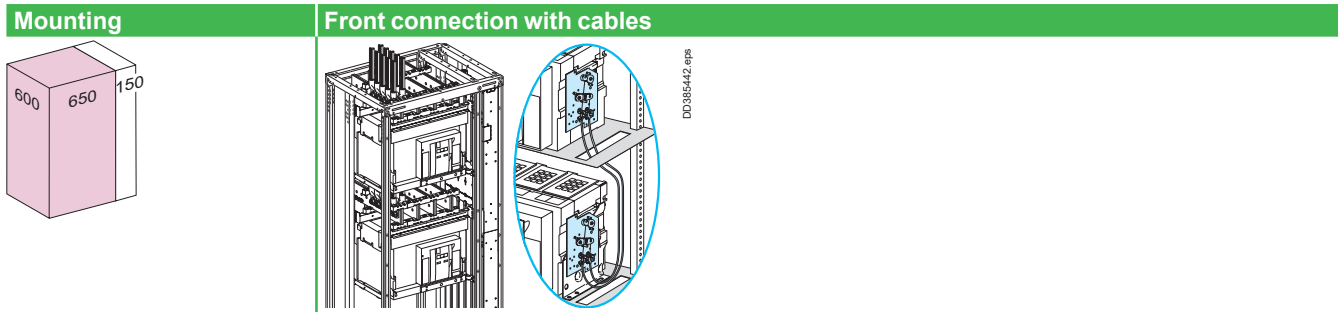

Devices		Fixed device		Withdrawable device	
Number of devices per row		2	2	2	2
Number of vertical modules		33	33	35	35
Mounting plates		LVS03500	LVS03500	LVS03500	LVS03500
S1 device					
Front plates [No. of vertical modules]		NW08/16	NW20/32	NW08/16	NW20/32
upstream	with cut-out	LVS03804 [4]	LVS03805 [5]	LVS03804 [4]	LVS03805 [5]
	downstream	LVS03711 [9]	LVS03711 [9]	LVS03710 [10]	LVS03710 [10]
		LVS03806 [6]	LVS03806 [6]	LVS03806 [6]	LVS03806 [6]
S2 device					
Front plates [No. of vertical modules]		NW20/32	NW08/16	NW20/32	NW08/16
upstream	with cut-out	-	-	-	-
	downstream	LVS03711 [9]	LVS03711 [9]	LVS03710 [10]	LVS03710 [10]
		LVS03805 [5]	LVS03804 [4]	LVS03805 [5]	LVS03804 [4]

Connection



Devices		Fixed device		Withdrawable device	
S1 device					
Upstream connection		NW08/16	NW20/32	NW08/16	NW20/32
Connection		Vertical rear connections supplied with the device must be made (1)			
S2 device					
Downstream connection		NW08/16	NW20/32	NWT06/10	NW20/32
Connection		Vertical rear connections supplied with the device must be made (1)			

Distribution



Distribution		Linergy LGY, LGYE or BS busbars			
		Selection of busbars: Linergy LGY > page G-4, Linergy LGYE > page G-5, Linergy BS > page G-6.			
S1 device					
Upstream connection		Front connections supplied with the device must be made (1)			
S2 device					
Downstream connection		Front connections supplied with the device must be made (1)			

Mounting



Devices		UA or BA controller	
Number of devices per row		1	
Number of vertical modules		4	
Mounting plates		LVS03417	
Front plates [No. of vertical mod.] with cut-out		LVS03671 [4]	
Characteristics		When a UA, BA or UA150 automatic controller is added together with an ACP mounting plate, the sources can be controlled automatically according to a number of programmed operating modes.	

(1) Connection to be made according to the busbar drawings supplied by Schneider Electric.

Manual or remote-operated or automatic source-changeover
MasterPacT MTZ2 08/32, rear connection S1 device different to S2 device

Source-changeover

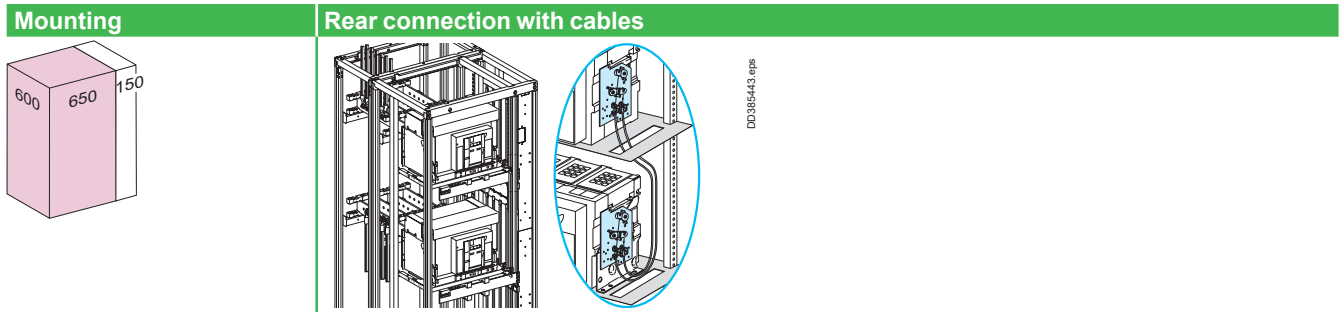

Devices		Fixed device		Withdrawable device	
Number of devices per row		2	2	2	2
Number of vertical modules		24	24	26	26
Mounting plates		LVS03500	LVS03500	LVS03500	LVS03500
S1 device					
Front plates [No. of vertical modules]		MTZ2 08/16	MTZ2 20/32	MTZ2 08/16	MTZ2 20/32
upstream		-	-	-	-
with cut-out		LVS03711 [9]	LVS03711 [9]	LVS03710 [10]	LVS03710 [10]
downstream		LVS03806 [6]	LVS03806 [6]	LVS03806 [6]	LVS03806 [6]
S2 device					
Front plates [No. of vertical modules]		MTZ2 08/16	MTZ2 20/32	MTZ2 08/16	MTZ2 20/32
upstream		-	-	-	-
with cut-out		LVS03711 [9]	LVS03711 [9]	LVS03710 [10]	LVS03710 [10]
downstream		-	-	-	-

Connection		Fixed device		Withdrawable device	
S1 device					
Upstream connection		MTZ2 08/16	MTZ2 20/32	MTZ2 08/16	MTZ2 20/32
Connection		Vertical rear connections supplied with the device must be made (1)			
S2 device					
Downstream connection		MTZ2 08/16	MTZ2 20/32	MTZ2 06/10	MTZ2 20/32
Connection		Vertical rear connections supplied with the device must be made (1)			

Distribution		Linergy LGY, LGYE or BS busbars			
Selection of busbars: Linergy LGY > page G-4, Linergy LGYE > page G-5, Linergy BS > page G-6.					
S1 device					
Upstream connection		Front connections supplied with the device			
Connection		must be made (1)			
S2 device					
Downstream connection		Front connections supplied with the device			
Connection		must be made (1)			

Mounting		Controller outside the device zone	
Devices			
Number of devices per row		1	
Number of vertical modules		4	
Mounting plates		LVS03417	
Front plates [No. of vertical mod.] with cut-out		LVS03671 [4]	
Characteristics		When a UA, BA or UA150 automatic controller is added together with an ACP mounting plate, the sources can be controlled automatically according to a number of programmed operating modes.	

(1) Connection to be made according to the busbar drawings supplied by Schneider Electric.

Manual or remote-operated or automatic source-changeover
 MasterPacT MTZ1 06/16, front connection S1 device identical to S2 device

Source-changeover

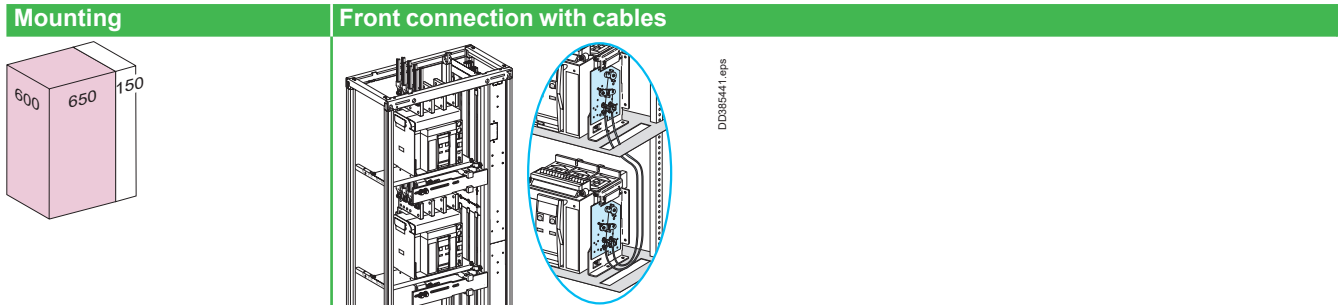

Devices		Fixed device		Withdrawable device	
Number of devices per row		2	2	2	2
Number of vertical modules		24	28	26	30
Mounting plates		LVS03484	LVS03484	LVS03483	LVS03483
S1 device					
		MTZ1 06/10	MTZ1 12/16	MTZ1 06/10	MTZ1 12/16
Front plates [No. of vertical modules]	upstream	LVS03802 [2]	LVS03804 [4]	LVS03802 [2]	LVS03804 [4]
	with cut-out	LVS03692 [7]	LVS03692 [7]	LVS03691 [8]	LVS03691 [8]
	downstream	LVS03803 [3]	LVS03803 [3]	LVS03803 [3]	LVS03803 [3]
S2 device					
		MTZ1 06/10	MTZ1 12/16	MTZ1 06/10	MTZ1 12/16
Front plates [No. of vertical modules]	upstream	LVS03803 [3]	LVS03803 [3]	LVS03803 [3]	LVS03803 [3]
	with cut-out	LVS03692 [7]	LVS03692 [7]	LVS03691 [8]	LVS03691 [8]
	downstream	LVS03802 [2]	LVS03804 [4]	LVS03802 [2]	LVS03804 [4]



Devices		Fixed device				Withdrawable device			
		MTZ1 06/10		MTZ1 12/16		MTZ1 06/10		MTZ1 12/16	
		3P	4P	3P	4P	3P	4P	3P	4P
S1 device		Front connections supplied with the device							
Upstream connection		Front connections supplied with the device							
Vertical connection adapters		33642	33643	33642	33643	33642	33643	33642	33643
S2 device		Front connections supplied with the device							
Downstream connection		Front connections supplied with the device							
Vertical connection adapters		33642	33643	33642	33643	33642	33643	33642	33643

Distribution		Linergy LGY, LGYE or BS busbars							
		Selection of busbars: Linergy LGY > page G-4, Linergy LGYE > page G-5, Linergy BS > page G-6.							
S1 device		Front connections supplied with the device							
Upstream connection		Front connections supplied with the device							
Connection		must be made							
S2 device		Front connections supplied with the device							
Downstream connection		Front connections supplied with the device							
Connection		must be made							

Mounting		Outside the device zone	
Devices		UA or BA controller	
Number of devices per row		1	
Number of vertical modules		4	
Mounting plates		LVS03417	
Front plates [No. of vertical mod.] with cut-out		LVS03671 [4]	
Characteristics		When a UA, BA or UA150 automatic controller is added together with an ACP mounting plate, the sources can be controlled automatically according to a number of programmed operating modes.	

Manual or remote-operated or automatic source-changeover
 MasterPacT MTZ1 6/16, rear connection S1 device identical to S2 device

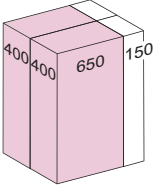
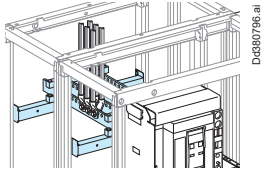
Source-changeover

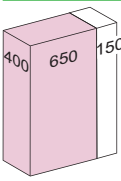
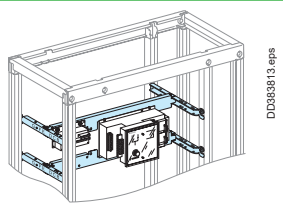

Mounting		Rear connection with cables	
			
Devices		Fixed device	Withdrawable device
Number of devices per row		2	2
Number of vertical modules		22	22
Mounting plates		LVS03484	LVS03483
		S1 device	
		MTZ1 06/16	MTZ1 06/16
Front plates [No. of vertical modules]	upstream	LVS03801 [1]	-
	with cut-out	LVS03692 [7]	LVS03691 [8]
	downstream	LVS03803 [3]	LVS03803 [3]
		S2 device	
		MTZ1 06/16	MTZ1 06/16
Front plates [No. of vertical modules]	upstream	LVS03803 [3]	LVS03803 [3]
	with cut-out	LVS03692 [7]	LVS03691 [8]
	downstream	LVS03801 [1]	-
Connection			
			
Devices		Fixed device	Withdrawable device
		MTZ1 06/16	MTZ1 06/16
		S1 device	
Upstream connection		Vertical rear connections supplied with the device	
Connection		must be made	
		S2 device	
Downstream connection		Vertical rear connections supplied with the device	
Connection		must be made	
Distribution		Linergy LGY, LGYE or BS busbars	
		Selection of busbars: Linergy LGY > page G-4, Linergy LGYE > page G-5, Linergy BS > page G-6.	
		S1 device	
Upstream connection		Front connections supplied with the device	
Connection		must be made	
		S2 device	
Downstream connection		Front connections supplied with the device	
Connection		must be made	
Mounting		Controller outside the device zone	
			
Devices		UA or BA controller	
Number of devices per row		1	
Number of vertical modules		4	
Mounting plates		LVS03417	
Front plates with cut-out [No. of vertical mod.]		LVS03671 [4]	
Characteristics		When a UA, BA or UA150 automatic controller is added together with an ACP mounting plate, the sources can be controlled automatically according to a number of programmed operating modes.	



Manual or remote-operated or automatic source-changeover

MasterPacT MTZ1 06/16, front connection S1 device different to S2 device

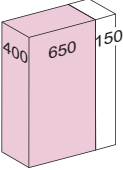
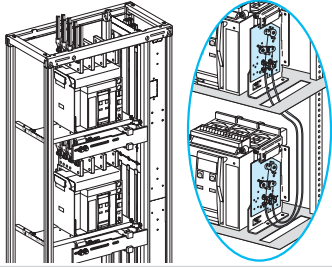

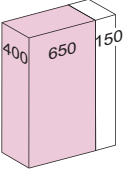
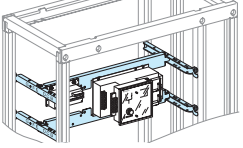
Source-changeover

Mounting		Front connection with cables							
									
Devices		Fixed device				Withdrawable device			
Number of devices per row		2		2		2		2	
Number of vertical modules		26		26		28		28	
Mounting plates		LVS03484		LVS03484		LVS03483		LVS03483	
		S1 device							
		MTZ1 12/16		MTZ1 06/10		MTZ1 12/16		MTZ1 06/10	
Front plates [No. of vertical modules]	upstream	LVS03804 [4]		LVS03802 [2]		LVS03804 [4]		LVS03802 [2]	
	with cut-out	LVS03692 [7]		LVS03692 [7]		LVS03691 [8]		LVS03691 [8]	
	downstream	LVS03803 [3]		LVS03803 [3]		LVS03803 [3]		LVS03803 [3]	
		S2 device							
		MTZ1 06/10		MTZ1 12/16		MTZ1 06/10		MTZ1 12/16	
Front plates [No. of vertical modules]	upstream	LVS03803 [3]		LVS03803 [3]		LVS03803 [3]		LVS03803 [3]	
	with cut-out	LVS03692 [7]		LVS03692 [7]		LVS03691 [8]		LVS03691 [8]	
	downstream	LVS03802 [2]		LVS03804 [4]		LVS03802 [2]		LVS03804 [4]	
Connection									
									
Devices		Fixed device				Withdrawable device			
		MTZ1 06/10		MTZ1 12/16		MTZ1 06/10		MTZ1 12/16	
		3P	4P	3P	4P	3P	4P	3P	4P
S1 device		Upstream connection							
Vertical connection adapters		33642	33643	33642	33643	33642	33643	33642	33643
S2 device		Downstream connection							
Vertical connection adapters		33642	33643	33642	33643	33642	33643	33642	33643
Distribution		Linergy LGY, LGYE or BS busbars							
		Selection of busbars: Linergy LGY > page G-4, Linergy LGYE > page G-5, Linergy BS > page G-6.							
S1 device		Upstream connection							
Connection		must be made							
S2 device		Downstream connection							
Connection		must be made							
Mounting		Controller outside the device zone							
									
Devices		UA or BA controller							
Number of devices per row		1							
Number of vertical modules		4							
Mounting plates		LVS03417							
Front plates [No. of vertical mod.]		with cut-out LVS03671 [4]							
Characteristics		When a UA, BA or UA150 automatic controller is added together with an ACP mounting plate, the sources can be controlled automatically according to a number of programmed operating modes.							

Manual or remote-operated or automatic source-changeover

ComPacT NS630b to 1000

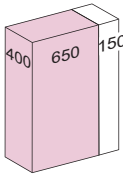
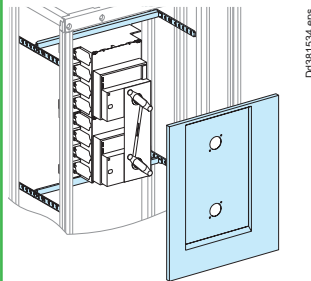

Source-changeover

Mounting		Horizontal	
			
Devices		NS630b/1000	
		3P	4P
Number of devices per row		2	
Number of vertical modules		13	
Mounting plates		LVS03491	
Front plates		upstream -	
[No. of vertical modules]		with cut-out LVS03695 [13]	
		downstream -	
Mechanical interlock		33890	33890
Characteristics		Interlocking of direct rotary handles. The devices are equipped with a direct rotary handle.	
Connection		Downstream distribution	
			
Type of connected devices		ComPacT NS630b/1000	
		3P	4P
Front connection long terminal shields		33628 x 2	33629 x 2

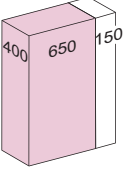
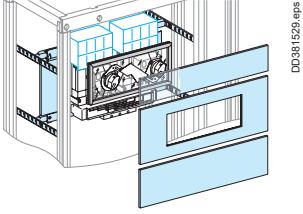
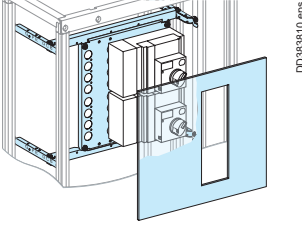

Manual source-changeover
ComPacT NSX100/630

Source-changeover

Mounting		Vertical		Horizontal	
					
Devices		NSX100/250		NSX400/630	
		3P	4P	3P	4P
Number of devices per row		2		2	
Number of vertical modules		10		10	
Mounting plates		LVS03428		LVS03458	
Front plates		LVS03802 [2]		-	
[No. of vertical modules]		with cut-out LVS03245 [5]		LVS03659 [10]	
		downstream LVS03803 [3]		-	
Mechanical interlock		LV429369	LV429369	LV432621	LV432621
Characteristics		Interlocking of rotary handles The devices are equipped with a rotary handle. They are mounted on a dedicated mounting plate.			
Connection		Downstream distribution			
		ComPacT NSX100/250		ComPacT NSX400/630	
		3P	4P	3P	4P
Front conn. long terminal shields		LV429517	LV429518	LV432593	LV432594
for spreader		-	-	LV432595	LV432596
Coupling accessory		LV429358	LV429359	LV432619	LV432620
Rear conn. short terminal shields		LV429515	LV429516	LV432591	LV432592

Remote-operated source-changeover

ComPacT NSX100/630

Source-changeover

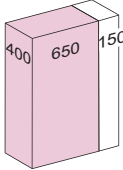
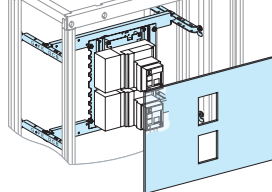
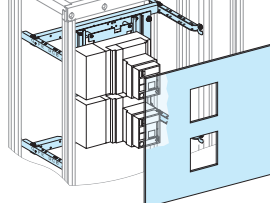
Mounting		Horizontal	
			
			
Devices		NSX100/250	NSX400/630
Number of devices per row		2	2
Number of vertical modules		8	10
Mounting plates		LVS03417 (1)	LVS03457 (2)
Front plates [No. of vertical mod.]		LVS03616 [8] with cut-out	LVS03656 [10]
Characteristics		The devices are equipped with motor mechanisms.	

Connection		Downstream distribution			
					
Type of connected devices		ComPacT NSX100/250		ComPacT NSX400/630	
		3P	4P	3P	4P
Front connection	long terminal shields for spreader	LV429517	LV429518	LV432593	LV432594
Coupling accessory		-	-	LV432595	LV432596
Rear connection	short terminal shields	LV429515	LV429516	LV432591	LV432592

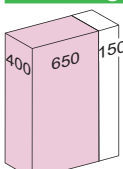
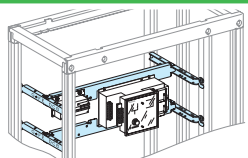
Mounting		Controller	
			
Devices		UA or BA controller	
Number of devices per row		1	
Number of vertical modules		4	
Mounting plates		LVS03417	
Front plates [No. of vertical mod.]		LVS03671 [4] with cut-out	
Characteristics		When a UA, BA or UA150 automatic controller is added together with an ACP mounting plate, the sources can be controlled automatically according to a number of programmed operating modes.	

(1) Order mounting plate + IVE electrical interlocking unit for NSX100/250 (cat. no. 29350 for AC or 29351 for DC version).

(2) Order mounting plate + IVE electrical interlocking unit for NSX400/630 (cat. no. 32610 for AC or 32611 for DC version).

Incoming and busbar connections to be made.

Manual source-changeover

ComPacT INS-INV250 to 630

Front direct rotary handle

Source-changeover

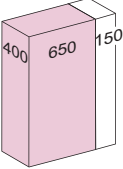
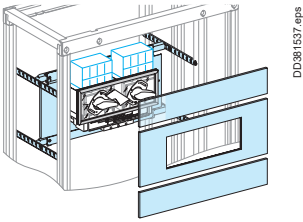
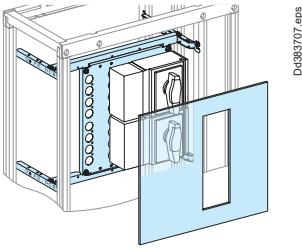
Mounting		Front vertical rotary handle	Front horizontal rotary handle
			
Devices		Mechanical interlocking	
		INS-INV250	INS-INV320/630
Number of devices per row		2	2
Number of vertical modules		9	10
Mounting plates		LVS03428	LVS03458
Front plates [No. of vertical modules]	upstream	LVS03802 [2]	-
	with cut-out	LVS03235 [5]	LVS03659 [10]
	downstream	LVS03802 [2]	-
Mechanical interlock		31073	31074

Distribution					
					
Type of connected devices		ComPacT INS-INV250		ComPacT INS-INV320/630	
		3P	4P	3P	4P
Front conn.	long terminal shields	2 x LV429518	2 x LV429518	-	-
	long terminal shields 45 mm	-	-	2 x LV432594	2 x LV432594
Coupling accessory		LV429359	LV429359	LV432620	LV432620

Manual source-changeover

ComPacT INS-INV250 to 630

Complete assembly device

Source-changeover

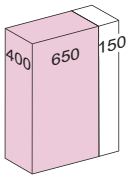
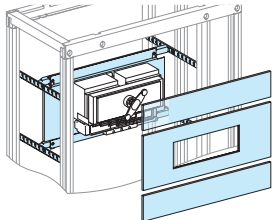
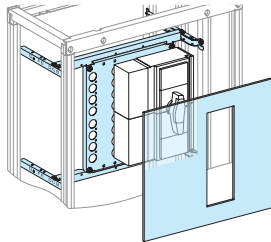
Mounting		Vertical complete assembly	Horizontal complete assembly
			
Devices		Complete source-changeover assembly	
		INS-INV250	INS-INV320/630
Number of devices per row		1	1
Number of vertical modules		9	10
Mounting plates		LVS03428	LVS03458
Front plates [No. of vertical modules]	upstream	LVS03802 [2]	-
	with cut-out	LVS03247 [5]	LVS03661 [10]
	downstream	LVS03802 [2]	-

Distribution					
					
Type of connected devices		ComPacT INS-INV250		ComPacT INS-INV320/630	
		3P	4P	3P	4P
Front conn.	long terminal shields	2 x LV429518	2 x LV429518	-	-
	long terminal shields 45 mm	-	-	2 x LV432594	2 x LV432594
Coupling accessory		LV429359	LV429359	LV432620	LV432620
Complete source-changeover assembly	100 A	31140	31141		
	160 A	31144	31145		
	200 A	31142	31143		
	250 A	31146	31147		
	320 A			31148	31149
	400 A			31150	31151
	500 A			31152	31153
630 A			31154	31155	



TransferPacT Frame 100A Automatic source changeover system W650/800

Changeover system

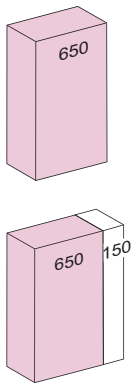
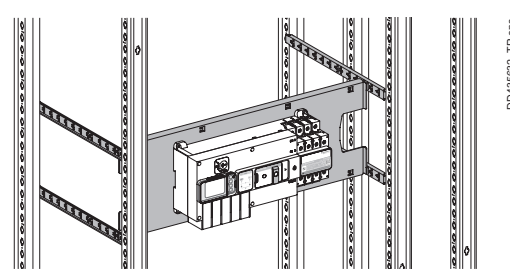
Mounting	Vertical Fixed
	
Devices	TransferPacT Automatic / Active Automatic 32A-100A 2P/3P/4P
No. of devices per row	1
No. of vertical modules	6M
Mounting plate	LVS03424
Front plate with cut-out	LVS03206

Upstream / Downstream Connections

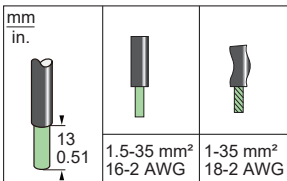
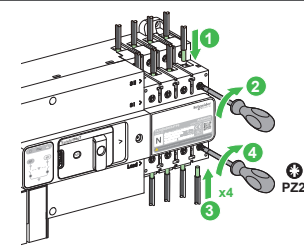
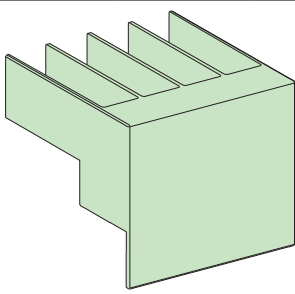
Cable		
Long terminal shields		
	TPSISO30	

Auxiliary

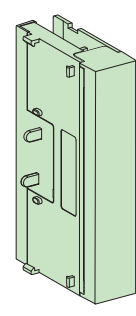
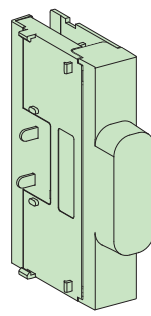
Coupling auxiliary module		
	TPSAUX32	TPSAUX33

TransferPacT Frame 160A Automatic source changeover system W650/800

Changeover system

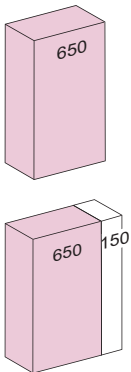
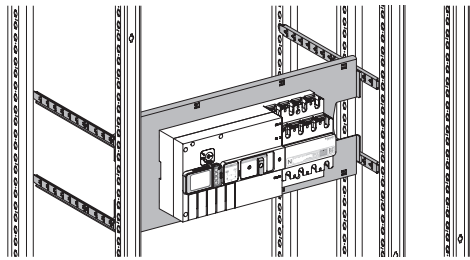
Mounting	Vertical Fixed
	
Devices	TransferPacT Automatic / Active Automatic 80A-160A 3P/4P
No. of devices per row	1
No. of vertical modules	8M
Mounting plate	LVS03425
Front plate with cut-out	LVS03207

Upstream / Downstream Connections

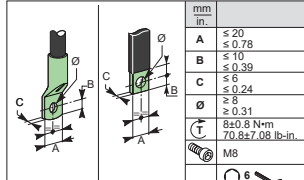
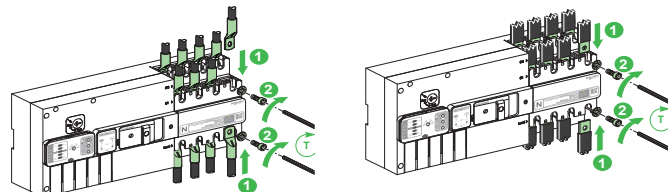
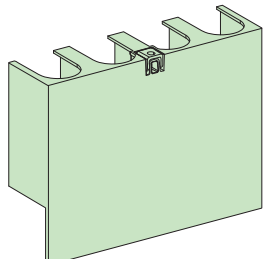
Cable/Busbars		
Long terminal shields	 <p style="text-align: center;">TPSISO31</p>	

Auxiliary

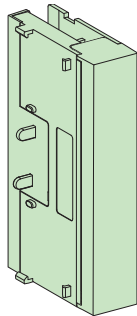
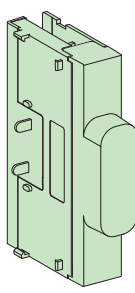
Coupling auxiliary module	 <p style="text-align: center;">TPSAUX32</p>	 <p style="text-align: center;">TPSAUX33</p>
---------------------------	--	--

TransferPacT Frame 250A Automatic source changeover system W650/800

Changeover system

Mounting		Vertical Fixed
Devices	TransferPacT Active Automatic 100A-250A 3P/4P TransferPacT Automatic 200A-250A 3P/4P TransferPacT Remote 160A-250A 3P/4P	
No. of devices per row	1	
No. of vertical modules	13M	
Mounting plate	LVS03429	
Front plate [No. of vertical modules]	upstream	-
	with cut-out	LVS03210 [11]
	downstream	LVS03802 [2]

Upstream / Downstream Connections																																		
Cable		<table border="1"> <thead> <tr> <th colspan="3">CU</th> <th colspan="3">AL</th> </tr> </thead> <tbody> <tr> <td></td> <td></td> <td></td> <td></td> <td></td> <td></td> </tr> <tr> <td>LV429252 LV429256</td> <td>x3 x4</td> <td>x2 x3</td> <td>120 mm²</td> <td>LV429504 LV429505</td> <td>x3 x4</td> <td>x2 x3</td> <td>150 mm²</td> </tr> <tr> <td>LV429253 LV429257</td> <td>x3 x4</td> <td>x2 x3</td> <td>150 mm²</td> <td rowspan="2">LV429506 LV429507</td> <td rowspan="2">x3 x4</td> <td rowspan="2">x2 x3</td> <td rowspan="2">185 mm²</td> </tr> <tr> <td>LV429254 LV429258</td> <td>x3 x4</td> <td>x2 x3</td> <td>185 mm²</td> </tr> </tbody> </table>	CU			AL									LV429252 LV429256	x3 x4	x2 x3	120 mm ²	LV429504 LV429505	x3 x4	x2 x3	150 mm ²	LV429253 LV429257	x3 x4	x2 x3	150 mm ²	LV429506 LV429507	x3 x4	x2 x3	185 mm ²	LV429254 LV429258	x3 x4	x2 x3	185 mm ²
	CU			AL																														
	LV429252 LV429256	x3 x4	x2 x3	120 mm ²	LV429504 LV429505	x3 x4	x2 x3	150 mm ²																										
LV429253 LV429257	x3 x4	x2 x3	150 mm ²	LV429506 LV429507	x3 x4	x2 x3	185 mm ²																											
LV429254 LV429258	x3 x4	x2 x3	185 mm ²																															
Busbar																																		
Linergy	<table border="1"> <thead> <tr> <th>LGY</th> <th>LGYE</th> </tr> </thead> <tbody> <tr> <td></td> <td></td> </tr> </tbody> </table>	LGY	LGYE																															
LGY	LGYE																																	
Connection	Front connection flexible busbar - Must be made (1)																																	

Accessories					
		Available Options			
		Cable Size	TransferPacT		NSX Solution
		1.5 to 35 mm ²	3P: TPSCON47		LV429248
			4P: TPSCON48		LV429249
120 to 240 mm ²	3P: TPSCON49	LV429244			
	4P: TPSCON50	LV429245			
50 to 120 mm ²	3P: TPSCON51	LV429218			
	4P: TPSCON52	LV429219			
			+ LV429518	TPSISO66	

Auxiliary		
TPSAUX43	TPSAUX44	LV434021

(1) Connection to be made according to the busbar drawings supplied by Schneider Electric.

TransferPacT Frame 630A Automatic source changeover system W650/800

Changeover system

Mounting		Vertical Fixed
Devices	TransferPacT Active Automatic 320A-630A 3P/4P TransferPacT Automatic 320-630A 3P/4P TransferPacT Remote 320-630A 3P/4P	
No. of devices per row	1	
No. of vertical modules	13M	
Mounting plate	LVS03429	
Fixed Frame	LVS03371 (1)	
Front plate [No. of vertical modules]	upstream	-
	with cut-out	LVS03211 [11]
	downstream	LVS03802 [2]

Upstream / Downstream Connections

Cable		CU						AL					
		TransferPacT Solution	NSX Solution	Interface Barrier				TransferPacT Solution	NSX Solution	Interface Barrier			
		TPSCON57 TPSCON58	LV432500 LV432501	+ TPSISO65	x3 x4	x2 x3	240 mm ²	TPSCON61 TPSCON62	LV432504 LV432505	+ TPSISO65	x3 x4	x2 x3	240 mm ²
TPSCON59 TPSCON60	LV432502 LV432503	x3 x4	x2 x3		300 mm ²	TPSCON63 TPSCON64	LV432506 LV432507	x3 x4	x2 x3		300 mm ²		

Busbar	

Linergy	LGY	LGYE

Connection Front connection flexible busbar - Must be made (2)

Accessories

		Available Options				
		Cable Size	TransferPacT	NSX Solution	Long Terminal Shield	
		35 to 300 mm ²	3P: TPSCON53	LV432479	+ TPSISO42	
35 to 300 mm ²	4P: TPSCON54	LV432480				

TPSISO67

Auxiliary

Coupling Auxiliary Module	
TPSAUX43	TPSAUX44

(1) Must use fixed frame LVS03371.
 (2) Connection to be made according to the busbar drawings supplied by Schneider Electric.

Fupact ISFL

Vertical / 3P

Determining the busbars

Fusegear

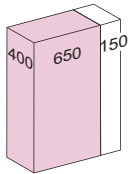
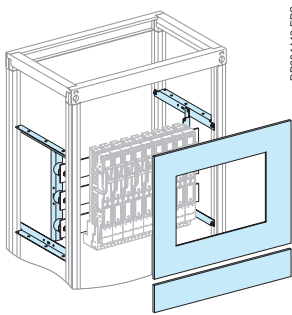
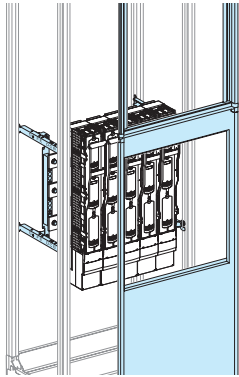
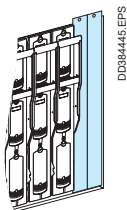
Mounting	Through cut-out front plate	Through a 2/3 cut-out front plate			Accessories
					
Devices	ISFL160	ISFL160	ISFL250/400/630	ISFL 1250	
Number of devices per row	9	10	5	2	-
Number of vertical modules	11	24	24	24	-
Mounting plates	LVS03545 + (1)	LVS03546 + (1)	LVS03546 (1) + (2)	LVS03546 + (2)	-
Length adapter	-	+ 5 x LV480870 (2)	-	-	-
Conversion kit for direct conn.	-	+ 5 x LV480854 (2)	-	-	-
Front plates with cut-out [No. of vertical mod.]	LVS03736 [11]	-	-	-	-
FAV 2/3	-	LVS03735 [24 + 12]	LVS03735 [24 + 12]	LVS03735 [24 + 12]	-
Side frame door cut-out	LV480868 LV480869	LV480868 LV480869	LV480868 LV480869	LV480868 LV480869	-
Blanking plate	LVS03740	LVS03740	LVS03741 (3)	2 x LVS03741	-
Busbars cover	-	-	-	-	LVS04860
Characteristics	<ul style="list-style-type: none"> The fuses are installed on the horizontal bars which are in turn supported by a mounting plate The front plates are secured to the hinged front plate support frame. The front may be covered either by a cover frame or a plain or transparent door. Current transformers can be installed behind ISFL fuse-switch-disconnectors. 				

Connection	Direct
	
Devices	ISFL160/630
Connection	By cables or directly on the busbars with clamp fixing or pressure fixing

Distribution	
	
Devices	ISFL160/630
Downstream connection	With cable

(1) The bars are made by the customer: for choice of bars > pages G-2 to G-13.

(2) Adaptation accessories LV480870 + LV480855 used to:

b install two ISFL160 devices on a mounting plate LVS03546

b mix ISFL devices.

(3) Use 2 blanking plates per device.

Note:

b for ISFL160, by fixing screws only.

b for determining the busbar > page I-60.

Fupact ISFT

Vertical / 3P

Installation on mounting plate or busbars

Determining the busbars

Fusegear/Switch-disconnector

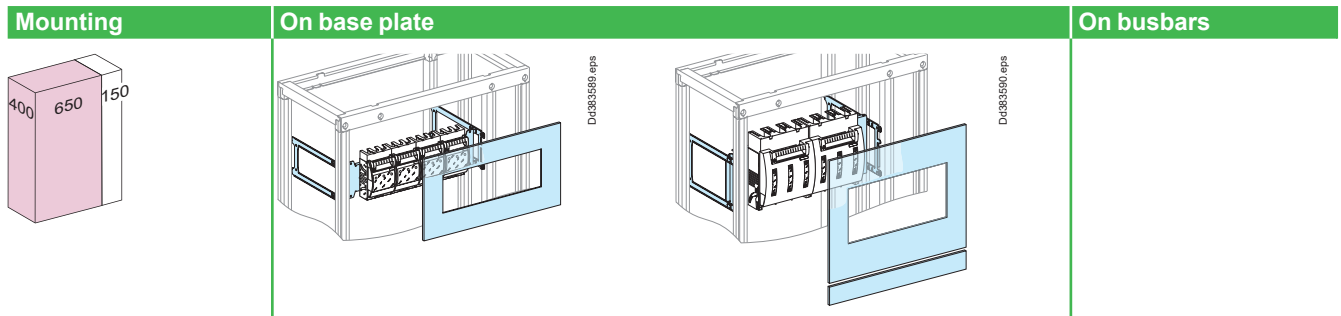

Mounting	On base plate						On busbars	
Devices	ISFT100	ISFT100N	ISFT160	ISFT250	ISFT400	ISFT630	ISFT100N	ISFT160
Number of devices per row	5	8	4	2	2	1	6	4
Number of vertical modules	6	8	6	9	9	10	8	6
Mounting plates	LVS03554	LVS03553	LVS03556	LVS03557	LVS03557	LVS03557	LVS03555	LVS03555
Front plates [No. of vertical mod.]	with cut-out downstream LVS03320 [6]	LVS03325 [8]	LVS03321 [6]	LVS03322 [9]	LVS03323 [9]	LVS03324 [8] LVS03802 [2]	LVS03325 [8]	LVS03321 [6]

Connection	Direct							
Devices	ISFT100	ISFT100N	ISFT160	ISFT250	ISFT400	ISFT630	ISFT100N	ISFT160
Connection	must be made Downstream, with cable or flexible bars							
Long terminal shields	-	LV480756	LV480819	LV480824	LV480827	LV480831	-	LV480819

Distribution			
Linergy FH	for 2 devices	49861	LV480811
	for 3 devices	49862	LV480812
	for 4 devices	49863	LV480813
Set of 3 connectors (25 to 95 mm ²)		49865	LV480818
Set of 3 distribution connectors 3 x 10 mm ²		49860	LV480814

Note: for determining the busbar > page I-60.

Fupact GS

Horizontal / Vertical

Extended rotary handle

Fusegear/Switch-disconnector

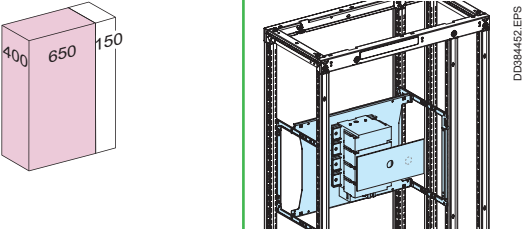
Mounting		Horizontal					
650+150							
Devices		GS32	GS63	GS100 (1)	GS160 (1)	GS250	GS400
		3P or 4P					
Number of devices per row		1					
Number of vertical modules		3	5			7	8
Mounting plates		LVS03559	LVS03560	LVS03560		LVS03564	LVS03566
Front plates with cut-out downstream		LVS03308	LVS03309	LVS03309		LVS03346	LVS03347
Nb of vertical modules		-	-	LVS03801 [1M]		-	-
Upstream connection							
Terminal	3P	-	-	GS1AP33	GS1AP43		
Cover	4P	-	-	GS1AP34	GS1AP44		

Mounting		Vertical					
650 + 150							
Devices		GS32	GS63	GS100 (1)	GS160 (1)	GS250	GS400
		3P or 4P					
Number of devices per row		3	2			1	
Number of vertical modules		3	5			6	
Mounting plates		LVS03559	LVS03563			LVS03565	LVS03567
Front plates with cut-out downstream		LVS03308	LVS03309			LVS03349	LVS03349
Nb of vertical modules		-	-			-	-
Upstream connection							
Terminal	3P	-	-	GS1AP33	GS1AP43		
Cover	4P	-	-	GS1AP34	GS1AP44		

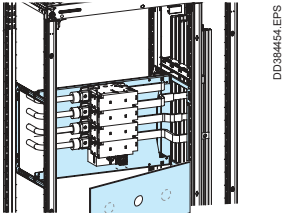
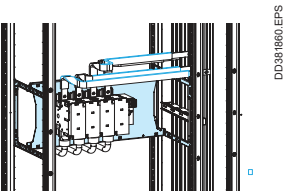
Distribution	Lateral busbars	
		
	Linergy LGYE, Linergy LGY or Linergy BS busbars (2)	
Busbars connection	Must be made	

(1) For DIN fuses only.

(2) Selection of flexible bars for the connection Fupact GS ≤ 400 A: > page I-60.

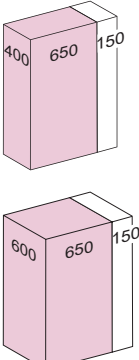
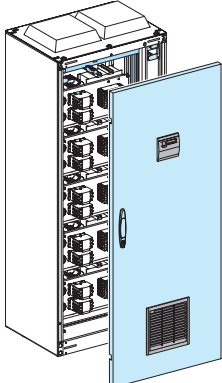
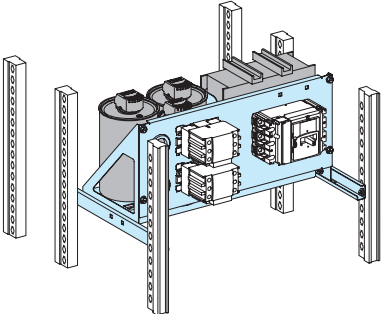
Mounting	Door with cut-outs	Mounting plate
		
Catalog number	LVS03970	LVS03979
Characteristics	Special standard cover panels are used. However, a special IP30 door is used (W650 mm with hinges on left only) that has cut-outs, one for the VarplusLogic power factor controller and another in the bottom for a filter.	The mounting plates are designed for installation of capacitors, contactors and devices protecting against internal faults. The power factor correction modules are installed horizontally in the cubicle. Gasket gland plate NSYTPV is necessary for mounting plate wiring.

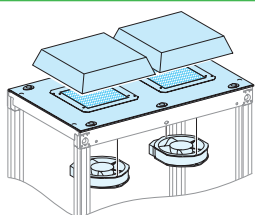
Mounting	Ventilation accessories					
						
Cover panels	Roof with cut-out D = 400 mm D = 600 mm	Fan + top hood	Top hood without fan	Outlet grill	Fan with filter	Spare filter
Catalog number	LVS08478 LVS08678	NSYCVF575M230MB	NSYCAC228RMB	NSYACAG291LPF	NSYCVF850M230PF	NSYCAF228R
Characteristics	A roof with a cut-out ensures natural ventilation of the equipment. It can also be equipped with two fans.	Fan characteristics <ul style="list-style-type: none"> Power: 85 W Input voltage: 230 V Throughput via outlet grill: <ul style="list-style-type: none"> with 1 outlet grill: 350 m³/hr Free with filter: 575 m³/hr Noise level: 64 dB. Top hood characteristics <ul style="list-style-type: none"> Material: steel Finishing parts: painted with epoxy-polyester resin, textured RAL 9003, white IP54 Fixing to the top by means of caged nuts and special screws 	<ul style="list-style-type: none"> Material: steel Finishing parts: painted with epoxy-polyester resin, textured RAL 7035 grey IP54 Fixing to the top by means of caged nuts and special screws 	<ul style="list-style-type: none"> Material: Injected thermoplastic (ASA PC), self-extinguishing according to UL 94 V-0 RAL 9003, white IP54 	<ul style="list-style-type: none"> Power: 150/195 W Input voltage: 207 V... 244 V (230 V) Throughput via outlet grill: <ul style="list-style-type: none"> with 1 outlet grill (m³/h): <ul style="list-style-type: none"> 718 (50 Hz) 568 (60 Hz) Free with filter: <ul style="list-style-type: none"> 838 (50 Hz) 803 (60 Hz) Noise level: 76/75 dB 	For outlet grill or filter IP54, cut-out 228 x 228 mm

Configuration	200 kvar	500 kvar
Door		
Catalog number	LVS03970 + LVS01110	LVS03970 + LVS01110
Designation	W650 door IP30 with cut-out + W150 wicket door	W650 door IP30 with cut-out + W150 wicket door
For front		
Catalog number	NSYCVF850M230PF	NSYACAG291LPF
Designation	Fan with filter	Outlet grill
For rear		
Catalog number	LVS08748	LVS08749 + NSYACAG291LPF
Designation	W800 Rear panel IP55	W800 Rear panel IP55 cut-out + outlet grill
Roof		
Catalog number	LVS08478 or LVS08678	LVS08478 or LVS08678
Designation	Roof with cut-out	Roof with cut-out
On roof		
Catalog number	NSYCAC228RMB x 2	NSYCVF575M230MB x 2
Designation	2 top hood without fan IP54	2 fans + top hood IP54
Mounting plate		
Catalog number	LVS03979	LVS03979
Designation	Mounting plate	Mounting plate

Mounting	On a modular rail					
Devices	Contactor Series D and K ≤ 40 A contactors		Circuit breaker GV2RT- GV2ME- GV2LE		Circuit breaker + contactor GV2 + Series D and K ≤ 40 A contactors	TeSys TeSys modèle U
Number of vertical modules	3		3	5	5	5 4 (1)
Useful length of rail (mm)	432		432		432	432
Modular rail (adjustable)	LVS03402		LVS03401 (2)	LVS03402	LVS03402	LVS03402
Front plates [No. of vertical mod.]	plain	LVS03803 [3]		-	-	LVS03804 [4]
	transparent	-		-	LVS03342 [4]	- ou LVS03342 [4]
	with cut-out downstream	-		LVS03203 [3]	LVS03205 [5]	- LVS03205 [5]
Characteristics	-		Width of devices without lateral auxiliaries: 45 mm.			

Mounting	On a modular rail				On a base plate	
Devices	Soft starters ATS01					LV/LV transformer
	ATS01N103/106FT	ATS01N109/112FT ATS01N206 to 212	ATS01N222 to 232	ATS01N230LY ATS01N244LY ATS01N244Q	ATS01N272LY ATS01N285LY ATS01N272Q ATS01N285Q	ABL6-TS/TD up to 2500 VA ABL6-RT up to 960 W ABL6-RF up to 480 W
Number of vertical modules	4	5	6	5	6	4
Useful length of rail (mm)	432	432	432	432	-	-
Modular rail (adjustable)	LVS03402	LVS03402	LVS03402	LVS03402	-	-
Slotted mounting plates	-	-	-	-	LVS03572	LVS03571
Front plate plain [No. of vertical mod.]	LVS03804 [4]	LVS03805 [5]	LVS03806 [6]	LVS03805 [5]	LVS03806 [6]	LVS03804 [4]
Characteristics	Width of devices (mm)					-
	22.5	45	45	180	180	

(1) Version without communication module, auxiliary contact and reversing module.
(2) Non-adjustable.



Dedicated mounting plate for Motor Control functional units.
5 commercial references from 1 to 6 modules mounting plates are installed in 650 mm wide cubicle.

- Easy installation
- Switchboard upgradeability
- Mounting plate optimal stacking density
- Functional units reliability.

See PrismaSeT MCC catalog DESW049EN.

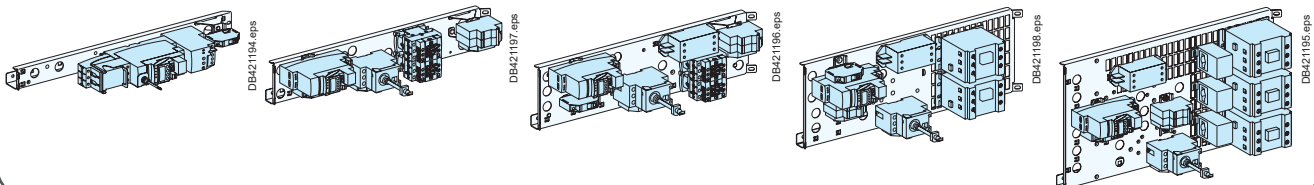

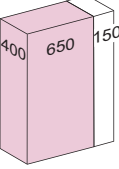
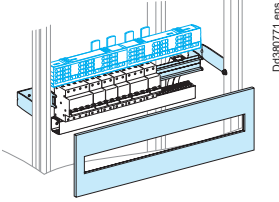
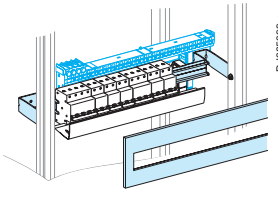
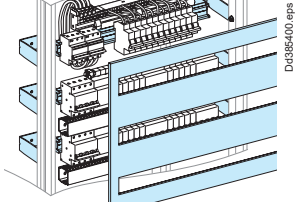
Mounting	Horizontal distances between centres: 200 mm	Horizontal distances between centres: 150 mm	
			
Devices	All modular devices	Modular devices ≤ 40 A	
Rail length (modules of 9 mm)	48	48	48
No. of vertical modules	4 (1)	3	8
Rail (48 modules of 9 mm)	LVS03401	LVS03401	3 x LVS03401
Modular front plates	LVS03204	LVS03203	LVS03223
Blanking strip	LVS03220	LVS03220	LVS03220
plate divisible	LVS03221	LVS03221	LVS03221

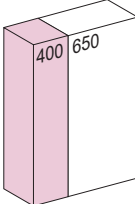
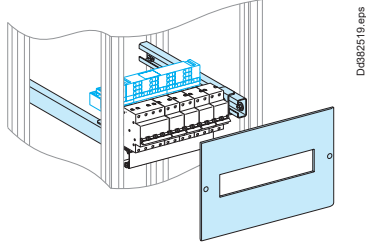
Mounting	Horizontal distances between centres: 200 mm	Horizontal distances between centres: 150 mm	
			
Devices	All modular devices	Modular devices ≤ 40 A	
Rail length (modules of 9 mm)	20	20	20
No. of vertical modules	4	3	3
Rail (20 modules of 9 mm)	LVS03404 (adjustable)	LVS03404 (adjustable)	
Modular front plates	LVS03214 [4]	LVS03213 [3]	
Blanking plate strip	LVS03220	LVS03220	
divisible	LVS03221	LVS03221	

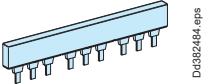
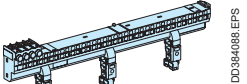
Connection	Linery FH comb busbar	Distribution block Linery FM 63 to 200 A row
		
Type of connected devices	According devices	All type
Comb busbars / distribution blocks	> page G-28	> page G-25

Linery TR Terminal blocks: > page G-40.

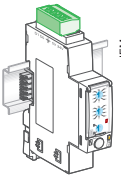
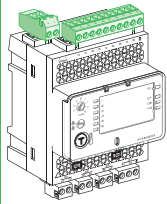
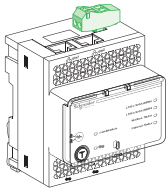
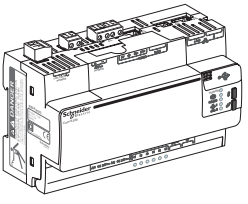
	EnerlinX devices				
	IFM	I/O module	IFE	ComX200	ComX510
					
No. of vertical modules	4				
Rail	LVS03401 / LVS03404				
Modular front plates	LVS03204 / LVS03214				
Characteristics	Installation by clip on a modular rail.				

(1) For a modular row with a 160 A (half row) and 200 A Linery FM distribution block positioned directly below a non-modular mounting-plate (ComPacT, etc.), or at the top of a switchboard, add one additional module (i.e. 4+1) and a plain upstream front plate (LVS03801).



Compatible with PowerTag Energy
Circuit breakers

Mounting	Circuit breakers		Switch-disconnectors	
Devices	NG160, NG160NA Vigi NG160	NG125, NG125NA, Vigi NG125, C120, Vigi C120, iC120, Vigi iC120	ComPacT INS40/160	ComPacT INS-INV100/160 with long terminal shields
No. of vertical modules	5	5	4	5
Rail (48 modules of 9 mm)	LVS03402 (adjustable) (1) + LVS04227	LVS03401	LVS03401	LVS03401
Modular front plates	LVS03205	LVS03205	LVS03204	LVS03205
Blanking plate strip	LVS03220		LVS03220	
divisible	LVS03221		LVS03221	

Mounting	Circuit breakers		Switch-disconnectors	
Devices	NG160, NG160NA, NG125, NSA125/160		INS-INV40/160	INS-INV100/160 with long terminal shields
No. of vertical modules	5		4	5
Rail (20 modules of 9 mm)	LVS03404 (adjustable) (2)		LVS03404 (adjustable)	LVS03404 (adjustable)
Front plates modular	LVS03214 [4]		LVS03214 [4]	LVS03214 [4]
[No. of vertical modules] downstream	LVS03811 [1]		-	LVS03811 [1]
Blanking plate strip	LVS03220		LVS03220	LVS03220
divisible	LVS03221		LVS03221	LVS03221

Connection	Insulated Linergy BW busbars	Rear Linergy BS busbars	Linergy BS multi-stage busbars	Linergy DP 1P, 160 A distribution block	Linergy DX 4P, 160 A distribution block	Linergy DS multi-stage distribution
Type of connected devices	All type	All type	All type	All type	All type	All type
Distribution block / busbars		> page G-9	> page G-11	> page G-14	> page G-22	> page G-26
Connection		must be made	must be made	> page G-14	> page G-22	must be made

(1) Can be completed by a rail + raiser (cat. no. **LVS04227**) to instal modular devices on.
Note: width of NG160 circuit breakers: NG160 3P: 10 modules / NG160 4P: 14 modules
 Vigi NG160 3P: 24 modules / Vigi NG160 4P: 27 modules
 width of NG125 circuit breakers: NG125 3P: 9 modules / NG125 4P: 12 modules
 Vigi NG125 3P ≤ 63 A: fixed sensitivity 18 modules
 adjustable sensitivity 20 modules
 > 63 A: fixed sensitivity 20 modules
 adjustable sensitivity 20 modules
 Vigi NG125 4P ≤ 63 A: fixed sensitivity 21 modules
 adjustable sensitivity 23 modules
 > 63 A: fixed sensitivity 23 modules
 adjustable sensitivity 23 modules
 C120 or iC120 3P: 9 modules / C120 or iC120 4P: 12 modules
 Vigi C120 or iC120 3P: 19 modules / Vigi C120 or iC120 4P: 22 modules
 width of devices: INS-INV40/80: width 10 modules
 INS-INV100/160: width 15 modules.

(2) Can be completed by a rail + raiser (**LVS04227**) to instal modular devices on.
Note: to mix an NSA125/160 circuit breaker with Multi 9 or Acti 9 modular devices, order (with the device) the symmetrical rail + raiser set (**28041**).
 Width of devices: NSA125/160 3P: 10 modules / NSA125/160 4P: 14 modules.

Metering

Single-phase and 3-phase kilowatt-hour meters

Class 1 & 2

Others

Mounting		With 1 mounting plate		
Devices		Meter and connection block Meter 3 Ph + N	Connection block	Meter + connection block
Number of devices per row		2	2	1 + 1
Number of vertical modules		6	6	6
Mounting plates		LVS03508	LVS03508	LVS03508
Front plates [No. of vertical mod.]	transparent or plain	LVS03343 [6] LVS03806 [6]	LVS03343 [6] LVS03806 [6]	LVS03343 [6] LVS03806 [6]

Mounting		With 2 mounting plates	
Devices		Meter and connection block Meter 3 Ph + N	Meter + connection block
Number of devices per row		4	2 + 2
Number of vertical modules		12	12
Mounting plates		2 x LVS03508	2 x LVS03508
Front plates [No. of vertical mod.]	transparent or plain	2 x LVS03343 [6] 2 x LVS03806 [6]	2 x LVS03343 [6] 2 x LVS03806 [6]

Mounting		Behind front plate	
Devices		Meter and connection block Single-phase (Ph + N)	3-phase (3 Ph + N)
Number of devices per row		3	2
Number of vertical modules		6	9
Mounting plates		-	LVS03152
Front plates [No. of vertical mod.]	transparent or plain	LVS03343 [6] LVS03806 [6]	LVS03344 [9] -
Insulating plate		-	-
Adapter		LVS03595	LVS03595
Accessories		M5 spacers for mounting plate > page F-24	

Note: meters can be installed at different levels on the functional uprights of frameworks.

Metering and human-switchboard interface

PowerLogic™ Meters

Others

★ Presentation

PowerLogic™ Meters

Schneider Electric provides these tools via the world's most advanced energy intelligence technology: PowerLogic. The PowerLogic range of meters help manage all energy assets, every second of the day.

PowerLogic PM5000 series



The ideal fit for cost management applications, the PowerLogic™ PM5000 power meter provides:

- > Sub-billing/tenant metering
- > Equipment sub-billing
- > Energy cost allocation
- > Track real-time power conditions
- > Monitor control functions
- > Provide basic power quality values
- > Monitor equipment and network status.

Acti9 iEM2000 & iEM3000 series



The Acti9 iEM2000 & iEM3000 energy meter series offers a cost-attractive, competitive range of DIN rail-mounted energy meters ideal for:

- > Bill checking to verify that you are only charged for the energy you use
- > Sub billing individual tenants for their energy consumption, including WAGES
- > Aggregation of energy consumption, including WAGES, and allocating costs per area, per usage, per shift, or per time within the same facility
- > Basic metering of electrical parameters to better understand the behavior of your electrical distribution system.

Combined with communication systems, like Smart Link, the Acti9 iEM2000 & iEM3000 series makes it easy to integrate electrical distribution measurements into facility management systems. It's the right energy meter at the right price for the right job.

Possible installation

Cat. number	LVS 03904	LVS 03928	LVS 03910	LVS 03911	LVS 03913	LVS 03912	LVS 03914
Front plate frame support (LVS08566)	■	■	■	■	■	■	■
L300/L400 with cut-out (LVS08593, LVS08594)	■	■	■	■	■	-	-

Note: device mounting on door: earthing braid (cat. no. LVS08910) or earthing wire (cat. no. LVS08911) mandatory.

○ Installation in a switchboard

On a metal front plate with cut-outs, H = 150 mm (3 modules)

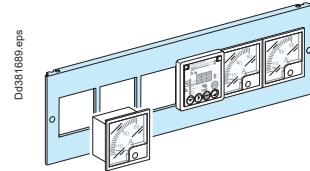

- > Devices are attached directly to the metal front plate.
- > Blanking plates are available to blank off any unused locations.
- > Economical solution.

1

- > In the device zone of enclosures and cubicles, like a front plate

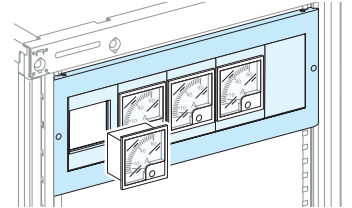

2

- > On a door with cut-outs in a 300 or 400 mm wide cubicle
- > On a inclined visor

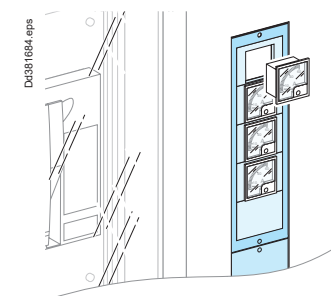











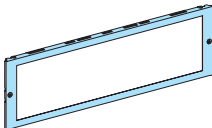





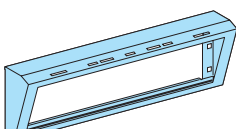





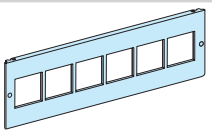

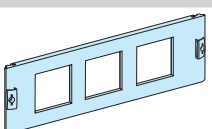

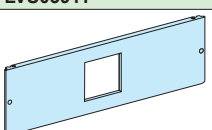
The degree of protection for installed devices is IP30.

Notes:

- To maintain the IP55 degree of protection, the measurement devices must be installed behind a transparent door. If they are installed on a plain door, use the corresponding mounting plates.
- With a power voltage > SELV (12 V), devices on front plates must be mounted with a front plate hinge kit (cat no. LVS08585). The earthing braid must be connected to the front plate frame support (cat no. LVS08566, LVS08564, LVS08560, LVS08562 or else).
- With a power voltage > SELV (12 V) and a supply protection > 16 A, in addition to the preceding rule, the front plate frame support (cat no. LVS08566, LVS08564, LVS08560, LVS08562 or else) must be connected to the cubicle frame, using an earthing braid (cat no. LVS08910 or LVS08911). (standard NF / EN 61439-1 2011 edition).

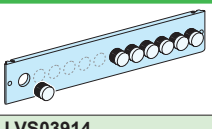
Metering and human-switchboard interface

Others

Number and type of devices per row	Metal front plate with cut-out	No. of vertical mod.	Plastic mounting plates with cut-out	Blanking plate or devices support
W650 Mounting on an interface with plastic mounting plates				
5 x  Vigirex and others devices 72 x 72	 DD385458.eps	3	 DD385465.eps	 DD385466.eps To blank-off or install: - 1 to 4 Ø 16 or 22 mm buttons - 1 device, 45 x 45
4 x  Power Meter and others devices 96 x 96	LVS03904		LVS03902	LVS03900
2 x  For PM200, 200P, PM5 & PM8 series meters		LVS03903	LVS03901	To blank-off or install: - 1 to 4 Ø 16 or 22 mm buttons - 1 device, 45 x 45 - one 72 x 72 device
W650 Mounting on an inclined visor by 30° with plastic mounting plates				
5 x  Vigirex and others devices 72 x 72	 DD385459.eps	3	 DD385465.eps	 DD385466.eps To blank-off or install: - 1 to 4 Ø 16 or 22 mm buttons - 1 device, 45 x 45
4 x  Power Meter and others devices 96 x 96	LVS03928 (1)		LVS03902	LVS03900
2 x  For PM200, 200P, PM5 & PM8 series meters		LVS03903	LVS03901	To blank-off or install: - 1 to 4 Ø 16 or 22 mm buttons - 1 device, 45 x 45 - one 72 x 72 device
W650 Direct mounting on a metal front plate with cut-outs				
72 x 72 device				
6 x  Vigirex and others devices 72 x 72	 DD385460.eps	3	Direct mounting	 DD385468.eps To blank-off or install: - 1 or 2 Ø 22 mm buttons - 1 device, 45 x 45
	LVS03910		-	LVS03907
96 x 96 device				
3x  Power Meter and others devices 96 x 96	 DD118465.eps	3	Direct mounting	 DD385470.eps To blank-off or install: - 1 or 2 Ø 22 mm buttons - 1 device, 45 x 45 - one 72 x 72 device
	LVS03911		-	LVS03908
1 x  Power Meter and others devices 96 x 96	 DD385462.eps	3	Direct mounting	 DD385470.eps To blank-off or install: - 1 or 2 Ø 22 mm buttons - 1 device, 45 x 45 - one 72 x 72 device
	LVS03913		-	LVS03908
144 x 144 device + 72 x 72 devices				
1 x  144 x 144 device	-	4	Direct mounting	 DD385468.eps To blank-off or install: - 1 or 2 Ø 22 mm buttons - 1 device, 45 x 45
+ 4 x  devices 72 x 72	-		-	LVS03907
W650 Pushbuttons and lamps Ø 22 mm				
12 x  Ø 22 mm	 DD385464.eps	2	Direct mounting	
	LVS03914		-	-
W400 Front plate				
1 x  Power Meter and others devices 96 x 96	 DD385960.eps	3	Direct mounting	 DD385470.eps To blank-off or install: - 1 or 2 Ø 22 mm buttons - 1 device, 45 x 45 - one 72 x 72 device
	LVS03923		-	LVS03908

(1) The visor (cat. no. **LVS03928**) can be installed on a plain door with cut-out.
 (2) For PM200, 200P, PM5 & PM 8 series meters, use 2 no. blank off sheets between each meter.

Metering and human-switchboard interface

PowerLogic™ Meters

Vigilohm, Vigirex

Others

Mounting		Powerlogic system			
Devices		FDM121, PM5000 & PM8000 series (2)	PM3000 series, IEM2000 & iEM3000 series	FDM128 (1)	PM5RD, PM89RD96, PM5563RD (3)
		1 device	3 devices		
Number of vertical mod.		3	3	4	4
DIN rail		-	-	LVS03402	LVS03402
Front plates [No. of vert. modules]		transparent		LVS03342 [4]	-
		plain		-	LVS03804 [4]
		with cut-out	LVS03913 [3]	LVS03203 [3]	LVS03804 [4]
Front plate		with cut-out for devices 96 x 96		hole ø 22 mm to be stamped	hole ø 30 mm to be stamped

Mounting		Powerlogic system		
Devices		FDM121, PM5000 series, PM8000 series (2)	FDM128 (1)	PM5RD, PM89RD96, PM5563RD (3)
Number of vertical mod.		3	4	4
DIN rail		-	-	LVS03404
Front plates [No. of vert. modules]		with cut-out	-	-
		plain	LVS03814 [4]	LVS03814 [4]
		-	-	-
Front plate		with cut-out for devices 96 x 96	hole ø 22 mm to be stamped	hole ø 30 mm to be stamped

Mounting		Vigilohm		
Devices		IM400 with 3 XD301 or with 1 or 2 IFL12	IM10, IM10H, IM20, IM20H HV-IM20, HV-IM400, IM9, IM9-OL	IM10 / IM10H IM20 / IM20H
Number of vertical mod.		6	3	3
Modular rail		-	LVS03401	-
Mounting plates		LVS03930	-	-
Front plates with cut-outs		LVS03932	LVS03203	LVS03911
Characteristics		Installation in the device compartment		

Mounting		Vigirex		Acti 9
Devices		RH10/RH21/RH99/RH197M relays	Lamps, pushbuttons	Ammeter, voltmeter
Number of vertical mod.		3	2	3
Modular rail		LVS03401	LVS03401	LVS03401
Front plates with cut-outs		LVS03203	LVS03202	LVS03203
Blanking strip		LVS03220	LVS03220	LVS03220
plate divisible		LVS03221	LVS03221	LVS03221
Characteristics		Installation in the device compartment		

(1) For 72 x 72 mm cases > page E-66.
 (2) Only for flush-mounted versions of PM5000 series and PM8000 series.
 (3) Only for remote-display versions of PM5000 series and PM8000 series.

Cubicles

Contents

Enclosures

Cover panels	F-2
---------------------	------------

Cubicles	
Frameworks	F-5

Dimensions

Cubicles	F-7
-----------------	------------

Enclosures

Cubicles	
IP30/31 cover panels	F-14
IP55 cover panels	F-17
Plinth	F-19
Cubicle handling and Lifting reinforcement kit	F-20

Installation accessories	F-21
---------------------------------	-------------

Front plate accessories	F-22
--------------------------------	-------------

Others

Reserve space	F-23
----------------------	-------------

Fixing accessories	F-24
---------------------------	-------------

Universal adapter	
PrismaSeT G Active adapter - Mounting on a plain backplate	F-25

Others devices	
Mounting on a slotted plate - Mounting on a modular rail	F-26

Cable running	F-27
----------------------	-------------

Connection accessories	
Cable-tie supports, lateral and longitudinal cross-members	F-28

Door handles and locks	F-29
-------------------------------	-------------

Ventilation accessories	
Panel installation	F-30
Roof installation	F-32
Heat	F-33
Regulating	F-34

Switchboard lighting	F-35
-----------------------------	-------------

F

400 mm deep switchboard

For switchboards with front connections.

- front panels

Any of the following can be installed in front of the hinged front plate frame support:

- a transparent door (IP30 or IP55)
- a plain door (IP30 or IP55)
- a fixed cover frame (IP30)
- rear panel = screw-on panel
- side panels = set of two panels
- plain roof
- gland plates (plain or in two parts).

Parts list for switchboard 1

- 1 LVS08406:** framework, W = 650, D = 400, H = 2000
- 2 LVS08566:** front plate frame support, W = 650
- 3 LVS08576:** cover frame, W = 650
- 4 LVS08736:** rear panel, W= 650 (two half panels)
- 5 LVS08751D:** PrismaSeT P Active Green Cover + Wireless Panel Server W650 +lateral panels D400
- 6 LVS08436:** plain roof, W = 650, D = 400
- 7 LVS08486:** plain gland plate, W = 650, D = 400

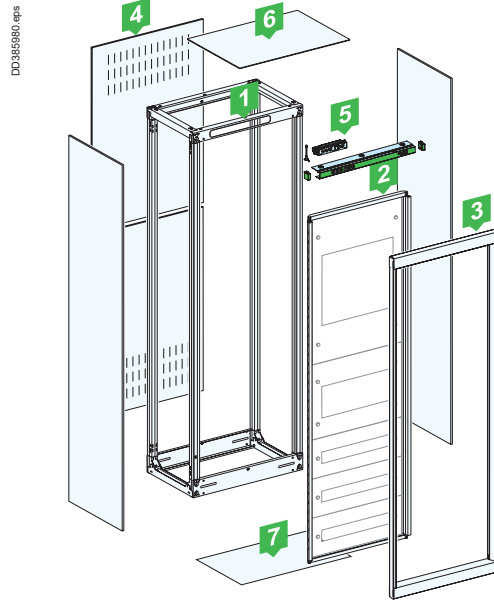

Switchboard 1 - IP30 cubicle with cover frame, W = 650.

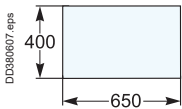

600 mm deep switchboard

For switchboards with front connections.

- front panels

Any of the following can be installed in front of the hinged front plate frame support:

- a transparent door (IP30 or IP55)
- a plain door (IP30 or IP55)
- a fixed cover frame (IP30)
- rear panel = screw-on panel
- side panels = set of two panels
- plain roof
- gland plates (plain or in two parts).

Parts list for switchboard 2

- 1 LVS08603:** framework, W = 300, D = 600, H = 2000
- 2 LVS08607:** framework, W = 800, D = 600, H = 2000
- 3 LVS08606:** framework, W = 650, D = 600, H = 2000
- 4 LVS08566:** front plate frame support, W = 650
- 5 LVS08513:** plain door, W = 300
- 6 LVS08538:** transparent door, W = 800 (supplied with barrier for busbar compartment, W = 150)
- 7 LVS08536:** transparent door, W = 650
- 8 LVS08733:** rear panel, W = 300 (two half panels)
- 9 LVS08738:** rear panel, W = 800 (two half panels)
- 10 LVS08736:** rear panel, W = 650 (two half panels)
- 11 LVS08761D:** PrismaSeT P Active Green Cover + Wireless Panel Server W650 + lateral panels D600
- 12 LVS08633:** plain roof, W = 300, D = 600
- 13 LVS08638:** plain roof, W = 800, D = 600
- 14 LVS08636:** plain roof, W = 650, D = 600
- 15 LVS08683:** plain gland plate, W = 300, D = 600
- 16 LVS08687:** plain gland plate, W = 800, D = 600
- 17 LVS08686:** plain gland plate, W = 650, D = 600.
- 18 LVS08640:** PrismaSeT P Active Green Cover W300
- 19 LVS08643:** PrismaSeT P Active Green Cover W800

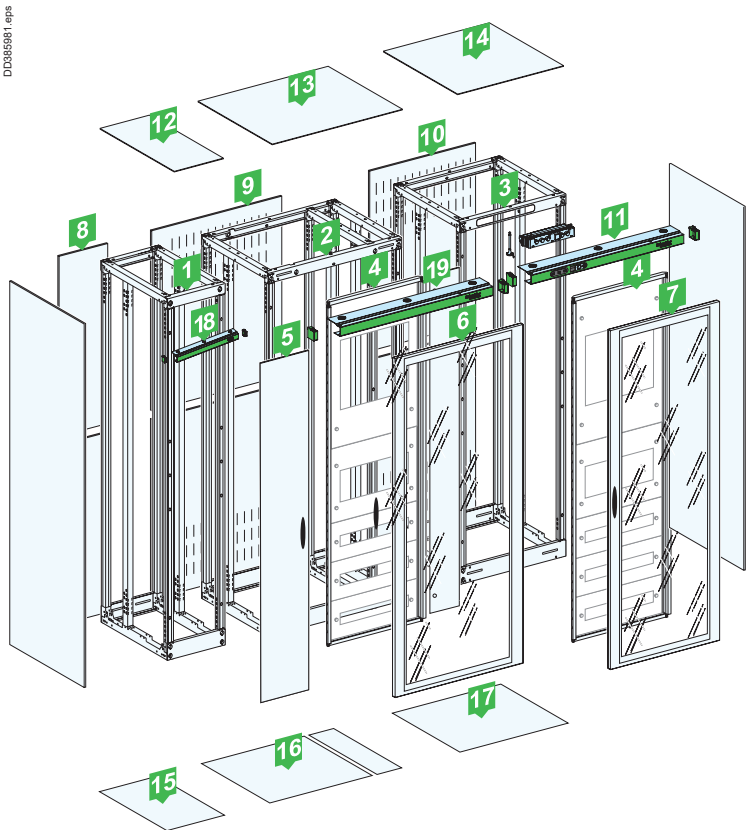

Switchboard 2 - combination of IP30 cubicles with transparent doors.

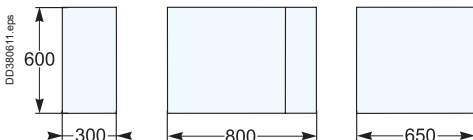

800 mm deep switchboard

Made up of two cubicles back-to-back.
Rear connections are possible.

■ front panels

Any of the following can be installed in front of the hinged front plate frame support:

- a transparent door (IP30 or IP55)
- a plain door (IP30 or IP55)
- a fixed cover frame (IP30)
- rear panel = screw-on panel
- side panels = set of two panels
- plain roof
- gland plates (plain or in two parts).

Parts list for switchboard 3

- 1 LVS08407 x 2**: 2 frameworks, W = 800, D = 400, H = 2000
- 2 LVS08406 x 2**: 2 frameworks, W = 650, D = 400, H = 2000
- 3 LVS08566**: front plate frame support, W = 650
- 4 LVS08578**: fixed cover frame, W = 800 (supplied with a wicket door, W = 150)
- 5 LVS08576**: cover frame, W = 650
- 6 LVS08518**: plain door, W = 800 (supplied with barrier for busbar compartment, W = 150)
- 7 LVS08516**: plain door, W = 650
- 8 LVS08751D**: PrismaSeT P Active Green Cover + Wireless Panel Server W650 +lateral panels D400
- 9 LVS08438 x 2**: plain roofs, W=800, D=400
- 10 LVS08436 x 2**: plain roofs, W=650, D=400
- 11 LVS08487 x 2**: 2 plain gland plate, W = 800, D = 400
- 12 LVS08486 x 2**: 2 plain gland plate, W = 650, D = 400
- 13 LVS08719 x 2**: double depth combination kit
- 14 LVS08753**: PrismaSeT P Active rear access side panels D400
- 15 LVS08643**: PrismaSeT P Active Green Cover W800

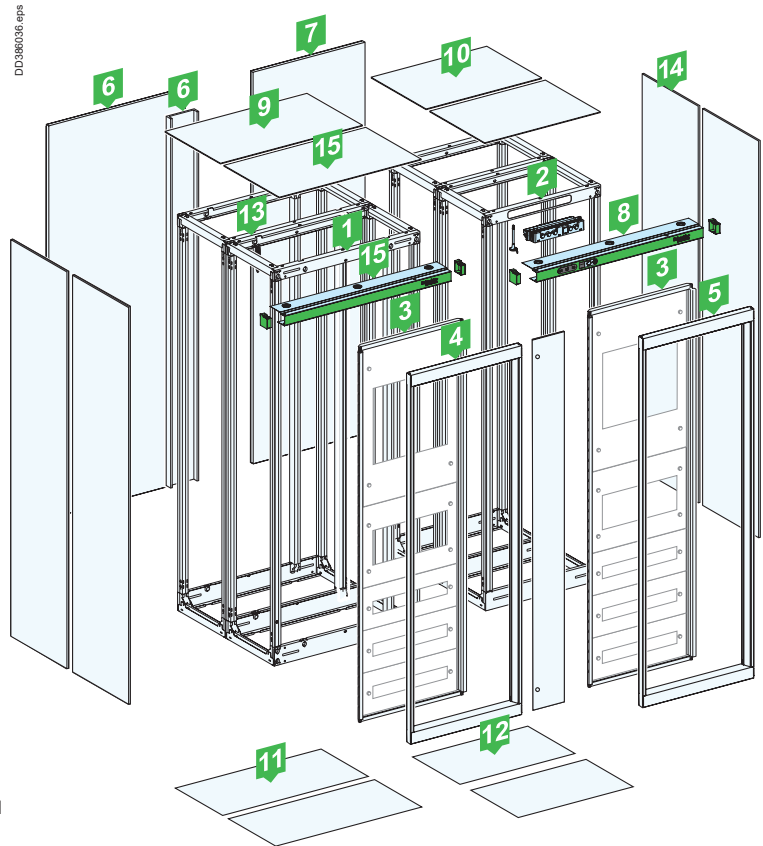
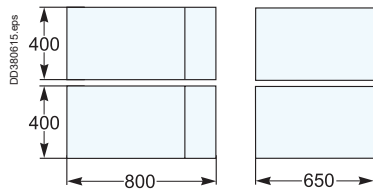

Combination of IP30 cubicles with cover frames.



Cover panels

Enclosures

1000 mm deep switchboard

Made up of two cubicles back-to-back.
Rear connections are possible.

- front panels
- Any of the following can be installed in front of the hinged front plate frame support:
 - a transparent door (IP30 or IP55)
 - a plain door (IP30 or IP55)
 - a fixed cover frame (IP30)
- rear panel = screw-on panel
- side panels = set of two panels
- plain roof
- gland plates (plain or in two parts).

DD380035.eps

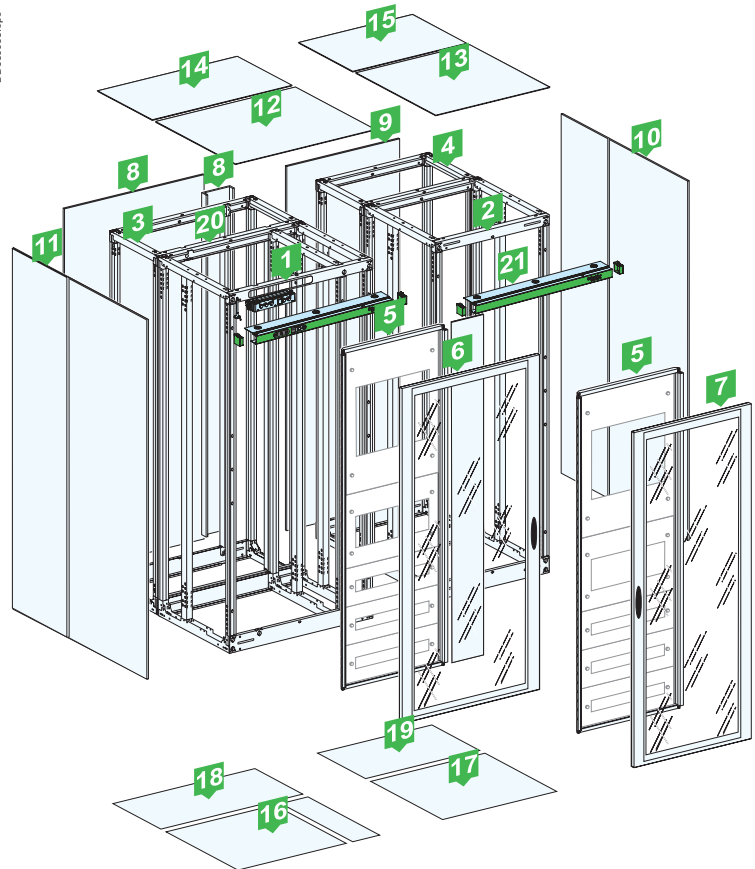

Parts list for switchboard 4

- 1 LVS08607: framework, W = 800, D = 600, H = 2000
- 2 LVS08606: framework, W = 650, D = 600, H = 2000
- 3 LVS08407: framework, W = 800, D = 400, H = 2000
- 4 LVS08406: framework, W = 650, D = 400, H = 2000
- 5 LVS08566: front plate frame support, W = 650
- 6 LVS08538: transparent door, W = 800 (supplied with barrier for busbar compartment, W = 150)
- 7 LVS08536: transparent door, W = 650
- 8 LVS08518: plain door, W = 800 (supplied with barrier for busbar compartment, W = 150)
- 9 LVS08516: plain door, W = 650
- 10 LVS08762D: PrismaSeT P Active Green Cover + Wireless Panel Server W800 + lateral panels D600
- 11 LVS08753: PrismaSeT P Active rear access side panels D400
- 12 LVS08638: plain roof, W = 800, D = 600
- 13 LVS08636: plain roof, W = 650, D = 600
- 14 LVS08438: plain roof, W = 800, D = 400
- 15 LVS08436: plain roof, W = 650, D = 400
- 16 LVS08687: plain gland plate, W = 800, D = 600
- 17 LVS08686: plain gland plate, W = 650, D = 600
- 18 LVS08487: plain gland plate, W = 800, D = 400
- 19 LVS08486: plain gland plate, W = 650, D = 400
- 20 LVS08719 x 2: double depth combination kit
- 21 LVS08642: PrismaSeT P Active Green Cover W650

Combination of cubicles with transparent doors.

Parts list for switchboard IP55



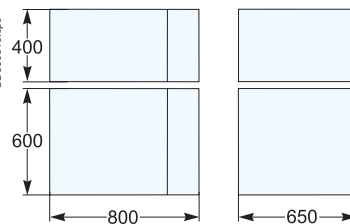

- 1 LVS08607: framework, W = 800, D = 600, H = 2000
- 2 LVS08606: framework, W = 650, D = 600, H = 2000
- 3 LVS08407: framework, W = 800, D = 400, H = 2000
- 4 LVS08406: framework, W = 650, D = 400, H = 2000
- 5 LVS08566: front plate frame support, W = 650
- 6 LVS08548: transparent door, W = 800 (supplied with barrier for busbar compartment, W = 150)
- 7 LVS08546: transparent door, W = 650
- 8 LVS08528: plain door, W = 800 (supplied with barrier for busbar compartment, W = 150)
- 9 LVS08526: plain door, W = 650
- 10 LVS08767D: PrismaSeT P Active Green Cover + Wireless Panel Server W800 + lateral panels D600
- 11 LVS08763: PrismaSeT P Active rear access side panels D400
- 12 LVS08658: plain roof, W = 800, D = 600
- 13 LVS08656: plain roof, W = 650, D = 600
- 14 LVS08458: plain roof, W = 800, D = 400
- 15 LVS08456: plain roof, W = 650, D = 400
- 16 LVS08687: plain gland plate, W = 800, D = 600
- 17 LVS08686: plain gland plate, W = 650, D = 600
- 18 LVS08487: plain gland plate, W = 800, D = 400
- 19 LVS08486: plain gland plate, W = 650, D = 400
- 20 LVS08719 x 2: double depth combination kit
- 21 LVS08717 x 2: IP55 sealing kit for side-by-side combinations
- 22 LVS08642: PrismaSeT P Active Green Cover W650



DD380613.eps

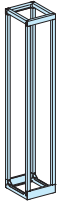
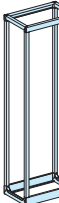
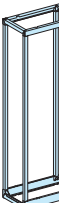

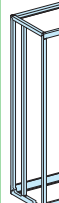
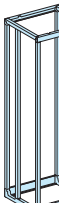
Cubicles Frameworks

Enclosures

Mounting	Frameworks									
										
Width (mm)	300	400	650	800	800 (650 + 150)	300	400	650	800	800 (650 + 150)
	Depth 400 mm					Depth 600 mm				
Cat. no.	LVS08403	LVS08404	LVS08406	LVS08408	LVS08407	LVS08603	LVS08604	LVS08606	LVS08608	LVS08607
Composition	2 frames					3 frames				
	-				+ 2 additional uprights	equipped with intermediate uprights for the mounting plates				
Characteristics	<ul style="list-style-type: none"> 4 cross-pieces. Mounting hardware. Framework combinations <p>Cubicles can be combined side-by-side and back-to-back. Can be equipped with IP30 or IP55 cover panels. Note: for the 800 mm width, the busbar compartment can be on the left or right</p>									

Mounting	Hinged front plate frame support	Fixed front plate frame support
		
Width (mm)	400	650
Cat. no.	LVS08564	LVS08566 (1)
Characteristics	<ul style="list-style-type: none"> Reversible for left or right-hand opening. Secured at two points. <p>Note: can be mounted on 650 mm and 800 mm (650 + 150) wide cubicles. (1) For drawout MasterPact MT22, hinged front plate frame support must open towards left-hand side.</p>	

Partial hinged cover-frame supports

> page E-8.

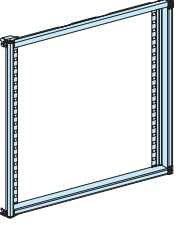
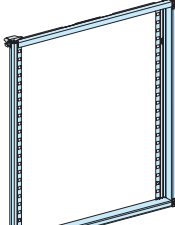
Mounting	Partial hinged cover-frame supports	
		
Width (mm)	650	
	10 modules	12 modules
Cat. no.	LVS08560	LVS08562
Characteristics	<ul style="list-style-type: none"> For drawout MasterPact MT22, hinged front plate frame support must open towards left-hand side. 	<ul style="list-style-type: none"> Use for Fupact ISFL configurations. For drawout MasterPact MT22, when hinged front plate frame support is left-hand opening.

Cubicles Frameworks

Enclosures

Framework combinations		
Type	Side-by-side IP55 sealing kit	Back-to-back Double depth combination kit
Cat. no.	LVS08717	LVS08719
Characteristics	The 650 and 800 mm wide frameworks are supplied with a combination kit comprising six M6 bolts. To maintain the IP55 degree of protection, an optional gasket must be installed between the combined cubicles.	The kit is made up of: <ul style="list-style-type: none"> ■ a set of hardware for the mechanical connections between the cross-pieces ■ six assembly plates to connect the uprights ■ the IP55 sealing kit.

Accessories		
Type	Commodities Fixing screws and nuts	
Cat. no.	LVS08921	LVS08718
Characteristics	Set of 20 screws + wing nuts for framework	Set of 10 screws + combination accessories

Frameworks, D = 400 mm

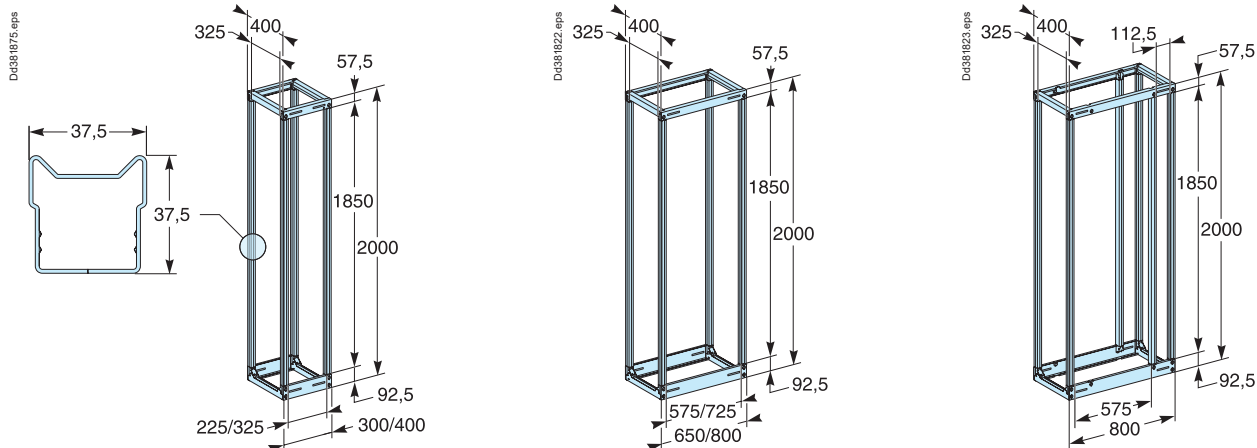

Frameworks, D = 600 mm

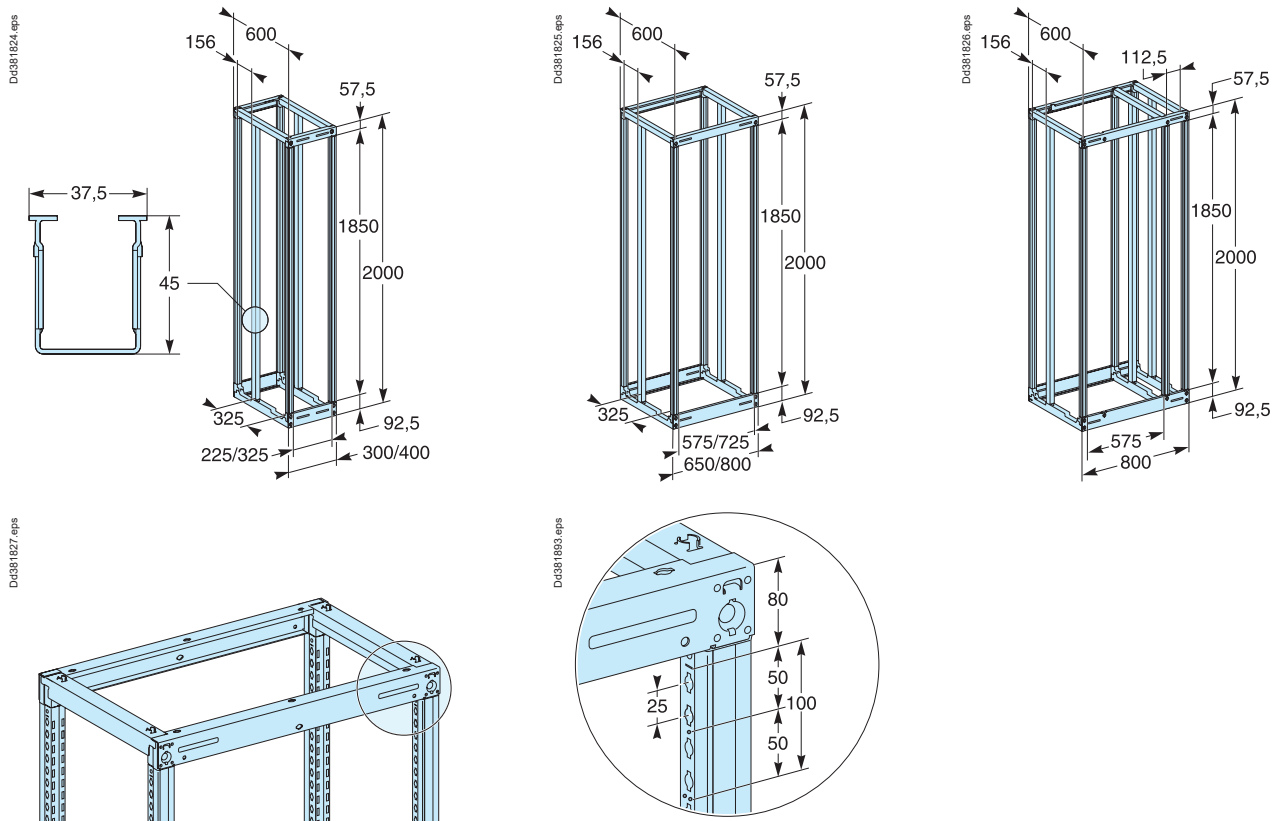

Fixing to floor

Without plinth

With plinth

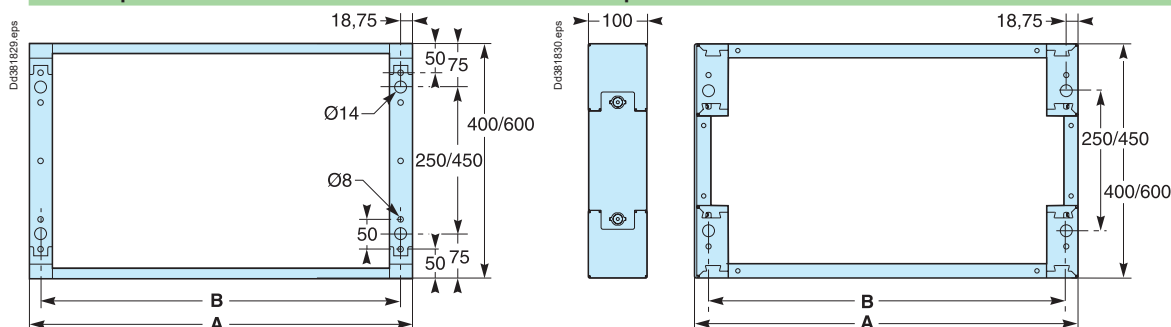

A	B
300	262.5
400	362.5
650	612.5
800	762.5

Dimensions

Cubicle with cover panels

Height

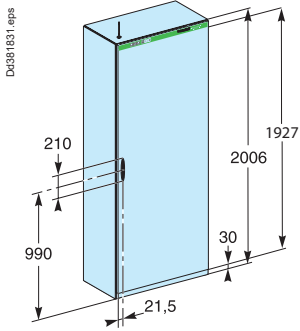

Width

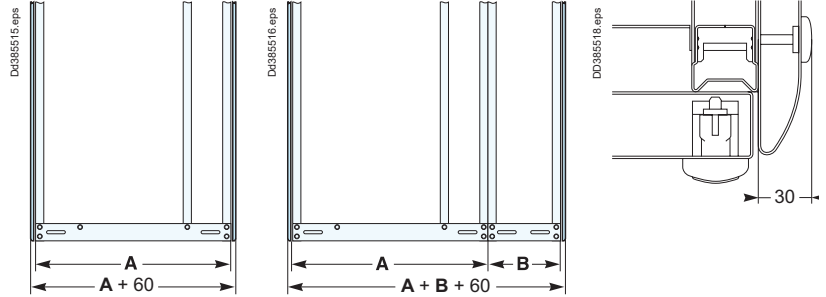

Depth

Door in front and panel in rear

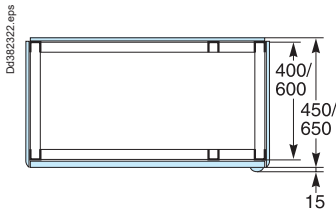

Doors front and rear

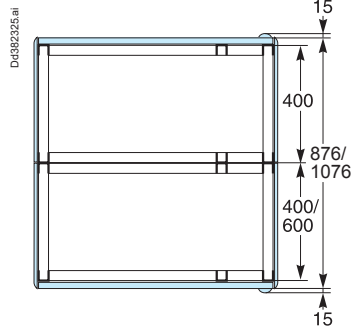
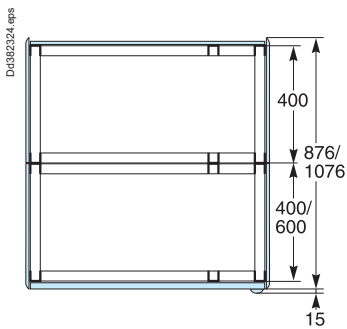
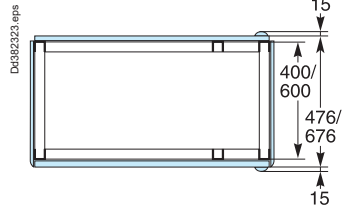

Door

IP30 door

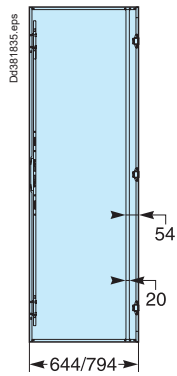
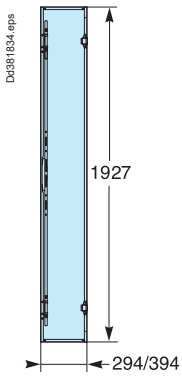

IP55 door

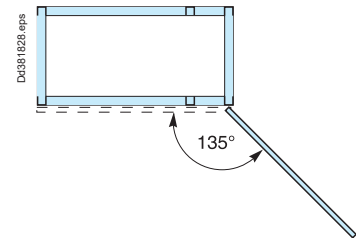
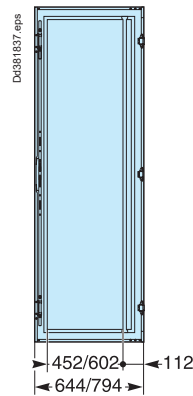
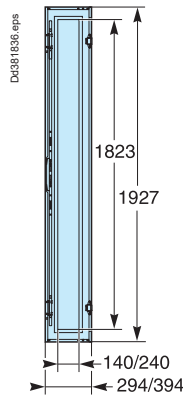

Available space behind door

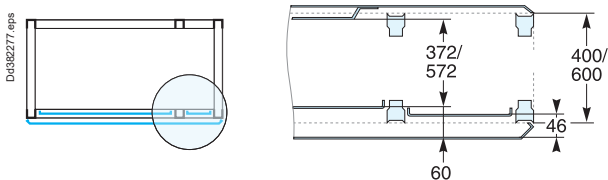

Linery LGYE busbars

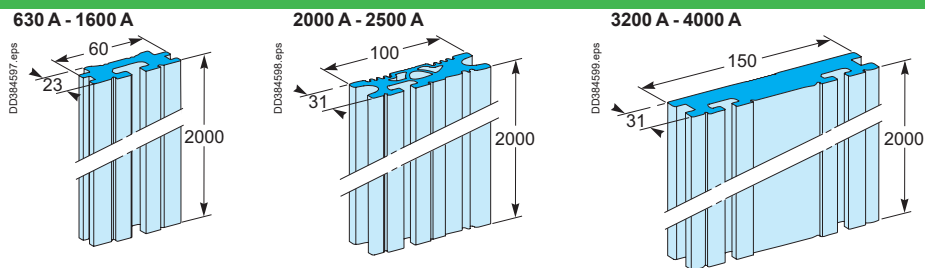

Layout of horizontal Linery LGYE busbars

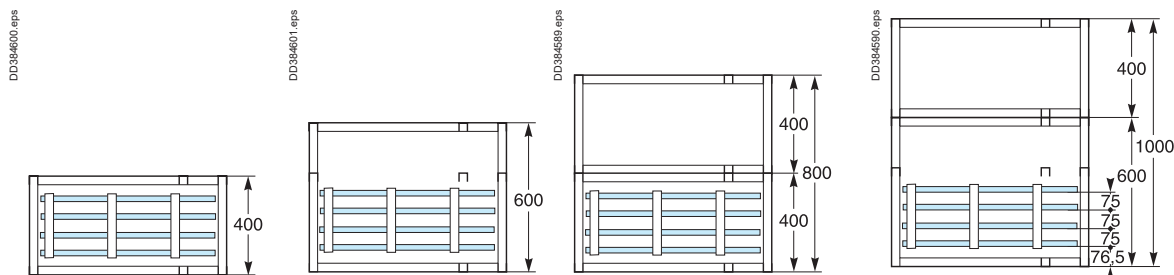

Layout of vertical Linery LGYE busbars

630 A - 1600 A

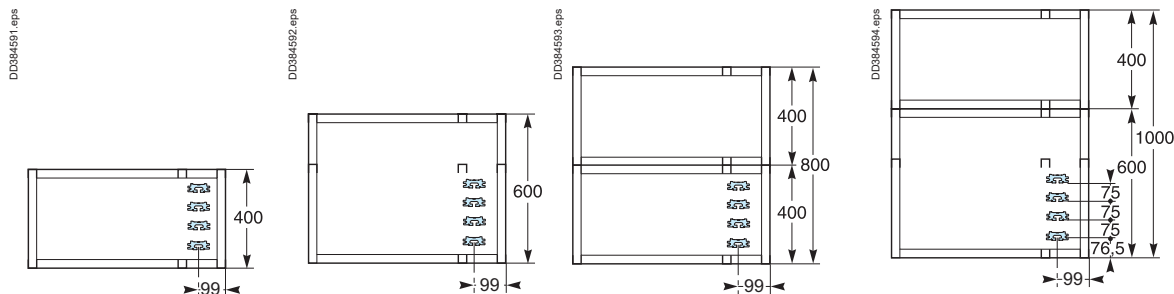

2000 A - 2500 A

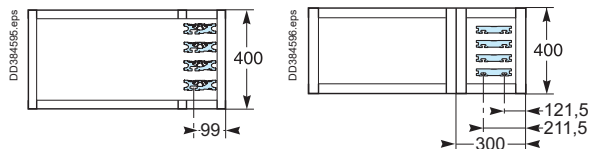

3200 A - 4000 A

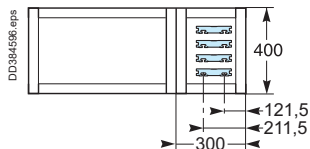

Horizontal Linery BS busbars

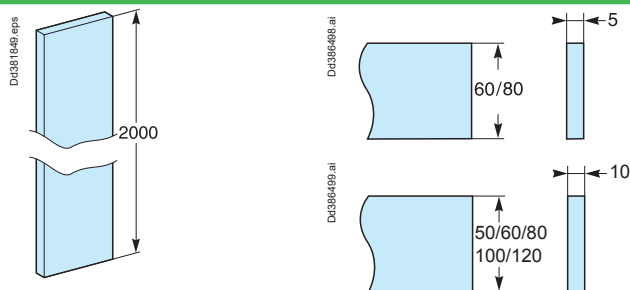

Layout of horizontal Linery BS busbars

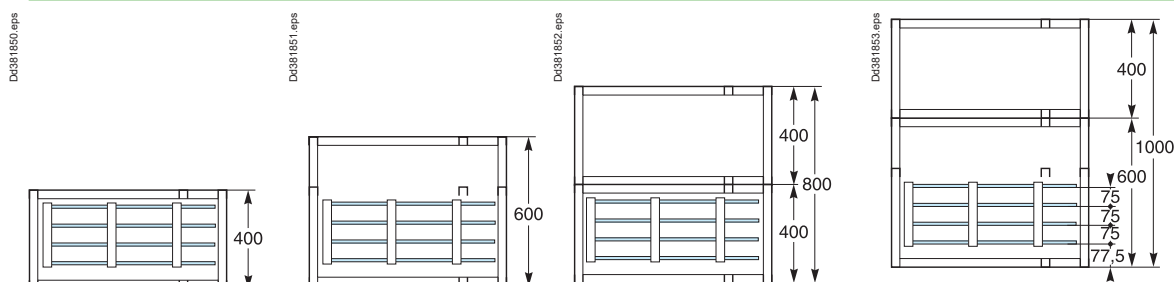

Dimensions

Vertical Linergy LGY busbars

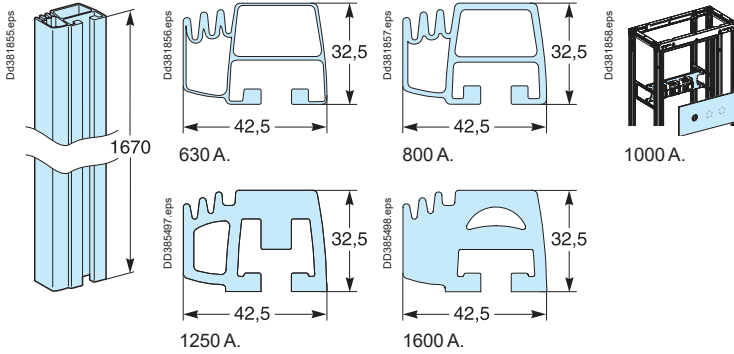

Layout of Linergy LGY busbars

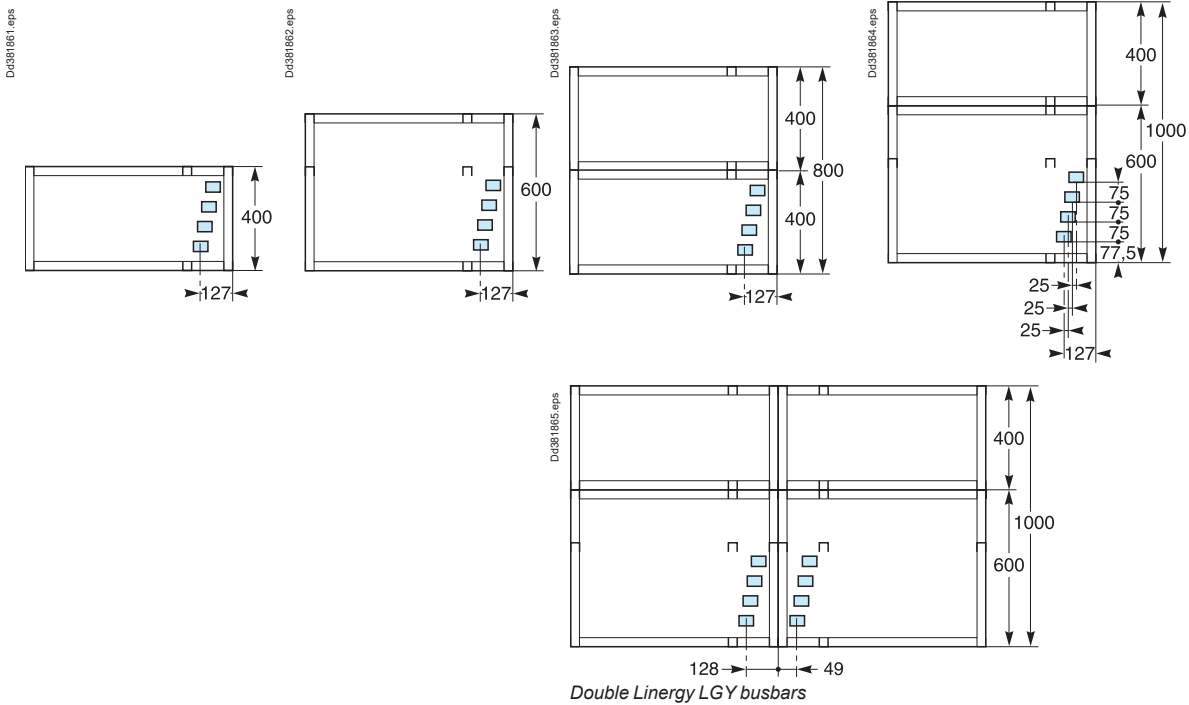

Layout of rear Linergy BS busbars

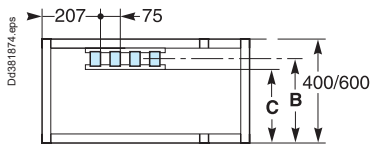

D = 400 mm	B	284
	C	242
D = 600 mm	B	484
	C	442

Vertical Linergy BS busbars

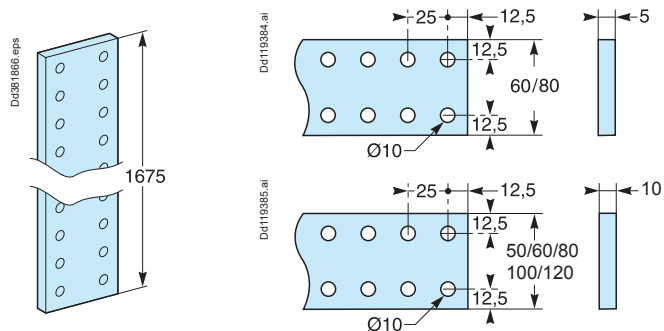

Layout of lateral Linergy BS busbars

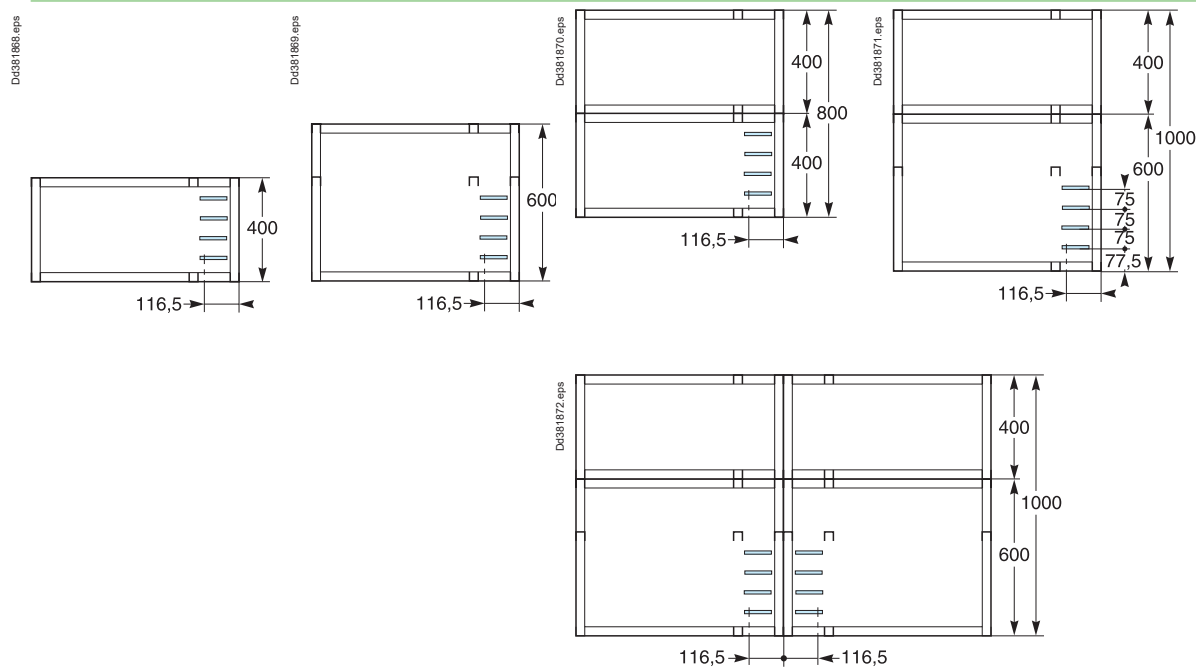

Double Linergy BS busbars.

Layout of rear Linergy BS busbars

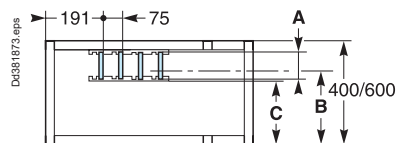

		A		
		50	60	80
D = 400 mm	B	284	274	254
	C	250	240	220
D = 600 mm	B	484	474	454
	C	450	440	420



Dimensions

Plain gland plates

A	C
300	110
400	210
650	460
800	610

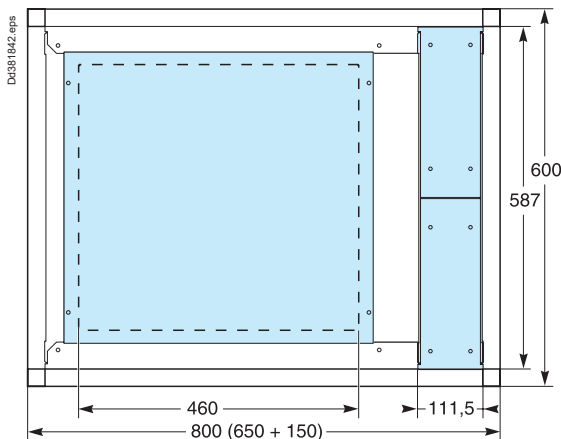
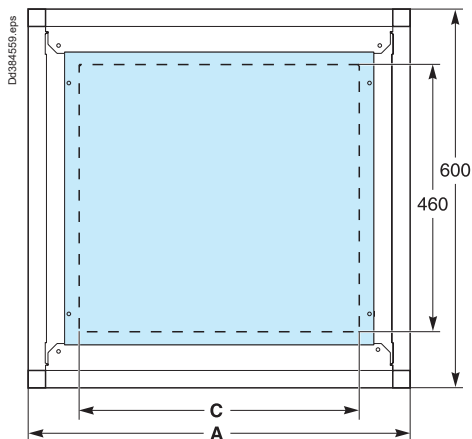
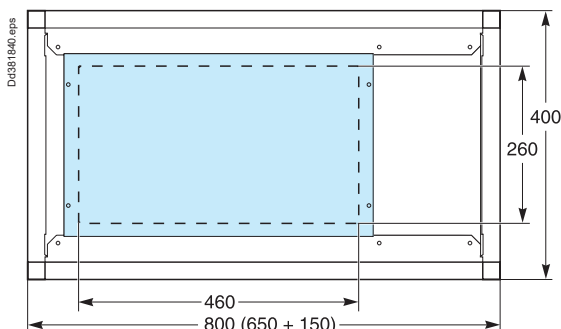
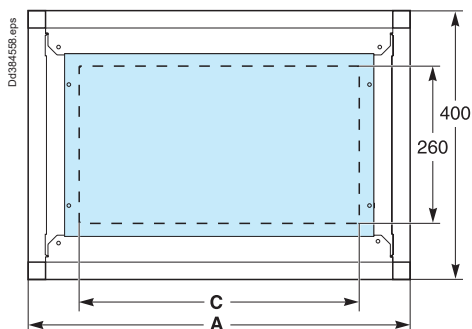
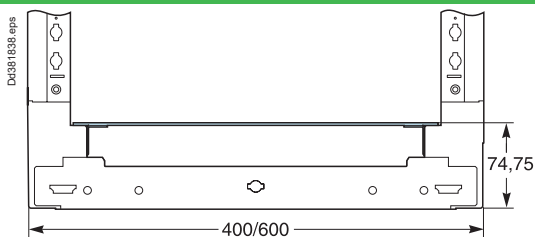

Dimensions

Two-part gland plates

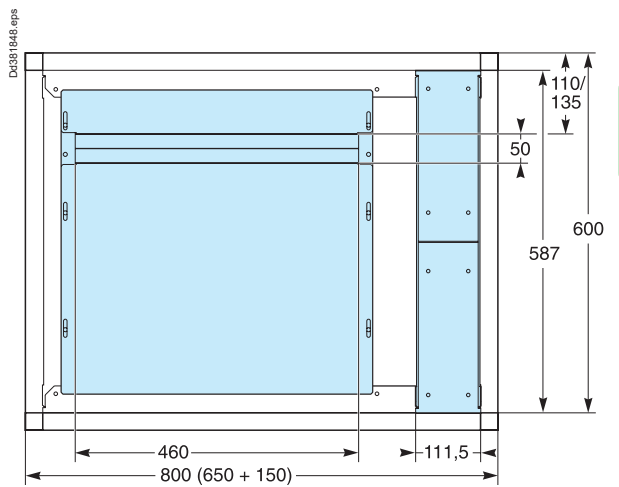
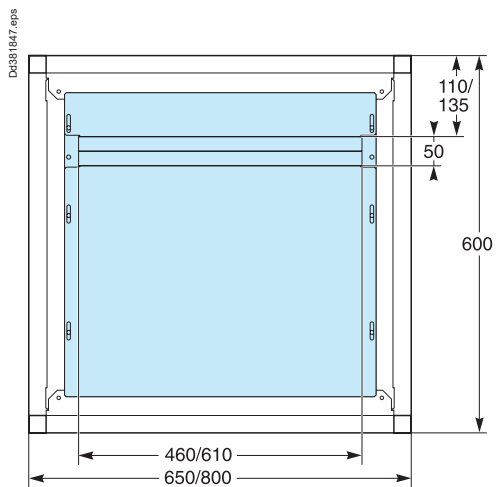
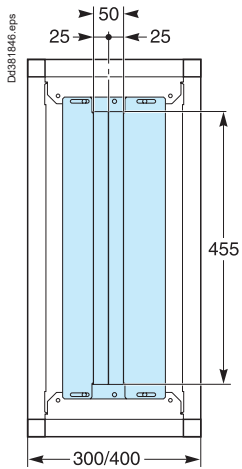
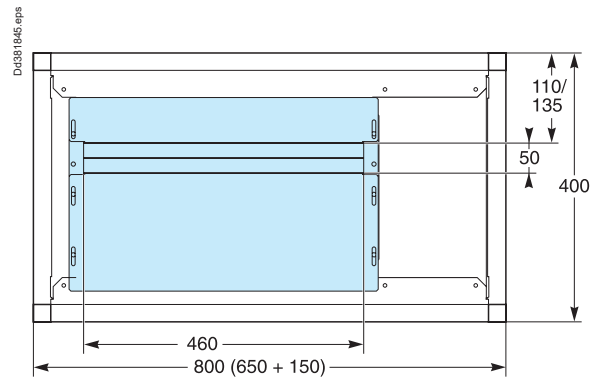
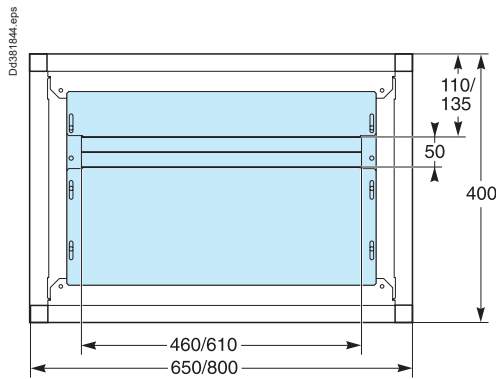
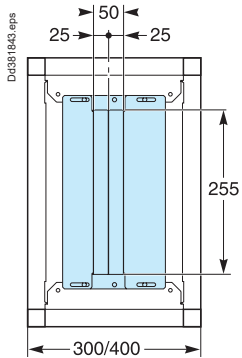
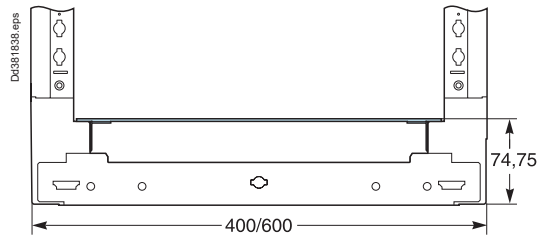



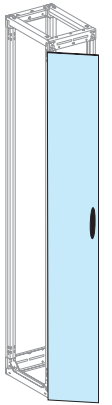
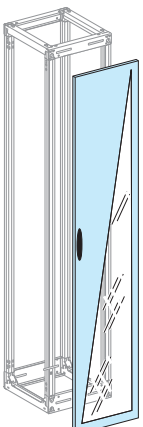
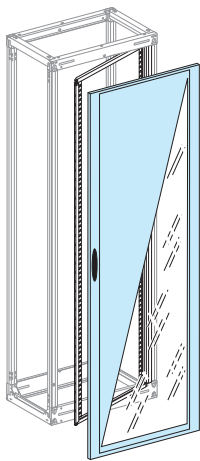
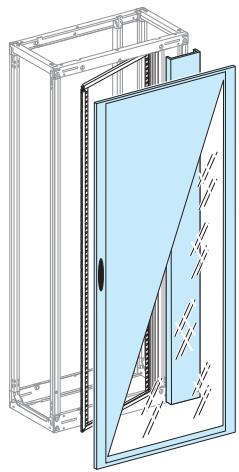

Cubicles

IP30/31 cover panels

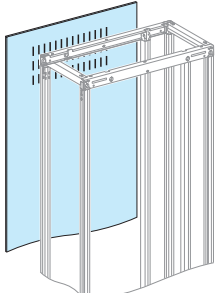
Enclosures

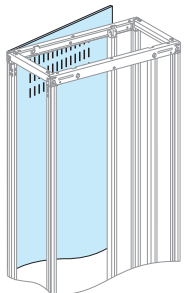
Mounting	Front doors			
				
Dimensions (mm)	W = 300	W = 400	W = 650	W = 800
Plain door	LVS08513	LVS08514	LVS08516	LVS08518
Transparent door	-	LVS08534	LVS08536	LVS08538
Door with cut-out	LVS08593	LVS08594	-	-
Reinforced plain door	-	-	LVS01224	LVS01225
Characteristics	<ul style="list-style-type: none"> ■ Reversible for left or right-hand opening IP31. ■ Equipped with a handle and keylock (key 405). ■ Plain door are IK10 with 3 hinges. ■ Reinforced plain door are IK10 with 3 hinges. ■ Transparent door are IK10 with 3 hinges. <p>For other possibilities > page F-29.</p> <p>Note: the door with cut-out can be equipped with front plates for 72 x 72 or 96 x 96 instruments > page E-66. The 800 mm door is supplied with a 150 mm barrier for the side compartment, plus a finishing accessory to improve the appearance of the upright.</p>			
Cover frame	-	LVS08574	LVS08576	LVS08578 (1)

Mounting	Rear panels			
				
Dimensions (mm)	W = 300	W = 400	W = 650	W = 800
Rear panel	LVS08733	LVS08734	LVS08736	LVS08738
Characteristics	<ul style="list-style-type: none"> ■ Made up of two half panels with vents. ■ Supplied with quarter-turn fasteners. 			

(1) For 800 mm wide frameworks, the 650 mm frame is supplied with a plain wicket door, 150 mm wide.

Cubicles

IP30/31 cover panels

Enclosures

Mounting Kit: Side Panels + Voltage Presence Indicator/Wireless Panel Server + adapted Green Cover

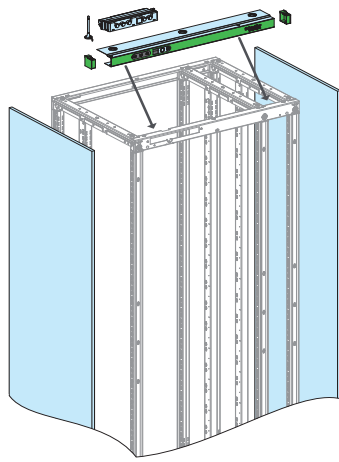

Dimensions (mm)	D = 400	D = 600
W 400	LVS08750D	LVS08760D
W 650	LVS08751D	LVS08761D
W 800	LVS08752D	LVS08762D

Characteristics	
	<ul style="list-style-type: none"> Supplied with quarter-turn fasteners. Voltage Presence Indicator to be installed on main incomer section.

Rear Side panels

Characteristics	
	<ul style="list-style-type: none"> For combinations of two cubicles with different depths like 800 (400+400) and 1000 (400+600). These panels cannot be installed on the front cubicles. <p>Note : For dimensions, Refer page F-18 Side panel dimensions.</p>

Dimensions (mm)	D = 400
Rear side panels	LVS08753
Side panels for L combinations	LVS08756

Roof

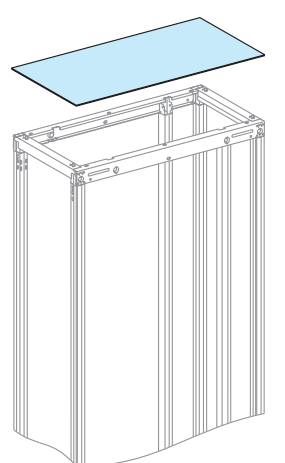

Dimensions (mm)	W = 300	W = 400	W = 650	W = 800
Plain roof D = 400 mm	LVS08433	LVS08434	LVS08436	LVS08438
Plain roof D = 600 mm	LVS08633	LVS08634	LVS08636	LVS08638

Characteristics	
	<ul style="list-style-type: none"> Supplied with quarter-turn fasteners for mounting on the framework With markings for cut-outs, if necessary.

IP31 sealing kit LVS08711

Characteristics	
	<p>The kit is made up of a self-adhesive gasket that attaches to the roof and a deflector. It ensures the IP31 degree of protection for a 650 or 800 mm wide cubicle, or for two cubicles (800 + 400) when they are equipped with plain or transparent front doors.</p>

Green Cover to fix on top of each frame

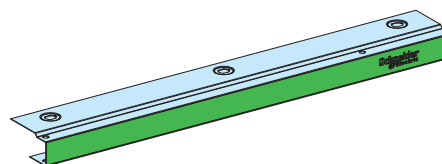

Dimensions (mm)	W = 300	W = 400	W = 650	W = 800
	LVS08640	LVS08641	LVS08642	LVS08643



Characteristics	
	To cover the top of each section which does not have Voltage Presence Indicator.



Cubicles

IP30/31 cover panels

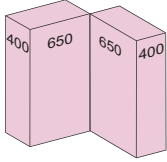
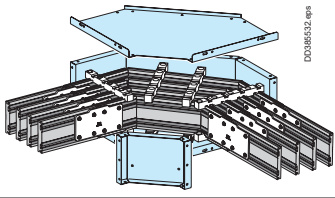
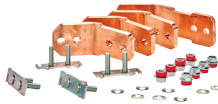
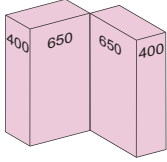
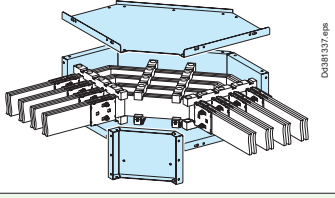
Right angle kit

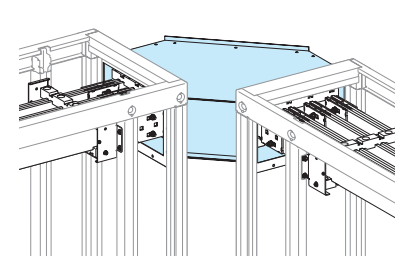



kit IP30 for Linergy LGYE	Right-angle	Fish plates kit		
				
cat. number	LVS08712	630-1600 A	2000-2500 A	3200-4000 A
Characteristics	<ul style="list-style-type: none"> ■ Metal duct with busbar supports ■ Used to create and protect the connection of horizontal busbars between two cubicles installed at right angles. ■ This kit needs a Linergy LGYE busbar of 1080 mm length. 	2 x LVS04610	2 x LVS04611	2 x LVS04613
		<ul style="list-style-type: none"> ■ Order the additional joint kit, comprising the 4 copper connections and mounting hardware: 		
kit IP30 for Linergy BS	Right-angle	Fish plates kit		
				
cat. number	LVS08713	bars H 50/60	bars H 80/100	
Characteristics	<ul style="list-style-type: none"> ■ Metal duct ■ Used to create and protect the connection of horizontal busbars between two cubicles installed at right angles. 	2 x LVS04640	2 x LVS04641	
		<p>Order:</p> <ul style="list-style-type: none"> ■ fixed support 2 x LVS04664 (if 100 x 10 bar, add 2 x LVS04671) ■ free support 2 x LVS04662 (if 100 x 10 bar, add 2 x LVS04671) 		
				

Cubicles

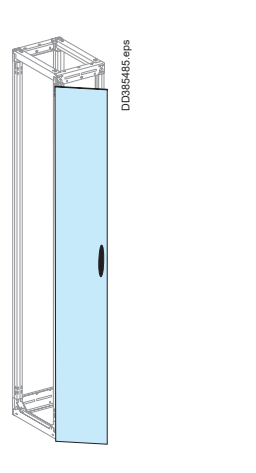
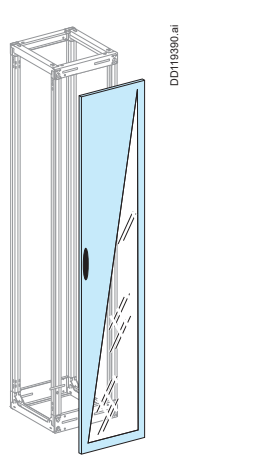
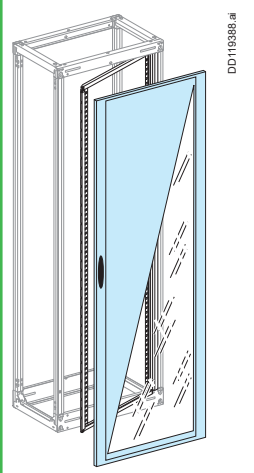
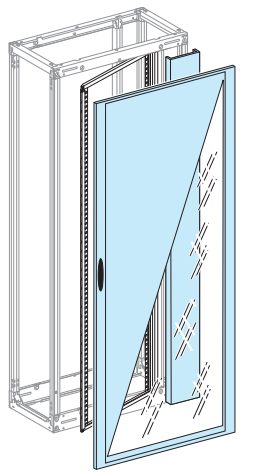
IP55 cover panels

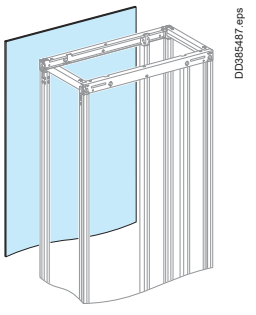
Enclosures

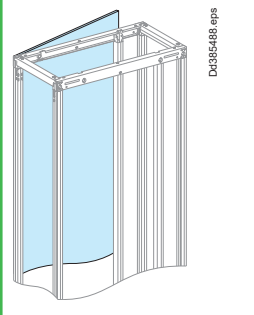
Mounting	Front doors			
				
Dimensions (mm)	W = 300	W = 400	W = 650	W = 800
Plain door	LVS08523	LVS08524	LVS08526	LVS08528
Transparent door		LVS08544	LVS08546	LVS08548
Characteristics	<ul style="list-style-type: none"> ■ Equipped with a factory-mounted polyurethane (PUR) gasket, IP55. ■ Reversible for left or right-hand opening ■ Equipped with a handle and keylock (key 405). <p>For other possibilities > page F-29.</p> <p>For IP55 rated configurations, front or rear mounted doors, it is necessary to follow the temperature derating tables, to ensure a convenient installation of devices.</p> <p>Note: the 800 mm door is supplied with a 150 mm barrier for the side compartment, plus a finishing accessory to improve the appearance of the upright.</p>			

Mounting	Rear panels			
				
Dimensions (mm)	W = 300	W = 400	W = 650	W = 800
Rear panel	LVS08743	LVS08744	LVS08746	LVS08748
Characteristics	<ul style="list-style-type: none"> ■ Equipped with a factory-mounted polyurethane (PUR) gasket ■ Supplied with mounting hardware. ■ One-piece, reinforced panel designed to ensure the degree of protection. 			



Cubicles

IP55 cover panels

Enclosures

Mounting Kit: Side Panels + Voltage Presence Indicator/Wireless Panel Server + adapted Green Cover

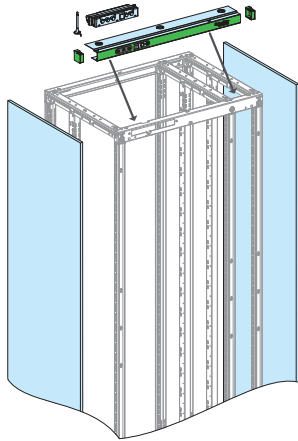

Dimensions (mm)	D = 400	D = 600
W 400	LVS08755D	LVS08765D
W 650	LVS08756D	LVS08766D
W 800	LVS08757D	LVS08767D
Rear side panels	LVS08763	-

Characteristics

- Supplied with quarter-turn fasteners.
- Voltage Presence Indicator to be installed on main incomer section.

Rear Side panels

Characteristics

- For combinations of two cubicles with different depths like 800 (400+400) and 1000 (400+600).
- These panels cannot be installed on the front cubicles.

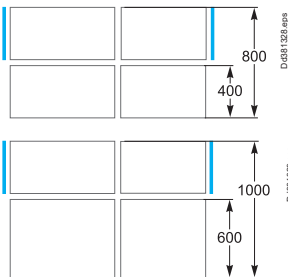

Dimensions (mm)	D = 400
Rear side panels	LVS08763
Side panels for L combinations	LVS08756

Characteristics

Left or right combinations of two cubicles with different depths(400 + 400 or 400 + 600). These panels simply replace the standard side panels.

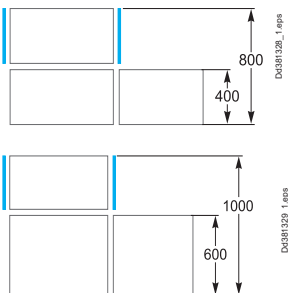

Mounting Roof

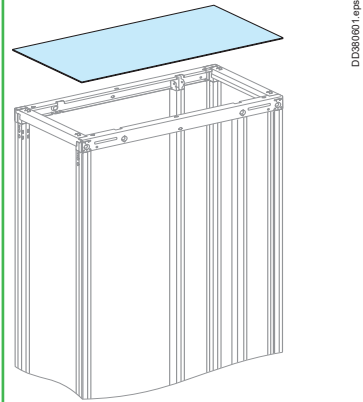

Dimensions (mm)	W = 300	W = 400	W = 650	W = 800
Plain roof D = 400 mm	LVS08453	LVS08454	LVS08456	LVS08458
Plain roof D = 600 mm	LVS08653	LVS08654	LVS08656	LVS08658

Characteristics

- Supplied with quarter-turn fasteners for mounting on the framework
- With markings for cut-outs, if necessary.

IP31 sealing kit LVS08711

Characteristics

The kit is made up of a self-adhesive gasket that attaches to the roof and a deflector. It ensures the IP31 degree of protection for a 650 or 800 mm wide cubicle, or for two cubicles (800 + 400) when they are equipped with plain or transparent front doors.

Green Cover to fix on top of each frame

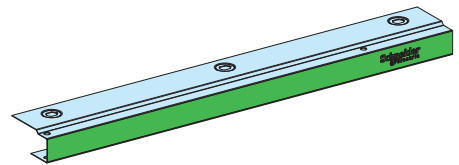

Dimensions (mm)	W = 300	W = 400	W = 650	W = 800
	LVS08640	LVS08641	LVS08642	LVS08643

Characteristics

To cover the top of each section which does not have Voltage Presence Indicator.

Cubicles

Plinth

Enclosures

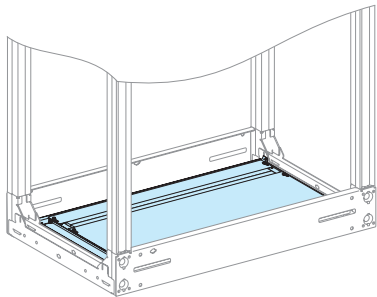
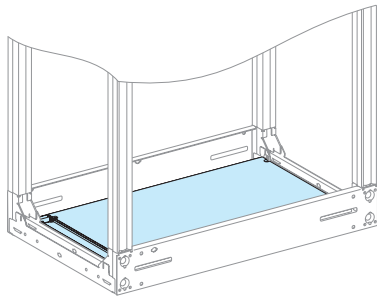
Mounting	Two-part gland plates		IP55, gland plates	
				
Degree of protection	IP30/IP31		IP55	
Dimensions (in mm)	D400	D600	D400	D600
W = 300 mm	LVS08493	LVS08693	LVS08483	LVS08683
W = 400 mm	LVS08494	LVS08694	LVS08484	LVS08684
W = 650 mm	LVS08496	LVS08696	LVS08486	LVS08686
W = 800 mm (650 + 150)	LVS08497	LVS08697	LVS08487	LVS08687
W = 800 mm	LVS08498	LVS08698	LVS08488	LVS08688

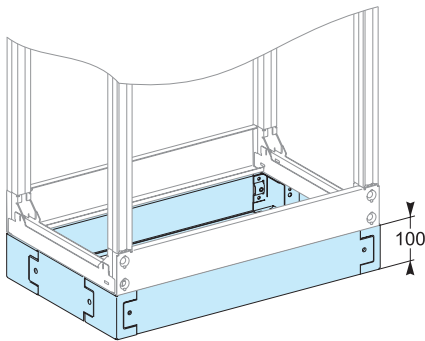
Mounting	Plinth H = 100 mm					
						
Dimensions (mm)	W = 300	W = 400	W = 650	W = 800	D = 400	D = 600
Four corner posts + two cross-pieces (front and rear)	LVS08723	LVS08724	LVS08726	LVS08728	-	-
Two side plates	-	-	-	-	LVS08720	LVS08721

Characteristics

The plinth is made up of two Catalog numbers:

- one Catalog number comprising four corner posts + two cross-pieces (front and rear), that can be used in side-by-side combinations or stacked to form a plinth 200 mm high (maximum)
- one Catalog number comprising two side plates (400 or 600 mm).

Each Catalog number is supplied with the necessary hardware.

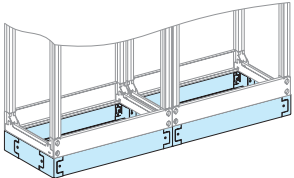
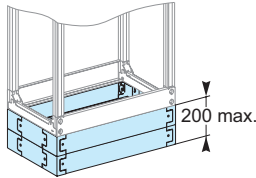
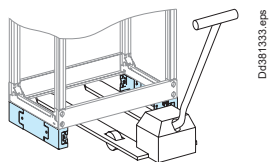
Examples
  
<p>Side-by-side combination of two cubicles with a plinth.</p> <p>Two stacked plinths.</p> <p>The front and rear cross-pieces can be easily removed for a pallet-mover.</p>



Cubicles

Cubicle handling and Lifting reinforcement kit

Enclosures

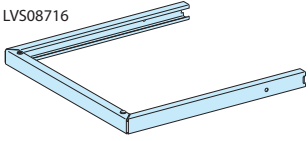
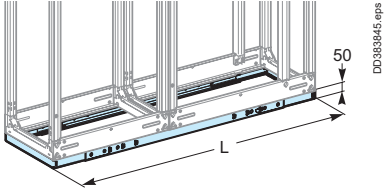
Mounting		Cubicle handling and rolling base				
						
Dimensions (mm)		D = 400	D = 600	L1200 to L1900	L2000 to L2550	L2650 to L3050
2 cubicle handling base end-pieces		LVS08714	LVS08716	-	-	-
Cubicle handling		-	-	-	LVS08706	-
Characteristics	This type of base is designed to avoid any risk of cubicle deformation during transport and handling. Five different Catalog numbers offer 27 width possibilities (1200 to 3050 mm) for 400 and 600 mm deep cubicles. <ul style="list-style-type: none"> b Two Catalog numbers each include 2 end-pieces for handling bases for 400 and 600 mm deep cubicles respectively and the corresponding mounting hardware. b Three Catalog numbers each include 2 lengths for the sides of handling bases for 1200 to 3050 mm wide cubicles respectively and the corresponding mounting hardware. Handling bases can be used for both side-by-side and back-to-back cubicle combinations. In this case, the mounting hardware for one of the sets is used.					

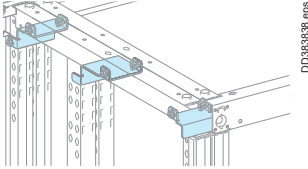
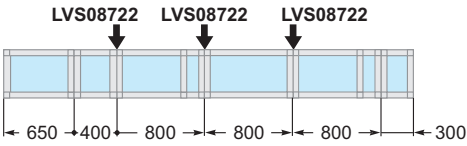
Mounting		Lifting reinforcement kit	
			
Dimensions (mm)		D = 400, D = 600	
Lifting reinforcement kit		LVS08722	
Characteristics	Kit LVS08722 is recommended for lifting combined cubicles and can be used together with handling base end-pieces LVS08714 or LVS08716 for severe transport or handling conditions. Catalog number LVS08722 includes 3 reinforcement brackets for 400 or 600 mm deep cubicles and the corresponding mounting hardware.		

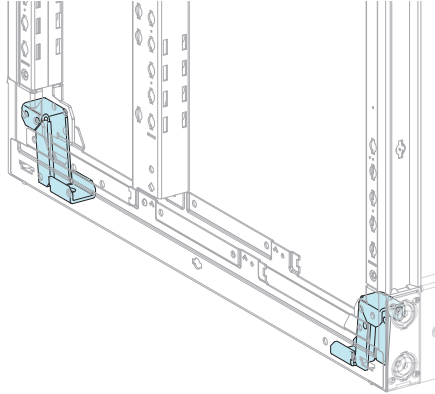
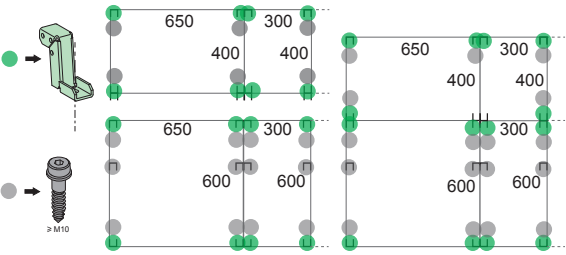
Mounting		Seismic Kit	
			
		Foot part to be added in each bottom angle to reinforce the structure.	
Reinforcement bracket		LVS08710	
Characteristics	Catalog number ref LVS08710 includes 1 reinforcement bracket and 4 M6 screws. <ul style="list-style-type: none"> b Plinths are not allowed with seismic kits. 		

Type of cubicle	W300		W400		W650		W650 + W150	
	D = 400	D = 600	D = 400	D = 600	D = 400	D = 600	D = 400	D = 600
Framework	LVS08403	LVS08603	LVS08404	LVS08604	LVS08406	LVS08606	LVS08407	LVS08607
Reinforcement bracket	LVS08710 x 4				LVS08710 x 4		LVS08710 x 6	
Longitudinal cross men	LVS08773		LVS08774		LVS03587 x 2			
Lateral cross member	LVS03584 x 2	LVS03584 x 2 + LVS03586 x 2	LVS03584 x 2	LVS03584 x 2 + LVS03586 x 2	LVS03584 x 2		LVS03584 x 2 + LVS03586 x 2	
M10 screw (not supplied)	4	6	4	6	4		6	
Side panels IP55 mandatory for IP30 and IP55 configurations	LVS08755	LVS08765	LVS08755	LVS08765D	LVS08755	LVS08766D	LVS08757D	LVS08767D

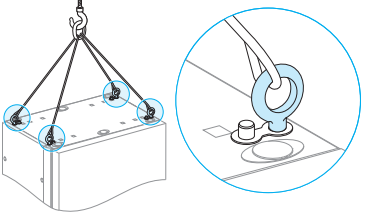
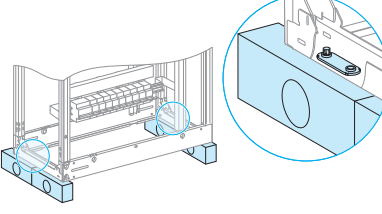
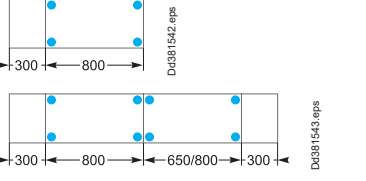
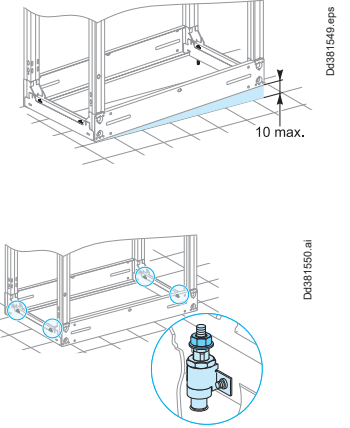
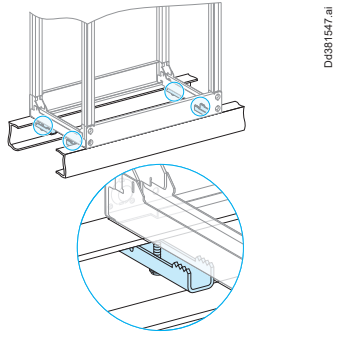
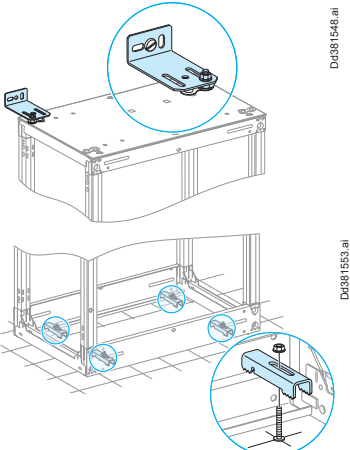
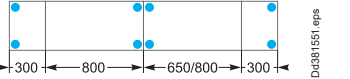
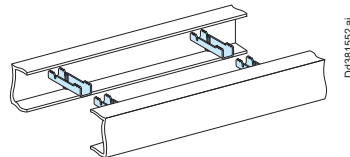
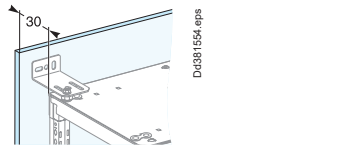
Mounting	Lifting rings	Framework stabiliser kit	
	 <p style="text-align: right; font-size: small;">Dd381541.ai</p>	 <p style="text-align: right; font-size: small;">Dd383846.ai</p>	
Cat. no.	LVS08700	LVS08701	
Characteristics	<ul style="list-style-type: none"> ■ Set of four lifting rings screwed to the framework. ■ Use a set of lifting rings for each framework (W = 650 and 800 mm) containing devices. ■ When two cubicles with devices have been combined, use a lifting beam. ■ can be installed and removed without removing the roof ■ even if they are left attached, the switchboard conserves its original degree of protection.  <p style="font-size: x-small;">Positions of the lifting rings for two combined cubicles containing devices. In this case, a liftingbeam must be used.</p>	<ul style="list-style-type: none"> ■ Made up of four blocks under the framework ■ Suitable for all types of cubicles, whatever the width and depth ■ Increases the stability of the cubicle during mounting of devices ■ Makes possible cubicle handling using a pallet mover or a forklift ■ Protects the front, side and rear cover panels during handling ■ Can be reused. 	
Mounting	Levelling kit	False floor fixing kit	Floor/wall fixing kit
	 <p style="text-align: right; font-size: x-small;">Dd381548.eps Dd381550.ai</p>	 <p style="text-align: right; font-size: x-small;">Dd381547.ai</p>	 <p style="text-align: right; font-size: x-small;">Dd381548.ai Dd381553.ai</p>
Cat. no.	LVS08702	LVS08703	LVS08704
Characteristics	<ul style="list-style-type: none"> ■ Set of 4 fixtures ■ can be installed at any time, even when the cubicle is already in position ■ maximum adjustment range = 10 mm ■ secures the cubicle to the floor.  <p style="font-size: x-small;">Recommended positions of the fixtures for combined cubicles.</p>	<ul style="list-style-type: none"> ■ Made up of four independent clamps ■ clamp on: <ul style="list-style-type: none"> ✓ "U" sections: H = 175 mm, W = 70 mm ✓ "I" sections: H = 120 mm, W = 64 mm ■ clamp travel = 11 mm.  <p style="text-align: right; font-size: x-small;">Dd381552.ai</p>	<ul style="list-style-type: none"> ■ Made up of two brackets and four clamps ■ can be used to offset the switchboard fixing points for easier access ■ the wall brackets ensure sufficient wall clearance (at least 30 mm) for natural convection.  <p style="text-align: right; font-size: x-small;">Dd381554.eps</p>



Front plate accessories

Front plate accessories, blanking plates

Enclosures

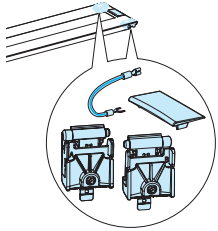
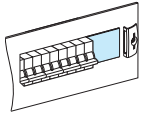
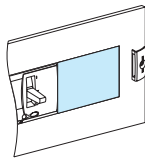
Used for	Front plate hinge kit	Blanking plates			
					
Cat. no.	LVS08585 (1)	For modular devices LVS03220	LVS03221	For ComPact NSX100/250 LVS03249	LVS03222
Characteristics	<ul style="list-style-type: none"> Set of 2 hinges 1 earthing braid 	<ul style="list-style-type: none"> Strip H = 46 mm, L = 1 m 	<ul style="list-style-type: none"> Divisible Set of 4 H = 46 mm, L = 90 mm White RAL 9003 	<ul style="list-style-type: none"> Divisible H = 85 mm, L = 147 mm Blanc RAL 9003 	<ul style="list-style-type: none"> Divisible + electronic trip unit



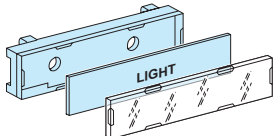
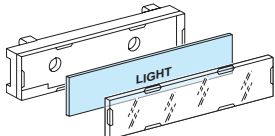

(1) With a power voltage > SELV (12 V), devices on front plates must be mounted with a front plate hinge kit (cat no. LVS08585). The earthing braid must be connected to the front plate frame support (cat no. **LVS08566, LVS08564, LVS08560, LVS08562** or else).
 With a power voltage > SELV (12 V) and a supply protection > 16 A, in addition to the preceding rule, the front plate frame support (cat no. **LVS08566, LVS08564, LVS08560, LVS08562** or else) must be connected to the cubicle frame, using an earthing braid (cat no. **LVS08910** or **LVS08911**). (standard NF / EN 61439-1 2011 edition).

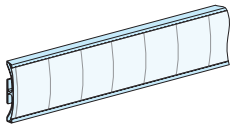
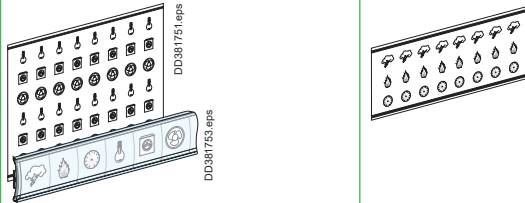
Identification labels

Used for	Clip-on labels			Engraving plates		
						
Cat. no.	LVS08913	LVS08915	LVS08917	LVS08914	LVS08916	LVS08918
Dimensions (mm)	18 x 35	18 x 72	25 x 85	18 x 35	18 x 72	25 x 85
Characteristics	<ul style="list-style-type: none"> Set of 12. The clip-on support is supplied with a paper label and a transparent cover. It clips onto the front plate horizontally or vertically and can be screwed to any support (plain door, plain front plate, etc.). 			<ul style="list-style-type: none"> Set of 12. Simply replace the paper labels. 		

Used for	Adhesive labels				Symbol sheets	
						
Cat. no.	LVS08905	LVS08906	LVS08903	LVS08904	13735	13736
Dimensions (mm)	24 x 180	36 x 180	24 x 432	36 x 432		
Characteristics	<ul style="list-style-type: none"> Set of 12. The adhesive label holders are supplied with a paper label and a transparent cover 				<ul style="list-style-type: none"> Set of ten symbol sheets. Standard symbols: <ul style="list-style-type: none"> loads: sockets, lights, heating units, etc. rooms: bedroom, bathroom, etc. Special symbols: <ul style="list-style-type: none"> loads: lightning arrester, gate, swimming pool, etc. rooms: technical room, computer room, etc 	

Adhesive labels for mimic diagrams

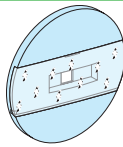
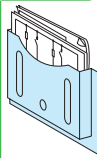
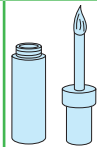

Used for	Lines	Outgoing arrows	Incoming arrows	Transformers
	 x 10	 x 10	 x 10	 x 10
Cat. no.	LVS01005	LVS01006	LVS01007	LVS01008
Characteristics	900 mm long and 7 mm thick Set of 10			

Accessories

Used for	Switchboard identification plate	Drawing holder	Touch-up accessories
			
Cat. no.	LVS08900	LVS08963	LVS08961
Characteristics	Color: RAL 9003	Color: RAL 9003	Color: RAL 9003

Reserve space

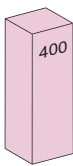
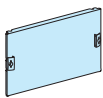
Others

Reserve space	
	 DB417928.eps
Plain front plate W = 250 mm	
	H = 50 mm H = 100 mm H = 150 mm H = 200 mm H = 250 mm H = 300 mm H = 450 mm H = 600 mm
[No. of vertical mod.]	[1] [2] [3] [4] [5] [6] [9] [13]
Catalog number	LVS03811 LVS03812 LVS03813 LVS03814 LVS03815 LVS03816 LVS03817 LVS03722
	 DB417929.eps
Transparent front plate W = 250 mm	
[No. of vertical mod.]	- - - [4] - [6] [9] -
Catalog number	- - - LVS03352 - LVS03353 LVS03354 -

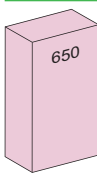
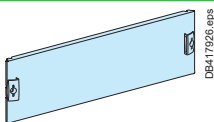
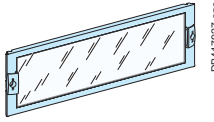
Reserve space	
	 DB417926.eps
Plain front plate W = 500 mm	
	H = 50 mm H = 100 mm H = 150 mm H = 200 mm H = 250 mm H = 300 mm - H = 600 mm
[No. of vertical mod.]	[1] [2] [3] [4] [5] [6] - [12]
Catalog number	LVS03801 LVS03802 LVS03803 LVS03804 LVS03805 LVS03806 - LVS03808
	 DB417927.eps
Transparent front plate W = 500 mm	
[No. of vertical mod.]	- - - [4] - [6] [9] [12]
Catalog number	- - - LVS03342 - LVS03343 LVS03344 LVS03345



Fixing accessories

Others

Clip-nuts

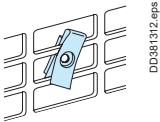
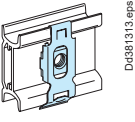
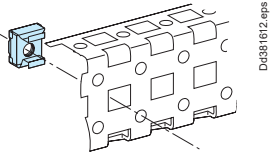
Mounting	For slotted mounting plates	For modular rails	For lateral and longitudinal cross-members
			
M4	LVS03180	LVS03164	-
M5	LVS03181	LVS03165	-
M6	LVS03182	LVS03166	LVS03194
Characteristics	Set of 20 Mounting of various devices	Set of 20 Mounting of various devices	Set of 20 Mounting in cubicles

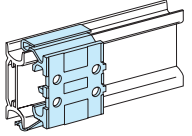
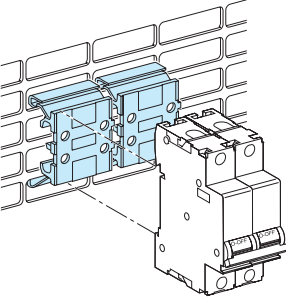

Pratic raiser

Raiser	
	 
Catalog number	LVS04224
Characteristics	Set of 5 Height 10 mm, wide 27 mm Color: RAL 9003, insulating material

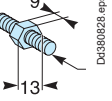
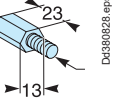
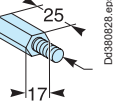
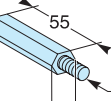
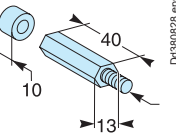
Hexagonal spacers

Hexagonal spacers					
					
M5	LVS03185	LVS03186	-	LVS03187	-
M6	LVS03195	LVS03196	LVS03198	LVS03197	-
M8	-	-	-	-	LVS03199
Characteristics	Height: 9 mm Set of 4	Height: 23 mm Set of 4	Height: 25 mm Set of 4	Height: 55 mm Set of 4	Height: 40 + 10 mm Set of 4

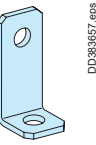
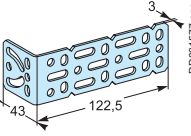
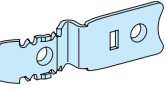
Universal angle brackets

Universal angle brackets					
					
Catalog number	LVS03580	LVS03581	LVS03582	LVS03583	LVS04667
Characteristics	Set of 4 + vis	Set of 2	6 universal inserts	Set of 6	Set of 2

Universal adapter

PrismaSeT G Active adapter

Mounting on a plain backplate

Others

PrismaSeT G Active adapter

	W = 500	W = 250
Catalog number	LVS03595	LVS03596
Characteristics	For installation in a device compartment W = 650 mm	For installation in a device compartment W = 400 mm
	Kit with four lateral and two longitudinal cross-members that can be depth adjusted. Installation of components, notably the functional mounting plates, the Linergy BW insulated busbars and the 400 A rear Linergy BS busbars.	

Mounting on a plain backplate

Mounting	Plain backplate	Slide rails + angle brackets	
Catalog number	LVS03570	LVS03569	LVS03593
Characteristics	36 modules 510 mm wide for installation in a device compartment W = 650 mm or W = 800 mm (650 + 150)	36 modules 660 mm wide for installation for a cubicle W = 800 mm	Set of 2 for the installation and depth adjustment

Note: the adapter **LVS03595** can be used for all mounting plates, except **LVS03030**.

The Linergy BW busbars can be positioned to the left, middle or right of the modular row.

Depth adjustable, the busbars can be supplied by a ComPacT INS-INV switch-disconnector or a fixed/withdrawable ComPacT NSX circuit breaker, whatever the type of operating system (toggle, rotary handle, motor mechanism).

For Linergy BW busbars, order two adapters (**LVS03595** x 2).



Others devices

Mounting on a slotted plate



Mounting on a modular rail

Others

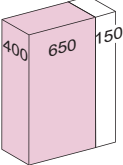
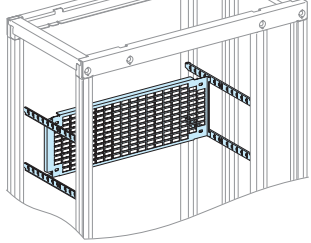
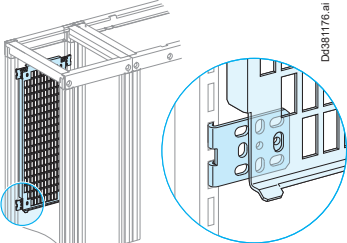
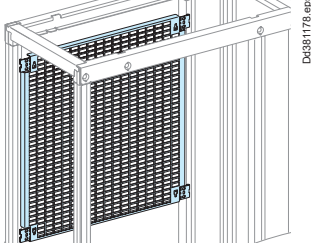
Mounting on a slotted plate

Mounting	Slotted mounting plates + lateral cross-members		Slotted mounting plate without lateral cross-members
			
Catalog number	LVS03571	LVS03572	LVS03574
Number of vertical modules	4	6	12
Height (mm)	200	300	600
2 universal angle brackets	-	2 x LVS03581	-
Characteristics	<p>Installation</p> <ul style="list-style-type: none"> ■ either in the device zone on the four lateral cross-members (depth adjustment is possible) ■ or vertically at the rear of a cable compartment, W = 300 mm (LVS03571) or W = 400 mm (LVS03572). 		<p>Galvanised, slotted metal mounting plate</p> <p>Supplied with four angle brackets, they connect directly to the rear of a framework, W = 650 mm or 800 mm (650 + 150 mm)</p> <p>The mounting plate can also be installed using two sets of two slide rails (LVS03593 x 2) for depth adjustment.</p>

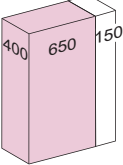
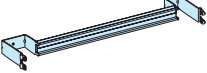
Mounting on a modular rail

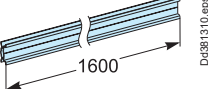
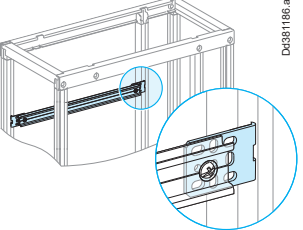
Mounting	Modular rails			Modular rail W = 650 mm
				
Catalog number	LVS03401	LVS03402	LVS04226 (1)	LVS03590
Characteristics	Useful length: 432 mm	Useful length: 432 mm Modular rail (adjustable)	Set of 2 rails, useful length: 1600 mm with 4 holes, Ø 6.4 mm, 450 mm between centres	W = 650 mm Supplied with two angle brackets for mounting on the framework

(1) Example of a Linergy busbars installed in a busbar compartment, on a modular rail cat. no. **LVS04226 + LVS03581 + LVS08794**: > page G-38.

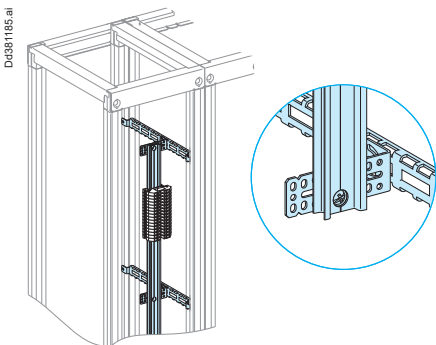

Straps and covers

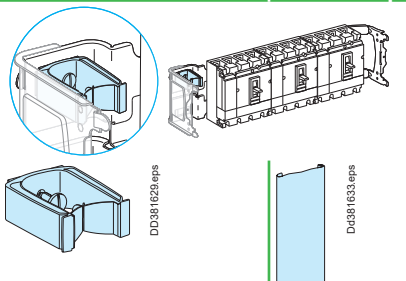
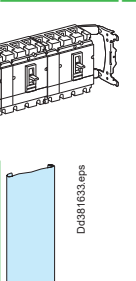
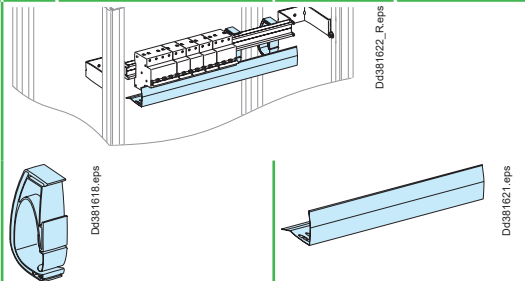
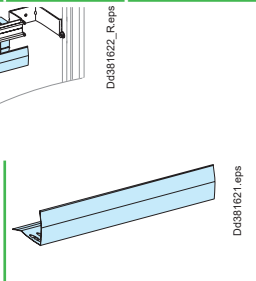
Type	Vertical cable straps	Covers for vertical cable straps	Horizontal cable straps	Covers for horizontal cable straps
				
Catalog number	LVS04262	LVS04263	LVS04239	LVS04243
Characteristics	Set of 12	Set of 2 x 1 m	Set of 12 Horizontal cable straps have the same capacity as 60 x 30 mm trunking.	Set of 4 covers of 430 mm

Trunking supports

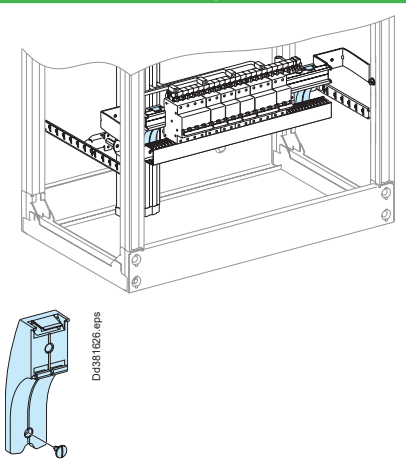
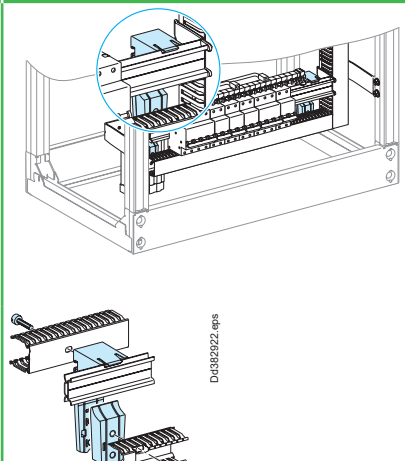

Type	Horizontal trunking supports	Adaptable support for horizontal trunking
		
Catalog number	LVS04255	LVS04256
Characteristics	Set of 12	Set of 10 Aligns the cover of a horizontal trunking section (H = 60 or 80 mm) with that of a vertical trunking section (H = 80 mm) Note: not designed for use with Pack enclosures.

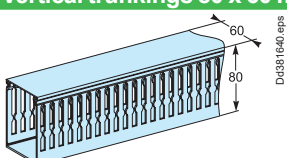
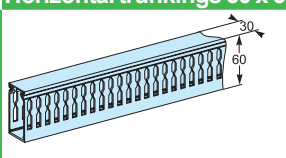
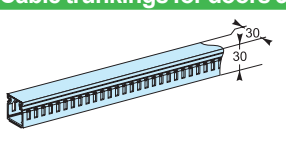

Trunkings

Type	Vertical trunkings 80 x 60 mm	Horizontal trunkings 60 x 30 mm	Cable trunkings for doors 30 x 30 mm
			
Catalog number	LVS04267	LVS04257	LVS04233
Characteristics	Set of 18 L = 2000 mm	Set of 4 L = 450 mm Supplied with supports	Set of 30 adhesive trunkings 30 x 30 mm L = 2000

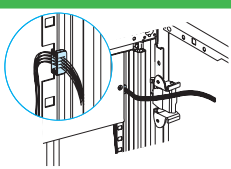
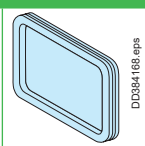
Cable trunkings for doors, grommets

Type	Flexible trunkings for wiring to door	Grommets		
				
Catalog number	LVS04235	LVS04234	LVS01215	87648
Characteristics	W = 500 mm, inner Ø = 19 mm	Set of 10. For wiring through front.	5 square grommets 70 x 40.	50 grommets Ø22 mm.

Connection accessories

Cable-tie supports, lateral and longitudinal cross-members

Others

Mounting	Longitudinal cable-tie supports				Lateral cable-tie supports	
Catalog number	LVS08773	LVS08774	LVS08776	LVS08778	LVS08794	LVS08796
Characteristics	W = 300 mm	W = 400 mm	W = 650 mm	W = 800 mm	D = 400 mm	D = 200 mm
	Set of 4, supplied with the necessary hardware for connection to the framework. Cable-tie supports are used to correctly position the cables in the connection compartment.				For frameworks that are 400 mm deep, assign a 400 mm deep support to a 200 mm deep support.	

Mounting	C-shaped cable-tie supports
Catalog number	LVS08783
Characteristics	<p>C-shaped 1600 mm long support, supplied with hardware for mounting on universal angle brackets and modular rails, that can be cut to length as needed.</p> <p>Can be secured to:</p> <ul style="list-style-type: none"> ■ universal angle bracket LVS03581 (for the longitudinal support) ■ universal angle bracket LVS03582 (for the lateral support) ■ modular rail LVS03593 (for depth adjustment).

Mounting	Lateral cross-members	Longitudinal cross-members	
Catalog number	LVS03584	LVS03586	LVS03587
Characteristics	<p>Set of 2</p> <p>W = 400 mm: for frameworks that are 400 mm deep</p>	<p>Set of 2</p> <p>W = 200 mm: can be added to the 400 mm crossmembers for frameworks that are 600 mm deep. They can also be installed separately.</p>	<p>Set of 2</p> <p>W = 650 mm</p> <p>They are connected directly to the framework (W = 650 mm). They can also be mounted on the lateral cross-members.</p>
	Metallics, they offer numerous positioning holes for easier installation.		

Door handles and locks





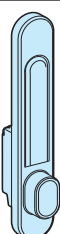
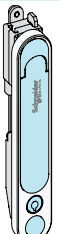
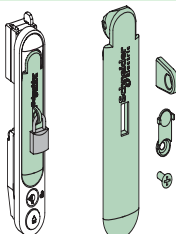

Others

Handles and padlocking

	EURO handle	ASSA/ABLOY handle	RAL 7016 rotary handle	Padlocking
	 Dd119386.ai	 Dd119397.ai	 mra231101_1.eps	 mra231101-p_2.eps
Cat. no.	LVS07932	LVS07933	LVS07931	LVS07938
Characteristics	Supplied without barrel	Supplied without barrel	Supplied with barrel lock (key no. 405) RAL 7016	For new rotary handle

New Barrel locks and inserts

The barrel locks and inserts below can mount on all the door handles of PrismaSeT P range after removing the standard barrel lock (key n°405)".

Rotary handle and inserts		Characteristics	Catalog numbers
 mra231101_1.eps		1 key no. 405	LVS07940
		2 keys no. 455	LVS07941
		2 keys no. 1242E	LVS07942
		2 keys no. 3113A	LVS07943
		2 keys no. 2433A	LVS07944
		2 keys no. 2432E	LVS07956
		DIN double bar insert	LVS07945
		Screwdriver slot insert	LVS07946
		Male triangle insert 8 mm	LVS07949
		Male square insert 6 mm	LVS07951
Male square insert 8 mm		LVS07953	

F

Earthing braid

Earthing braid is used to earth a door or wicket door with devices.

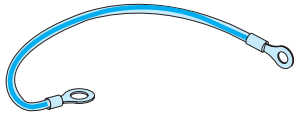
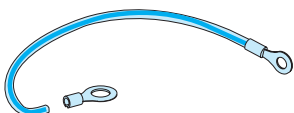



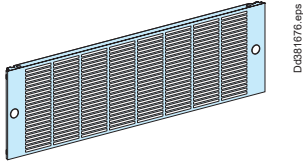

	Earthing braid, 6 mm ²	Earthing wire, 6 mm ²
	 DD384368.eps	 DD384369.eps
Catalog numbers	LVS08910	LVS08911
Characteristics	Equipped with a 4 mm diameter lug at one end and a 6 mm diameter lug on the other. W = 200 mm.	Equipped with a 5 mm diameter lug at one end and a 6 mm diameter lug on the other. W = 200 mm

Ventilation accessories

Panel installation

Others

Front plate	Ventilated front plate	
		
Cat. no.	LVS03891	LVS03895
Height	1 vertical module, H = 50 mm	3 vertical modules, H = 150 mm
Characteristics	Degree of protection: IP30. Located at the top and bottom of the switchboard, ventilated front plates facilitate natural convection in the switchboard.	
Surface area of the openings	80 cm ²	250 cm ²

Forced-air ventilation	38 m ³ /hr	85 m ³ /hr	165 m ³ /hr	300 m ³ /hr	560 m ³ /hr	850 m ³ /hr
						
Cat. no.	NSYCVF38M230PF	NSYCVF85M230PF	NSYCVF165M230PF	NSYCVF300M230PF	NSYCVF560M230PF	NSYCVF850M230PF
Unimpeded throughput via filter (m ³ /hr)	50 Hz	38	85	165	300	562
	60 Hz	39	98	193	350	586
Throughput via outlet grill (m ³ /hr)	50 Hz	25	63	153 (1)	260	473
	60 Hz	26	72	171 (1)	307	477
Power drawn (W) (max. intensity (A))	4,5/4,8 (0,16/0,17)	17/15 (0,121/0,097)	16,3/14,3 (0,12/0,94)	36/37 (0,171/0,16)	68/85 (0,52/0,370)	150/195 (0,65/0,85)
Noise level (dB (A))	40/41	46/49	50/51	55/56	59/59	76/75
External dimensions (cutting)	137 x 117 x 49 (92 x 92)	170 x 150 x 62 (125 x 125)	268 x 248 x 104 (223 x 223)	268 x 248 x 116 (223 x 223)	336 x 316 x 161 (291 x 291)	336 x 316 x 162 (291 x 291)
Weight (kg)	0,220	0,780	1,140	1,3	3,2	4,1
Operating temperature	-10...+70 °C	-20...+60 °C	-20...+60 °C	-10...+70 °C	-15...+60 °C	-15...+60 °C

Outlet grill						
Cat. no.	NSYACAG92LPF	NSYACAG125LPF	NSYACAG223LPF	NSYACAG223LPF	NSYACAG291LPF	NSYACAG291LPF

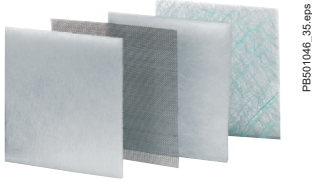
Filters for outlet grill						
						
G2 M1 standard filters	NSYCAF92	NSYCAF125	NSYCAF223	NSYCAF223	NSYCAF291	NSYCAF291
G3 M1 fine filters	-	NSYCAF125T	NSYCAF223T	NSYCAF223T	NSYCAF291T	NSYCAF291T
Characteristics	Set of 5 (for replacement) Synthetic filters					

EMC cover						
Cat. no.	-	NSYCAP125LE	NSYCAP223LE	NSYCAP223LE	NSYCAP291LE	NSYCAP291LE

(1) For 2 outlet grills 161 (50 Hz) / 175 (60 Hz).

Nota : For other usage voltage like 50V or 110V, see Universal Enclosures catalog, cat. no. UE12MK01EN.

Dimensions

NSYCVF38M230PF

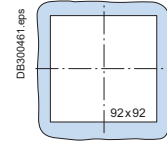
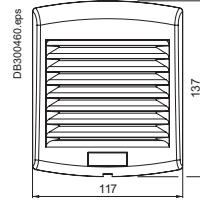
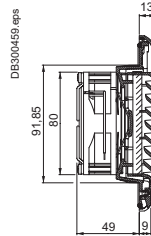

NSYCVF85M230PF

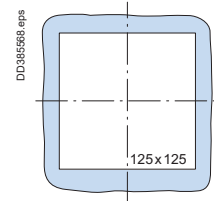
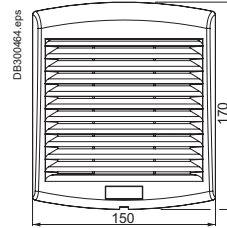
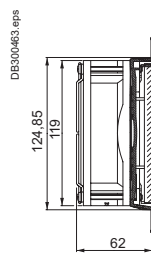

NSYCVF165M230PF

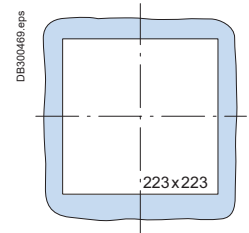
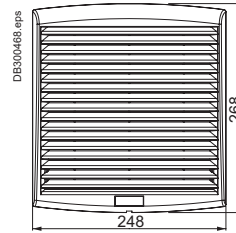
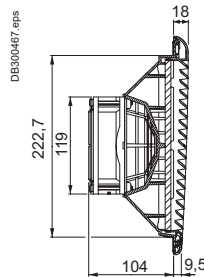

NSYCVF300M230PF

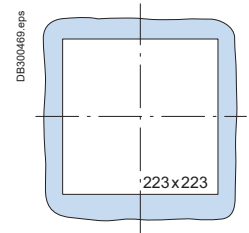
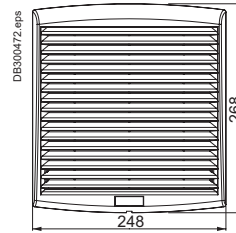
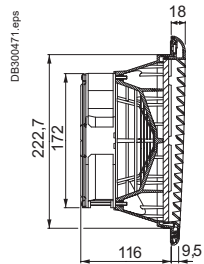

NSYCVF560M230PF - NSYCVF850M230PF

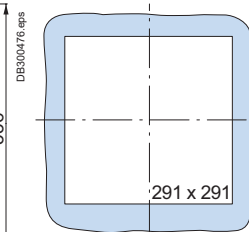
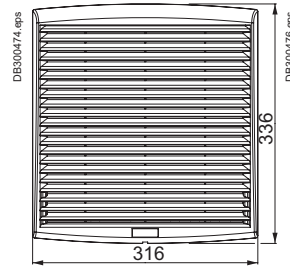
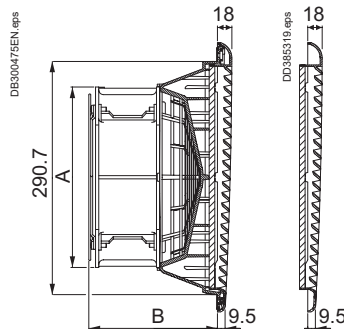

A	B	Cat. no.
225	160.5	NSYCVF560M230PF
280	192	NSYCVF850M230PF



Ventilation accessories

Roof installation



Others

Roof ventilation	Width 650, IP31		Width 800, IP54	
	NSYCVF575M230MB or NSYCAC228RMB		2 x NSYCVF575M230MB or 2 x NSYCAC228RMB	
Roof with a cut-out	D = 400 mm	D = 600 mm	D = 400 mm	D = 600 mm
Catalog numbers	LVS08476	LVS08676	LVS08478	LVS08678
Characteristics	IP31	IP31	IP54	IP54
Forced ventilation top hood with fan				
Catalog numbers	NSYCVF575M230MB			
Characteristics	Fan characteristics <ul style="list-style-type: none"> ■ Power: 85 W ■ Input voltage: 230 V ■ Throughput via outlet grill : <ul style="list-style-type: none"> □ with 1 outlet grill: 350 m³/hr □ Free with filter: 575 m³/hr □ Finishing parts: painted with epoxy-polyester resin, textured RAL 9003 white ■ Noise level: 64 dB. 			
Natural ventilation top hood without fan				
Catalog numbers	NSYCAC228RMB			
Characteristics	<ul style="list-style-type: none"> ■ Material: steel ■ Finishing parts: painted with epoxy-polyester resin, textured RAL 9003 white ■ IP54 ■ Fixing to the top by means of caged nuts and special screws 			
Air-flow cross section = 304 cm² without electrical fan			2 x 304 cm²	

Resistors

Resistors prevent condensation, corrosion and superficial leakage currents. They maintain a positive temperature in the enclosures and cubicles when external temperatures drop very low.

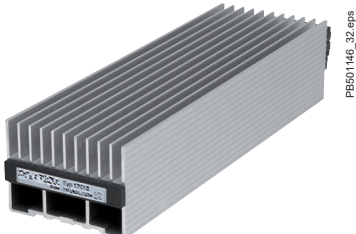
- Install heaters according to the desired power level at the bottom of the enclosure
- Respect a safety area of a least 10 cm around the device
- The heaters must be installed with a thermal controller to control the temperature or the humidity inside the enclosure.
- The enclosure must be sealed to prevent the entry of air from the outside.
- An electrical protection device must be installed on the supply side of the unit.
- Surface temperature limited to 75 °C when the ambient temperature is -5 °C.
- Heaters equipped with a power cable with a length of 500 mm with silicon insulation, or with a connection terminal block.

	Aluminium PTC resistors					Resistive heaters with fan	
							
	Power cord		Terminal block			Terminal block	
Cat. no.	NSYCR10WU2	NSYCR20WU2	NSYCR55WU2	NSYCR100WU2	NSYCR150WU2	NSYCR250W230VV	NSYCR400W230VV
Power rating (W)	10	25	55	90	150	250	400
Voltage (V)	110-250 AC	110-250 AC	110-250 AC	110-250 AC	110-250 AC	230 AC	230 AC
Characteristics	<ul style="list-style-type: none"> ■ Vertical mounting. ■ Aluminium case with fins. ■ Temperature: <ul style="list-style-type: none"> □ turns off at 60 °C, □ turns on at 25-30 °C (temperature of the resistor itself). ■ Equipped with a symmetrical 					<ul style="list-style-type: none"> ■ Vertical mounting. ■ Aluminium case with fins. ■ Temperature: <ul style="list-style-type: none"> □ turns off at 60 °C, □ turns on at 25-30 °C (temperature of the resistor itself). ■ Equipped with a symmetrical 	

Thermofan

	Thermofan
	
	Terminal block
Cat. no.	NSYCRP1W230VTVC
Power rating (W)	400/550
Voltage (V)	230 AC
Characteristics	<ul style="list-style-type: none"> ■ Combination of a resistance heater and an axial motor to ensure uniform heating of the enclosure. ■ Fixing by clip on a DIN rail. ■ Thermostat adjustable from 0...+60 °C. ■ Visual operation indicator.

Ventilation accessories



Regulating

Others

Regulating

The thermostat can control the temperature inside electrical switchboards in conjunction with heating resistors and fans.

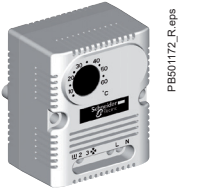
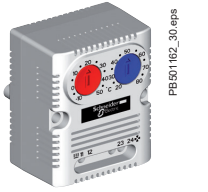
This thermostat can control the activation of a fan and a heater and regulate their temperature independently.

	Mechanical thermostats		Electronical thermostats		
					
	Thermostat with OF contact NSYCCOTHI	Double thermostat NSYCCOTHD	Electronical thermostat NSYCCOTH230VID	Electronic hygrotherm NSYCCOHYT230VID	Electronic hygrostat NSYCCOHY230VID
Cat. no.					
Colour of the button	Black	<ul style="list-style-type: none"> ■ Red: with normally closed contact (NC) for controlling the resistance heaters. ■ Blue: with normally open contact (NO) for controlling the fans, signalling systems or alarms. 	-	-	-
Contact	Inverse, forced rupture	1 with normally closed contact (NC), 1 with normally open contact (NO), forced rupture	Free with zero potential		
Internal sensor element	Bimetal		Internal temperature sensor	-	Internal humidity sensor
Switching capacity	250 V AC ; 10 A (resistive load)	250 V AC ; 10 A 120 V AC ; 15 A 250 V AC/120 V AC : 2 A (inductive load cos Ø= 0,6) 30 W DC	-	-	-
Max interrupting capacity with direct current	250 V AC 4 A (charge inductive Ø = 0,6) 30 W DC	-	-	-	-
Connection	Four 2.5 mm ² terminals	Six 2.5 mm ² terminals	2 x 2.5 mm ² (input voltage) + 2 relays (2 x 2.5 mm ² + 2 x 2.5 mm ²)	2 x 2.5 mm ² (input voltage) + 2 relays (2 x 2.5 mm ² + 2 x 2.5 mm ²)	2 x 2.5 mm ² (input voltage) + 1 relay (2 x 2.5 mm ²)
Dimensions (mm)	67 x 50 x 44	60 x 33 x 43	-	-	-
Weight (g)	100	40	-	-	-
Hysteresis	7° K	7° K	Programmed 2 °K	3 %	3 %
Temperature setting range	+5...+60 °C	0...+60 °C	-40 °C...+80 °C	-40 °C...+80 °C	-40 °C...+80 °C, humidity setting range:20 %...80 %
Characteristics	<ul style="list-style-type: none"> ■ Ingress protection rating: IP20. ■ Contact resistance: < 10 mΩ. ■ Service life: > 100 000 cycles. ■ Fixing: by clip on a 35-mm DIN rail ■ Case : plastic UL 94 V-0, light grey. ■ Operating temperature : -20...+80 °C (-4...+176 °F). ■ Display : °C/°F. ■ Max. command intensity: (NC) 5 A (NO) 10 A. 		<ul style="list-style-type: none"> ■ Ingress protection rating: IP20. ■ Certification : UL/UR. ■ Fixing: 4 different methods: on DIN rail, Spacial SF profile, on VDI cross-rail or on mounting plate ■ Boîtier : plastique UL 94 V-0, gris clair. ■ Operating temperature : -40 °C...+80 °C. ■ Display : °C/°F. ■ Max. command intensity: 8 (5) A 230 V AC / 5 A 30 V DC. 		

PTC external temperature sensor (double insulation)

	
Cat. no.	NSYCCASTE
Characteristics	<ul style="list-style-type: none"> ■ Sensor operation or reading range: -30 °C...+80 °C. ■ IP67. ■ Thermostat installation tips: the thermostat should be installed at the top of the enclosure (the hottest place). See the various operating modes of each thermostat to choose the one that best meets your needs. ■ Hygrostat installation tips: the hygrostat should be installed at the bottom of the enclosure. 60 % RH is the optimum value in the enclosure.

Thermal management of switchboards

> page C-9.

Lighting system

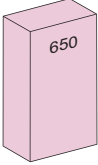
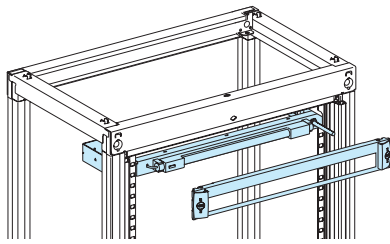
Fixed lighting	
	
Catalog number	LVS08964
Presentation	<p>This system is generally used to illuminate the front of a switchboard.</p> <ul style="list-style-type: none"> ■ The kit is made up of: <ul style="list-style-type: none"> □ a base □ a neon tube □ a front plate with cut-out (1 module) □ a door contact.
Characteristics	<ul style="list-style-type: none"> ■ Supply voltage: 220/240 V ■ Power rating: 8 W ■ Height: 1 vertical module (50 mm)

Switchboard portable lamp

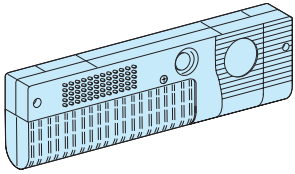
Switchboard portable lamp	
	
Catalog number	LVS08965
Presentation	<ul style="list-style-type: none"> ■ Lamp with a magnetic base for installation behind a door or directly on the cubicle framework. ■ Supplied without a power cord. ■ H x W x D: 90 x 345 x 42
Characteristics	<ul style="list-style-type: none"> ■ Supply voltage: 220/240 V ■ Power rating: 11 W ■ Lamp: picoline OSRAM 8W (supplied) ■ Class 2 ■ IP20

F

Linergy distribution systems

Contents

Power busbars

Linergy LGYE Horizontal profiles up to 4000 A	G-2
Linergy BS Horizontal busbars up to 4000 A	G-3
Linergy LGY Lateral profiles up to 3200 A	G-4
Linergy LGYE Lateral profiles up to 4000 A	G-5
Linergy BS Lateral flat busbars up to 4000 A	G-6
Linergy LGY Rear profiles up to 1600 A	G-7
Linergy BS Rear busbars up to 1600 A	G-8
Linergy BS Rear busbars up to 630 A	G-9
Multi-stage busbars up to 630 A	G-10
Multi-stage distribution block up to 630 A	G-11
Incomer accessories up to 630 A	G-12
Linergy Busbars Accessories	G-13

Distribution blocks

Linergy DP Quick distribution blocks - ComPacT NSX and INS-INV up to 250 A	G-14
Quick distribution blocks - ComPacT NSXm up to 160 A	G-15

Device feeders

Linergy FC Feeders for ComPacT NSX and INS-INV up to 250 A	G-16
Feeders for ComPacT NSXm up to 160 A	G-18

Secondary distribution

Insulated flexible bars	G-20
--------------------------------	-------------

Distribution blocks

Linergy DX Quick distribution blocks	G-22
--	------

Device feeders

Linergy FM Quick device feeders	G-24
---	------

Distribution blocks

Linergy DS Screw distribution blocks	G-26
--	------

Device feeders

Linergy FH Comb busbar for 27 mm pitch for C120, NG125	G-28
Comb busbar for 18 mm pitch for Acti 9	G-29
Comb busbar for 9 mm pitch for Acti 9, C60	G-31
Comb busbar for 9 mm pitch for Acti 9	G-32
Horizontal comb busbar for 18 mm pitch for Domae	G-33
Horizontal biconnect comb busbar for 18 mm pitch	G-34

Terminal blocks and lines

Linergy TA Auxiliary connections	G-35
Linergy TB Earth bars	G-36
PE conductor	G-37

Secondary distribution

Linergy TB terminal block support	G-38
--	-------------

Electrical characteristics

Designing connection ≤ 630 A Auxiliary connections	G-39
Linergy TR Terminal blocks	G-40

Linergy LGYE

Horizontal profiles up to 4000 A

400 mm deep installation

Power busbars

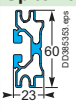
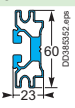
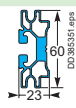
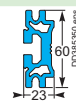
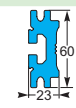
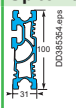
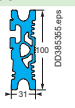
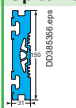
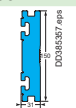
Linergy LGYE profiles										
Installation		Up to 1600 A					Up to 2500 A		Up to 4000 A	
Linergy profiles, 2000 mm length										
		630 A	800 A	1000 A	1250 A	1600 A	2000 A	2500 A	3200 A	4000 A
Permissible current for an ambient temperature of 35 °C around the switchboard		IP ≤ 31		630 A	800 A	1000 A	1250 A	1650 A	2000 A	2440 A
		IP > 31		530 A	680 A	850 A	1050 A	1480 A	1650 A	2100 A
Number of profiles per phase		1								
Total number of vertical modules (50 mm)		3					3		4	
Catalog numbers		LVS04560	LVS04561	LVS04562	LVS04563	LVS04564	LVS04565	LVS04566	LVS04567	LVS04568

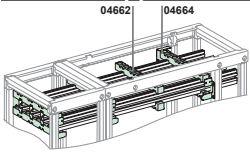
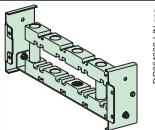
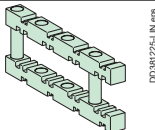
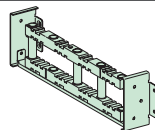
Busbar supports			
   			
		Fixed support LVS04664 Free support LVS04662 Fixed support LVS04665 Free support LVS04678	
Characteristics Two fixed supports for 650 mm or 650 + 150 mm wide PrismaSeT P Active frameworks and one fixed support for 300/400 mm wide PrismaSeT P Active frameworks are mandatory. If more supports are required, use free supports. Note: in case of 600 mm depth with 115 mm between centers, replace LVS04664 fixed support by LVS04665 and LVS04662 free support by LVS04678 .			
In cubicle W = 650 or W = 650+150 busbar supports 75 mm between centres	Number of supports	≤ 15 ≤ 25 depending on	2 2 2
	lcw (kA rms/1 s)	≤ 40 ≤ 50 ≤ 60 ≤ 65 ≤ 75 ≤ 85 ≤ 100	- - - - - - -
Catalog numbers		Fixed support Free support	LVS04664 LVS04662
			LVS04664 + LVS04671 (1) (hardware) LVS04662 + LVS04671 (1) (hardware)
			LVS04664 + LVS04646 (2) (hardware) LVS04662 + LVS04646 (2) (hardware)
In cubicle W = 800 busbar supports 75 mm between centres	Number of supports depending on lcw (kA rms/1 s)	≤ 100	2 + 4 (3)
	Catalog numbers	Fixed support Free support	LVS04664 LVS04662
			LVS04664 + LVS04671 (1) (hardware) LVS04662 + LVS04671 (1) (hardware)
			LVS04664 + LVS04646 (2) (hardware) LVS04662 + LVS04646 (2) (hardware)
In duct W = 300 busbar supports 75 mm between centres	Number of supports depending on lcw (kA rms/1 s)	≤ 60 ≤ 85 ≤ 100	1 1 + 1 -
	Catalog numbers	Fixed support Free support	LVS04664 LVS04662
			LVS04664 + LVS04671 (1) (hardware) LVS04662 + LVS04671 (1) (hardware)
			LVS04664 + LVS04646 (2) (hardware) LVS04662 + LVS04646 (2) (hardware)
In duct W = 400 busbar supports 75 mm between centres	Number of supports depending on lcw (kA rms/1 s)	≤ 50 ≤ 85 ≤ 100	1 1 + 1 -
	Catalog numbers	Fixed support Free support	LVS04664 LVS04662
			LVS04664 + LVS04671 (1) (hardware) LVS04662 + LVS04671 (1) (hardware)
			LVS04664 + LVS04646 (2) (hardware) LVS04662 + LVS04646 (2) (hardware)

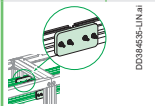
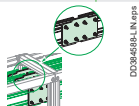
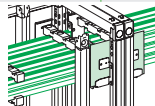
Joints										
		Up to 1600 A					Up to 2500 A		Up to 4000 A	
		630 A	800 A	1000 A	1250 A	1600 A	2000 A	2500 A	3200 A	4000 A
										
Catalog numbers		LVS04620		LVS04623		LVS04624				
		3 x LVS04620 (3P) 4 x LVS04620 + LVS04624 (4P)				3 x LVS04621 (3P) 4 x LVS04621 + LVS04624 (4P)		3 x LVS04623 (3P) 4 x LVS04623 + LVS04624 (4P)		
Note		LVS04624 is mandatory in case of jointed 4P Linergy LGYE busbars installations and must be installed only at the junction on side-by-side frameworks combination. When installed at the bottom of cubicles, the busbars must be partitioned.								

(1) LVS04671: mounting hardware for bars or profile H = 100 or 120 mm. Contains 2 threaded rods and 4 insulators.

(2) LVS04646: mounting hardware for bars or profile H = 150 mm. Contains 2 threaded rods and 2 insulators.

(3) It is applicable for W800 control panel configuration only.

Note: for accessories > page G-13.

Linergy BS

Horizontal busbars up to 4000 A

400 mm deep installation

Power busbars

Flat bars		Up to 1600 A				Up to 4000 A							
Installation													
Copper without holes, 2000 mm length													
Permissible current for an ambient temperature of 35 °C around the switchboard	IP ≤ 31	800 A	1000 A	1400 A	1800 A	1200 A	1400 A	1800 A	2050 A	2300 A	2820 A	3300 A	3760 A
	IP > 31	750 A	900 A	1250 A	1600 A	1080 A	1250 A	1600 A	1850 A	2000 A	2500 A	2900 A	3340 A
Size of bars (mm)		60 x 5	80 x 5	60 x 5	80 x 5	50 x 10	60 x 10	80 x 10	50 x 10	60 x 10	80 x 10	100 x 10	120 x 10
Number of bars per phase		1	1	2	2	1	1	1	2	2	2	2	2
Total number of vertical modules (50 mm)		3											4
Catalog numbers		LVS04536	LVS04538	LVS04536	LVS04538	LVS04545	LVS04546	LVS04548	LVS04545	LVS04546	LVS04548	LVS04550	LVS04552

Busbar supports					
Characteristics		Two fixed supports for 650 mm, 650 + 150 mm wide frameworks and one fixed support for 300/400 mm wide PrismaSeT P Active frameworks are mandatory. If more supports are required, use free supports. Note: in case of 600 mm depth with 115 mm between centers, replace LVS04664 fixed support by LVS04665 and LVS04662 free support by LVS04678.			
In cubicle W = 650 or W = 650+150 busbar supports 75 mm between centres	Number of supports depending on l _{cw} (kA rms/1 s)	≤ 15	2		
		≤ 25	2+1	2	
	≤ 30	≤ 30	2+1	2	
		≤ 40	2+1		
	≤ 50	≤ 50	-	2+1	2
		≤ 60	-	2+1	
	≤ 65	≤ 65	-	2+1	
		≤ 75	-	2+2	2+1
	≤ 85	-	-	2+1	
	Catalog numbers	Fixed support	LVS04664	LVS04664	LVS04664 + LVS04671 (1) (hardware)
Free support		LVS04662	LVS04662	LVS04662 + LVS04671 (1) (hardware)	
In cubicle W = 800 busbar supports 75 mm between centres	Number of supports depending on l _{cw} (kA rms/1 s)	≤ 100	2 + 4 (2)		
		Catalog numbers	Fixed support	LVS04664	LVS04664 + LVS04671 (1) (hardware)
	Free support		LVS04662	LVS04662 + LVS04671 (1) (hardware)	LVS04662 + LVS04646 (2) (hardware)
	In duct W = 300 busbar supports 75 mm between centres	Number of supports depending on l _{cw} (kA rms/1 s)	≤ 30	1	
≤ 50			1 + 1	1	
≤ 85		≤ 85	-	1 + 1	
		Catalog numbers	Fixed support	LVS04664	LVS04664
Free support	LVS04662		LVS04662	LVS04662 + LVS04671 (1) (hardware)	
In duct W = 400 busbar supports 75 mm between centres	Number of supports depending on l _{cw} (kA rms/1 s)	≤ 25	1		
		≤ 40	1 + 1	1	
	≤ 50	≤ 50	1 + 1		
		≤ 85	-	1 + 1	
Catalog numbers	Fixed support	LVS04664	LVS04664	LVS04664 + LVS04671 (1) (hardware)	
	Free support	LVS04662	LVS04662	LVS04662 + LVS04671 (1) (hardware)	



Joints		Up to 1600 A				Up to 4000 A					
Installation		1 bar per phase		2 bars per phase		1 bar per phase		2 bars per phase			
Size of bars (mm)		60 x 5	80 x 5	60 x 5	80 x 5	80 x 10	50 x 10	60 x 10	80 x 10	100 x 10	120 x 10
Sliding joints with torque nut											
Catalog numbers (1 joint per phase)		LVS04640	LVS04641	LVS04640	LVS04641	LVS04641	LVS04640	LVS04640	LVS04641	LVS04641	LVS04643
Note		when installed at the bottom of cubicles, the busbars must be partitioned.									











(1) LVS04671: mounting hardware for bars or profile H = 100 or 120 mm. Contain 2 threaded rods and 4 insulators.
 (2) It is applicable for W800 control panel configuration only.

Linergy LGY

Lateral profiles up to 3200 A

400 mm deep installation

Power busbars

Linergy LGY profiles		Up to 1600 A (simple busbars)					Up to 3200 A (double busbars)				
In duct Linergy profiles, 1670 mm length		W150					2 x W150				
											
Permissible current for an ambient temperature of 35 °C around the switchboard	IP ≤ 31	630 A	800 A	1000 A	1250 A	1600 A	2 x 1000 A	2 x 1250 A	2 x 1600 A		
	IP > 31	680 A	840 A	1040 A	1290 A	1650 A	2000 A	2500 A	3200 A		
Number of profiles per phase		1					2				
Catalog numbers		LVS04502	LVS04503	LVS04504	LVS04505	LVS04506	LVS04504	LVS04505	LVS04506		

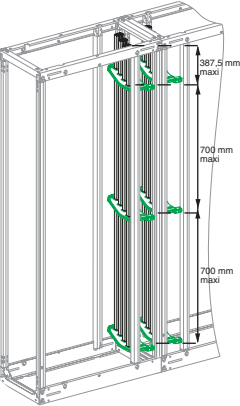
Busbar supports		Fixed support LVS04651		
 <p>Characteristics</p>		An end stop must be installed on the bottom support: LVS01109 (set of 12).		
	Number of supports depending on Icw (kA rms/1 s)	≤ 25	3	2 x 3
	≤ 30	-	3	2 x 3
	≤ 40	-	3	2 x 3
	≤ 50	-	4	2 x 3
	≤ 60	-	5	2 x 4
≤ 65	-	-	5	2 x 4
≤ 75	-	-	7	2 x 5
≤ 85	-	-	8	2 x 5
Catalog numbers	Fixed support	LVS04651		
	Chock	LVS01109		

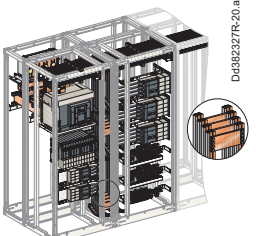
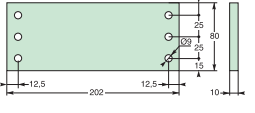
Equipotential links		3 equipments must be installed between the busbars.	
			 <p>Connection made with a flat 80 x 10 mm busbar between 2 W150 ducts</p>
	Catalog numbers	LVS01109	

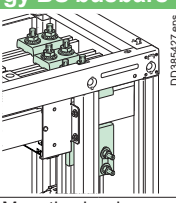
Connections to the horizontal Linergy BS busbars		Mounting hardware supplied. Order 1 link per phase	
	Cat. no.	Thickness 5 mm	LVS04634 (1000 A) LVS04635 (1600 A)
	according to horizontal busbar size	Thickness W ≤ 80 mm	LVS04636
		10 mm W 100 mm	LVS04636 + LVS04642 (2)
		W 120 mm	LVS04638
			2 x LVS04636
			2 x LVS04636 + 2 x LVS04642
			2 x LVS04638

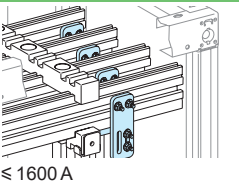
Connections to the horizontal Linergy LGE busbars		Supplied with mounting hardware. Catalog numbers include 1 connection only: 1 connection per phase.	
	Cat. no. according to horizontal busbar size	≤ 1600 A	LVS04602 (vertical connection)
			LVS04603 (vertical shifted connection) (1)



(1) Dedicated connection LVS04603 for Linergy LGE busbar in 150 mm duct with horizontal jointing
 (2) LVS04642: mounting hardware for bars > 80 mm. Comprises 2 threaded rods.

Linergy LGYE

Lateral profiles up to 4000 A

400 mm deep installation

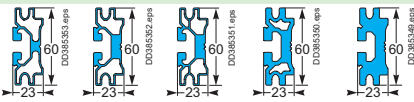
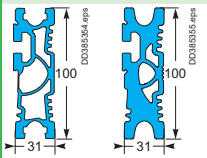
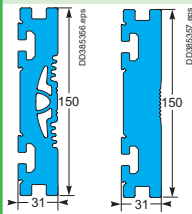
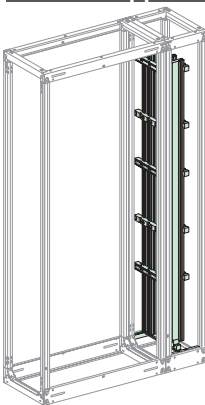
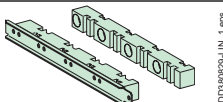
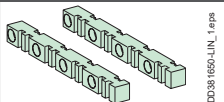
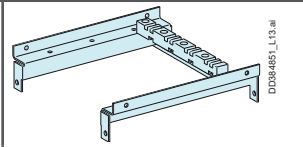
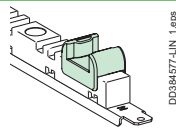
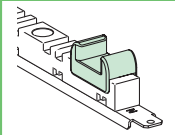
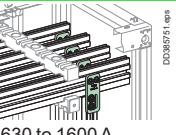
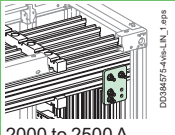
Power busbars

Linergy LGYE profiles										
		Linergy profile, 2000 mm length (1)					Linergy profile, 1625 mm length			
In duct	W150					W150	W300			
Linergy profile										
Permissible current for an ambient temperature of 35 °C around the switchboard	IP ≤ 31	630 A	800 A	1000 A	1250 A	1600 A	2000 A	2500 A	3200 A	4000 A
	IP > 31	630 A	800 A	1000 A	1250 A	1650 A	2000 A	2440 A	3200 A	3620
Length to cut for side mounting		1675 mm					-	-		
Number of profiles per phase		1								
Catalog numbers		LVS04560	LVS04561	LVS04562	LVS04563	LVS04564	LVS04507	LVS04508	LVS04509	LVS04510
Busbar supports										
										
	Characteristics	<p>Attach directly to the framework. Three fixed supports are required to maintain the busbars. If more than three supports are required, use additional free supports. The bottom support maintains the bars in position. It is not considered a busbar support. Note: in case of 600 mm depth with 115 mm between centers, replace LVS04661 fixed support by LVS04668, free support LVS04662 by LVS04678 and bottom support LVS04663 or LVS04666 by LVS04673.</p>								
Number depending on l _{cw} (kA rms/1 s)	≤ 30	3		3+2		3				
	≤ 40	-		3+2		3				
	≤ 50	-		3+2		3				
	≤ 60	-		3+2		3				
	≤ 65	-		3+2		3				
	≤ 75	-		3+4		3+2				
	≤ 85	-		3+4		3+2				
	≤ 100	-		3+6		3+6				
In duct W150, W = 300 busbar supports 75 mm between centres	Catalog numbers	Fixed support	LVS04661				LVS04661 + LVS04671 (2)		LVS04661 + LVS04646 (3)	
		Free support	LVS04662				LVS04662 + LVS04671 (2)		LVS04662 + LVS04646 (3)	
Busbars chocks										
										
Characteristics		Chocks installed on a bottom support LVS04658				Chocks installed on a bottom support LVS04659				
		The bottom support maintains the sections in position. It is not considered a busbar support.								
In duct W150, W = 300	Catalog numbers	Bottom support	LVS04663				LVS04666 + LVS04661			
		Chocks	LVS04658				LVS04659			
Connections to the horizontal Linergy LGYE busbars										
										
Characteristics		630 to 1600 A				2000 to 2500 A		3200 to 4000 A		
		Supplied with mounting hardware. Catalog numbers include 1 connection only: 1 connection per phase.								
Cat. no. according to horizontal busbar size		LVS04602 (straight connection) LVS04603 (shifted connection)				LVS04604 (short connection) LVS04605 (long connection)		LVS04607		

- (1) Linergy LGYE profiles up to 1600 A must be cut at the dimension of the cubicle : 1625 mm
- (2) LVS04671: mounting hardware for bars or profile H = 100 or 120 mm. Containt 2 threaded rods and 4 insulators.
- (3) LVS04646: mounting hardware for bars or profile H = 150 mm. Containt 2 threaded rods and 3 insulators

Linergy LGY

Rear profiles up to 1600 A

Power busbars

Linergy LGY profiles		Up to 1600 A				
At the rear of the cubicle		W650				
Linergy profile, 1670 mm length						
		630 A	800 A	1000 A	1250 A	1600 A
Permissible current for an ambient temperature of 35 °C around the switchboard	IP ≤ 31	680 A	840 A	1040 A	1290 A	1650 A
	IP > 31	590 A	760 A	950 A	1170 A	1480 A
Number of profiles per phase		1				
Catalog numbers		LVS04502	LVS04503	LVS04504	LVS04505	LVS04506

Busbar supports		Fixed support LVS04652				
	Number of supports	≤ 25	3			
	depending on I _{cw} (kA rms/1 s)	≤ 30	-		4	
		≤ 40	-		5	
		≤ 50	-		7	
Characteristics				Stop to be installed on the bottom support. LVS01109 (set of 12).		
Catalog numbers		Fixed support	LVS04652			
		Chock	LVS01109			

Connections to the horizontal Linergy BS flat busbars		Connection LVS04635 to horizontal busbars 5 mm thick.		Connection LVS04636 to horizontal busbars 10 mm thick.	
Characteristics		Mounting hardware supplied, order 1 connection per phase. For part of the connection, flexible insulated busbars are needed.			
Cat. no. according to horizontal busbar size	Thickness 5 mm	LVS04635			
	Thickness 10 mm	W ≤ 80 mm	LVS04636		
		W > 80 mm	LVS04636 + LVS04642		

Connections to the horizontal Linergy LGYE flat busbars		Connection LVS04602 to horizontal Linergy LGYE busbars 5 mm thick.	
Characteristics		Mounting hardware supplied, order 1 connection per phase. For part of the connection, flexible insulated busbars are needed.	
Catalog numbers		LVS04602	

Linergy BS

Rear busbars up to 1600 A

Power busbars

Flat bars

		Up to 1600 A						
At the rear of the cubicle		L650						
Copper with holes, 1670 mm length								
Permissible current for an ambient temperature of 35 °C around the switchboard	IP ≤ 31	800 A	1000 A	1400 A	1800 A	1000 A	1200 A	1600 A
	IP > 31	750 A	900 A	1250 A	1600 A	1080 A	1250 A	1600 A
Size of bars (mm)		60 x 5	80 x 5	60 x 5	80 x 5	50 x 10	60 x 10	80 x 10
Number of bars per phase		1			2		1	
Catalog numbers		LVS04516	LVS04518	LVS04516	LVS04518	LVS04525	LVS04526	LVS04528

Busbar supports

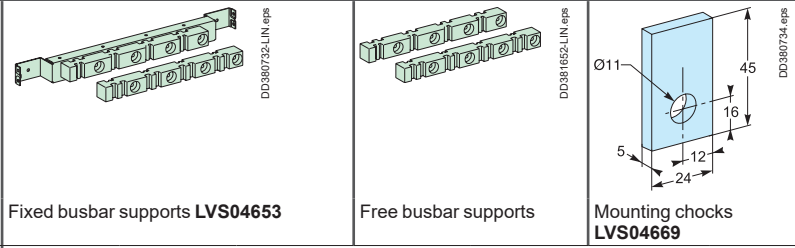

Characteristics
 Three fixed supports cat. no. LVS04653 are required to maintain the busbars.
 If more than three supports are required, use additional free supports cat. no. LVS04662.
 A metal mounting chock, cat. no. LVS04669 (set of 100) 5 mm thick, is screwed to the bar. It rests on a fixed support and maintains the position of the bar.

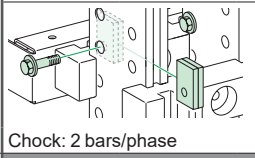
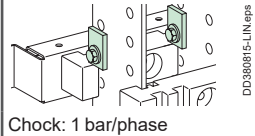
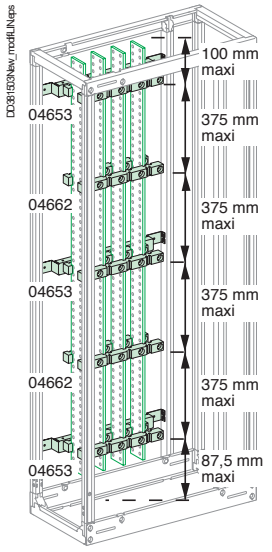

Number of supports depending on Icw (kA rms/1 s)	≤ 15	≤ 25	≤ 30	≤ 40	≤ 50	≤ 60	≤ 65	≤ 75	≤ 85
3	3	3	3	3	3	3	3	3	3
3+2	3+2	3	3	3+2	3+2	3+4	3+4	-	3+6
3+4	3+4	3+2	3+2	3+2	3+2	3+4	3+4	-	3+6
-	-	3+4	-	-	-	-	-	-	-

Catalog numbers LVS04653 (fixed) + LVS04662 (free) + LVS04669 (chock)

Connections to the horizontal Linergy BS flat busbars

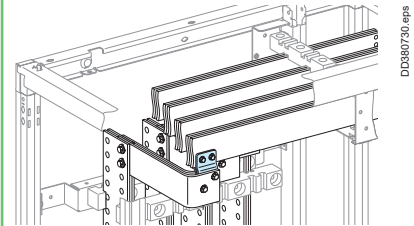

Connection LVS04636 to horizontal busbars
 Thickness 5 mm

Connection LVS04636 to horizontal busbars
 Thickness 10 mm

Characteristics
 For part of the connection, flexible insulated busbars are needed.
 Catalog numbers LVS04635 and LVS04636 include 1 connection only = 1 connection per phase.
 Reference LVS04642 consists of 2 M8 x 140 screws which can replace the original M8 x 120 screws.

Cat. no. according to busbar size	Thickness 5 mm	Thickness W ≤ 80 mm	Thickness W > 80 mm
	LVS04635	LVS04636 (1)	LVS04636 + LVS04642 (1)

(1) To be made.

Linergy BS

Rear busbars up to 630 A

Power busbars

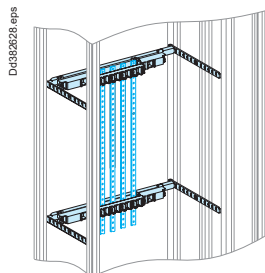

IEC 61439-1 & 2

Description

The busbar can be 3-pole or 4-pole with ratings between 160 A and 630 A. 2 lengths are available: 1000 and 1400 mm, which can be cut as required. The number of supports depends on the installation maximum rated current. The insulating supports can receive a fifth bar, 15 x 5 mm or 20 x 5 mm, to create an earth bar.

160 to 400 A copper busbars

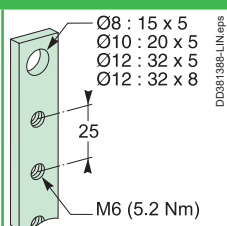

	160 A	250 A	400 A	630 A			
Rated peak withstand current (I _{pk})	30 kÅ	40 kÅ	55 kÅ	77 kÅ			
Rated insulation voltage (U _i)	1000 V AC	1000 V AC	1000 V AC	1000 V AC			
Rated short-time current (I _{cc})	150 kA	150 kA	150 kA	150 kA			
Thermal stress (I ² .t)	1.000 x 10 ⁸	2.250 x 10 ⁸	6.250 x 10 ⁸	1.225 x 10 ⁹			
Conductor cross-section	15 x 5 mm	20 x 5 mm	32 x 5 mm	32 x 8 mm			
Installation	Threaded M6 holes every 25 mm all the way up Connection by: 16 to 50 mm ² flexible cables with crimped lugs						
Set of	4						
Length (mm)	1000	1400	1000	1400	1000	1400	1400
Catalog numbers	LVS04161	LVS04171	LVS04162	LVS04172	LVS04163	LVS04173	LVS04174

Insulating busbar support

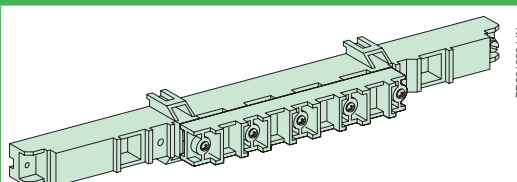

Distance between supports depending on I _{cw} /I _{pk} (1)	≤ 10 kA eff / 1 s	≤ 13 kA eff / 1 s	≤ 15 kA eff / 1 s	≤ 20 kA eff / 1 s	≤ 25 kA eff / 1 s	≤ 30 kA eff / 1 s	≤ 35 kA eff / 1 s
	450 mm	450 mm	450 mm	450 mm	450 mm	450 mm	450 mm
	-	450 mm	450 mm	450 mm	450 mm	450 mm	450 mm
	-	450 mm	450 mm	450 mm	450 mm	450 mm	450 mm
	-	-	-	300 mm	300 mm	300 mm	300 mm
	-	-	-	225 mm	225 mm	225 mm	225 mm
	-	-	-	-	-	225 mm	225 mm
	-	-	-	-	-	-	175 mm
Installation	On the rear uprights Screwed onto a solid or pre-slotted plate (fixing centres 450 x 200 mm)						
Catalog numbers	LVS04191	LVS04191	LVS04191	LVS04191	LVS04191	LVS04191	LG4193

IPxxB insulating protective shield

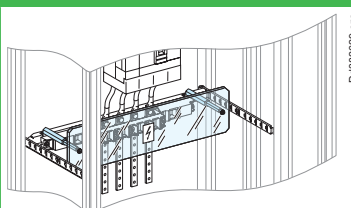

Length	470 mm
Height	100 mm
Composition	Supplied with fixings.
Catalog numbers	LVS04198

Note: electrical characteristics > page G-39.

(1) Linergy FM 200 A distribution blocks with connections ref. LVS04029 can act as intermediate supports (max. distance apart 200 mm) in addition to the support ref. LVS04191 at the top and bottom.

Version : 14 - 15/12/2023
 160E7100

Linergy BS

Multi-stage busbars up to 630 A

Power busbars

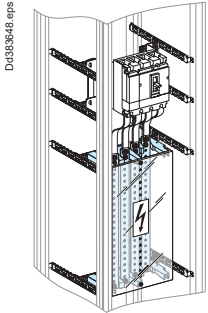

IEC 61439-1 & 2

Description

Multi-stage busbars are installed in a sheath W = 400 mm.

We strongly recommend dividing the current between 2 cubicles or enclosures joined on either sides.

All the connection points are easily accessible from the front.

The busbar orientation makes them easier to tighten and facilitates running the cables between them.

The current can be 3-pole or 4-pole with ratings between 160 A and 630 A.

2 lengths are available: 1000 and 1400 mm, which can be cut as required.

The number of supports depends on the installation maximum rated current.

160 to 630 A copper busbars

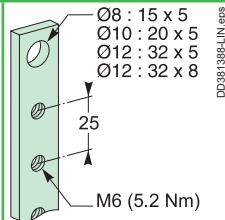

	160 A	250 A	400 A	630 A				
Rated peak withstand current (I _{pk})	30 kÅ	40 kÅ	55 kÅ	55 kÅ				
Rated insulation voltage (U _i)	750 V AC	750 V AC	750 V AC	750 V AC				
Rated short-time current (I _{cc})	150 kA	150 kA	150 kA	150 kA				
Thermal stress (I ² .t)	1.000 x 10 ⁸	1.690 x 10 ⁸	4.000 x 10 ⁸	6.250 x 10 ⁸				
Rated short-time withstand current (I _{cw})	10 kA rms/1 second	13 kA rms/1 second	15/20/25 kA rms/1 second	35 kA rms/1 second				
Supply at incoming terminals	Connection by: 16 to 50 mm ² flexible cables with crimped lugs.							
Conductor cross-section	15 x 5 mm	20 x 5 mm	32 x 5 mm	32 x 8 mm				
Installation	Flat copper busbar with threaded M6 holes every 25 mm all the way up.							
Set of	4							
Width (mm)	1000	1400	1000	1400	1000	1400	1000	1400
Catalog numbers	LVS04161	LVS04171	LVS04162	LVS04172	LVS04163	LVS04173	To be made	LVS04174

Insulating busbar support

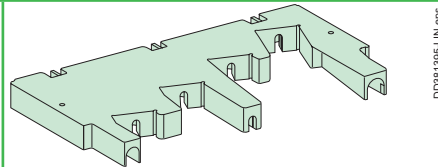

Distance between supports depending on I _{cw} /I _{pk}	≤ 10 kA rms/ 1 s / 30 kÅ	≤ 13 kA rms/ 1 s / 40 kÅ	≤ 15 kA rms/ 1 s / 40 kÅ	≤ 20 kA rms/ 1 s / 45 kÅ	≤ 25 kA rms/ 0,6 s / 55 kÅ	≤ 25 kA rms/ 1 s / 55 kÅ
450 mm	450 mm	450 mm	450 mm	450 mm	450 mm	450 mm
-	450 mm	450 mm	450 mm	450 mm	450 mm	450 mm
-	-	-	300 mm	300 mm	300 mm	300 mm
-	-	-	300 mm	-	-	-
-	-	-	-	-	-	300 mm

Installation: Installation on functional uprights of duct (PrismaSeT).
Screwed onto a solid or pre-slotted plate (450 x 200 mm fixing centres)

Catalog numbers	LVS04192	LVS04192	LVS04192	LVS04192
-----------------	----------	----------	----------	----------

IPxxB insulating protective shield

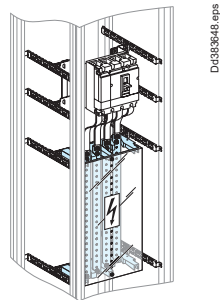

Width	250 mm
Height	1500 mm
Composition	Fixing accessories supplied with support cat. no. LVS04192.
Catalog numbers	LVS04197

Note: electrical characteristics > page G-39.

Linergy BS

Multi-stage distribution block up to 630 A

Power busbars

PE602514_00.eps

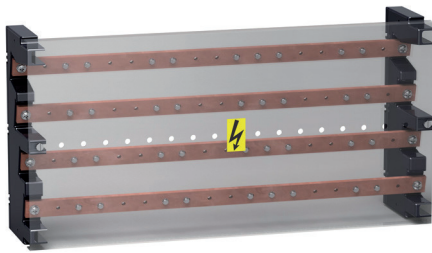

IEC 61439-1 & 2

Description

The distribution block can be installed horizontally in the device zone or vertically in the 300 mm wide duct of enclosures and cubicles.

The distribution block is made up of:

- two staggered supports made of an insulating material
- four slanted copper bars with holes every 25 mm.

Multi-stage distribution block

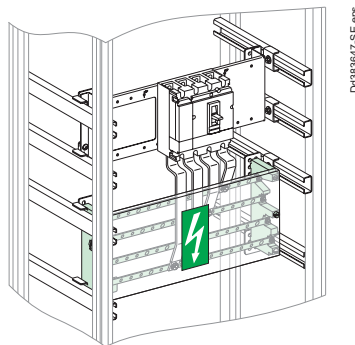

D0383677-SE.eps

		160 A	250 A	400 A	630 A
Rated peak withstand current	(Ipk)	30 kÅ	40 kÅ	55 kÅ	55 kÅ
Rated insulation voltage	(Ui)	750 V AC			
Rated operational voltage	(Ue)	440 V AC			
Rated impulse withstand voltage	(Uimp)	8 kV			
Rated short-time current	(Icc)	150 kA	150 kA	150 kA	150 kA
Thermal stress	(I ² .t)	1.000 x 10 ⁸	1.690 x 10 ⁸	4.000 x 10 ⁸	6.250 x 10 ⁸
Total connection capacity		4 incomers per phase: Ø12.2 mm clearance holes 13 outgoing per phase 16 to 50 mm ² : M6 tapped holes			
Busbar cross-section		15 x 5 mm	20 x 5 mm	32 x 5 mm	32 x 8 mm

Dimensions (mm)

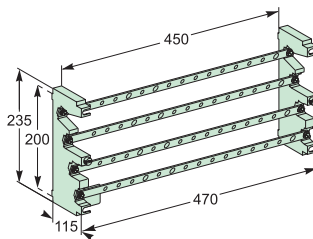

D0381344-LIN-40.eps

Installation	Screwed onto a solid or pre-slotted plate (fixing centres 450 x 200 mm) Screwed to an adapter cat. no. LVS03595 .
Composition	2 multi-stage supports made of an insulating material 4 slanted copper busbars, with holes every 25 mm 1 pack of 36 M6 x 16 screws + contact washers 1 IPxxB front insulating shield
Catalog numbers	LVS04052 LVS04053 LVS04054 LVS04055



Linergy BS

Incomer accessories up to 630 A

Power busbars

Incomer accessories

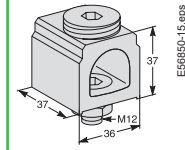
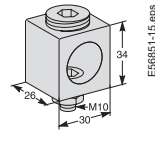
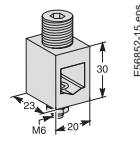

Connectors for copper or aluminium cables			
Rated operational current at 40 °C (Ie)	160 A	250 A	400 A
Supply at incoming terminals	70 mm ² Cables	16 - 185 mm ² Cables	70 - 300 mm ² Cables
Composition	Supplied with fixings at busbar end.		
Set of	4		
Catalog numbers	LVS07051	LVS07052	LVS07053

Outgoer accessories

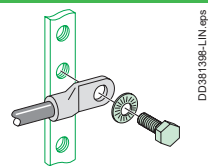



Class 8.8 fixing accessories		
Composition	20 M6 x 20 screws + 20 nuts + 40 contact washers	40 M6 x 16 screws + 40 contact washers
Catalog numbers	LVS04194	LVS04195

Note: electrical characteristics > page G-39.

Linergy Busbars

Accessories

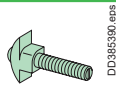
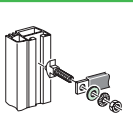
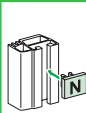
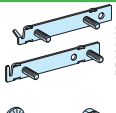
Power busbars

Accessories											
	 DD385391.eps		 DD381219-LIN-16.eps			 DD381222-LIN-10.eps		 DD385458.eps		 DD385391.eps	
	Linergy connection hardware		Steel flat washers			Brass flat washers		Markers		Screwplate	
Cat. no.	LVS04766	LVS04767	LVS04772	LVS04773	LVS04774	LVS04775	LVS04794	LVS01130	LVS04768	LVS04769	
Characteristics	L 25 mm	L 39 mm	20 mm ext. Ø	24 mm ext. Ø	28 mm ext. Ø	20 mm ext. Ø		2 studs	2 studs	3 studs	
	Set of 20: 20 bolts + 20 nuts + 20 contact washers, class 8.8. The screws slide into the profile and are then locked in the desired position.		M8 set of 20			M8 sold in lots of 20 for connection of ≤ 25 mm ² lugs to Linergy		12 clip-on supports + N, L1, L2, L3, PE, PEN labels		Linergy LGYE busbars connection kit spare part	
								Set of 12 flat plates with 2 studs + 24 torque nuts + 24 contact washers. The plates slide along the profile.		Set of 8 flat plates with 3 studs + 24 torque nuts + 24 contact washers. The plates slide along the profile.	

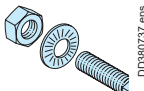
M8 bolts		
	 DD380737.eps	
Linergy BS, 20 bolts class 8.8	Characteristics	Set of 20 bolts + 20 nuts + 40 contact washers.
	Catalog numbers	LVS04782
	M8 x 20	LVS04783
	M8 x 25	LVS04784
	M8 x 30	LVS04785
	M8 x 35	LVS04786
	M8 x 40	LVS04787
	M8 x 45	LVS04788
	M8 x 50	LVS04788

Torque nuts		
	 DD380725.eps	
20 M8 torque nuts	Characteristics	Can be used to obtain the correct tightening torque (28 Nm) recommended by the manufacturer, without using a torque wrench. Torque nuts may be used for all electrical connections.
	Catalog numbers	LVS04759

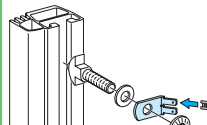
Voltage tap-offs		
	 DD380736.eps	
20 Voltage tap-offs M10 pour 2 clips 6.35	Characteristics	For small lugs (on low-current cables or measurement tap-offs), insert a conducting washer (cat. no. LVS04775) between the busbar and the lug.
	Catalog numbers	LVS04229



★ Connections on Linergy LGYE & LGY

InA (A)		Connecting to Linergy LGYE	Connecting to Linergy LGY
0 to 630	Cable - Insulated flexible bars	25 mm Linergy connection hardware used	25 mm Linergy connection hardware used
800 to 1250	5 mm bars	25 mm Linergy connection hardware used	25 mm Linergy connection hardware used
1600 to 2500	5 mm or 10 mm bars	Use of the 2 studs flat plate	39 mm Linergy connection hardware used
3200 to 4000	10 mm bars	Use of the 3 studs flat plate	-

Note: Jointing between 2 busbars (horizontal/vertical or horizontal/horizontal) must be mandatory done with studs plates.

Linergy DP

Quick distribution blocks - ComPacT NSX and INS-INV up to 250 A

Distribution blocks

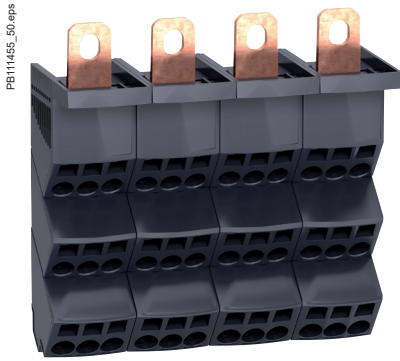



IEC 60947-7-1, IEC 61439-1 and 2

Description

■ The Linergy DP quick distribution block is designed for installation directly downstream of ComPacT NSX and INS-INV up to 250 A. It can also be clipped onto a modular rail.

Advantages

- It is quick to mount in the horizontal position. Electrical connections are made directly to the device terminals.
- It is the same width as the devices and does not take up any additional space in the switchboard.
- The connection terminals are slanted to facilitate cable entry and avoid exceeding the bending radius of the flexible and rigid cables.

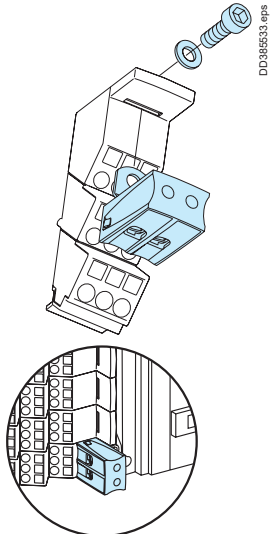
Quick distribution blocks for ComPacT devices			Additional block	
Number of poles	3P	4P	3P/4P	
				
Rated operational current (Ie)	250 A	250 A	250 A	
Rated peak withstand current (Ipk)	30 kA	30 kA	30 kA	
Rated short-time current (Icw)	8.5 kA rms/1 s	8.5 kA rms/1 s		
Thermal stress (I ² .t)	7.225 x 10 ⁷	7.225 x 10 ⁷		
Total connection capacity, outgoing terminals	27 connections: 6 x 10 ² /phase 3 x 16 ² /phase	36 connections: 6 x 10 ² /phase 3 x 16 ² /phase	2 connections: 2 x 35 ² /pole	
Incomer terminals	1 cable lug 120 mm ² per pole			
Dimensions (H x W x D)	105 x 138 x 63	140 x 138 x 64		
Installation	On mounting plate or DIN rail		On mounting plate	
Product certifications	ASEFA			
Standard for installation inside PrismaSeT	IEC 61439-1-2			
Glow-wire 60695-2-11	960 °C			
Catalog numbers	LVS04033	LVS04034	LVS04155 (3P) LVS04156 (4P)	

Technical Data	
Common characteristics	
Rated conditional short-circuit current of an assembly (Isc)	The reinforced breaking capacity due to cascading in circuit-breaker combinations is maintained. The worst-case situations have been tested.
Rated insulation voltage (Ui)	750 V AC
Rated operational voltage (Ue)	690 V AC
Rated impulse withstand voltage (Uimp)	8 kV
Network frequency	50/60 Hz
Degree of protection	IPxxB
Degree of pollution	3
Overvoltage category	III
Additional technical characteristics	
Reference temperature	40 °C
Operating temperature	-25 °C to 55 °C

Installation

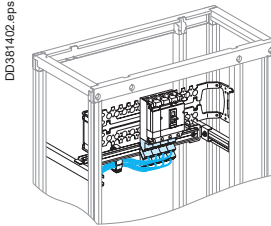
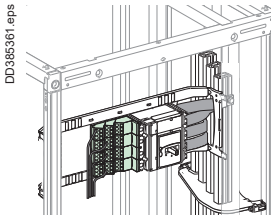
It can also be mounted downstream of vertically mounted **ComPacT NSX100/250** and **ComPacT INS-INV250** devices in the enclosures. In this case, the Linergy DP is mounted on a depth-adjustable modular rail.

Directly on the mounting plates of horizontally mounted **ComPacT NSX100/250** and **ComPacT INS-INV250** devices in the enclosures.

For details on mounting plates, refer [pages E-20, E-21, E-22, E-23, and E-24](#).

Note: Electrical characteristics > [page G-39](#).

Linergy DP

Quick distribution blocks - ComPacT NSXm up to 160 A

Distribution blocks

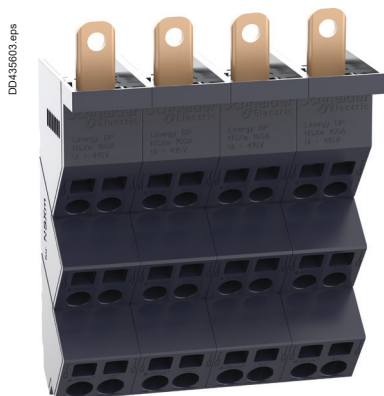

IEC 60947-7-1, IEC 61439-1 and 2

Description

■ The Linergy DP quick distribution block is designed for installation directly downstream of ComPacT NSXm up to 160 A. It can also be clipped onto a modular rail.

Advantages

- It is quick to mount in the horizontal position. Electrical connections are made directly to the device terminals.
- It is the same width as the devices and does not take up any additional space in the switchboard.
- The connection terminals are slanted to facilitate cable entry and avoid exceeding the bending radius of the flexible and rigid cables.

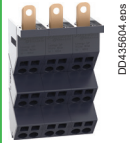
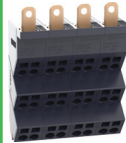
Quick distribution blocks for ComPacT devices			
Number of poles		3P	4P
			
Rated operational current	(Ie)	160 A	160 A
Rated peak withstand current	(Ipk)	20 kA	20 kA
Rated short-time current	(Icc)	70 kA	70 kA
Thermal stress	(I².t)	4.7 x 10⁶ A²S	4.7 x 10⁶ A²S
Total connection capacity, outgoing terminals		18 connections: 4 x 10²/phase 2 x 16²/phase	24 connections: 4 x 10²/phase 2 x 16²/phase
Incomer terminals		1 cable lug 70 mm² per pole	
Dimensions (H x W x D)		140 X 81 X 58 mm	140 X 108 X 58 mm
Installation		On mounting plate or DIN rail	
Product certifications		ASEFA	
Standard for installation inside PrismaSeT		IEC 61439-1-2	
Glow-wire 60695-2-11		960 °C	
Catalog numbers		LVS04038	LVS04039

Technical Data		
Common characteristics		
Rated conditional short-circuit current of an assembly	(Isc)	The reinforced breaking capacity due to cascading in circuit-breaker combinations is maintained. The worst-case situations have been tested.
Rated insulation voltage	(Ui)	800 V AC
Rated operational voltage	(Ue)	690 V AC
Rated impulse withstand voltage	(Uimp)	8 kV
Network frequency		50/60 Hz
Degree of protection		IPxxB
Degree of pollution		3
Overvoltage category		III
Additional technical characteristics		
Reference temperature		40 °C
Operating temperature		-25 °C to 55 °C

Installation

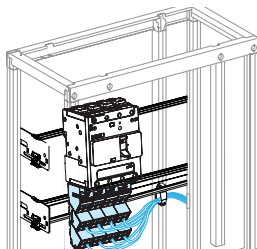

DD435606.eps

It can also be mounted downstream of vertically mounted **ComPacT NSXm** devices in the enclosures. In this case, the Linergy DP is mounted on a depth-adjustable modular rail.

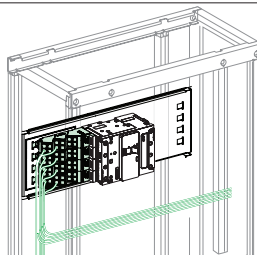

DD435607.eps

Directly on the mounting plates of horizontally mounted **ComPacT NSXm** devices in the enclosures.

For details on mounting plates, refer [page E-35](#).

Note: Electrical characteristics > page G-39.

Linergy FC

Feeders for ComPacT NSX and INS-INV up to 250 A

Device feeders

IEC 61439-1 and 2

Description

Linergy FC is an insulated horizontal distribution block. It connects directly to the mounting plate and can supply:

- Three 4P and four 3P ComPacT NSX circuit breakers, whatever the ratings (100, 160 or 250 A), the operating systems (toggle, rotary handle, motor mechanism), whether fixed or plug-in, front or rear connection (the circuit breakers must be equipped with long terminal shields downstream)
- Three 4P or four 3P ComPacT INS-INV switch-disconnectors, whatever the ratings (100, 160 or 250 A), whether front or rear connection.
- The design and small size blend thoroughly with the devices.
- It can be supplied by Linergy BS or Linergy LGY busbars positioned to the left or right.
- Fully insulated, Linergy FC helps to protect life and property. Numerous and well distributed vents ensure natural convection and optimum cooling of the conductors.
- The circuit breakers can be easily connected from the front. It is simple to interchange a device or to add a device in a reserve slot.
- There are markings (N, L1, L2, L3) on the front and the sides for the phases.
- The running of auxiliary cables between the devices and the corresponding terminal blocks is also taken into account. Spacious trunking is built into the blocks for the auxiliary wiring.

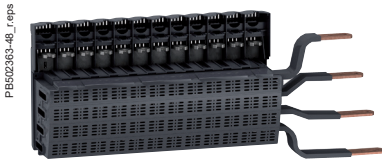

	ComPacT NSX100/250 & INS-INV250 - Toggle, fixed		ComPacT NSX100/250 - Rotary handle, motor mechanism - plug-in, fixed, ComPacT NSX100/250 - All controls, withdrawable		ComPacT NSX100/250 & INS-INV250 - All controls, fixed and withdrawable	
Number of poles	3P	4P	3P	4P	3P	4P
Connection to	Linergy LGY busbars		Linergy BS, Linergy LGY or Linergy LGYE busbars		Linergy BS, Linergy LGY or Linergy LGYE busbars	
Number of devices	4	3	4	3	4	3
Composition	Self-adhesive labels to mark the phases for connections to the busbars.					
Mounting plates						
Toggle, Fixed, NSX100/250	LVS03420	LVS03420	-	-	LVS03420	LVS03420
Toggle, Plug-in, NSX100/250	-	-	LVS03423	LVS03423	LVS03423	LVS03423
Rotary handle, motor mechanism - plug-in, Fixed, NSX100/250	-	-	LVS03422	LVS03422	LVS03422	LVS03422
Cat. no.	LVS04403	LVS04404	LVS04405	LVS04406	LVS04407 (2)	LVS04408 (2)

Implementation

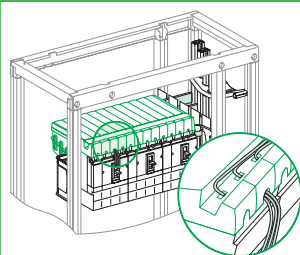

Auxiliary wires running in the built-in trunking.

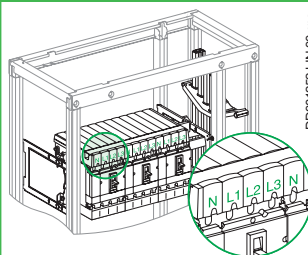

Phase marking on the front of the distribution block.

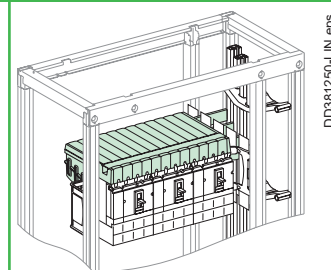



(1) The connection of a Linergy FC distribution block using pre-wired connectors or insulated flexible bars is not compatible with Form 2 partitioning (LVS04922). In this case, use the form 2 restoration kit (LVS04924).

(2) For the connection, use insulated flexible bars, 32 x 8 mm cat. no. LVS04753; Each connection must not be longer than 500 mm. This size is validated with Schneider Electric insulated flexible bars.

Linergy FC

Feeders for ComPacT NSX and INS-INV up to 250 A

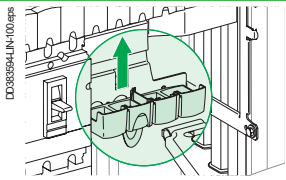
Device feeders

Accessories	
	
	<p>Tooth caps</p> <p>The caps block off the reserve terminals on a Linergy FC distribution block. Made of an insulating material, they simply clip on from the front.</p>
Catalog numbers	LVS04809

Characteristics

Common characteristics		
Rated operational current at 40°	(Ie)	Distribution-block derating follows the normal derating curves of ComPacT NSX and INS-INV
Rated conditional short-circuit current of an assembly	(Isc)	The reinforced breaking capacity due to cascading in circuit breaker combinations is maintained. The worst-case situations have been tested. The electrical characteristics are perfectly compatible with the connected devices. Neither the temperature derating curves nor the performance levels of the circuit breakers and switch-disconnectors are altered.
Rated insulation voltage	(Ui)	750 V AC
Rated operational voltage	(Ue)	690 V AC
Rated impulse withstand voltage	(Uimp)	8 kV
Rated peak withstand current	(Ipk)	50 kA rms
Rated short-time current with upstream protection of 85 kA Icc	(Icc)	85 kA
Thermal stress	(I².t)	2.500 x 10 ⁷
Rated conditional short-circuit current of an assembly		Short-circuit withstand current compatible with the breaking capacity of the ComPacT NSX circuit breakers connected to the distribution block.

Linergy FC selection table for special cases

For most installations, the temperature around the switchboard is 40 °C, corresponding to an average temperature of 60 °C inside the switchboard.

Under certain conditions, the temperature inside the switchboard may be different.

(A) Rated operational current as a function of the temperature inside the switchboard								
Temperature (°C)		40	45	50	55	60	65	70
I _{nc} (A)	3P	800	800	775	750	725	700	675
	4P	675	675	655	635	615	595	570

To obtain the maximum permissible current for the linergy FC, apply the diversity factor K:

- Linergy FC 3P: K = 0.8
- Linergy FC 4P: RDF = 0.9.



Linergy FC

Feeders for ComPacT NSXm up to 160 A

Device feeders

IEC 61439-1 and 2

Description

Linergy FC is an insulated horizontal distribution block. It connects directly to the mounting plate and can supply:

- Four 4P and five 3P ComPacT NSXm circuit breakers (four 3P and 4P for ComPacT NSXm Vigi), whatever the ratings (63, 100 or 160 A) with toggle and direct rotary handle operating mechanism.
- The design and small size blend thoroughly with the devices.
- It can be supplied by Linergy BS, Linergy LGYE and Linergy LGY busbars positioned to the left or right.
- Fully insulated, Linergy FC helps to protect life and property. Numerous and well distributed vents ensure natural convection and optimum cooling of the conductors.
- The circuit breakers can be easily connected from the front. It is simple to interchange a device or to add a device in a reserve slot.
- There are markings (N, L1, L2, L3) on the front and the sides for the phases.
- The running of auxiliary cables between the devices and the corresponding terminal blocks is also considered. Spacious trunking is built into the blocks for the auxiliary wiring.

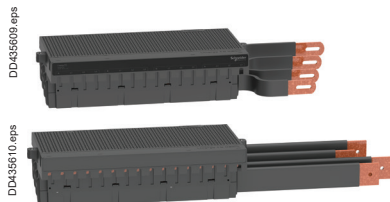

	ComPacT NSXm - Toggle (with Everlink terminal)		ComPacT NSXm - Toggle/ DRH (with Everlink terminal)			
	Linergy FC with prefabricated connections by insulated flexible bars (1)		Linergy FC with prefabricated connections (1)		Linergy FC without prefabricated connections (1)	
Number of poles	3P	4P	3P	4P	3P	4P
Connection to	Linergy LGY busbars		Linergy BS and Linergy LGYE busbars			
Number of devices	5 (2)	4	5 (2)	4	5 (2)	4
Mounting plates	LVS03416	LVS03416	LVS03416	LVS03416	LVS03416	LVS03416
Cat. no.	LVS04410	LVS04411	LVS04412	LVS04413	LVS04419 (3)	LVS04420 (3)
	LVS04416 (3)		LVS04417		LVS04418 (3) (4)	

Implementation

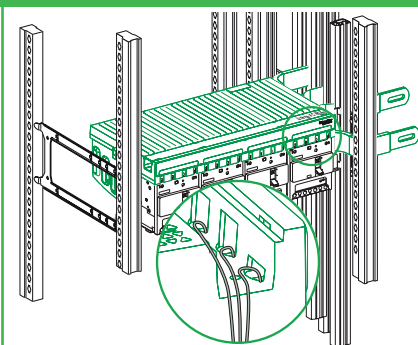

Auxiliary wires running in the built-in trunking.

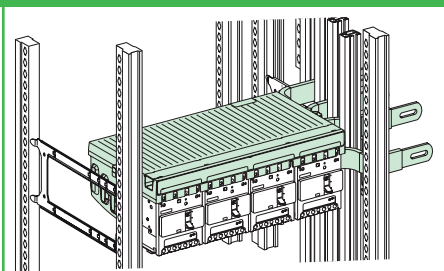

(1) The connection of a Linergy FC distribution block using pre-wired connectors or insulated flexible bars is not compatible with Form 2 partitioning (LVS04922). In this case, use the form 2 restoration kit (LVS04924).

(2) Linergy FC configuration having NSXm with Vigi can mount four devices in a row for both 3P and 4P.

(3) For the connection, use insulated flexible bars, 32 x 6 mm cat. no. LVS04752; Each connection must not be longer than 500 mm. This size is validated with Schneider Electric insulated flexible bars.

(4) The Catalog reference number is used only with NSXm Vigi.

Linergy FC

Feeders for ComPacT NSXm up to 160 A

Device feeders

Accessories

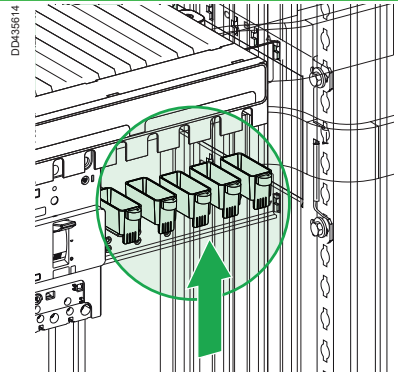

Catalog numbers

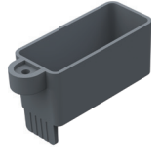

LVS04810

Tooth caps

The caps block off the reserve terminals on a Linergy FC distribution block. Made of an insulating material, they simply clip on and install the screw from the front.

Characteristics

Common characteristics		
Rated operational current at 40°	(Ie)	Distribution-block derating follows the normal derating curves of ComPacT NSXm
Rated conditional short-circuit current of an assembly	(Isc)	The reinforced breaking capacity due to cascading in circuit breaker combinations is maintained. The worst-case situations have been tested. The electrical characteristics are perfectly compatible with the connected devices. Neither the temperature derating curves nor the performance levels of the circuit breakers and switch-disconnectors are altered.
Rated insulation voltage	(Ui)	800 V AC
Rated operational voltage	(Ue)	690 V AC
Rated impulse withstand voltage	(Uimp)	8 kV
Rated peak withstand current	(Ipk)	18 kA
Rated short-time current with upstream protection of 85 kA Icc	(Icc)	50 kA
Thermal stress	(I².t)	4.5 x 10⁶ A²S
Rated conditional short-circuit current of an assembly		Short-circuit withstand current compatible with the breaking capacity of the ComPacT NSXm circuit breakers connected to the distribution block.

Linergy FC selection table for special cases

For most installations, the temperature around the switchboard is 40 °C, corresponding to an average temperature of 60 °C inside the switchboard.

Under certain conditions, the temperature inside the switchboard may be different.

(A) Rated operational current as a function of the temperature inside the switchboard					
Ambient Air Temperature outside panel (°C)		35	40	45	50
IP31 (A)	3P	600	575	550	525
	4P	500	480	460	440
IP55 (A)	3P	515	500	475	450
	4P	460	440	420	400



Insulated flexible bars

DD301059.eps

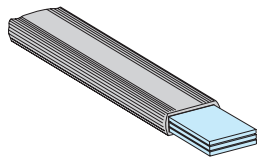

Secondary distribution

The insulated flexible bars are tested in a type-tested switchboard environment. Their design takes into account the switchboard architecture where they are often in close proximity to a protection device (circuit breaker or fuse) with significant heat losses.

The sizes for the flexible bars indicated below take into account the heat losses of Schneider Electric devices in a PrismaSeT switchboard.

Characteristics

Length	1800 mm
Rated insulation voltage (Ui)	1000 V
Maximum withstand temperature for the insulating material	125 °C

Connection between device and busbars

The flexible bars are determined taking into account the connected device, whatever the internal temperature of the switchboard.

The bar sizes indicated below take into account the derating curves of devices.

Devices	Size (mm)	Catalog number
NSX100	20 x 2	LVS04742
NSX160/250	20 x 3 (1)	LVS04743
NSX400	32 x 5	LVS04751
NSX630	32 x 8 (2)	LVS04753
NSX100 ELCB	20 x 2	LVS04742
NSX160/250 ELCB	20 x 3 (1)	LVS04743
NSX400 ELCB	32 x 5	LVS04751
NSX630 ELCB	32 x 8 (2)	LVS04753
INS-INV125/160	20 x 2	LVS04742
INS-INV250	20 x 3	LVS04743
INS-INV400	32 x 5	LVS04751
INS-INV630	32 x 6	LVS04752
FM 200 A Linergy	20 x 3	LVS04743
FC 3P Linergy	32 x 8 (2)(3)(4)	LVS04753
FC 4P Linergy	32 x 8 (2)(3)(4)	LVS04753
Fupact 250	24 x 5	LVS04746
Fupact 400	32 x 5	LVS04751
Fupact 630	32 x 8 (2)	LVS04753

(1) To connect a ComPacT NSX250 and NSX150 ELCB to Linergy BW busbars, use a 24 x 5 mm flexible bar (LVS04746).

(2) The insulated flexible bars is not compatible with Form 2 partitioning (LVS04922). In this case, use the form 2 restoration kit LVS04924 > page H-5.

(3) In case of use of 32 x 6 insulated flexible bar, please contact Schneider Electric.

(4) Max length 500 mm per connection

The references **87646** (3P) and **87647** (4P) can be used up to 250 A, when binding of insulated flexible bars, to withstand Icw.

Nota : For NSXm connection, there is no flat insulated flexible bar available. Choose a cable prefabricated connection > page E-35 and page E-36

DD065905.eps

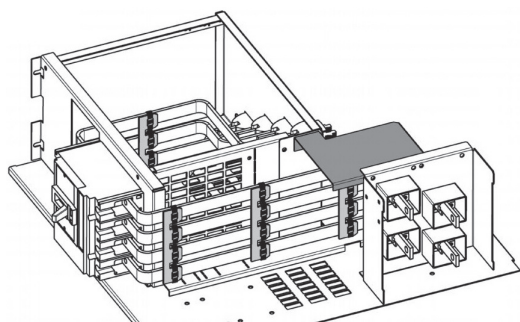

Secondary distribution

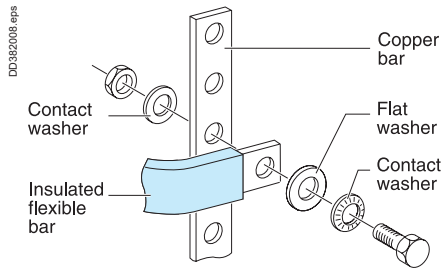

Connection between busbars

Copper flexible bars are designed for connections between busbars taking into account the following characteristics:

- a maximum temperature of 60 °C inside the switchboard. This corresponds to the average temperature inside a switchboard for an ambient temperature of 35 °C
- the maximum withstand temperature for the insulating material is 125 °C.

le (1) max	Size (mm)	Catalog numbers
200 A	20 x 2	LVS04742
250 A	20 x 3	LVS04743
400 A	24 x 5	LVS04746
520 A	32 x 5	LVS04751
580 A	32 x 6	LVS04752
660 A	32 x 8	LVS04753

(1) Rated operational current.

Designing connections

> page G-20.

Linerger DX

Quick distribution blocks

Distribution blocks



IEC 60947-7-1, CEI 61439-2

Description

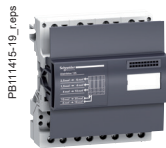
- Downstream circuits are connected from the front, to spring terminals.
- Contact pressure automatically adapts to the size of the conductor.
- Contacts are insensitive to vibrations and thermal variations.
- Only one cable (flexible or rigid) can be inserted per terminal.



Quick distribution blocks

Number of poles	4P, upstream incoming	4P, downstream incoming
		
Rated operational current at 40° (Ie)	63 A	63 A
Rated conditional short-circuit current of an assembly (Isc)	The reinforced breaking capacity due to cascading in circuit breaker combinations is maintained. The worst-case situations have been tested. 150 kA with upstream protection of 150 kA Icc	
Rated peak withstand current (Ipk)	10 kA	10 kA
Rated insulation voltage (Ui)	500 V AC	500 V AC
Rated operational voltage (Ue)	440 V AC	440 V AC
Rated impulse withstand voltage (Uimp)	6 kV	6 kV
Rated short-time current (Icc)	150 kA	150 kA
Thermal stress (I².t)	9.03 x 10 ⁶	9.03 x 10 ⁶
Rated operational frequency	50/60 Hz	50/60 Hz
Degree of protection	IPxxB	IPxxB
Incoming terminals	1 tunnel terminal 25 ² /phase	1 tunnel terminal 25 ² /phase
Total connection capacity, outgoing terminals	24 connections: 4 x 6 ² /phase 12 x 6 ² /neutre	24 connections: 4 x 6 ² /phase 12 x 6 ² /neutre
Dimensions (H x W x D)	96.5 x 72 x 62 8 x 9 mm pitch	96.5 x 72 x 62 8 x 9 mm pitch
Installation	Clipped onto a DIN rail	Clipped onto a DIN rail
Others		
Standard for installation inside PrismaSeT	IEC 61439-2	IEC 61439-2
Glow-wire 60695-2-11	960 °C	960 °C
Degree of pollution	3	3
Catalog numbers	LVS04040	LVS04041

Accessories

Catalog numbers	-	-
-----------------	---	---



Linergy DX

Quick distribution blocks

Distribution blocks

Advantages

- A reliable electrical connection, no maintenance required (tightness guaranteed over time).
- Quick connection.
- Easy phase balancing.
- Ease of rewiring if the switchboard is expanded or modified.

4P		1P
		
125 A	160 A	160 A
The reinforced breaking capacity due to cascading in circuit breaker combinations is maintained. The worst-case situations have been tested. 150 kA with upstream protection of 150 kA lcc		
20 kA	20 kA	24 kA
750 V AC	750 V AC	750 V AC
690 V AC	690 V AC	690 V AC
8 kV	8 kV	8 kV
150 kA	150 kA	150 kA
2.025 x 10 ⁷	2.025 x 10 ⁷	3.025 x 10 ⁷
50/60 Hz	50/60 Hz	50/60 Hz
IPxxB	IPxxB	IPxxB
1 tunnel terminal 35 ² /phase	Supplied with a prefabricated flexible connection equipped with tunnel terminals (for INS-INV100/160 use adaptor 28947 (3P) 28948 (4P))	1 tunnel terminal 70 ² /phase
52 connections: 7 x 4 ² /phase 3 x 6 ² /phase 2 x 10 ² /phase 1 x 16 ² /phase (screw terminal)	52 connections: 7 x 4 ² /phase 3 x 6 ² /phase 2 x 10 ² /phase 1 x 16 ² /phase (screw terminal)	6 connections: 6 x 16 ² /phase
127 x 108 x 48 12 x 9 mm pitch	127 x 108 x 48 12 x 9 mm pitch	95 x 36 x 70 4 x 9 mm pitch
Screwed to plain or slotted backplate or onto DIN rail	Screwed to plain or slotted backplate or onto DIN rail	Onto DIN rail
Possible to combine 2 terminal blocks (2 nd terminal block supplied from enclosed terminals in the 1 st , I _{max} of 2 nd terminal block: 80 A)		
IEC 61439-2	IEC 61439-2	IEC 61439-2
960 °C	960 °C	960 °C
3	3	3
LVS04045	LVS04046 (1)	LVS04031
4 x 125 A flexible connections, L = 240 mm with 1 end fitting for tunnel terminals.		4 x 160 A flexible connections, L = 380 mm with 2 x 45 mm ² end fittings for tunnel terminals.
LVS04047 (1)	-	LVS04149

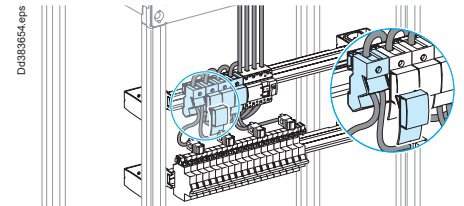
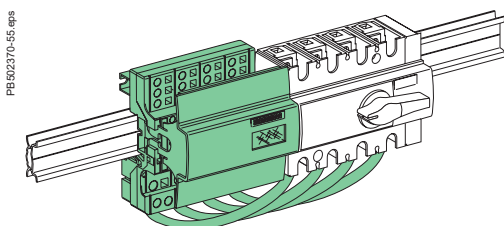

Note: electrical characteristics > page G-39.
(1) To be adapted with reference **28947** and **28948** fir INS-INV160.

Linergy FM

Quick device feeders

Device feeders

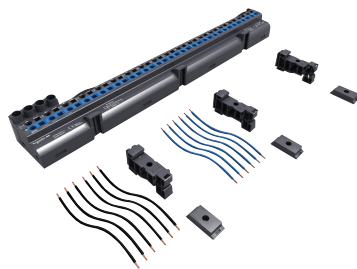

PE104505-50.eps



Description

- Distribution over full rows of modular devices.
- The distribution block is generally supplied by busbars in enclosures and cubicles.
- Easy phase balancing.
- Mix of devices and functions in the same row.
- Installation ≥ 160 A: clipped onto the back of a modular rail or screwed onto a solid or pre-slotted plate.

Distribution blocks

Number of poles		4P	4P
			
		PE632483-31_r.eps	PE104501-52-r.eps
Rated peak withstand current (I _{pk})		63 A	80 A
Rated conditional short-circuit current of an assembly (I _{sc})		12 kA	13 kA
Rated insulation voltage (U _i)		500 V AC	500 V AC
Rated voltage (U _e)		440 V AC	440 V AC
Rated impulse withstand voltage (U _{imp})		6 kV	8 kV
Maximum current (I _{max})		-	-
Thermal stress (I ² .t)		9.03 x 10 ⁶	9.03 x 10 ⁶
Rated operational frequency		50/60 Hz	50/60 Hz
Degree of protection		IPxxB	IPxxB
Width		9 mm modules 18 mm modules	24 48
Supply at incoming terminals		Enclosed terminals for cables up to 25 mm ²	Enclosed terminals for cables up to 25 mm ²
Downstream connection capacity, cable to be used without ferrules	Max. 4 mm ²	Phase	6
		Neutral	4
	Max. 6 mm ²	Phase	2
		Neutral	4
Max. 10 mm ²	Phase	-	
	Neutral	-	
Accessories included	Pre-stripped copper connections	10 x 4 mm ² + 6 x 6 mm ² (W = 100 mm)	20 x 4 mm ² + 6 x 6 mm ² (W = 100 mm)
	Protection cover	-	-
	Fixing legs	2	3
Catalog numbers		LVS04008	LVS04004

Installation

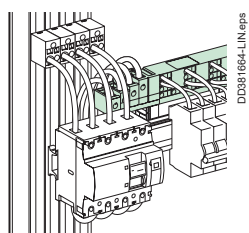

DD381664-LIN.eps

Clipped onto the back of a modular rail, or screw fixing.

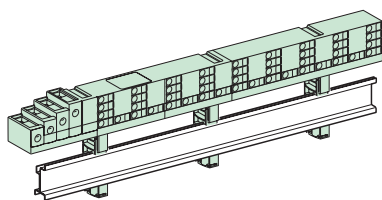

DB124195-LIN.eps

Clipped onto the back of a modular rail.

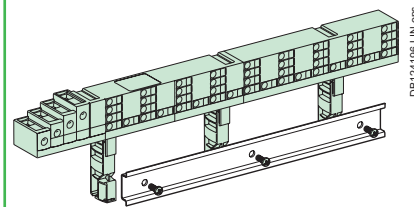

DB124196-LIN.eps





Clipped onto the back of a modular rail, or screw fixing.

Linerger FM

Quick device feeders



Device feeders



4P	1P+N	3P	4P	4P
				
PB502500-18_r_eps	PB502498-23_r_eps	PB502498-27_r_eps	PE502497-27_r_eps	PB502501-27_r_eps
160 A	200 A	200 A	200 A	200 A
20 kA	20 kA	20 kA	20 kA	20 kA
The cascading reinforced breaking capacity when combining circuit breakers is maintained. The worst-case scenarios have been tested. The characteristics are exactly right for the connected devices. Circuit breakers and switches still have their temperature derating curves, and their whole performance is maintained. 150 kA with upstream protection of 150 kA Icc				
750 V AC	750 V AC	750 V AC	750 V AC	750 V AC
690 V AC	690 V AC	690 V AC	690 V AC	690 V AC
8 kV	8 kV	8 kV	8 kV	8 kV
50 A for feeder for 10 mm ² cable/63 A for feeder for 2 10 mm ² cables				
3600 x 10 ⁷	3600 x 10 ⁷	3600 x 10 ⁷		3600 x 10 ⁷
50/60 Hz				
IPxxB				
24	48			72
12	24			36
Direct onto the row by cable 50 mm ² with crimped lug, or flexible bar 20 x 3 from busbar with prefabricated connection				
-	-			-
-	-			-
-	-			-
-	-			-
6	12			-
6	18			-
12 x 10 mm ²	24 x 10 mm ²	24 x 10 mm ²	24 x 10 mm ²	36 x 10 mm ²
4	2	3	4	4
2	4	4	4	6
LVS04018 (1)	LVS04012 (1)(2)	LVS04013 (1)	LVS04014 (1)(2)	LVS04026 (1)

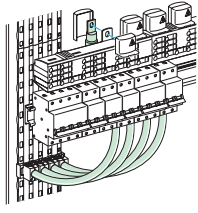
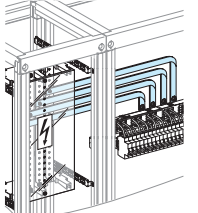

Connections to the distribution block

				
	DD38E348_eps	D438E355_eps		
	4P 200 A connection (supplied with fixings)	4P 200 A connection (supplied with fixings)	4P 200 A connection (supplied with fixings)	4P 160 A connection for Linergy FM 1/2 row
Allows power supply from	Linergy BW busbars	Linergy BS busbar	Rear Linergy BS busbar	Devices
Catalog numbers	LVS04021	LVS04024	LVS04029	LVS04030

Spare parts

	
	PB502502-8_r_eps
	4 covers for 160/200 A Linergy FM rows
Catalog numbers	LVS01202

Note: electrical characteristics > page G-39.

(1) Cable to be used without tip.

(2) Use Linergy FM 200 (LVS04012 and LVS04014) in Direct Current is possible. It is mandatory to locate on the device the nature of the terminals ⊕ and ⊖ at upstream and downstream. For more information, please contact our customer service.

Linergy DS

Screw distribution blocks

Distribution blocks



IEC/EN 60947-7-1, IEC/EN 61439-1 & 2





Description

- Single-pole or four-pole distribution block that can be installed on a standard DIN rail or on a mounting plate.
- Compatible with PrismaSeT G Active and PrismaSeT P Active, Pragma, Mini Pragma and Resbo series switchboards.
- Incomers and feeders are connected to screw terminals that accept rigid or flexible cables with ferrule.
- Optional: additional neutral terminal strip for four-pole distribution block.

Avantages

- Simplified power supply for main incomers.
- Easy phase balancing.
- Easy, effortless cabling due to excellent accessibility.
- Visible cabling.
- Insulation between phases.
- The single-pole distribution blocks are adjacent and bridgeable via the second incoming hole for parallel connection.

Screw distribution blocks

Number of poles	1P			4P
				
Rating	125 A	160 A	250 A	100 A
Total connection capacity	10	13	14	4 x 7
Terminal capacity				
Diameter	2 x Ø9.5 mm	2 x Ø12 mm	1 x Ø15.3 mm	2 x Ø7.5 mm
	2 x Ø7.5 mm	3 x Ø7.5 mm	1 x Ø10 mm	5 x Ø5.5 mm
	6 x Ø5.8 mm	8 x Ø5.8 mm	4 x Ø6 mm	-
	-	-	8 x Ø7.5 mm	-
Rated peak withstand current (I _{pk})	I _{pk} /60 ms	25 kA	36 kA	60 kA
	I _{pk} /6 ms	-	-	-
Rated short-time withstand current (I _{cc}) (IEC/EN 60947-7-1)	36 kA	36 kA	36 kA	20 kA
Width (number of 9 mm pitches)	3	4	5	8
Dimensions (H x W x D)	85 x 27 x 50.5	85 x 36 x 50.5	85 x 45 x 50.5	100 x 71 x 50.5
Weight (g)	125	163	239	210
Neutral terminal strip (optional)	-	-	-	LGYN1007
Catalog numbers	LGY112510	LGY116013	LGY125014	LGY410028

Linergy DS

Screw distribution blocks

Distribution blocks

Technical data

Common characteristics

In compliance with IEC/EN 60947-7-1 and IEC/EN 61439-1 & 2

Rated insulation voltage (Ui)	500 V AC
Rated operational voltage (Ue)	230 V AC (L/N) 440 V AC (L/L)
Rated impulse withstand voltage (Uimp)	8 kV
Rated conditional short-circuit current of an assembly	Up to the breaking capacity of Schneider Electric feeder circuit breakers, even in cascading configuration
Network frequency	50/60 Hz
Degree of pollution	3
Overtoltage category	III

Additional technical characteristics

Reference temperature	40 °C
Operating temperature	-25 °C to 55 °C
Dielectric withstand (IEC/EN 60947-1)	2500 V AC

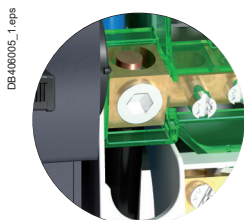

On LGY412560 and LGY416048 references.
Input cabling facilitated by side terminals.

			Neutral terminal strip		
125 A	160 A	100 A	125 A		
4 x 12	4 x 15	4 x 12	7	12	15
1 x Ø9 mm	1 x Ø9.5 mm	1 x Ø12 mm	2 x Ø7.5 mm	1 x Ø9 mm	1 x Ø9.5 mm
7 x Ø7.5 mm	3 x Ø8.5 mm	3 x Ø9 mm	5 x Ø5.5 mm	7 x Ø7.5 mm	3 x Ø8.5 mm
4 x Ø6.5 mm	11 x Ø6.5 mm	8 x Ø7.5 mm	-	4 x Ø6.5 mm	11 x Ø6.5 mm
-	-	-	-	-	-
18 kA	18 kA	22 kA	-	-	-
26 kA	28 kA	36 kA	-	-	-
36 kA	36 kA	36 kA	-	-	-
14	20	18	7	14	17
100 x 126 x 50.5	100 x 162 x 50.5	100 x 174 x 50.5	20 x 70 x 35	20 x 125 x 35	20 x 155 x 35
390	559	567	63	111	149
LGYN12512	LGYN12515	LGYN12512	-	-	-
LGY412548	LGY412560	LGY416048	LGYN1007	LGYN12512	LGYN12515

Terminal technical data

Type	PZ2 screw							
Diameter	Ø5.5 mm	Ø5.8 mm	Ø6 mm	Ø6.5 mm	Ø7.5 mm	Ø8.5 mm	Ø9 mm	Ø9.5 mm
Section rigid cable	1.5 to 16 mm ²	1.5 to 16 mm ²	1.5 to 16 mm ²	1.5 to 16 mm ²	2.5 to 25 mm ²	6 to 35 mm ²	10 to 35 mm ²	10 to 35 mm ²
Section flexible cable or with ferrule	1.5 to 10 mm ²	1.5 to 10 mm ²	1.5 to 10 mm ²	1.5 to 10 mm ²	1.5 to 16 mm ²	4 to 25 mm ²	4 to 25 mm ²	6 to 35 mm ²
Tightening torque	2 N.m	2 N.m	2 N.m	2 N.m	2 N.m	2 N.m	2.5 N.m	2.5 N.m
Type	HC screw							
Diameter	Ø9.5 mm	Ø10 mm	Ø12 mm	Ø15.3 mm				
Section rigid cable	10 to 35 mm ²	1.5 to 50 mm ²	25 to 70 mm ²	35 to 120 mm ²				
Section flexible cable or with ferrule	6 to 35 mm ²	1.5 to 35 mm ²	16 to 50 mm ²	25 to 95 mm ²				
Tightening torque	8 N.m	4 N.m	1P: 9 N.m 4P: 5 N.m	14 N.m				

Linergy FH

Comb busbar for 27 mm pitch for C120, NG125

Device feeders

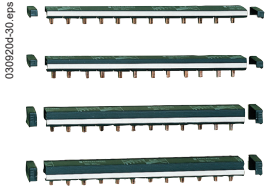

IEC 60664-1

Description

Comb busbars make it easier to install C120 and NG125 circuit breaker.

- Supplied with 2 lateral end-caps, to reinforce copper bars insulating (IP2).
- Allowing circuit identification.
- Easy cut to length thanks to cutting marks on the insulating material and copper bars.

C120, NG125		27 mm poles, cuttable			
Number of poles	1P	2P	3P	4P	
	Each com busbar reference includes: ■ 1 x single or 2 pole comb busbar + 8 tooth-caps + 2 side plates ■ 1 x 3 or 4 pole comb busbar + 4 tooth-caps + 2 side plates To insulate teeth that have been left free can be insulated by tooth-caps				
Rated operational current to 40 °C (Ie)	125 A (63 A max by outgoer)				
Rated conditional short-circuit current of an assembly (Isc)	Compatible with the breaking capacity of C120 and NG125 circuit breakers				
Rated insulation voltage (Ui)	620 V AC				
Rated voltage (Ue)	500 V AC				
Degree of pollution	3				
Fire resistance to IEC 695-2-1	Self-extinguishing 960 °C, 30 s				
Colour	RAL 7016 (anthracite grey)				
Use					
	Power supply by connector recommended				
Number of 27 mm modules	16	16	15	16	
Set of	1				
Catalog numbers	14811	14812	14813	14814	

Installation

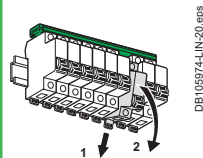

Comb busbars allow dismantability of switchgear.

Accessories

Number of poles	1P, 2P, 3P, 4P	
	Tooth caps	Insulated connector
		Compatible with all Schneider Electric comb busbars Clip onto the comb busbar's insulating material, which gives them very great stability Receive clip-on markers allowing circuit identification
Use		
		For 25 mm ² semi-rigid cable
Set of	20	4
Catalog numbers	14818	14885

Installation

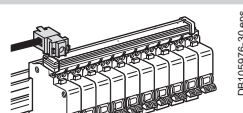
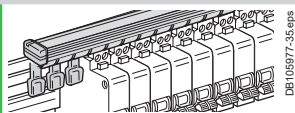

Linergy FH

Comb busbar for 18 mm pitch for Acti 9

Device feeders

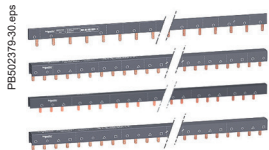

IEC 60947-7-1, IEC 61439-2

Description

Comb busbars make it easier to install Acti 9 circuit breakers.

- Can be sawn and cut in a single pass, with a metal saw (the end-caps are compulsory after cutting).
- Supplied with two lateral end-caps to reinforce copper bars insulating (IP2) except for 57 module references. The side plates are compulsory after cutting.
- Easy cut to length thanks to cutting marks on the insulating material and copper bars.
- The phases are identified by symbols on each side of the comb busbar for installation in all positions.
- The special comb busbars for circuit breakers with 9 mm auxiliaries have a 9 mm gap for inserting iOF and iSD.

Acti 9	18 mm poles, cuttable										
Number of poles	1P	2P	3P	4P	3 (N+P)	Aux+1P	Aux+2P	Aux+3P	Aux+4P	3 (Aux+1P)	3 (Aux+N+1P)
Rated operational current at 40 °C (Ie)	100 A										
Rated conditional short-circuit current of an assembly (Isc)	Compatible with the breaking capacity of Acti 9 circuit breakers										
Rated insulation voltage (Ui)	500 V AC										
Rated voltage (Ue)	415 V AC										
Degree of pollution	3										
Fire resistance to IEC 695-2-1	Self-extinguishing 960 °C, 30 s										
Colour	RAL 7016 (anthracite grey)										
Use											
	Power supply by connector recommended										
Type	L1...	L1L2...	L1L2L3...	NL1L2L3...	NL1NL2... ...NL3	AuxL1...	AuxL1L2...	AuxL1L2L3	AuxNL1... ...L2L3	AuxL1... ...AuxL2... ...AuxL3	AuxL1... ...AuxL2... ...AuxL3
Set of	1	1	1	1	1	1	1	1	1	1	1
Catalog numbers											
6 modules of 18 mm	A9XPH106	-	-	-	-	-	-	-	-	-	-
12 modules of 18 mm	A9XPH112	A9XPH212	A9XPH312	A9XPH412	A9XPH512 (1)	-	-	-	-	-	-
18 modules of 18 mm	-	-	-	-	A9XPH518 (1)	-	-	-	-	-	-
24 modules of 18 mm	A9XPH124	A9XPH224	A9XPH324	A9XPH424	A9XPH524 (1)	-	-	-	-	-	-
57 modules of 18 mm	A9XPH157	A9XPH257	A9XPH357	A9XPH457	A9XPH557 (1)	A9XAH157	A9XAH257	A9XAH357	A9XAH457	A9XAH657	A9XAH557 (1)

(1) This comb busbar is only compatible in top feeding for simple lug devices and bottom feeding on double lug devices.

Installation

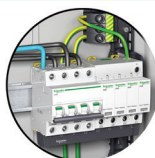

PB110290-20 eps



PB110793-20 eps

Accessories

Number of poles	1P	2P	3P	4P	-	-	-	
	Side plates				Tooth covers		Connectors	
	Lateral end-caps providing IP20 protection				To insulate teeth that have been left free		Monoconnect Comb busbar power supply. Horizontal incomer on each side. For 35 mm ² cable. Tightening torque 4 N.m 	
Set of	10	10	10	10	20	4	4	
Catalog numbers	A9XPE110	A9XPE210	A9XPE310	A9XPE410	A9XPT920	A9XPCM04	A9XPCD04	

Linergy FH

Comb busbar for 18 mm pitch for Acti 9

Device feeders

IEC 60947-7-1, IEC 61439-2

Description

- Comb busbars make it easier to install Acti 9 circuit breakers.
- The phases are identified by symbols on each side of the comb busbar for installation in all positions.

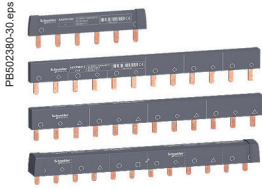

Acti 9		18 mm poles, not cuttable				
Number of poles	1P	2P	3P	4P	3 (N + P)	
Rated operational current to 40 °C (Ie)	100 A					
Rated conditional short-circuit current of an assembly (Isc)	Compatible with the breaking capacity of Acti 9 circuit breakers					
Rated insulation voltage (Ui)	500 V AC					
Rated voltage (Ue)	415 V AC					
Degree of pollution	3					
Fire resistance to IEC 695-2-1	Self-extinguishing 960 °C, 30 s					
Colour	RAL 7016 (anthracite grey)					
Use						
Type	Power supply by connector recommended					
Set of	L1	L1L2	L1L2L3	NL1L2L3	NL1NL2NL3	
Catalog numbers	-	A9XPM212	-	A9XPM412	A9XPM512 (1)	
12 modules of 18 mm						

Installation

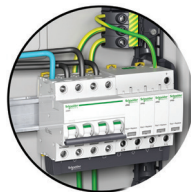

Accessories

Tooth caps	Connectors	Double terminals	
To insulate teeth that have been left free	Monoconnect	Comb busbar power supply	
Use			
		Horizontal incomer on each side For 35 mm ² cable Tightening torque 4 N.m	
Set of	20	4	4
Catalog numbers	A9XPT920	A9XPCM04	A9XPCD04
Installation			

(1) This comb busbar is only compatible in top feeding for simple lug devices and bottom feeding on double lug devices.

Linergy FH

Comb busbar for 9 mm pitch for Acti 9, C60

Device feeders

IEC 60439-1

Description

Comb busbars ensure:



- Easy, reliable mounting of 1P+N and 3P+N, TL, CT, ID, V, BP and Cm switchgear: tooth positioning opposite the device terminals is ensured by indexing of copper parts.

C60/ID Group Feeder comb busbars contain two different parts:

- connection of Group Feeder switchgear: C60 (3P + N) or ID (3P + N) circuit breaker in 18 mm modules, powered by cables, through the bottom, directly by the terminals
- connection of Acti 9 switchgear in 9 mm modules.

PB502302-70.eps



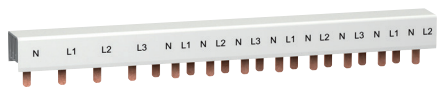

Acti 9 L + N		9 mm poles, cuttable					
Number of poles		1P + N			3P + N		
							
		21501			21505		
		Complete comb busbars (supplied with 4 side plates and 1 tooth cap)					
Rated operational current to 40 °C (Ie)		80 A					
Rated conditional short-circuit current of an assembly (Isc)		Compatible with the breaking capacity of Acti 9 C60 and circuit breakers					
Rated insulation voltage (Ui)		440 V AC					
Rated voltage (Ue)		230 V AC (P + N) - 400 V AC (3P + N)					
Rated impulse withstand voltage (Uimp)		6 kV					
Degree of protection		IP20					
Degree of pollution		3					
Fire resistance to IEC 695-2-1		Self-extinguishing 960 °C, 30 s					
Colour		RAL 7035					
Number of 18 mm modules	Comb busbar	12	18	24	12	18	24
	Tooth cap	3	3	6	3	3	6
Catalog numbers		21501	19512	21503	21505	19516	21507
Comb busbars alone							
Number of 18 mm modules	Comb busbar	48			48		
		21089			21093		

C60/ID Group Feeder comb busbars alone

Number of poles		3P + N		
				
		PB502306-60-r.eps		
Rated operational current to 40 °C (Ie)		80 A		
Rated conditional short-circuit current of an assembly (Isc)		Compatible with the breaking capacity of Schneider Electric circuit breakers		
Rated insulation voltage (Ui)		440 V AC		
Rated voltage (Ue)		230 V AC (P + N) - 400 V AC (3P + N)		
Rated impulse withstand voltage (Uimp)		6 kV		
Degree of protection		IP20		
Degree of pollution		3		
Fire resistance to IEC 695-2-1		Self-extinguishing 960 °C, 30 s		
Colour		RAL 7035		
Number of 18 mm modules		12	48	48
	Power supply	Through left-hand	Through left-hand	Through right-hand
Catalog numbers		10545	10546	10547

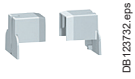
Accessories

Number of poles	1P + N	3P + N	
			
	DB123732.eps	DB123733.eps	DB123731.eps
	Side plates	Tooth caps (3 x 18-mm modules)	Tooth caps (1 x 18-mm modules)
Set of	40	12	10
Catalog numbers	21094	21095	21096
			10405
			21098

Linergy FH

Comb busbar for 9 mm pitch for Acti 9

Device feeders

IEC 60439-1

Description

- Connection of Clario, Prodis and Librio switchgear in 9 mm modules.
- The special comb busbars for circuit breaker have a gap of 9 mm for inserting OF, SD, OF-SD/OF auxiliaries.
- The comb busbars for 3P + N circuit breakers and auxiliaries are compatible with PrismaSeT switchboard.
- 1P+N comb busbars are compatible with PrismaSeT and Pragma 24.

PB502389-10.eps

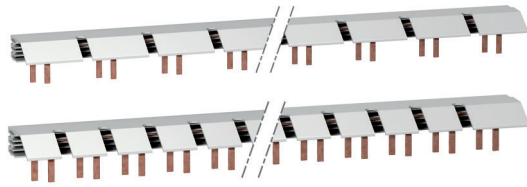

Acti 9		9 mm poles, cuttable			
Number of poles		1P + N	3P + N	1P + N	3P + N
		A9N21036		DPN Vigi comb busbars	
Rated operational current to 40 °C (Ie)		63 A			
Rated conditional short-circuit current of an assembly (Isc)		Compatible with the breaking capacity of Acti 9 circuit breakers			
Rated insulation voltage (Ui)		500 V AC			
Rated voltage (Ue)		230 V AC (P + N) - 400 V AC (3P + N)			
Degree of protection		IP20			
Degree of pollution		3			
Fire resistance to IEC 695-2-1		Self-extinguishing 960 °C, 30 s			
Colour		RAL 7035			
Number of 18 mm modules		56	56	56	56
Catalog numbers		A9N21035	A9N21036	A9N21037	A9N21038

PB110801-10.eps

Accessories

Number of poles	1P + N	3P + N			
	Side plates	Connectors (grey)	Neutral connectors (blue)	Tooth cap (1 x 18 mm module)	
Set of	20	10	10	10	
Catalog numbers	A9N21039	A9N21040	A9N21041	A9N21042	A9N21050

Linergy FH

Horizontal comb busbar for 18 mm pitch for Domae

Device feeders

IEC 60439-1, IEC 60664

Description

Comb busbars:

- Comb busbars ensure: Easy, reliable mounting of 1P+N and 3P+N, TL, CT, ID, V, BP and Cm switchgear: tooth positioning opposite the device terminals is ensured by indexing of copper parts
- Can be sawn and cut in a single pass, with a metal saw (the end-caps are compulsory after cutting).
- Are supplied with 2 (IP20) lateral end-caps (mandatory).
- Teeth that have been left free can be insulated by tooth-caps.

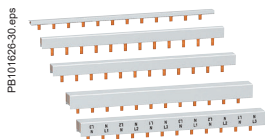

Domae		18 mm poles, cuttable								
Number of poles		1P	2P	3P	4P	3P (N + P)				
Rated operational current to 40 °C (Ie)		63 A								
Rated conditional short-circuit current of an assembly (Isc)		Compatible with the breaking capacity of circuit breakers								
Rated insulation voltage (Ui)		500 V AC								
Rated voltage (Ue)	L/N	230 V AC								
	L/L	400 V AC								
Degree of pollution		3								
Fire resistance to IEC 695-2-1		Auto-extinguible to 850 °C 30 secondes								
Colour		RAL 7035								
Power supply		By 16 mm ² semi-rigid cables or 10 mm ² flexible cables								
		By connector								
Number of 18 mm modules		12	57	12	57	12	57	12	57	57
Catalog numbers		10387	10388	10389	10390	10391	10392	10393	10394	10395

Installation

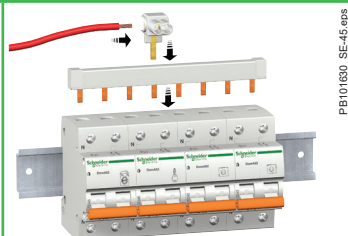

Accessories

Type	Connectors (4 x 35 mm ²)	Side plates (2 phases)	Side plates (3 phases)	Side plates (4 phases)	Tooth caps
Set of	1	10	10	10	10
Catalog numbers	10397	10398	10399	10405	10396

Linergy FH

Horizontal biconnect comb busbar for 18 mm pitch

Device feeders

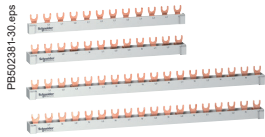

IEC 60664-1

Description

- Distribution and sub-distribution of the electric power supply.
- Fast assembly and disassembly of connected devices.

Comb horizontal bi-connection		18 mm poles, cuttable											
Number of poles	1P			2P			3P			4P			
Rated operational current to 40 °C (Ie)	63 A												
Rated conditional short-circuit current of an assembly (Isc)	Compatible with the breaking capacity of circuit breakers												
Rated insulation voltage (Ui)	500 V AC												
Rated voltage (Ue)	L/N 230 V AC												
	L/L 400 V AC												
Degree of pollution	3												
Fire resistance to IEC 695-2-1	Self-extinguishing 960 °C, 30 s												
Colour	RAL 7035 (grey)												
Use													
Power supply: directly on terminal (25 mm ² rigid or 16 mm ² flexible) or by connector (35 mm ² rigid or 25 mm ² flexible with ferrule)													
Type	L1			L1L2			L1L2L3			L1L2L3L4			
Number of 18 mm modules	12	18	57	12	18	57	12	18	57	12	18	57	
Set of	1	1	1	1	1	1	1	1	1	1	1	1	
Catalog numbers	R9XFH112	R9XFH118	R9XFH157	R9XFH212	R9XFH218	R9XFH257	R9XFH312	R9XFH318	R9XFH357	R9XFH412	R9XFH418	R9XFH457	

Installation

Comb busbars horizontal bi-connection		18 mm poles, cuttable		
Number of poles	4P			
Rated operational current to 40 °C (Ie)	63 A			
Rated conditional short-circuit current of an assembly (Isc)	Compatible with the breaking capacity of Schneider Electric circuit breakers			
Rated insulation voltage (Ui)	500 V AC			
Rated voltage (Ue)	L/N 230 V AC			
	L/L 400 V AC			
Degree of pollution	3			
Fire resistance to IEC 695-2-1	Self-extinguishing 960 °C, 30 s			
Colour	RAL 7035 (grey)			
Use				
Type	NL1L2L3L4 - NL1NL2NL3		NL1NL2NL3	
Number of 18 mm modules	18		57	
Set of	1		1	
Catalog numbers	R9XFH518G		R9XFH518	
			R9XFH557	

Installation

Accessories						
Number of poles	1P	2P	3P	4P		
	Side plates				Tooth caps	
Set of	10				20	
Catalog numbers	R9XE110	R9XE210	R9XE310	R9XE410	R9XT20	R9XFC04

Linergy TA

Auxiliary connections

Terminal blocks and lines

Connectors

For plug & play interconnection between electrical switchboard for control and communication wires.

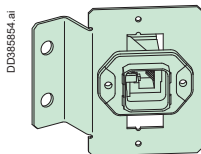

RJ45 female-female connector with mounting plate	
Connector type	8 wires RJ45; 1 Gbps
For ethernet cable	CAT5e SFTP (IEC 11801) or higher
Degree of protection	IP67 for direct mount
Dimensions (H x W x D)	(mm) 75 x 70 x 45
Catalog number	LGY4230

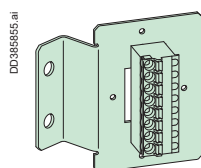

8P male-female connector with mounting plate	
Rated operational current at 40 °C	(Ie) 12 A
Rated operational voltage	(Ue) 320 V
Rated impulse withstand voltage	(Uimp) 4 kV
Connection method	Push-in spring connection
Connection capacity	Input 8
	Output 8
Dimensions (H x W x D)	(mm) 75 x 70 x 45
Wire size	0.2 to 2.5 mm ²
Catalog number	LGY4231

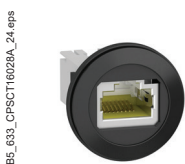

USB and RJ45 ports					
Description	Panel-mounted USB and RJ45 ports in 22.5 mm hole with notch				
Interface type	USB interface, jack type A	Ethernet interface, RJ45 jack	Plastic protection cover IP65/ IP67	Rigid plastic protection cover IP65/ IP67	Metal protection cover IP65/ IP67/IP69K
Connection type	USB port 3.0 A-A	RJ45 port Cat. 6	Ø 22 mm/0.866 in. USB and RJ45 ports		
Others characteristics	IP20 IP65, IP67, IP69K with protection cover		Black quantity:10	Transparent quantity:1	Silver quantity:1
Catalog number	XB5PUSB3	XB5PRJ45	ZBSP1	ZBSP2	ZBSP3



Linerger TB
Earth bars

Terminal blocks and lines

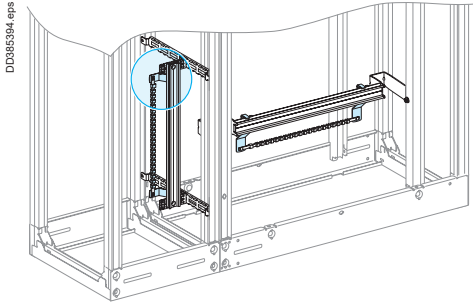

Description

This range of earth bars is installed:

- in the duct which can constitute a dedicated area, completely separate from the equipment
- or in the switchgear compartment, at the top or the bottom .

Fast-connecting earth bar

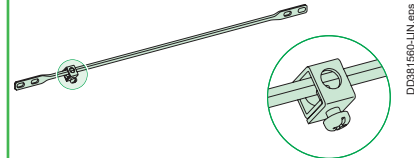

	Copper earth bar
Cross-section (mm)	12 x 3
Effective length (mm)	330
Total length (mm)	450
Composition	Copper bar with 1 terminal 16 to 35 mm ²
Rated short time withstand current (Icw)	9 kA rms/0.5 s
Catalog numbers	LVS04201

Accessories

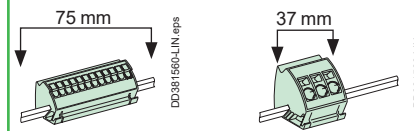

	Earth blocks with terminals	
	Spring-fixing (clip onto the earth bar)	
Total connection capacity	12 x 4 mm ²	3 x 16 mm ²
Composition	4 earth blocks	4 earth blocks
Rated short time withstand current (Icw)	1 kA rms/0.5 s	4 kA rms/0.5 s
Catalog numbers	LVS04214	LVS04215

Accessories

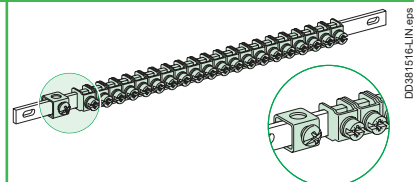

	Copper earth bar with jumper	
Total connection capacity	40 x 2.5 to 16 mm ²	20 x 2.5 to 16 mm ²
Cross-section (mm)	12 x 3	12 x 3
Length (mm)	450	200
Composition	40 jumpers and a terminal (16 to 35 mm ²)	20 jumpers and a terminal (16 to 35 mm ²)
Rated short time withstand current (Icw)	9 kA rms/0.5 s	9 kA rms/0.5 s
Catalog numbers	LVS04200	LVS04202

Accessories

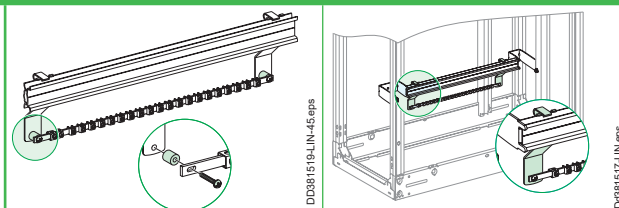

	Neutral bar	Earth bar
	Converts an earth bar to a neutral bar	
Composition	2 insulating spacers	2 supports for earth bar on modular rail
Catalog numbers	LVS04210	LVS04205

Linergy TB
PE conductor

Terminal blocks and lines

PE conductor							
	Vertical PE conductor with Linergy LGY profile (W = 1670 mm)			Vertical PE conductor with Linergy BS busbar (W = 1675 mm)		Horizontal PE conductor with Linergy BS busbar	
Rated short-time current (Isc)	≤ 65	> 65... ≤ 80	= 100	≤ 40	> 40	≤ 40	> 40
Permissible current (A)	630	800	1250	400	600	400	600
Bar size (mm)				25 x 5	50 x 5	25 x 5	50 x 5
Characteristics				Drilled flat bar Ø10.6 mm (one 10.6 mm hole every 25 mm along the entire length)	Drilled flat bar Ø10.6 mm (two 10.6 mm hole every 25 mm along the entire length)		
Catalog numbers	LVS04502	LVS04503	LVS04505	LVS04512	LVS04515	LVS04512	LVS04515

Support selection		
Composition	Three supports for one vertical PE (supplied with PE marking) to secure to the framework	Two supports for one horizontal PE
Catalog numbers	LVS04657	LVS04667

Connection between PE conductors		
	Connection plates for horizontal/vertical PE bars	Linergy connection hardware
Composition	2 copper angle brackets	20 M8 bolts (W = 25 mm) + 20 nuts + 20 contact washers for connection to cable lugs or flexible bars
Catalog numbers	LVS04672	LVS04766

PEN conductor		
	Linergy TB PEN installation kit with LGY vertical profile	1600 A connection 10 mm horizontal busbar with Linergy LGY profile
Catalog numbers	LVS04656 (1)	LVS04636
		Linergy LGYE vertical connection 1600 A
Catalog numbers		LVS04602

Note: for further details > page I-12.

(1) For LGYE HBB, additional fish plate need to be manufactured as per the drawing supplied by Schneider Electric.

Linergy TB terminal block support

Secondary distribution

Introduction

In Prisma**SeT** P Active cubicles, terminal blocks are commonly installed in a lateral compartment, generally 300 or 400 mm wide. They may also be installed at the top or bottom of the cubicle.

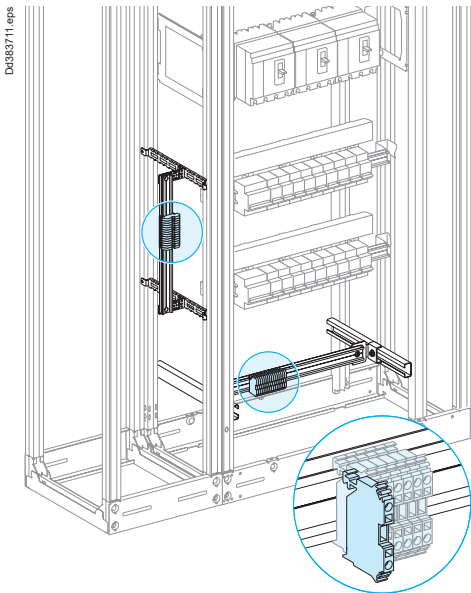

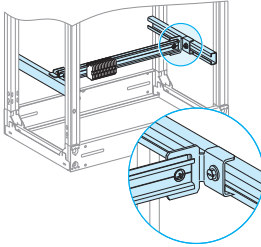
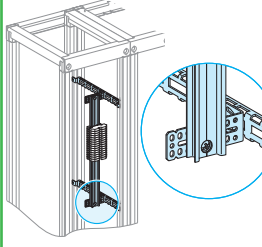
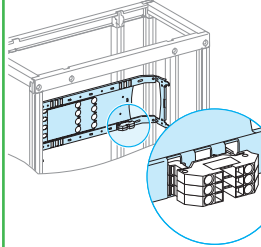
	Installation at top or bottom of a cubicle	Installation in a lateral compartment	Installation on a device mounting plate
			
Modular rail, depth adjustable (W = 432 mm)	LVS03402	-	-
2 modular rails W = 1600 mm	LVS04226	LVS04226	-
2 universal angle brackets	LVS03581	LVS03581	-
Set of two lateral cross-members W = 400 mm	LVS03584	-	-
Characteristics	Terminal blocks are grouped on modular rails that can be depth adjusted behind a plain front plate.	The terminal block is generally installed in the cable compartment, W = 300 or 400 mm. The terminal blocks clip onto a modular rail. The rail is secured to cable-tie supports using universal angle brackets for precise positioning of the terminal blocks.	Terminal blocks can be directly installed on the mounting plates for horizontally mounted ComPacT NSX100/630 and vertically mounted ComPacT NS630b/1600 for connection of auxiliary wires.

Width of standard terminal blocks

Max. cable CSA (mm ²)	4	6	10	16
Width of terminal block (mm)	6	8	10	12

Height required in switchboard

Max. cable CSA (mm ²)	4	6	10	16
No. of vertical modules	3	3	5	6
Plain front plate	LVS03803	LVS03803	LVS03805	LVS03806

Designing connection ≤ 630 A

Auxiliary connections

Electrical characteristics



Device	Ambient temperature around the switchboard											
	25°C		30°C		35°C		40°C		45°C		50°C	
	IP ≤ 31	IP > 31	IP ≤ 31	IP > 31	IP ≤ 31	IP > 31	IP ≤ 31	IP > 31	IP ≤ 31	IP > 31	IP ≤ 31	IP > 31
Rated current of a circuit I_{nc} (A)												
Linerger BW												
Insulated bus bar Linergy BW 125A	134	125	129	120	125	116	120	111	116	106	110	■
Insulated bus bar Linergy BW 160A	171	160	166	154	160	148	154	142	148	135	142	■
Insulated bus bar Linergy BW 250	267	250	259	241	250	231	241	222	231	211	222	■
Insulated bus bar Linergy BW 400A	428	400	414	385	400	370	385	355	370	338	355	■
Insulated bus bar Linergy BW 630A	673	630	652	607	630	583	607	558	583	532	558	■
Linerger BS												
Rear flat busbars 160 A	171	160	166	154	160	148	154	142	148	135	142	■
Rear flat busbars 250 A	267	250	259	241	250	231	241	222	231	211	222	■
Rear flat busbars 400 A	428	400	414	385	400	370	385	355	370	338	355	■
Rear flat busbars 630 A	673	630	652	607	630	583	607	558	583	532	558	■
Linerger BS												
Multi-stage busbars 160 A	171	160	166	154	160	148	154	142	148	135	142	■
Multi-stage busbars 250 A	267	250	259	241	250	231	241	222	231	211	222	■
Multi-stage busbars block 400A	428	400	414	385	400	370	385	355	370	338	355	■
Multi-stage busbars block 630 A	673	630	652	607	630	583	607	558	583	532	558	■
Linerger BS												
Multi-stage distribution block 160 A	171	160	166	154	160	148	154	142	148	135	142	■
Multi-stage distribution block 250 A	267	250	259	241	250	231	241	222	231	211	222	■
Multi-stage distribution block 400A	428	400	414	385	400	370	385	355	370	338	355	■
Multi-stage distribution block 630 A	673	630	652	607	630	583	607	558	583	532	558	■
Linerger DX												
Quick distribution block Linergy DX 4P 125A	134	125	129	120	125	116	120	111	116	106	111	■
Quick distribution block Linergy DX 4P 160A	171	160	166	154	160	148	154	142	148	135	142	■
Quick distribution block Linergy DX 1P 1P 160A	171	160	166	154	160	148	154	142	148	155	142	■
Linerger DP												
Quick distribution block Linergy DP 3P-4P 160A	160	160	155	155	150	150	145	145	140	140	135	■
Quick distribution block Linergy DP 3P-4P 250A	267	250	259	241	250	231	241	222	231	211	222	■
Linerger FM												
Quick device feeders Linergy FM 4P 63A	67	63	65	61	63	58	61	56	58	53	56	■
Quick device feeders Linergy FM 4P 80A	86	80	83	77	80	74	77	71	74	68	71	■
Quick device feeders Linergy FM 4P 160A	171	160	166	154	160	148	154	142	148	135	142	■
Quick device feeders Linergy FM 2P 200A	214	200	207	193	200	185	193	177	185	169	177	■
Quick device feeders Linergy FM 3P 200A	214	200	207	193	200	185	193	177	185	169	177	■
Quick device feeders Linergy FM 4P 200A	214	200	207	193	200	185	193	177	185	169	177	■
Quick device feeders Linergy FM 4P 200A (36 modules)	214	200	207	193	200	185	193	177	185	169	177	■

■ Check the concordance between Linergy derating value and upstream protection device derating value.

Linergy TR
Terminal blocks

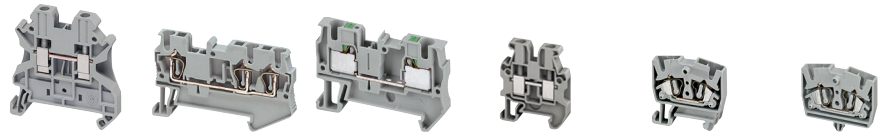
Secondary distribution

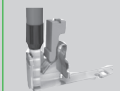

			Connection technology					
Type of terminal block	Cross section area	Color	Screw tech 	Spring tech 	Push-in tech 	Miniature screw for 15 mm DIN rail	Miniature spring for 15 mm DIN rail	Miniature spring for direct mount
Passthrough	2.5 mm ² (2 pts)	Grey	NSYTRV22	NSYTRR22	NSYTRP22	NSYTRV22M	NSYTRR22M	NSYTRR22MF
		Blue	NSYTRV22BL	NSYTRR22BL	NSYTRP22BL	NSYTRV22MBL	NSYTRR22MBL	NSYTRR22MFBL
		Orange	NSYTRV22AR	NSYTRR22AR	NSYTRP22AR	-	-	NSYTRR22MFF [*]
	2.5 mm ² (3 pts)	Grey	NSYTRV23	NSYTRR23	NSYTRP23	-	-	-
		Blue	NSYTRV23BL	NSYTRR23BL	NSYTRP23BL	-	-	-
		Orange	-	NSYTRR23AR	NSYTRP23AR	-	-	-
	2.5 mm ² (4 pts)	Grey	NSYTRV24	NSYTRR24	NSYTRP24	-	NSYTRR24M	NSYTRR24M
		Blue	NSYTRV24BL	NSYTRR24BL	NSYTRP24BL	-	NSYTRR24MBL	NSYTRR24MBL
	2.5 mm ² (4 pts, 2 levels)	Grey	NSYTRV24D	NSYTRR24D	NSYTRP24D	-	-	-
		Blue	NSYTRV24DBL	NSYTRR24DBL	NSYTRP24DBL	-	-	-
	2.5 mm ² (6 pts, 3 levels)	Grey	NSYTRV26T	NSYTRR26T	NSYTRP26T	-	-	-
		Blue	NSYTRV26TBL	NSYTRR26TBL	NSYTRP26TBL	-	-	-
	4 mm ² (2 pts)	Grey	NSYTRV42	NSYTRR42	NSYTRP42	NSYTRV42M	-	-
		Blue	NSYTRV42BL	NSYTRR42BL	NSYTRP42BL	NSYTRV42MBL	-	-
		Orange	NSYTRV42AR	NSYTRR42AR	-	-	-	-
	4 mm ² (3 pts)	Grey	NSYTRV43	NSYTRR43	NSYTRP43	-	-	-
		Blue	NSYTRV43BL	NSYTRR43BL	NSYTRP43BL	-	-	-
	4 mm ² (4 pts)	Grey	NSYTRV44	NSYTRR44	NSYTRP44	-	-	-
		Blue	NSYTRV44BL	NSYTRR44BL	NSYTRP44BL	-	-	-
	4 mm ² (4 pts, 2 levels)	Grey	NSYTRV44D	NSYTRR44D	-	-	-	-
Blue		NSYTRV44DBL	NSYTRR44DBL	-	-	-	-	
6 mm ² (2 pts)	Grey	NSYTRV62	NSYTRR62	-	-	-	-	
	Blue	NSYTRV62BL	NSYTRR62BL	-	-	-	-	
10 mm ² (2 pts)	Grey	NSYTRV102	NSYTRR102	-	-	-	-	
	Blue	NSYTRV102BL	NSYTRR102BL	-	-	-	-	
16 mm ² (2 pts)	Grey	NSYTRV162	NSYTRR162	-	-	-	-	
	Blue	NSYTRV162BL	NSYTRR162BL	-	-	-	-	
Earth protection	2.5 mm ² (2 pts)	Green/Yellow	NSYTRV22PE	NSYTRR22PE	NSYTRP22PE	NSYTRV22MPE	NSYTRR22MPE	-
	2.5 mm ² (3 pts)	Green/Yellow	NSYTRV23PE	NSYTRR23PE	NSYTRP23PE	-	-	-
	2.5 mm ² (4 pts)	Green/Yellow	NSYTRV24PE	NSYTRR24PE	NSYTRP24PE	-	-	-
	4 mm ² (2 pts)	Green/Yellow	NSYTRV42PE	NSYTRR42PE	NSYTRP42PE	NSYTRV42MPE	-	-
	4 mm ² (3 pts)	Green/Yellow	NSYTRV43PE	NSYTRR43PE	NSYTRP43PE	-	-	-
	4 mm ² (4 pts)	Green/Yellow	NSYTRV44PE	NSYTRR44PE	NSYTRP44PE	-	-	-
	6 mm ² (2 pts)	Green/Yellow	NSYTRV62PE	NSYTRR62PE	-	-	-	-
	10 mm ² (2 pts)	Green/Yellow	NSYTRV102PE	NSYTRR102PE	-	-	-	-
Knife Disconnect	2.5 mm ² (2 pts)	Grey	NSYTRV22SC	NSYTRR22SC	NSYTRP22SC	-	-	-
		Orange	NSYTRV22ST (1)	NSYTRR22SCAR	-	-	-	-
	2.5 mm ² (3 pts)	Grey	-	NSYTRR23SC	NSYTRP23SC	-	-	-
		Orange	-	NSYTRR23SCAR	-	-	-	-
2.5 mm ² (2 levels)	Grey	NSYTRV24SCD	NSYTRR24SCD	-	-	-	-	
Fuse Disconnect	4 mm ² (2 pts)	Black	NSYTRV42SF5	-	-	-	-	-
	5 x 20 mm fuse	Black (12 V)	NSYTRV42SF5LD (2)	-	-	-	-	-
		Black (230 V)	NSYTRV42SF5LA (2)	-	-	-	-	-
Basic Disconnect (3)	4 mm ² (2 pts)	Grey	NSYTRV42TB	NSYTRR42TB	NSYTRP42TB	-	-	-
Measuring transducer	6 mm ² (2 pts) Disconnect	Grey	NSYTRV62TTD	-	-	-	-	-
		Grey	NSYTRV62TT	-	-	-	-	-
	6 mm ² (2 pts)	Green/Yellow	NSYTRV62TTPE	-	-	-	-	-

* Grey terminal with flange.

(1) Grey disconnect terminal with 2 test points.

(2) With light indicator.

(3) Fuse or component carrier not supplied.

Linergy TR

Terminal blocks

Secondary distribution

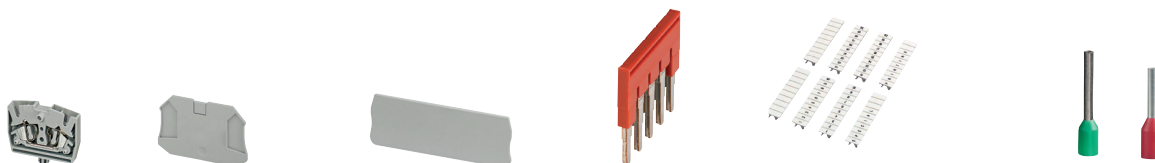

Accessories						
Miniature spring for direct mount	End plate for screw TBs	End plate for spring TBs	End plate for push-in TBs	Plug-in bridge	Marking strips 10 characters	
NSYTRR22MP	NSYTRAC22	NSYTRACR22	NSYTRACR22	NSYTRAL22	NSYTRABF510	
NSYTRR22MPBL	NSYTRAC22BL	NSYTRACR22BL	NSYTRACR22BL	NSYTRAL23	NSYTRABF520	
-	-	-	-	NSYTRAL24	NSYTRABF530	
-	NSYTRAC23	NSYTRACR23	NSYTRACR23	NSYTRAL25	NSYTRABF540	
-	-	NSYTRACR23BL	NSYTRACR23BL	NSYTRAL210	NSYTRABF550	
-	-	-	-	NSYTRAL210BL	NSYTRAB560	
NSYTRR24MP	NSYTRAC24	NSYTRACR24	NSYTRACR24	NSYTRAL210GR	NSYTRAB570	
NSYTRR24MPBL	-	NSYTRACR24BL	NSYTRACR24BL	NSYTRAL220	NSYTRAB580	
-	NSYTRACE24	NSYTRACRE24	NSYTRACRE24	-	NSYTRAB590	
-	-	-	-	-	NSYTRAB5100	
-	NSYTRACE26	NSYTRACRE26	NSYTRACPE26	-	NSYTRAB51100	
-	-	-	-	-	-	
-	NSYTRAC22	NSYTRACR42	NSYTRACR42	NSYTRAL42	NSYTRAB610	
-	NSYTRAC22BL	-	-	NSYTRAL43	NSYTRAB620	
-	-	-	-	NSYTRAL44	NSYTRAB630	
-	NSYTRAC23	NSYTRACR43	NSYTRACP43	NSYTRAL45	NSYTRAB640	
-	-	-	-	NSYTRAL410	...	
-	NSYTRAC24	NSYTRACR44	NSYTRACP44	NSYTRAL410BL	NSYTRAB690	
-	-	-	-	NSYTRAL410GR	NSYTRAB6100	
-	NSYTRACE24	NSYTRACRE44	-	NSYTRAL420	NSYTRAB61100	
-	-	-	-	-	-	
-	NSYTRAC22	NSYTRACR62	-	NSYTRAL62	NSYTRAB810	
-	NSYTRAC22BL	-	-	NSYTRAL65	NSYTRAB820	
-	NSYTRAC22	NSYTRACR102	-	NSYTRAL102	NSYTRAB1010	
-	NSYTRAC22BL	-	-	-	NSYTRAB1020	
-	NSYTRAC162	NSYTRACR162	-	NSYTRAL162	NSYTRAB1010	
-	-	-	-	-	NSYTRAB1020	
-	NSYTRAC22	NSYTRACR22	NSYTRACR22	-	-	
-	NSYTRAC23	NSYTRACR23	NSYTRACR23	-	-	
-	NSYTRAC24	NSYTRACR24	NSYTRACR24	-	-	
-	NSYTRAC22	NSYTRACR42	NSYTRACR42	-	-	
-	NSYTRAC23	NSYTRACR43	NSYTRACP43	-	-	
-	NSYTRAC24	NSYTRACR44	NSYTRACP44	-	-	
-	NSYTRAC22	NSYTRACR62	-	-	-	
-	NSYTRAC22	NSYTRACR102	-	-	-	
-	NSYTRAC162	NSYTRACR162	-	-	-	
-	NSYTRAC23	NSYTRACR23	NSYTRACPK22	-	-	
-	NSYTRAC23	-	-	-	-	
-	-	NSYTRACR24	NSYTRACPK23	-	-	
-	-	-	-	-	-	
-	NSYTRACED24	Included	-	-	-	
-	Included	-	-	-	-	
-	Included	-	-	-	-	
-	Included	-	-	-	-	
-	Included	Included	NSYTRACR42	-	-	
-	NSYTRACT22	-	-	-	-	
-	NSYTRACT22	-	-	-	-	
-	NSYTRACT22	-	-	-	-	

Cable ends compatible with all technologies	
Wires cross section area	References
0.5 mm ²	DZ5CE005
	DZ5CA005
0.75 mm ²	DZ5CE007
	DZ5CA007
1 mm ²	DZ5CE010
	DZ5CA010
1.5 mm ²	DZ5CE015
	DZ5CA015
2.5 mm ²	DZ5CE025
	DZ5CA025
4 mm ²	DZ5CE042
	DZ5CA042
6 mm ²	DZ5CE062
	DZ5CA062
10 mm ²	DZ5CE102
	DZ5CA102
16 mm ²	DZ5CE162
	DZ5CA162
25 mm ²	DZ5CE252
	DZ5CA253
35 mm ²	DZ5CE352
	DZ5CA352
50 mm ²	DZ5CE502
	DZ5CA502

DZ5CE*** = standard insulated cable ends.
DZ5CA*** = markable insulated cable ends.



Functional partitioning

Main distribution

IS Service Indices	
Presentation	H-2
Form partitioning	
Presentation	H-3
Form 1 partitioning	
Covering the supply terminals on the incoming device	H-4
Form 2 partitioning	H-5
Form 3 partitioning	H-6
Form 4 partitioning	H-7
Other partitions	H-8

IS Service Indices Presentation

What is the service index?

- The service index is a tool for characterizing the functional units of low voltage switchboards.
- It allows users to express their needs in relation to the switchboard lifecycle (operation, maintenance, evolution) to meet the requirements of their site.

How is it characterized?

- The SI is a value expressed in a three digits format (from 1 to 3) which respectively translate the level of:
 - operation,
 - maintenance,
 - and evolution of the LV switchboard
- The value 1 offers the lowest service index and the value 3 the highest service index.
- The minimum index is 111 and the maximum is 333.

Note: The service index may be different in the same switchboard, for incomers or outgoings, in order to meet the customer needs.

	1st digit Exploitation The exploitation includes all the operations on the installation likely to be carried out by personnel electrician or non-electrician.	2nd digit Maintenance Maintenance includes the maintenance operations, repair and control operations to sustain the characteristics of the switchboard. Assured by qualified personnel, they go from diagnosis to defective parts replacement.	3rd digit Upgrade Upgrade is an adaptation of the installation by adding or replacing components. Some upgrades require an interruption of the functional unit concerned: power increase, change of technology, etc. Other evolutions can be done without interruption of the functional unit: addition of outgoings, etc.
1	I accept that this operation will cause the complete shutdown of the switchboard.	I accept the complete stop of the switchboard.	I accept the complete stop of the switchboard.
2	I want this operation to result only in the complete shutdown of the only functional unit (1) concerned.	I want a limited interruption to the functional unit (1) concerned only. The refitting will be done by an intervention on the connections.	I want that the possible interruption be limited to the functional unit (1) concerned only. A stock of some predefined functional units is assured.
3	I want that this operation only stops the power of the functional unit (1) concerned, but enables automation tests that allow testing the installation in full size before restarting.	I want a limited interruption to the functional unit (1) concerned only. The refitting will be done without any intervention on the connections.	I want an operation limited to the functional unit (1) concerned, with no interruption of the switchboard. The evolution is free, within the limits imposed by the switchboard manufacturer.

(1) Functional unit: part of an assembly comprising all the mechanical and electrical components that contribute to the performance of a single feature.

Service indices achievable in PrismaSeT P Active

IS 211 Fixed	IS 231 or 232 Plug-in base	IS 331 or 332 Withdrawable on chassis	IS 223 Scalable system under power
			
			
IS 211 functional unit equipped with fixed circuit breakers	IS 231 functional unit equipped with a plug-in circuit-breaker	IS 232 reserve functional unit equipped with an empty plug-in base	IS 331 functional unit equipped with a withdrawable circuit breakers on chassis
			IS 332 reserve functional unit equipped with an empty chassis
			IS 223 possible under conditions. Consult us

Forms partitioning

Presentation

What are the forms?

- The forms are metal partitions or molded material, removable by using tools or keys, which ensure the protection of operators against direct contact with power conductors when working on low voltage switchboards.
- They also protect internal elements of the switchboard against external aggressions (dust, pests, water ...).
- These forms are graduated from 1 to 4, with indices "a" or "b". Their use contributes to the level of service continuity required by the user.
- Forms have a cumulative effect (a higher form integrates the characteristics of the forms that precede it).
- The choice of a form is the subject to an agreement between the manufacturer and the user.
- The electrical panel must comply with the degree of protection IP 2X, according to standard IEC 61439-1 & 2.

PrismaSeT P Active offers solutions for forms 1, 2a, 2b, 3a, 3b, 4a, 4b.

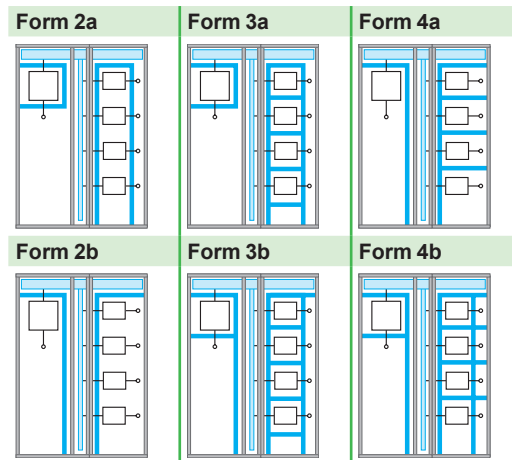

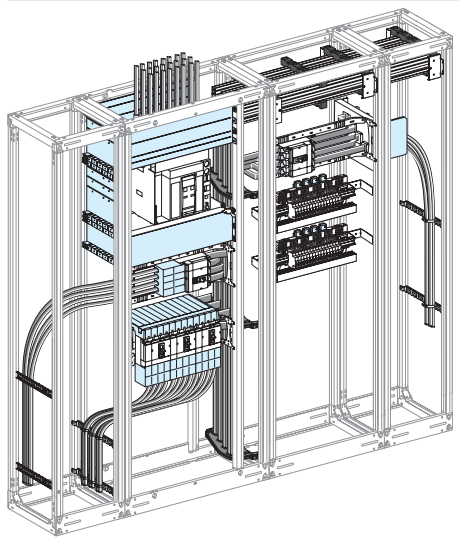
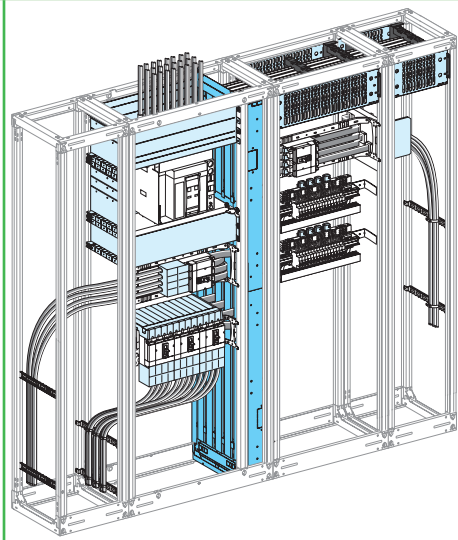
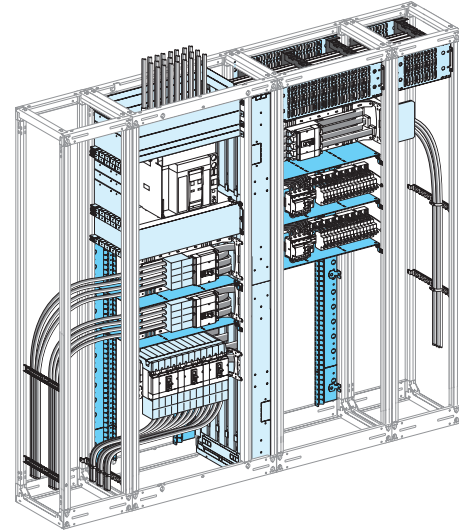
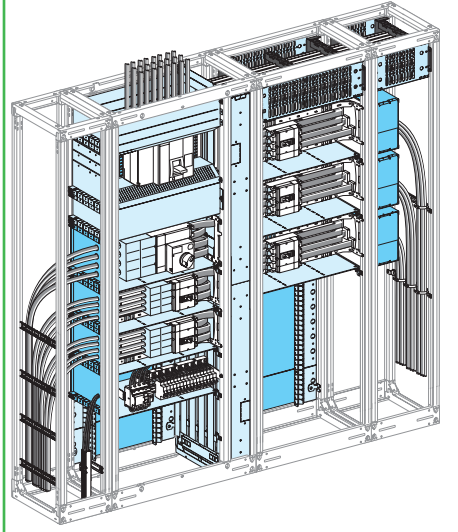
<p>Form 1 No internal separation</p> 	<p>Form 2 Separation between horizontal busbars, vertical busbars and functional units</p> 
<p>Form 3 Form 2 + separation of functional units from one another</p> 	<p>Form 4 Form 3 + separation of the terminals of the functional units from one another</p> 



Form 1 partitioning

Covering the supply terminals on the incoming device

Main distribution

		Front connection with cables				Canalis front connection			
<p>MTZ2 Only MTZ1 and ComPacT</p>		<p>D0382019.eps</p>				<p>D0382020.eps</p>			
Devices	Fixed or withdrawable device	Fixed	With-drawable	Fixed or withdrawable device	Fixed	With-drawable	Fixed or withdrawable device	Fixed	With-drawable
	MasterPacT	ComPacT		MasterPacT	ComPacT		MasterPacT	ComPacT	
	MTZ2 MTZ1	NS630b/1600	NS630b/1600	MTZ2 MTZ1	NS630b/1600	NS630b/1600	MTZ2 MTZ1	NS630b/1600	NS630b/1600
Cover	LVS04861 LVS04852	LVS04851	LVS04852	LVS04861 LVS04852	LVS04851	LVS04852	LVS04861 LVS04852	LVS04851	LVS04852
Canalis additional cover	-	-	-	LVS04871 LVS04871	LVS04871	LVS04871	LVS04871 LVS04871	LVS04871	LVS04871

		Rear connection with cables				Canalis rear connection			
<p>MTZ2 Only MTZ1 and ComPacT</p>		<p>D0382021.eps</p>				<p>D0382022.eps</p>			
Devices	Fixed or withdrawable device	Fixed	With-drawable	Fixed or withdrawable device	Fixed	With-drawable	Fixed or withdrawable device	Fixed	With-drawable
	MasterPacT	ComPacT		MasterPacT	ComPacT		MasterPacT	ComPacT	
	MTZ2 MTZ1	NS630b/1600	NS630b/1600	MTZ2 MTZ1	NS630b/1600	NS630b/1600	MTZ2 MTZ1	NS630b/1600	NS630b/1600
Cover	LVS04863 LVS04854	LVS04853	LVS04854	LVS04863 LVS04854	LVS04853	LVS04854	LVS04863 LVS04854	LVS04853	LVS04854
Canalis additional cover	-	-	-	LVS04871 LVS04871	LVS04871	LVS04871	LVS04871 LVS04871	LVS04871	LVS04871

Covering of the connection between an incoming device and lateral busbars

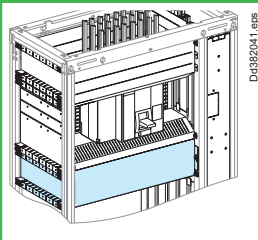

	MasterPacT MTZ2	MasterPacT MTZ1	ComPacT NS630b/1600	ComPacT NS1600b/3200 (1)	ComPacT INS-INV630b/2500
Cover with copper connection	LVS04926	LVS04926	LVS04926	LVS04926	LVS04926
Additional cover	LVS04927	-	-	-	-
Cover with Linergy LGYE connection	LVS04925	LVS04925	-	-	-
Additional cover	LVS04928	-	-	-	-
Form partition depth	600	400	400	400 (1)	400

(1) For more information > page E-14.

Note: Cubicle depth based on the depth of the incoming device.

Main distribution

Lateral partitioning

- Made of:
 - four supports that clip to the framework
 - five extruded slats that clip to the supports
 - two metal plates at the top and bottom that can be cut out to pass a PE or PEN conductor, or one or two 30 x 60 mm trunking sections
- Compliance with standard IEC 695.2.1 concerning withstand to fire.

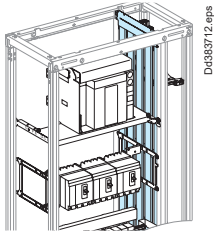
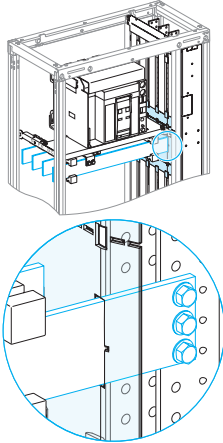
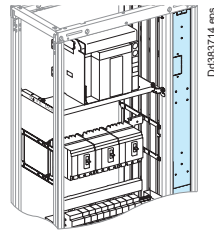
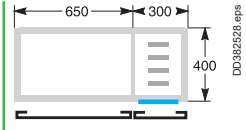
	Side barrier	Restoration kit	Front or rear barrier	
				
			W = 150 mm	W = 300 mm
Characteristics	<ul style="list-style-type: none"> ■ Vertical barrier made of insulating slats ■ can be installed on both sides of Linergy BS or Linergy LGY busbars ■ The space between the slats is sufficient for prefabricated connections (one copper bar, 5 or 10 mm thick, or insulated flexible bars) or for cables up to 35 mm², while maintaining the degree of protection IP2X 	<ul style="list-style-type: none"> ■ This kit enables passage of the connection between a device > 1600 A (MTZ2, INS-INV) and lateral vertical busbars. ■ It is made up of an insulated plate (six modules high = 300 mm) that can be cut as required, supplied with supports and the necessary hardware. ■ Has to be use with MTZ2 interlocking mounting plate 	<p>Can be installed in the front and rear of the busbar compartment. Protects against direct contact with the busbars.</p> <ul style="list-style-type: none"> ■ For 800 mm cubicles : <ul style="list-style-type: none"> □ the door is systematically supplied with a barrier. □ the cover frame is supplied with a wicket door, W = 150 mm, on which devices can be mounted. A front barrier is indispensable. ■ A barrier is required at the rear of the busbar compartment in cubicles that are 600,800 and 1000 mm deep. 	
Catalog number	LVS04922	LVS04924	LVS04921	LVS04920

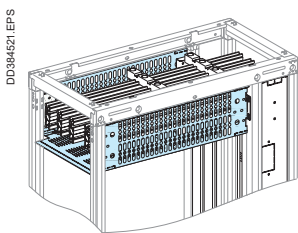

Horizontal partitioning

- Set of two barriers (front and rear), plus a slotted rear panel for efficient natural convection in the switchboard.
- The set can be used to partition horizontal busbars installed at the top or bottom of the cubicle.
- The space required for the busbars is not increased.

LVS04976

		Linergy LGYE				Linergy BS		
		Top position		Bottom position		Top position		Bottom position
	In	≤ 2500 A	≥ 3200 A	≤ 2500 A	≥ 3200 A	≤ 3200 A	4000 A	≤ 3200 A
Nb of module		3	4	3	4	3	4	3
D400								
Cover	W = 300	LVS04973	LVS04963	LVS04973 + LVS04915	LVS04963 + LVS04915	LVS04973	LVS04963	LVS04973 + LVS04915
	W = 400	LVS04974	LVS04964	LVS04974 + LVS04915	LVS04964 + LVS04915	LVS04974	LVS04964	LVS04974 + LVS04915
	W650	LVS04976	LVS04966	LVS04976 + LVS04919	LVS04966 + LVS04919	LVS04976	LVS04966	LVS04976 + LVS04919
	W650 + 150	LVS04976	LVS04966	LVS04976 + LVS04919	LVS04966 + LVS04919	LVS04976	LVS04966	LVS04976 + LVS04919
	W800	LVS04978	LVS04968	LVS04978 + LVS04919	LVS04968 + LVS04919	LVS04978	LVS04968	LVS04978 + LVS04919
D600								
Cover	W = 300	LVS04983	LVS04963	LVS04983 + LVS04915	LVS04963 + LVS04915	LVS04983	LVS04963	LVS04983 + LVS04915
	W = 400	LVS04984	LVS04964	LVS04984 + LVS04915	LVS04964 + LVS04915	LVS04984	LVS04964	LVS04984 + LVS04915
	W650	LVS04986	LVS04966	LVS04986 + LVS04919	LVS04966 + LVS04919	LVS04986	LVS04966	LVS04986 + LVS04919
	W650 + 150	LVS04986	LVS04966	LVS04986 + LVS04919	LVS04966 + LVS04919	LVS04986	LVS04966	LVS04986 + LVS04919
	W800	LVS04988	LVS04968	LVS04988 + LVS04919	LVS04968 + LVS04919	LVS04988	LVS04968	LVS04988 + LVS04919

Note: when the busbars are at the bottom of the cubicle, gland plates are mandatory > page F-19.

Note: to protect horizontal busbars installed at the bottom of the cubicle, the slotted horizontal panel must be replaced by a plain barrier.(LVS04915 or LVS04919) and add a free support LVS04662.

Form 3 partitioning

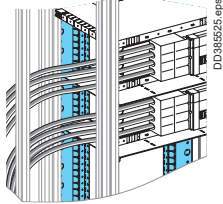
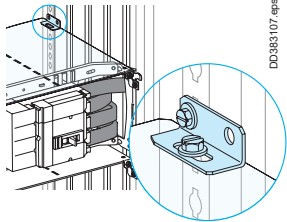
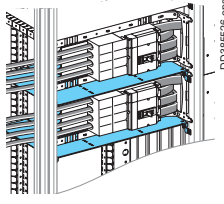
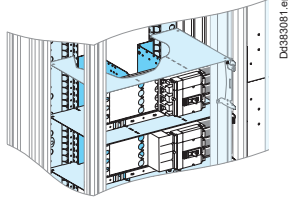
	Front connection			Rear connection	
					
	Rear support for partitions W = 650 mm	6 universal angle brackets	Horizontal metal partition W = 650 mm	Rear connection	
Characteristics	Two uprights secured to the framework (400 mm deep) or to the intermediate uprights (600 mm deep frameworks).	A set of brackets can be used to install partial Form 3 partitioning in the cubicle. It does not take up any useful space in the switchboard.	A horizontal metal partition can be used to physically separate functional units from one another. It does not take up any useful space in the switchboard.	Vertical partitions (two cat. no. per functional unit)	
Catalog numbers	LVS04943	LVS03583	LVS04901	LVS04955	LVS04956

Form 4a partitioning

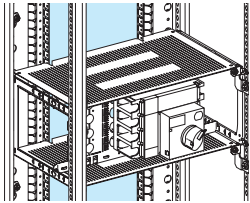
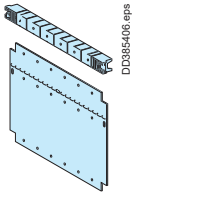
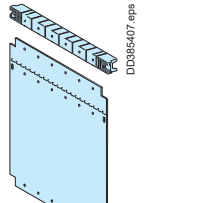
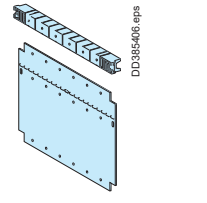
Form 4 - direct connection to the device				
Front connection		Rear connection		
				
	Backplate	Gland plate		
Characteristics	<ul style="list-style-type: none"> a backplate (one cat. no. per cubicle) made up to two metal half panels mounted on the rear supports for Form 3 partitions. This backplate is not indispensable for 400 mm deep frameworks 	<ul style="list-style-type: none"> a plastic gland plate that can be easily cut out (one for each functional unit) and is mounted on the framework. 		<ul style="list-style-type: none"> a gland plate at the rear of each functional unit. It is connected directly to the rear supports for Form 3 partitions
		3 to 4 modules	5 to 6 modules	
Catalog numbers	LVS04946	LVS04951	LVS04952	LVS04951 LVS04952

Form 4b partitioning

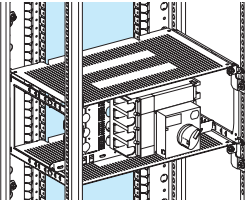
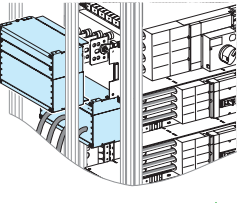
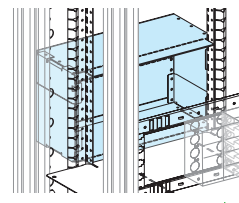
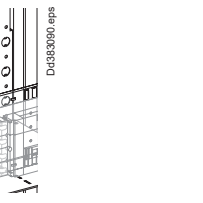
Forme 4b - connection transfer				
In a lateral compartment		At the rear of the cubicle		
				
	Backplate	Cover		
Characteristics	<ul style="list-style-type: none"> a backplate (one cat. no. per cubicle) made up to two metal half panels mounted on the rear supports for Form 3 partitions. This backplate is not indispensable for 400 mm deep frameworks 	<ul style="list-style-type: none"> a cover with plastic gland plates that can be easily cut out on the side and bottom. 		<ul style="list-style-type: none"> It comprises two height-adjustable metal flanges and plastic gland plates that can be easily cut out at the rear and bottom.
		3 to 5 modules W150	4 to 6 modules W200	3 to 5 modules 4 to 6 modules
Catalog numbers	LVS04946	LVS04953	LVS04954	LVS04953 LVS04954

Inter-cubicle partition

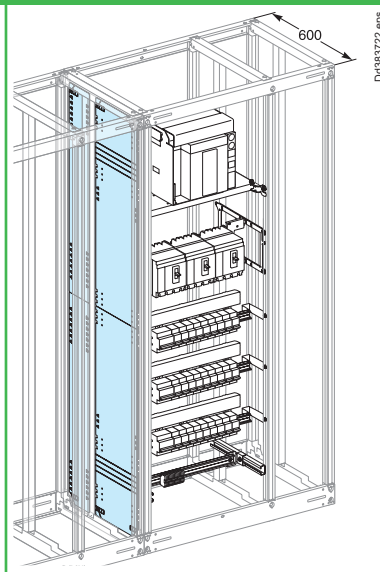
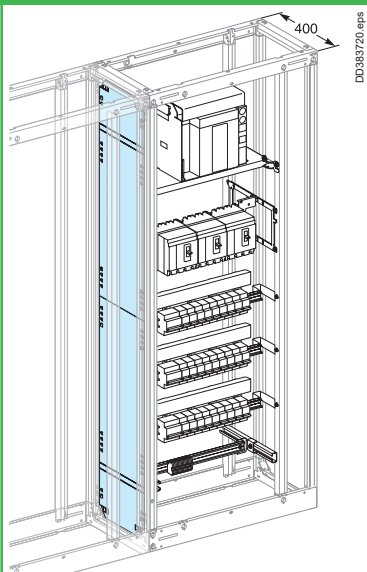

D400

D600

Characteristics

Metal partition, used to separate two adjacent cubicles.
It is made up of two panels, each 850 mm high.
The top and bottom ends have knock-outs for busbars, PE/PEN conductors or auxiliary wiring.
Supplied with the necessary supports and hardware, the partition is mounted on the framework and does not hinder installation of the functional mounting plates.

Catalog numbers

LVS04911

LVS04911 + LVS04931



Additional information

Contents

Spare parts

After-sales accessories	I-4
Optimise electrical networks	
Improving power quality	I-9
Additional equipment to optimise electrical installations	I-10

Electrical characteristics

Designing PrismaSeT P Active power circuits	
Presentation and approach	I-11
Designing horizontal busbars	
Lineryg LGYE	I-14
Lineryg BS	I-15
Designing vertical busbars	
Lineryg LGY	I-16
Lineryg LGYE	I-17
Lineryg BS	I-18
Designing rear busbars	
Lineryg LGYE, Lineryg BS	I-19
Designing connections between a device and busbars	
Prefabricated connections for ComPacT NS630b to NS1600	I-20
Prefabricated connections for MasterPacT 06-16	I-21
Prefabricated connections for ComPacT NS630b to NS1000	I-22
Fixed MasterPacT 08-16	I-23
Fixed MasterPacT 08-32	I-24
Drawout MasterPacT 08-16	I-25
Drawout MasterPacT 08-32	I-26
Designing connections between a device and busbars	
Dedicated cubicle	
Fixed MasterPacT 08-32	I-27
Drawout MasterPacT 08-32	I-28
Designing horizontal busbars	
Lineryg LGYE	I-29
Lineryg BS	I-30
Designing vertical busbars	
Lineryg LGY	I-31
Lineryg LGYE	I-32
Lineryg BS	I-33
Designing rear busbars	I-34
Designing connections between a device and busbars	
Prefabricated connections for ComPacT NS630b to NS1600	I-35
Prefabricated connections for MasterPacT 06-16	I-36
Prefabricated connections for ComPacT NS630b to NS1000	I-37
Fixed MasterPacT 08-16	I-38
Fixed MasterPacT 08-32	I-39
Drawout MasterPacT 08-16	I-40
Drawout MasterPacT 08-32	I-41

Contents

Designing connections ≤ 630 A	I-42
Device connections	I-42
ComPacT circuit breakers NSX100 to NSX630	
Insulated flexible copper bars	I-43
ComPacT circuit breakers NSX100 to NSX630	
Copper cable	I-44
ComPacT circuit breakers NSXm up to 160	
Copper cable	I-45
Designing cable connections	
Tubular lugs	I-46
Designing customer connections	
Prefabricated connections for ComPacT NS630b to NS1600	I-47
Prefabricated connections for MasterPacT 06-16	I-48
Connection transfer assembly for fixed ComPacT NS630b to NS1000	I-49
Fixed MasterPacT 08-16	I-50
Fixed MasterPacT 08-40	I-51
Drawout MasterPacT 08-16	I-52
MasterPacT 08-40 withdrawable	I-53
Fixed MasterPacT 06-16	I-54
Drawout MasterPacT 06-16	I-55
Fixed ComPacT NS1600b to NS3200	I-56
Fixed ComPacT NS630b to NS1600	I-57
Withdrawable ComPacT NS630b to NS1600	I-58
Fixed ComPacT NS630b to NS1000 Horizontal mounting	I-59
Designing busbars	
Fupact GS, ISFT, ISFL Linergy BS busbars	I-60
Fupact GS, ISFT Vertical Linergy LGYE, LGY busbars	I-61
Fupact GS, ISFT Vertical Linergy BS busbars	I-62

Enclosure characteristics

Selection of enclosures according to the premises	I-63
--	-------------

Enclosure characteristics

Designing connections between a device and busbars	
Dedicated cubicle - W = 400 mm	I-72

After-sales accessories

Spare parts

Linergy BW busbar accessories

Linergy BW accessories, 160/400 A

LVS01210

DD38463.epps



- 1 2 end plugs
- 2 2 angle brackets support
- 3 2 screws

Accessoires Linergy BW 630 A

LVS01211

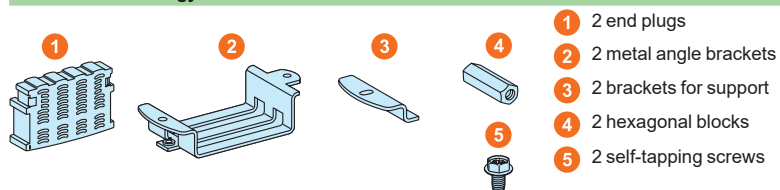

- 1 2 end plugs
- 2 2 metal angle brackets
- 3 2 brackets for support
- 4 2 hexagonal blocks
- 5 2 self-tapping screws

2 IPxxB clipon covers for Linergy BW, 160 to 400 A

LVS01201

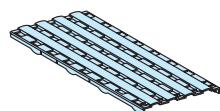

Linergy FM busbar accessories (IP30)

4 terminal covers for 200 A Linergy FM

LVS01202

DD384661.epps

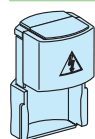

Linergy busbar accessories (IP30)

12 chocks for Linergy busbars

LVS01109

DD384674.epps

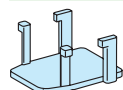

Framework accessories

Framework accessories

LVS01104

DD38462.epps

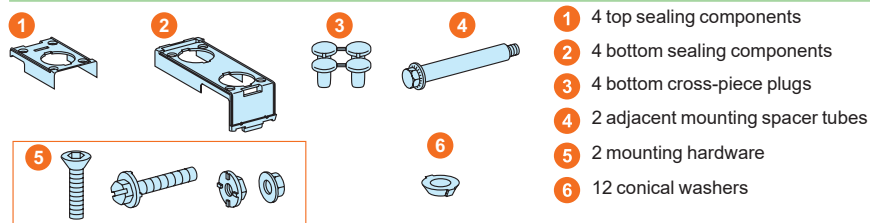

- 1 4 top sealing components
- 2 4 bottom sealing components
- 3 4 bottom cross-piece plugs
- 4 2 adjacent mounting spacer tubes
- 5 2 mounting hardware
- 6 12 conical washers

Front-plate accessories

10 sets of 2 grips quarter turn

LVS01094



DD384582.eps

Accessory

Plain wicket door, W = 150 mm

LVS01110

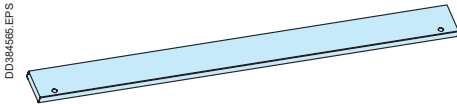

DD384565.EPS

Linergy LGYE busbar accessories

Linergy LGYE connection screwplate kit

LVS01130

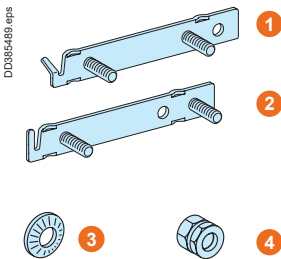

DD385488.eps

- 1 4 plates for 2000 - 4000 A joint
- 2 4 flat plates for 3200 - 4000 A connection
- 3 16 conical contact washer Ø8
- 4 16 torque nut M8

Rear accessories

Accessories IP55

LVS01101

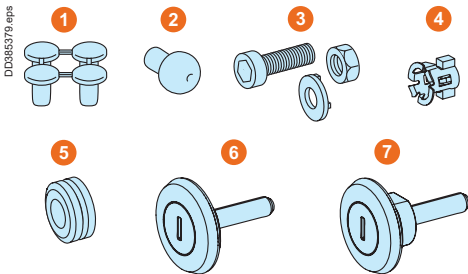

DD385379.eps

- 1 4 IP55 framework plugs
- 2 4 stop doors
- 3 base + screw + washer + nut
- 4 8 cage nuts
- 5 3 white grommet plugs
- 6 2 IP55 roof and rear panel fixing systems
- 7 6 IP55 rear panel fixing systems

Rear panel accessories

LVS01106



DD385977.eps

- 1 8 IP30 rear panel fixing systems
- 2 2 IP30 roof and rear panel fixing systems

Spare parts

Side panel accessories

Side panel accessories

LVS01100

DD385879.eps

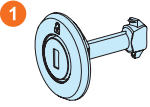

- 1 16 fixing system IP30

Accessories for IP55 side panel

LVS01102

DD384466.EPS

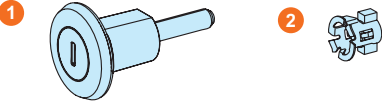

- 1 16 fixing system IP55
- 2 16 cage nuts

Accessories for IP55 roof

LVS01103

DD385306.eps

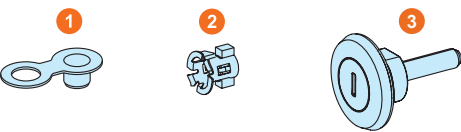

- 1 4 lifting ring plugs
- 2 6 cage nuts
- 3 6 mounting sets of screw fixing IP55 for roof

Roof accessories

Roof accessories

LVS01112

DD385878.eps



- 1 4 lifting ring plugs
- 2 6 IP30 roof and rear panel fixing systems

Front plate support frames

Front plate support striker kit for LVS08564 - LVS08566

LVS01123

DD384671.EPS

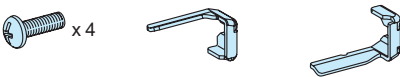

Side-by-side combination kit

PrismaSeT P Active/Prisma P Beige

PrismaSeT P Active/PrismaSeT 6300 A

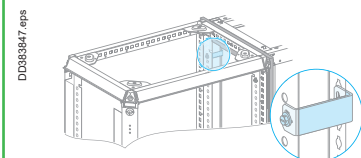
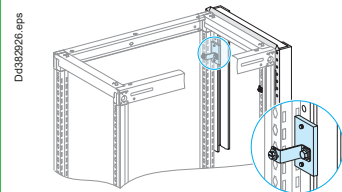

Catalog number

-

LVS01198

Characteristics

To add a PrismaSeT P Active cubicle to an existing Prisma P Beige installation, use the combination kit and a 400 mm wide frame.

PrismaSeT 6300 A/PrismaSeT P Active side-by-side combination kit

Note: When combining PrismaSeT 6300 A and PrismaSeT P Active IP55 enclosures, use the IP55 sealing kit for side-by-side combinations (LVS08717) together with the side-by-side combination kit (LVS01198).

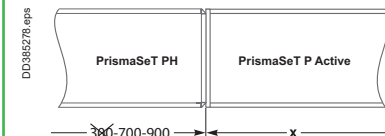
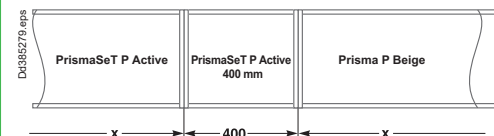

After-sales accessories

Spare parts

Framework accessories

Framework accessories

DD384572.EPS

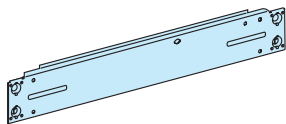

Frame bottom cross-member W650 to use with LVS08566
 Frame bottom cross-member W150+650 to use with LVS08566

LVS01120 (1)
LVS01121 (1)

(1) Spare parts on stock in RAL 9003 only.

Door accessories

Closing accessories

LVS01105

DD384617.eps

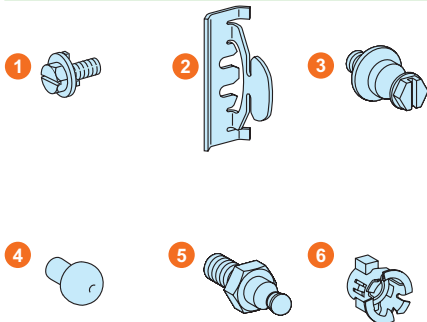

- 1 4 screws THF M6 x 16
- 2 4 door strikes
- 3 3 1/4 turn studs
- 4 2 stop doors
- 5 3 hinge pins
- 6 7 captive nuts for frame

Door strike IP30/55 Ipc Arc

LVS01124

DD436601.eps

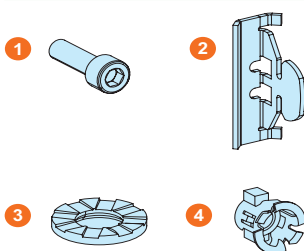

- 1 4 screws MSC HXG SK M6 x 20
- 2 4 door strike stoppers
- 3 4 washers
- 4 4 captive nuts for frame

PrismaSeT P Rotary Handle Spare Parts

LVS01219

ms231010_1.eps

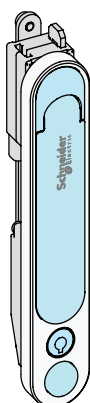

- 1 Handle housing block
- 2 P adapter link part
- 3 Screw, pan head, M5x8
- 4 The key of 405
- 5 1 crosshead screw
- 6 Omega fix part
- 7 Driver block
- 8 Hex locking screw, M6x10
- 9 Self tapping screw, pan head, ST3.5x15

After-sales accessories

Cover accessories

Cover accessories

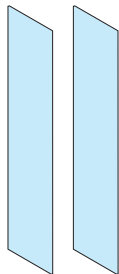

Set of 2 side panels D400 PrismaSeT P Active	LVS08755
Set of 2 side panels D600 PrismaSeT P Active	LVS08765
Set of 2 side panels D400 PrismaSeT P Active	LVS08750
Set of 2 side panels D600 PrismaSeT P	LVS08760
Green Cover W400 P for Wireless PaS	LVS01126
Green Cover W650 P for Wireless PaS	LVS01127
Green Cover W800 P for Wireless PaS	LVS01128

Connectivity accessories

Connectivity accessories

Cable Extender for LoRa Antenna	SMT10015
Cables for Wireless Panel Server 2m 3P + N	SMT10016
PrismaSeT Wireless Panel Server electronic part (without cables)	SMT10019

Optimise electrical networks

Improving power quality

Spare parts

To improve power quality, Schneider Electric proposes two power-factor correction systems, VarplusCan. Both are designed for optimum installation in PrismaSeT P Active.

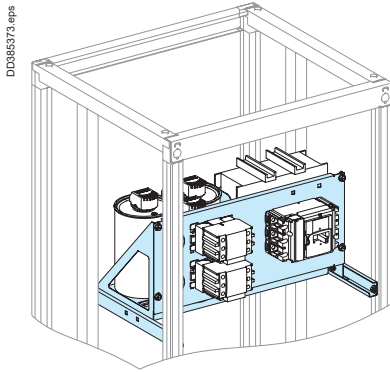

PrismaSeT P Active enclosures are designed for installation of the new VarplusCan power factor correction modules that improve the quality of the electrical distribution system and reduce consumption of reactive energy.

The modules are made up of capacitors, contactors and devices protecting against internal faults.

Installation

> [page F-21](#) for information on installation in the enclosure.

The modules can be supplied by vertical busbars, e.g. Linergy.

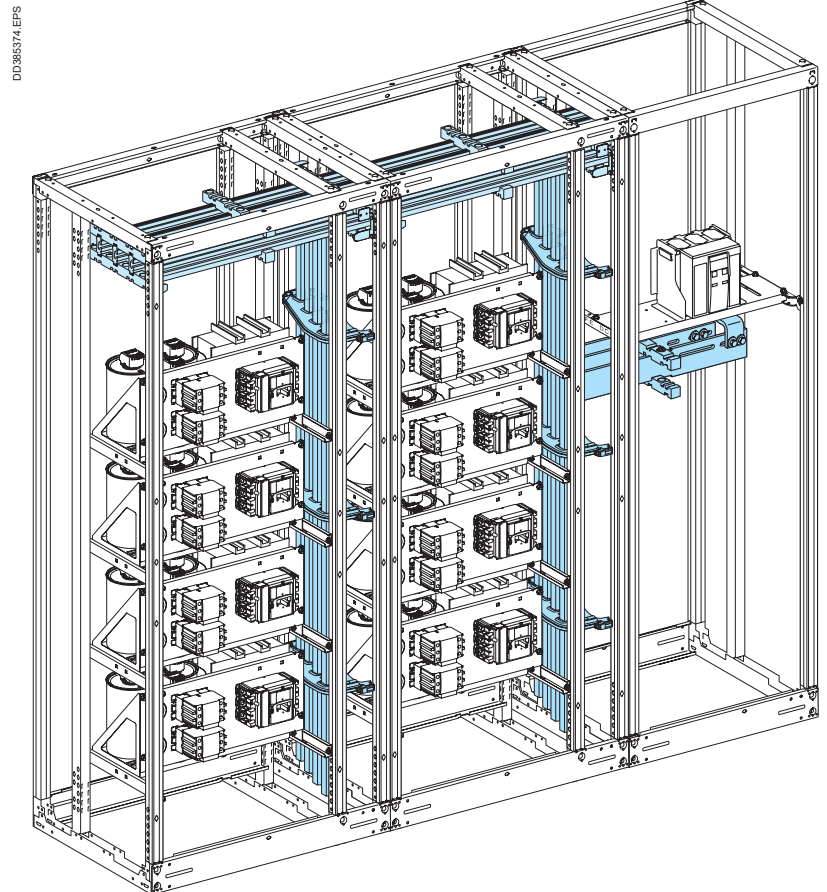

Optimise electrical networks

Additional equipment to optimise electrical installations

Spare parts

During design or during subsequent operation, electrical installations are increasingly outfitted with components designed to optimise energy consumption.

With PrismaSeT P Active, most of these products can already be added to the switchboard.

By limiting the temperature within the switchboard, it is possible to extend the life of the equipment and optimise its use.

In addition, electricity consumption is reduced because equipment in good condition has lower losses.

Heaters

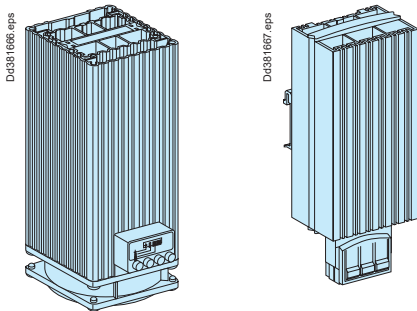

Heaters contribute to equipment optimisation by limiting condensation, corrosion and, above all, leakage currents along surfaces.

Installation and characteristics

> page F-33

Fans

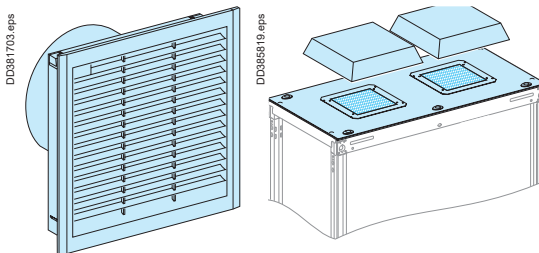

Several types of fans are available: enclosure wall or roof-mount versions. They are particularly useful for switchboards installed in temperate environments or when the degree of protection of the enclosure is high (IP55).

Installation and characteristics

> page F-32.

Thermostat

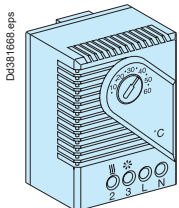

Thermostats are used to limit the temperature inside switchboards when heaters and fans are installed, thus reducing heat losses.

Installation and characteristics

> page F-34.

Installation

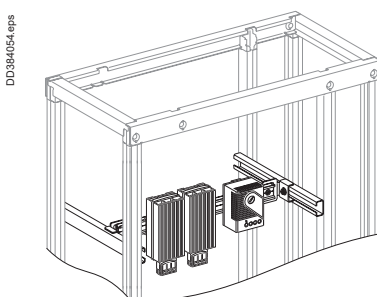

Heaters and thermostats simply clip onto a modular rail.

See Universal Enclosures catalog, cat. no. **UE12MK01EN**.

Designing PrismaSeT P Active power circuits

Presentation and approach

Electrical characteristics

PrismaSeT P Active takes into account the installation and connection conditions of Schneider Electric devices.

The entire installation complies with standard IEC 60439-1. The result is a type tested switchboard.

In the following pages you will find a number of examples, validated for PrismaSeT P Active switchboards, intended to assist in determining the busbars as well as the upstream and downstream connections for the installation.

The examples assume that the devices have already been selected.

A complete process involves a number of steps before making final choices (transformer, conductors, protection, etc.).

Schneider Electric offers a number of tools to assist in designing a complete installation (technical guides, software).

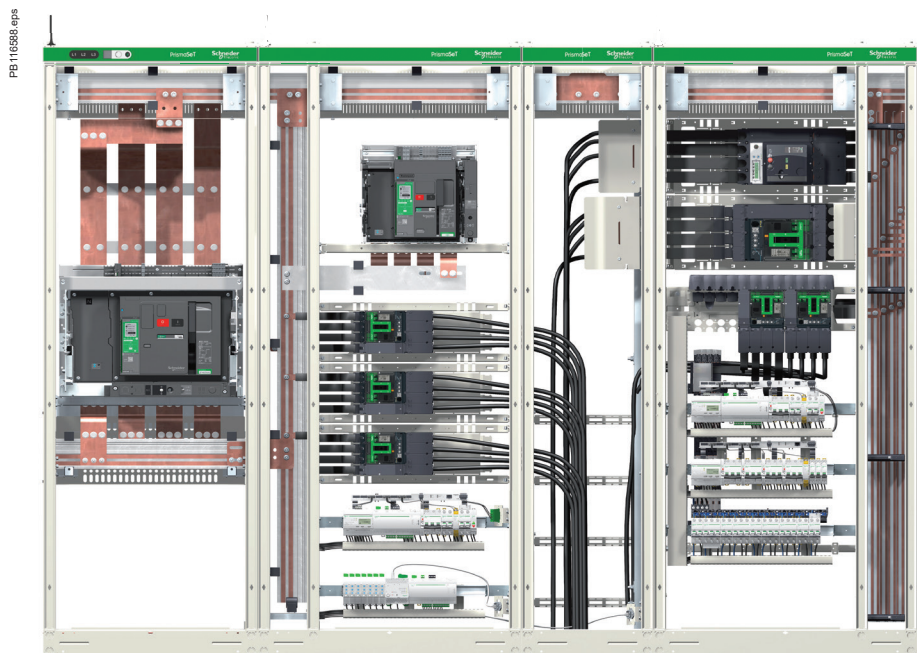

Busbar sizing

The factors that must be taken into account in determining the size of busbars include:

- the diversity factor.

Not all the loads supplied by a set of busbars are used at full rated load or at the same time. The diversity factor is the means to determine the maximum load current used to size the busbars.

Standard IEC 61439-1 and 2 §4.7 specifies the table below.

Number of circuits	Diversity factor
2 and 3	0,9
4 and 5	0,8
6 and 9	0,7
10 and more	0,6

- the degree of protection IP.
- the ambient temperature around the switchboard.

Designing PrismaSeT P Active power circuits

Presentation and approach

Electrical characteristics

Busbars

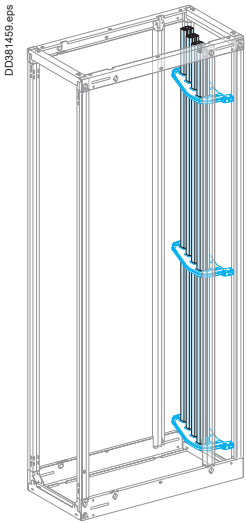

The maximum load current for a set of busbars is a function of the thermal environment.

The type and the size of the conductors must be determined in view of carrying the required currents taking into account the temperatures reached in the switchboard. These conductors are subjected to additional heat rise caused by the flowing current (joule effect) and the connected devices.

The temperatures reached by the conductors and the insulating materials, etc. must not exceed the maximum temperatures for which the products were designed. Schneider Electric busbars and distribution blocks are sized to operate without any particular constraints for the assemblies in PrismaSeT P Active switchboards operating under normal environmental conditions (standard switchboard configuration, 35 °C outside the switchboard, etc.).

To determine **Linery LGY busbars** or **Linery LGYE** required

> [pages I-14, I-16 and I-17](#).

They can be used to determine:

- the type of Linery LGY busbars or Linery LGYE, as a function of:
 - the current
 - the IP value
 - the ambient temperature around the switchboard
 - ICW/1s.

- Linery LGY busbars: $I \leq 1600$ A
- Double Linery LGY busbars: $1600 \text{ A} < I \leq 3200$ A
- Linery LGYE busbars: ≤ 4000 A.

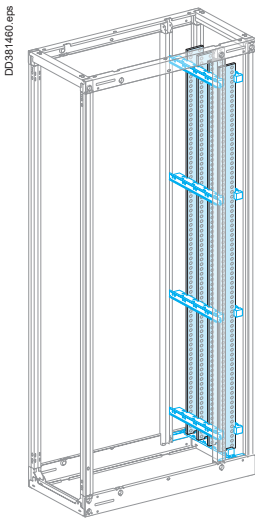

To determine the required Linery BS busbars:

horizontal busbars > [page I-15](#)

vertical busbars > [page I-18](#).

They can be used to determine:

- the permissible current as a function of:
 - the size of the busbars
 - the number of bars
 - the ambient temperature around the switchboard
 - the IP value
 - ICW/1s.

- Linery BS copper busbars 5 mm thick: $I \leq 1600$ A.
- Linery BS copper busbars 10 mm thick: $I \leq 3200$ A.

Connection of devices ≥ 630 A and busbar connections

To determine the size of upstream and downstream connections for devices > [page I-42](#).

They can be used to determine:

- the size of copper busbars
- the maximum permissible current.

As a function of:

- the type of circuit breaker
- the IP value
- the ambient temperature around the switchboard
- the type of installation.

Designing PrismaSeT P Active power circuits

Presentation and approach

Electrical characteristics

Designing the PE protective conductor

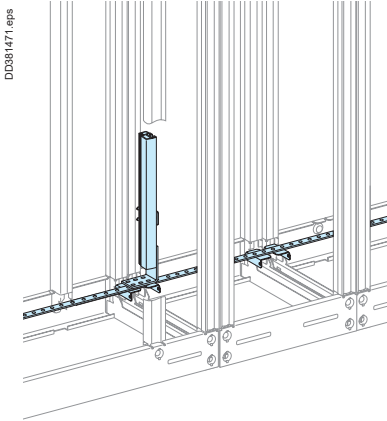

The protective conductor must be sufficiently sized and securely installed in the switchboard to accept the thermal and electrodynamic constraints of the fault current.

It must be connected to the exposed conductive parts of the switchboard. It must be accessible to enable connections both in the factory and on site.

Optimised calculation method

Use the calculation equation indicated in standard IEC 61439-1 & 2:

$$S_{PE} = \frac{\sqrt{I^2 t}}{k}$$

- SPE: cross-sectional area of the PE in mm²
- I: value of the phase-to-earth fault current = 60 % of the value of the phase-to-phase fault current (IEC 61439-1 §8.2.4.2)
- t: time the fault current flows in seconds
- k: coefficient that depends on the type of metal, k = 143 for a copper conductor with PVC insulation.

Example:

- I_{sc} = 36 kA rms C the value of the phase-to-earth fault current = 60 % of the value of the phase-to-phase fault current (standard IEC 61439-1 and 2 § 8.4.3.2.3 and 10.11.5.6), i.e.: 36 x 0.6 = 21.6 kA
- maximum time delay for the control unit: 0,5 s
- k = 143 for copper conductors with PVC insulation.

The calculation is therefore:

$$S_{PE} = \frac{\sqrt{21600^2 \times 0,5}}{143} = 106,8 \text{ mm}^2$$

The PE conductor must therefore be a 25 x 5 mm bar (= 125 mm²).

Simplified method (based on the equation above)

Use the table below to determine the size of the PE conductor as a function of device short-circuit current I_{sc}.

Size of PE conductor	All Schneider Electric devices	
I _{sc} ≤ 40 kA	1 Linergy BS bar, 25 x 5 mm	
I _{sc} ≤ 65 kA	1 Linergy BS bar, 50 x 5 mm	Linergy LGY 630 - LVS04502
I _{sc} > 65 kA but < 80 kA	1 Linergy BS bar, 50 x 5 mm	Linergy LGY 800 - LVS04503
I _{sc} = 100 kA	1 Linergy BS bar, 50 x 5 mm	Linergy LGY 1000 - LVS04505

Implementing the PEN protective conductor

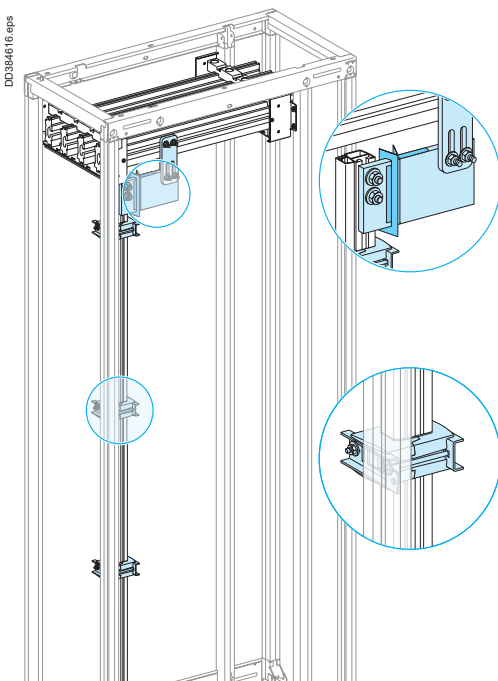

The size of the PEN is determined in the same manner as a neutral conductor, i.e.:

- for copper single-phase circuits or sized ≤ 16mm², it must be the same size as the phase conductors
- for copper three-phase circuits sized > 16 mm², it can be:
 - the same size as the phase conductors
 - smaller on the condition that:

- the current likely to flow in the neutral during normal operation is less than the permissible current for the conductor

- the power rating of single-phase loads does not exceed 10 % of the total rating.

The conductor must be accessible to enable connections both in the factory and on site, as well as checks on the tightness of connections.

Practical guidelines to install PEN

According to standard IEC 61439-1 and 2, the practical guidelines for implementing the PEN are the following:

- at the entry to the assembly, the PEN connection must be next to the phase connections
- within the assembly, the PEN does not need to be insulated from the exposed conductive parts (except on sites where there is a risk of fire or explosion)
- the size of the conductor must be at least equal to that of the neutral
- the size must remain constant throughout the main busbars
- the change from a TNC to a TNS system must take place at a single point in the switchboard, via a marked neutral-disconnection bar that is accessible and can be dismantled to facilitate the impedance measurement of the fault loop
- after the TNS creation point, it is forbidden to recreate a TNC system.

The PE and the neutral must meet their specific requirements.

Linergy LGY PEN kit

> page G-37

Designing horizontal busbars

Linery LGYE

Electrical characteristics

Permissible current and selection of Linery LGYE busbars Up to 4000 A

Linery LGYE section

Type of bars	Permissible current (A)											
	Ambient temperature around the switchboard											
	25 °C		30 °C		35 °C		40 °C		45 °C		50 °C	
Size per phase	IP ≤ 31	IP > 31	IP ≤ 31	IP > 31	IP ≤ 31	IP > 31	IP ≤ 31	IP > 31	IP ≤ 31	IP > 31	IP ≤ 31	IP > 31
Linery LGYE 630	680	580	650	550	630	530	590	500	550	470	520	■
Linery LGYE 800	860	740	830	710	800	680	750	630	700	600	660	■
Linery LGYE 1000	1080	920	1040	884	1000	850	940	790	880	750	830	■
Linery LGYE 1250	1350	1150	1300	1100	1250	1050	1170	1000	1100	930	1020	■
Linery LGYE 1600	1730	1580	1690	1530	1650	1480	1550	1380	1450	1300	1350	■
Linery LGYE 2000	2200	1810	2100	1730	2000	1650	1900	1560	1810	1480	1720	■
Linery LGYE 2500	2640	2230	2540	2160	2440	2100	2310	2000	2240	1930	2120	■
Linery LGYE 3200	3400	3020	3300	2900	3200	2800	3040	2660	2890	2520	2750	■
Linery LGYE 4000	3800	3510	3710	3430	3620	3350	3450	3180	3280	3020	3120	■

■ Connection impossible due to the operating-temperature limits of the devices installed in the switchboard.

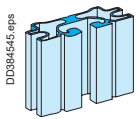

Section 630 A.
Cat. No. LVS04560.

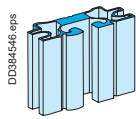

Section 800 A.
Cat. No. LVS04561.

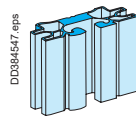

Section 1000 A.
Cat. No. LVS04562.

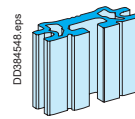

Section 1250 A.
Cat. No. LVS04563.

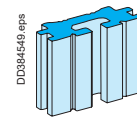

Section 1600 A.
Cat. No. LVS04564.

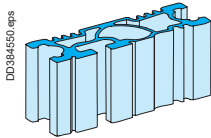

Section 2000 A.
Cat. No. LVS04565.

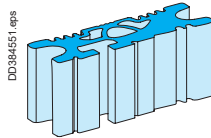

Section 2500 A.
Cat. No. LVS04566.

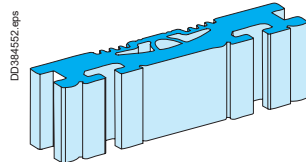

Section 3200 A.
Cat. No. LVS04567.

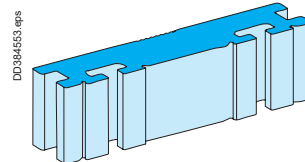

Section 4000 A.
Cat. No. LVS04568.

Designing horizontal busbars

Linery BS

Electrical characteristics

Permissible current and selection of horizontal busbar

The goal is to optimise busbar size according to the installation and operating criteria.

Up to 1600 A

Linery BS bars, 5 mm thick

Type of bars	Permissible current (A)											
	Ambient temperature around the switchboard											
	25 °C		30 °C		35 °C		40 °C		45 °C		50 °C	
Size per phase	IP ≤ 31	IP > 31	IP ≤ 31	IP > 31	IP ≤ 31	IP > 31	IP ≤ 31	IP > 31	IP ≤ 31	IP > 31	IP ≤ 31	IP > 31
1 Linery BS bar, 60 x 5	890	840	850	790	800	750	760	700	710	650	660	■
1 Linery BS bar, 80 x 5	1130	1050	1080	990	1000	900	970	870	910	810	860	■
2 Linery BS bars, 60 x 5	1580	1420	1500	1350	1400	1250	1350	1180	1260	1090	1180	■
2 Linery BS bars, 80 x 5	2010	1820	1920	1720	1800	1600	1720	1510	1610	1390	1510	■

■ Connection impossible due to the operating-temperature limits of the devices installed in the switchboard.

Up to 3200 A

Linery BS bars, 10 mm thick

Type of bars	Permissible current (A)											
	Ambient temperature around the switchboard											
	25 °C		30 °C		35 °C		40 °C		45 °C		50 °C	
Size per phase	IP ≤ 31	IP > 31	IP ≤ 31	IP > 31	IP ≤ 31	IP > 31	IP ≤ 31	IP > 31	IP ≤ 31	IP > 31	IP ≤ 31	IP > 31
1 Linery BS bar, 50 x 10	1330	1220	1260	1160	1200	1080	1130	1010	1060	940	990	■
1 Linery BS bar, 60 x 10	1550	1400	1470	1320	1400	1250	1320	1160	1240	1070	1160	■
1 Linery BS bar, 80 x 10	1990	1800	1890	1700	1800	1600	1700	1500	1600	1390	1500	■
2 Linery BS bars, 50 x 10	2270	2090	2160	1980	2050	1850	1930	1740	1810	1610	1690	■
2 Linery BS bars, 60 x 10	2550	2270	2420	2140	2300	2000	2170	1870	2030	1720	1900	■
2 Linery BS bars, 80 x 10	3110	2820	2970	2660	2820	2500	2660	2330	2500	2160	2330	■
2 Linery BS bars, 100 x 10	3650	3280	3490	3100	3300	2900	3130	2720	2950	2510	2750	■
2 Linery BS bars, 120 x 10	4160	3760	3960	3550	3760	3340	3560	3100	3340	2880	3120	■

■ Connection impossible due to the operating-temperature limits of the devices installed in the switchboard.

Example:

Two 50 x 10 mm bars can be used for a 2160 A current with an IP ≤ 31 and an ambient temperature of 30 °C around the switchboard.

Where possible, use of 10 mm bars is worthwhile in terms of the In/Isc:

■ gain in time during switchboard mounting given, where applicable, the lesser number of bars installed

■ for short-circuits, the rigidity of the bars means fewer busbar supports.

Recommendation:

Use 5 mm bars for In ≤ 1600 A and low Icw values (40 kA rms).

Use 10 mm bars for In > 1600 A and medium to high Icw values (> 40 kA rms).

Note: the values indicated above have been validated for PrismaSeT P Active switchboards.

Designing vertical busbars

Linery LGY

Electrical characteristics

Permissible current and selection of Linery LGY busbars

The goal is to optimise busbar size according to the installation and operating criteria.

Up to 3200 A

Linery LGY section

Type of bars	Permissible current (A)											
	Ambient temperature around the switchboard											
	25 °C		30 °C		35 °C		40 °C		45 °C		50 °C	
	IP ≤ 31	IP > 31	IP ≤ 31	IP > 31	IP ≤ 31	IP > 31	IP ≤ 31	IP > 31	IP ≤ 31	IP > 31	IP ≤ 31	IP > 31
Linery LGY 630	750	680	710	630	680	590	630	550	590	530	550	■
Linery LGY 800	920	840	880	800	840	760	800	720	760	680	720	■
Linery LGY 1000	1140	1040	1090	990	1040	950	990	900	950	850	900	■
Linery LGY 1250	1410	1290	1350	1230	1290	1170	1230	1100	1170	1050	1100	■
Linery LGY 1600	1800	1650	1720	1580	1650	1480	1580	1390	1480	1320	1390	■
Linery LGY 2000 (2 x 1000)	2200	2000	2100	1900	2000	1820	1900	1720	1820	1620	1720	■
Linery LGY 2500 (2 x 1250)	2740	2500	2620	2380	2500	2260	2380	2120	2260	2020	2120	■
Linery LGY 3200 (2 x 1600)	3480	3200	3340	3060	3200	2920	3060	2780	2920	2640	2780	■

■ Connection impossible due to the operating-temperature limits of the devices installed in the switchboard.

Example:

A Linery LGY channelled bar can be used for a 1650 A current with an IP ≤ 31 and an ambient temperature around the switchboard of 35 °C.

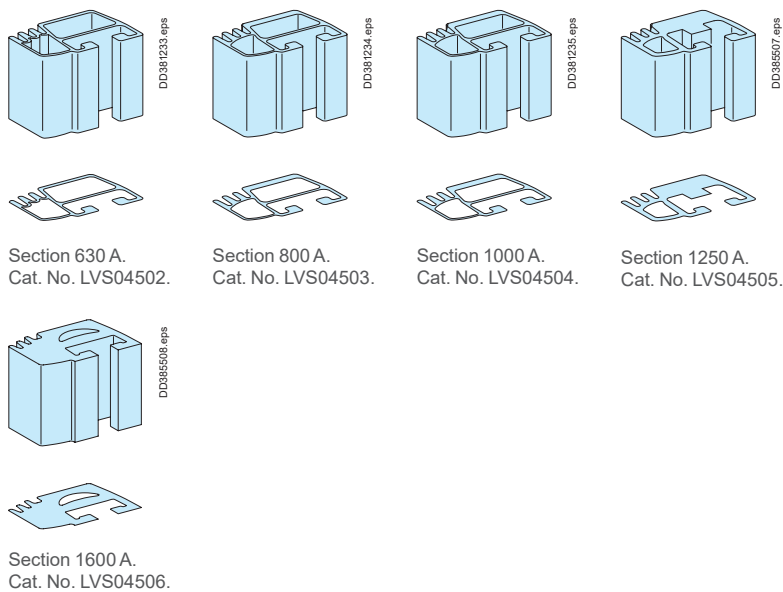

Note: the values indicated above have been validated for PrismaSeT P Active switchboards.

Designing vertical busbars

Linery LGYE

Electrical characteristics

Permissible current and selection of Linery LGYE busbars

Up to 4000 A

Linery LGYE section

Type of bars	Permissible current (A)											
	Ambient temperature around the switchboard											
	25 °C		30 °C		35 °C		40 °C		45 °C		50 °C	
Size per phase	IP ≤ 31	IP > 31	IP ≤ 31	IP > 31	IP ≤ 31	IP > 31	IP ≤ 31	IP > 31	IP ≤ 31	IP > 31	IP ≤ 31	IP > 31
Linery LGYE 630	680	580	650	550	630	530	590	500	550	470	520	■
Linery LGYE 800	860	740	830	710	800	680	750	630	700	600	660	■
Linery LGYE 1000	1080	920	1040	884	1000	850	940	790	880	750	830	■
Linery LGYE 1250	1350	1150	1300	1100	1250	1050	1170	1000	1100	930	1020	■
Linery LGYE 1600	1730	1580	1690	1530	1650	1480	1550	1380	1450	1300	1350	■
Linery LGYE 2000	2200	1810	2100	1730	2000	1650	1900	1560	1810	1480	1720	■
Linery LGYE 2500	2640	2230	2540	2160	2440	2100	2310	2000	2240	1930	2120	■
Linery LGYE 3200	3400	3020	3300	2900	3200	2800	3040	2660	2890	2520	2750	■
Linery LGYE 4000	3800	3510	3710	3430	3620	3350	3450	3180	3280	3020	3120	■

■ Connection impossible due to the operating-temperature limits of the devices installed in the switchboard.

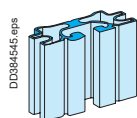

Section 630 A.
Cat. No. LVS04560.

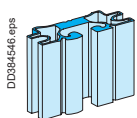

Section 800 A.
Cat. No. LVS04561.

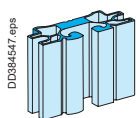

Section 1000 A.
Cat. No. LVS04562.

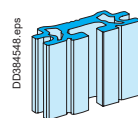

Section 1250 A.
Cat. No. LVS04563.

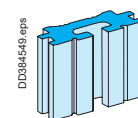

Section 1600 A.
Cat. No. LVS04564.

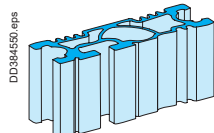

Section 2000 A.
Cat. No. LVS04565.

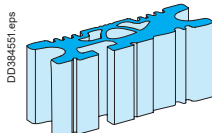

Section 2500 A.
Cat. No. LVS04566.

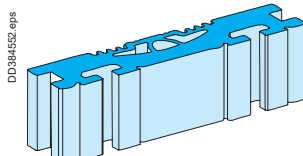

Section 3200 A.
Cat. No. LVS04567.

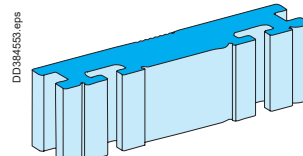

Section 4000 A.
Cat. No. LVS04568.

Designing vertical busbars

Linery BS

Electrical characteristics

Permissible current and selection of vertical busbar

The goal is to optimise busbar size according to the installation and operating criteria.

Up to 1600 A

Linery BS bars, 5 mm thick

Type of bars	Permissible current (A)											
	Ambient temperature around the switchboard											
	25 °C		30 °C		35 °C		40 °C		45 °C		50 °C	
Size per phase	IP ≤ 31	IP > 31	IP ≤ 31	IP > 31	IP ≤ 31	IP > 31	IP ≤ 31	IP > 31	IP ≤ 31	IP > 31	IP ≤ 31	IP > 31
1 Linery BS bar, 60 x 5	890	840	850	790	800	750	760	700	710	650	660	■
1 Linery BS bar, 80 x 5	1130	1050	1080	990	1000	900	970	870	910	810	860	■
2 Linery BS bars, 60 x 5	1580	1420	1500	1350	1400	1250	1350	1180	1260	1090	1180	■
2 Linery BS bars, 80 x 5	2010	1820	1920	1720	1800	1600	1720	1510	1610	1390	1510	■

■ Connection impossible due to the operating-temperature limits of the devices installed in the switchboard.

Up to 3200 A

Linery BS bars, 10 mm thick

Type of bars	Permissible current (A)											
	Ambient temperature around the switchboard											
	25 °C		30 °C		35 °C		40 °C		45 °C		50 °C	
Size per phase	IP ≤ 31	IP > 31	IP ≤ 31	IP > 31	IP ≤ 31	IP > 31	IP ≤ 31	IP > 31	IP ≤ 31	IP > 31	IP ≤ 31	IP > 31
1 Linery BS bar, 50 x 10	1330	1220	1260	1160	1200	1080	1130	1010	1060	940	990	■
1 Linery BS bar, 60 x 10	1550	1400	1470	1320	1400	1250	1320	1160	1240	1070	1160	■
1 Linery BS bar, 80 x 10	1990	1800	1890	1700	1800	1600	1700	1500	1600	1390	1500	■
1 Linery BS bar, 100 x 10	2370	2150	2260	2030	2150	1900	2030	1780	1900	1650	1780	■
2 Linery BS bars, 50 x 10	2270	2090	2160	1980	2050	1850	1930	1740	1810	1610	1690	■
2 Linery BS bars, 60 x 10	2550	2270	2420	2140	2300	2000	2170	1870	2030	1720	1900	■
2 Linery BS bars, 80 x 10	3110	2820	2970	2660	2820	2500	2660	2330	2500	2160	2330	■
2 x 1 Linery BS bar, 80 x 10	3540	3200	3370	3020	3200	2820	3020	2650	2840	2450	2650	■
2 Linery BS bars, 100 x 10	3650	3280	3490	3100	3300	2900	3130	2720	2950	2510	2750	■
2 Linery BS bars, 120 x 10	4160	3760	3960	3550	3760	3340	3560	3100	3340	2880	3120	■

■ Connection impossible due to the operating-temperature limits of the devices installed in the switchboard.

Example

Two 80 x 10 mm bars can be used for a 2820 A current with an IP ≤ 31 and an ambient temperature of 35°C around the switchboard.

Two 80 x 10 mm bars installed separately in two busbar compartments can be used for a 3200 A current with an IP ≤ 31 and an ambient temperature of 35°C around the switchboard.

Note: the values indicated above have been validated for PrismaSeT P Active switchboards.

Designing rear busbars

Linery LGYE, Linery BS

Electrical characteristics

Permissible current and selection of vertical busbar

The goal is to optimise busbar size according to the installation and operating criteria.

Up to 1600 A

Linery LGY section

Type of bars	Permissible current (A)											
	Ambient temperature around the switchboard											
	25 °C		30 °C		35 °C		40 °C		45 °C		50 °C	
	IP ≤ 31	IP > 31	IP ≤ 31	IP > 31	IP ≤ 31	IP > 31	IP ≤ 31	IP > 31	IP ≤ 31	IP > 31	IP ≤ 31	IP > 31
Linery LGY 630	750	680	710	630	680	590	630	550	590	530	550	■
Linery LGY 800	920	840	880	800	840	760	800	720	760	680	720	■
Linery LGY 1000	1140	1040	1090	990	1040	950	990	900	950	850	900	■
Linery LGY 1250	1410	1290	1350	1230	1290	1170	1230	1100	1170	1050	1100	■
Linery LGY 1600	1800	1650	1720	1580	1650	1480	1580	1390	1480	1320	1390	■

■ Connection impossible due to the operating-temperature limits of the devices installed in the switchboard.

Up to 1600 A

Linery BS bars, 5 mm thick

Type of bars	Permissible current (A)											
	Ambient temperature around the switchboard											
	25 °C		30 °C		35 °C		40 °C		45 °C		50 °C	
Size per phase	IP ≤ 31	IP > 31	IP ≤ 31	IP > 31	IP ≤ 31	IP > 31	IP ≤ 31	IP > 31	IP ≤ 31	IP > 31	IP ≤ 31	IP > 31
1 Linery BS bar, 60 x 5	890	840	850	790	800	750	760	700	710	650	660	■
1 Linery BS bar, 80 x 5	1130	1050	1080	990	1000	900	970	870	910	810	860	■
2 Linery BS bars, 60 x 5	1580	1420	1500	1350	1400	1250	1350	1180	1260	1090	1180	■
2 Linery BS bars, 80 x 5	2010	1820	1920	1720	1800	1600	1720	1510	1610	1390	1510	■

■ Connection impossible due to the operating-temperature limits of the devices installed in the switchboard.

Up to 3200 A

Linery BS bars, 10 mm thick

Type of bars	Permissible current (A)											
	Ambient temperature around the switchboard											
	25 °C		30 °C		35 °C		40 °C		45 °C		50 °C	
Size per phase	IP ≤ 31	IP > 31	IP ≤ 31	IP > 31	IP ≤ 31	IP > 31	IP ≤ 31	IP > 31	IP ≤ 31	IP > 31	IP ≤ 31	IP > 31
1 Linery BS bar, 50 x 10	1330	1220	1260	1160	1200	1080	1130	1010	1060	940	990	■
1 Linery BS bar, 60 x 10	1550	1400	1470	1320	1400	1250	1320	1160	1240	1070	1160	■
1 Linery BS bar, 80 x 10	1990	1800	1890	1700	1800	1600	1700	1500	1600	1390	1500	■
2 Linery BS bars, 80 x 10	2270	2090	2160	1980	2050	1850	1930	1740	1810	1610	1690	■
2 Linery BS bars, 60 x 10	2550	2270	2420	2140	2300	2000	2170	1870	2030	1720	1900	■
2 Linery BS bars, 80 x 10	3110	2820	2970	2660	2820	2500	2660	2330	2500	2160	2330	■

■ Connection impossible due to the operating-temperature limits of the devices installed in the switchboard.

Note: the values indicated above have been validated for PrismaSeT P Active switchboards.

Designing connections between a device and busbars

Prefabricated connections for ComPacT NS630b to NS1600

Electrical characteristics

ComPacT NS630b to NS1600 Vertical mounting

- Front or rear connection
- Top or bottom incoming
- Vertical busbars on the left or right
- Linery LGY busbars

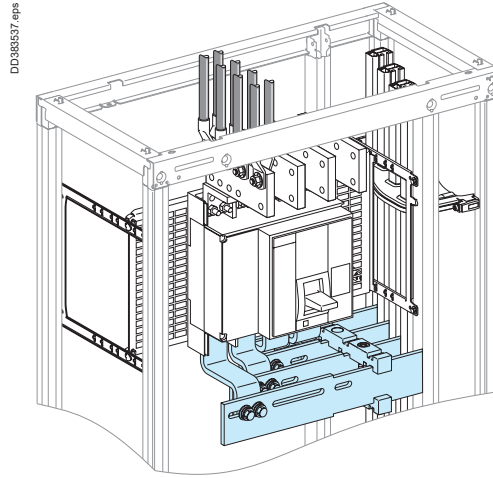

Using the data below, it is possible to determine the permissible current for a prefabricated connection between a vertical ComPacT NS630b/NS1600, fixed or withdrawable, and Linergy LGY busbars depending on the ambient temperature around the switchboard and the IP value.

Fixed

Prefabricated connection

Device and cat. no.		Permissible current (A)												
		Ambient temperature around the switchboard												
		25 °C		30 °C		35 °C		40 °C		45 °C		50 °C		
		IP ≤ 31	IP > 31	IP ≤ 31	IP > 31	IP ≤ 31	IP > 31	IP ≤ 31	IP > 31	IP ≤ 31	IP > 31	IP ≤ 31	IP > 31	
NS630b	3P cat. no. LVS04485	630	630	630	630	630	630	630	630	630	630	630	630	■
	4P cat. no. LVS04486													
NS800	3P cat. no. LVS04485	800	800	800	800	800	800	800	800	800	800	800	800	■
	4P cat. no. LVS04486													
NS1000	3P cat. no. LVS04485	1000	1000	1000	1000	1000	1000	1000	1000	1000	1000	1000	1000	■
	4P cat. no. LVS04486													
NS1250	3P cat. no. LVS04485	1250	1250	1250	1250	1250	1250	1250	1200	1250	1150	1200	■	
	4P cat. no. LVS04486													
NS1600	3P cat. no. LVS04487	1600	1550	1600	1500	1550	1450	1500	1400	1450	1350	1400	■	
	4P cat. no. LVS04488													

■ Connection impossible due to the operating-temperature limits of the devices installed in the switchboard.

Withdrawable

Prefabricated connection

Device and cat. no.		Permissible current (A)												
		Ambient temperature around the switchboard												
		25 °C		30 °C		35 °C		40 °C		45 °C		50 °C		
		IP ≤ 31	IP > 31	IP ≤ 31	IP > 31	IP ≤ 31	IP > 31	IP ≤ 31	IP > 31	IP ≤ 31	IP > 31	IP ≤ 31	IP > 31	
NS630b	3P cat. no. LVS04477	630	630	630	630	630	630	630	630	630	630	630	630	■
	4P cat. no. LVS04478													
NS800	3P cat. no. LVS04477	800	800	800	800	800	800	800	800	800	800	800	800	■
	4P cat. no. LVS04478													
NS1000	3P cat. no. LVS04477	1000	1000	1000	1000	1000	1000	1000	1000	1000	1000	1000	1000	■
	4P cat. no. LVS04478													
NS1250	3P cat. no. LVS04477	1250	1250	1250	1250	1250	1250	1250	1200	1250	1150	1200		
	4P cat. no. LVS04478													
NS1600	3P cat. no. LVS04491	1560	1480	1520	1430	1480	1380	1430	1330	1380	1280	1330	■	
	4P cat. no. LVS04492													

■ Connection impossible due to the operating-temperature limits of the devices installed in the switchboard.

Example:

For a fixed ComPacT NS1600, 4P, where the ambient temperature around the switchboard is 35°C and the IP > 31: the maximum permissible current for the prefabricated connection (LVS04488) is 1450 A.

Designing connections between a device and busbars

Prefabricated connections for MasterPacT 06-16

Electrical characteristics

MasterPact MTZ106 to 16
MasterPacT MTZ1 06 to 16
Vertical mounting

Front or rear connection
Top or bottom incoming
Vertical busbars on the left or right
Linergy LGY busbars

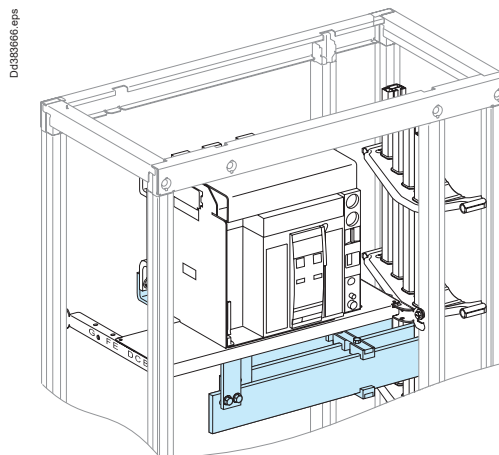

Using the data below, it is possible to determine the permissible current for a prefabricated connection between a vertical MasterPact MTZ1 06/NT16, fixed or drawout, and Linergy LGY busbars depending on the ambient temperature around the switchboard and the IP value.

Fixed

Prefabricated connection

Device and cat. no.		Permissible current (A)											
		Ambient temperature around the switchboard											
		25 °C		30 °C		35 °C		40 °C		45 °C		50 °C	
		IP ≤ 31	IP > 31	IP ≤ 31	IP > 31	IP ≤ 31	IP > 31	IP ≤ 31	IP > 31	IP ≤ 31	IP > 31	IP ≤ 31	IP > 31
NT06 & MTZ1	3P cat. no. LVS04475	630	630	630	630	630	630	630	630	630	630	630	630
	4P cat. no. LVS04476												■
NT08 & MTZ1	3P cat. no. LVS04475	800	800	800	800	800	800	800	800	800	800	800	800
	4P cat. no. LVS04476												■
NT10 & MTZ1	3P cat. no. LVS04475	1000	1000	1000	1000	1000	1000	1000	1000	1000	1000	1000	1000
	4P cat. no. LVS04476												■
NT12 & MTZ1	3P cat. no. LVS04475	1250	1250	1250	1250	1250	1250	1250	1200	1250	1150	1200	1200
	4P cat. no. LVS04476												■
NT16 & MTZ1	3P cat. no. LVS04489	1600	1570	1600	1520	1570	1470	1520	1420	1470	1370	1420	1420
	4P cat. no. LVS04490												■

■ Connection impossible due to the operating-temperature limits of the devices installed in the switchboard.

Withdrawable

Prefabricated connection

Device and cat. no.		Permissible current (A)											
		Ambient temperature around the switchboard											
		25 °C		30 °C		35 °C		40 °C		45 °C		50 °C	
		IP ≤ 31	IP > 31	IP ≤ 31	IP > 31	IP ≤ 31	IP > 31	IP ≤ 31	IP > 31	IP ≤ 31	IP > 31	IP ≤ 31	IP > 31
NT06 & MTZ1	3P cat. no. LVS04477	630	630	630	630	630	630	630	630	630	630	630	630
	4P cat. no. LVS04478												■
NT08 & MTZ1	3P cat. no. LVS04477	800	800	800	800	800	800	800	800	800	800	800	800
	4P cat. no. LVS04478												■
NT10 & MTZ1	3P cat. no. LVS04477	1000	1000	1000	1000	1000	1000	1000	1000	1000	1000	1000	1000
	4P cat. no. LVS04478												■
NT12 & MTZ1	3P cat. no. LVS04477	1250	1250	1250	1250	1250	1250	1250	1200	1250	1150	1200	1200
	4P cat. no. LVS04478												■
NT16 & MTZ1	3P cat. no. LVS04491	1560	1480	1520	1430	1480	1380	1430	1330	1380	1280	1330	1330
	4P cat. no. LVS04492												■

■ Connection impossible due to the operating-temperature limits of the devices installed in the switchboard.

Example:

For a drawout MasterPact MTZ1 16, 4P, where the ambient temperature around the switchboard is 35°C and the IP > 31: the maximum permissible current for the prefabricated connection (LVS04492) is 1380 A.

Note: the values indicated above have been validated for PrismaSeT P Active switchboards.

Designing connections between a device and busbars

Prefabricated connections for ComPacT NS630b to NS1000

Electrical characteristics

ComPacT NS630b à NS1000

Horizontal mounting

Front or rear connection

Left or right incoming

Linery LGY vertical busbars

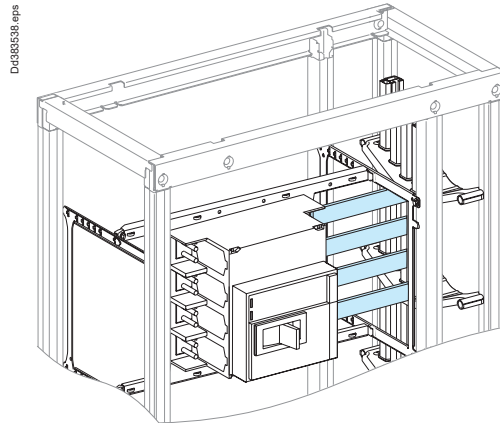

Using the data below, it is possible to determine the permissible current for a prefabricated connection between a horizontal ComPacT NS630b/NS1600, fixed or withdrawable, and Linery LGY busbars depending on the ambient temperature around the switchboard and the IP value.

Fixed

Prefabricated connection

Device and cat. no.		Permissible current (A)											
		Ambient temperature around the switchboard											
		25 °C		30 °C		35 °C		40 °C		45 °C		50 °C	
		IP ≤ 31	IP > 31	IP ≤ 31	IP > 31	IP ≤ 31	IP > 31	IP ≤ 31	IP > 31	IP ≤ 31	IP > 31	IP ≤ 31	IP > 31
NS630b	3P cat. no. LVS04473	630	630	630	630	630	630	630	630	630	630	630	■
	4P cat. no. LVS04474												
NS800	3P cat. no. LVS04473	800	800	800	800	800	800	800	800	800	800	800	■
	4P cat. no. LVS04474												
NS1000	3P cat. no. LVS04473	1000	1000	1000	1000	1000	1000	1000	1000	1000	1000	1000	■
	4P cat. no. LVS04474												

■ Connection impossible due to the operating-temperature limits of the devices installed in the switchboard.

Note: the values indicated above have been validated for PrismaSeT P Active switchboards.

Designing connections between a device and busbars

Fixed MasterPacT 08-16

Electrical characteristics

MasterPacT MTZ208 to 16
MasterPacT MTZ2 08 to 16
Fixed

Vertical busbars on the left or right
Linergy LGY, BS busbars
Connections drawings supplied by
Schneider Electric

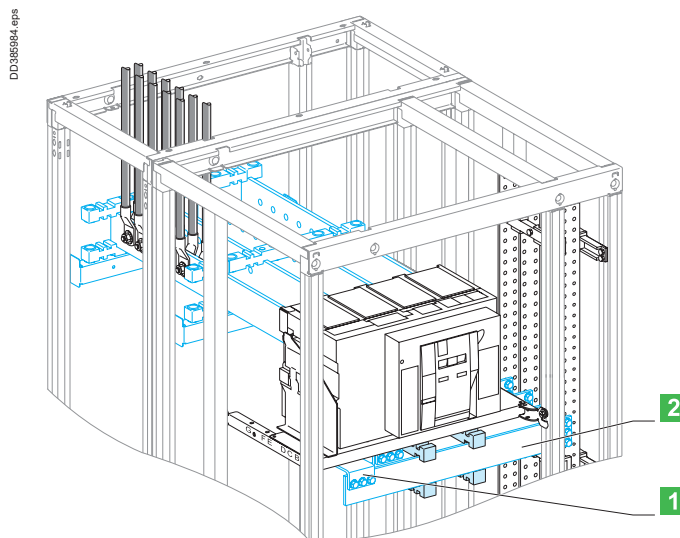

- 1** Liaison
- 2** Horizontal link.

Using the data below, it is possible to determine the size of the copper bars and the maximum permissible currents when making the connections to busbars for a vertical, fixed MasterPacT NW08/16, front or rear connection, taking into account the ambient temperature around the switchboard and the IP value.

Connection

Flat bars, 5 mm thick

Device		Permissible current (A)												
		Ambient temperature around the switchboard (1)												
		25 °C		30 °C		35 °C		40 °C		45 °C		50 °C		
		IP ≤ 31	IP > 31	IP ≤ 31	IP > 31	IP ≤ 31	IP > 31	IP ≤ 31	IP > 31	IP ≤ 31	IP > 31	IP ≤ 31	IP > 31	
NW08 & MTZ2	Size per phase	1b 80 x 5	1b 80 x 5	1b 80 x 5	1b 80 x 5	1b 80 x 5	1b 80 x 5	1b 80 x 5	1b 80 x 5	1b 80 x 5	1b 80 x 5	1b 80 x 5	1b 80 x 5	■
	I (A)	800	800	800	800	800	800	800	800	800	800	800	800	
NW10 & MTZ2	Size per phase	1b 80 x 5	1b 80 x 5	1b 80 x 5	1b 80 x 5	1b 80 x 5	1b 80 x 5	1b 80 x 5	1b 80 x 5	1b 80 x 5	1b 80 x 5	1b 80 x 5	1b 80 x 5	■
	I (A)	1000	1000	1000	1000	1000	1000	1000	1000	1000	1000	1000	1000	
NW12 & MTZ2	Size per phase	2b 80 x 5	2b 80 x 5	2b 80 x 5	2b 80 x 5	2b 80 x 5	2b 80 x 5	2b 80 x 5	2b 80 x 5	2b 80 x 5	2b 80 x 5	2b 80 x 5	2b 80 x 5	■
	I (A)	1250	1250	1250	1250	1250	1250	1250	1250	1250	1250	1250	1250	
NW16 & MTZ2	Size per phase	2b 80 x 5	2b 80 x 5	2b 80 x 5	2b 80 x 5	2b 80 x 5	2b 80 x 5	2b 80 x 5	2b 80 x 5	2b 80 x 5	2b 80 x 5	2b 80 x 5	2b 80 x 5	■
	I (A)	1600	1600	1600	1570	1600	1520	1570	1470	1520	1420	1470		

Horizontal link

Flat bars, 5 mm thick

Device		Permissible current (A)												
		Ambient temperature around the switchboard												
		25 °C		30 °C		35 °C		40 °C		45 °C		50 °C		
		IP ≤ 31	IP > 31	IP ≤ 31	IP > 31	IP ≤ 31	IP > 31	IP ≤ 31	IP > 31	IP ≤ 31	IP > 31	IP ≤ 31	IP > 31	
NW08 & MTZ2	Size per phase	1b 80 x 5	1b 80 x 5	1b 80 x 5	1b 80 x 5	1b 80 x 5	1b 80 x 5	1b 80 x 5	1b 80 x 5	1b 80 x 5	1b 80 x 5	1b 80 x 5	1b 80 x 5	■
	I (A)	800	800	800	800	800	800	800	800	800	800	800	800	
NW10 & MTZ2	Size per phase	1b 80 x 5	1b 80 x 5	1b 80 x 5	1b 80 x 5	1b 80 x 5	1b 80 x 5	1b 80 x 5	1b 80 x 5	1b 80 x 5	1b 80 x 5	1b 80 x 5	1b 80 x 5	■
	I (A)	1000	1000	1000	1000	1000	1000	1000	1000	1000	1000	1000	1000	
NW12 & MTZ2	Size per phase	2b 80 x 5	2b 80 x 5	2b 80 x 5	2b 80 x 5	2b 80 x 5	2b 80 x 5	2b 80 x 5	2b 80 x 5	2b 80 x 5	2b 80 x 5	2b 80 x 5	2b 80 x 5	■
	I (A)	1250	1250	1250	1250	1250	1250	1250	1250	1250	1250	1250	1250	
NW16 & MTZ2	Size per phase	2b 80 x 5	2b 80 x 5	2b 80 x 5	2b 80 x 5	2b 80 x 5	2b 80 x 5	2b 80 x 5	2b 80 x 5	2b 80 x 5	2b 80 x 5	2b 80 x 5	2b 80 x 5	■
	I (A)	1600	1600	1600	1570	1600	1520	1570	1470	1520	1420	1470		

■ Connection impossible due to the operating-temperature limits of the devices installed in the switchboard.

(1) In the case of a door mounted at the rear of cubicle, add 10 °C.

Note: the values indicated above have been validated for PrismaSeT P Active switchboards.

Designing connections between a device and busbars

Fixed MasterPacT 08-32

Electrical characteristics

MasterPact MTZ208 to 32 MasterPact MTZ2 08 to 32 Fixed

Vertical busbars on the left or right
Linergy LGYE, LGY, BS busbars
Connections drawings supplied by
Schneider Electric

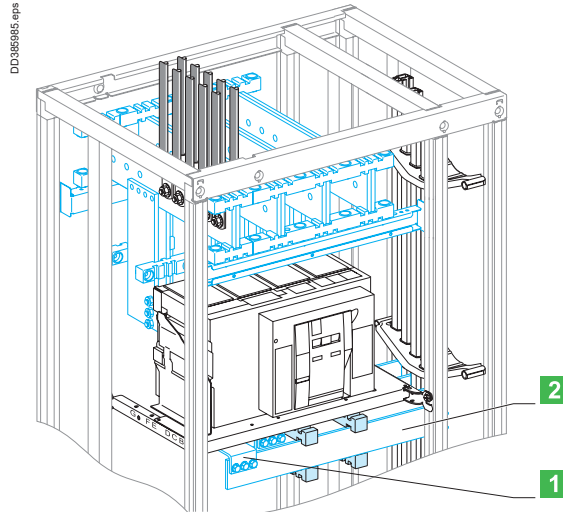

- 1** Connection.
- 2** Horizontal link.

Using the data below, it is possible to determine the size of the copper bars and the maximum permissible currents when making the connections to busbars for a vertical, fixed MasterPact MTZ2 08/32, front or rear connection, taking into account the ambient temperature around the switchboard and the IP value.

Connection

Flat bars, 10 mm thick

Device		Permissible current (A)												
		Ambient temperature around the switchboard												
		25 °C		30 °C		35 °C		40 °C		45 °C		50 °C		
		IP ≤ 31	IP > 31	IP ≤ 31	IP > 31	IP ≤ 31	IP > 31	IP ≤ 31	IP > 31	IP ≤ 31	IP > 31	IP ≤ 31	IP > 31	
NW08 & MTZ2	Size per phase	1b 80 x 10	1b 80 x 10	1b 80 x 10	1b 80 x 10	1b 80 x 10	1b 80 x 10	1b 80 x 10	1b 80 x 10	1b 80 x 10	1b 80 x 10	1b 80 x 10	1b 80 x 10	■
	I (A)	800	800	800	800	800	800	800	800	800	800	800	800	
NW10 & MTZ2	Size per phase	1b 80 x 10	1b 80 x 10	1b 80 x 10	1b 80 x 10	1b 80 x 10	1b 80 x 10	1b 80 x 10	1b 80 x 10	1b 80 x 10	1b 80 x 10	1b 80 x 10	1b 80 x 10	■
	I (A)	1000	1000	1000	1000	1000	1000	1000	1000	1000	1000	1000	1000	
NW12 & MTZ2	Size per phase	1b 80 x 10	1b 80 x 10	1b 80 x 10	1b 80 x 10	1b 80 x 10	1b 80 x 10	1b 80 x 10	1b 80 x 10	1b 80 x 10	1b 80 x 10	1b 80 x 10	1b 80 x 10	■
	I (A)	1250	1250	1250	1250	1250	1250	1250	1250	1250	1250	1250	1250	
NW16 & MTZ2	Size per phase	1b 80 x 10	1b 80 x 10	1b 80 x 10	1b 80 x 10	1b 80 x 10	1b 80 x 10	1b 80 x 10	1b 80 x 10	1b 80 x 10	1b 80 x 10	1b 80 x 10	1b 80 x 10	■
	I (A)	1600	1600	1600	1570	1600	1520	1570	1470	1520	1420	1470		
NW20 & MTZ2	Size per phase	2b 80 x 10	2b 80 x 10	2b 80 x 10	2b 80 x 10	2b 80 x 10	2b 80 x 10	2b 80 x 10	2b 80 x 10	2b 80 x 10	2b 80 x 10	2b 80 x 10	2b 80 x 10	■
	I (A)	2000	2000	2000	2000	2000	2000	2000	1950	2000	1900	1950		
NW25 & MTZ2	Size per phase	2b 80 x 10	2b 80 x 10	2b 80 x 10	2b 80 x 10	2b 80 x 10	2b 80 x 10	2b 80 x 10	2b 80 x 10	2b 80 x 10	2b 80 x 10	2b 80 x 10	2b 80 x 10	■
	I (A)	2500	2500	2500	2500	2500	2460	2500	2380	2500	2300	2460		
NW32 & MTZ2	Size per phase	3b 80 x 10	3b 80 x 10	3b 80 x 10	3b 80 x 10	3b 80 x 10	3b 80 x 10	3b 80 x 10	3b 80 x 10	3b 80 x 10	3b 80 x 10	3b 80 x 10	3b 80 x 10	■
	I (A)	3200	3000	3170	2910	3080	2820	3000	2730	2910	2630	2820		

■ Connection impossible due to the operating-temperature limits of the devices installed in the switchboard.

Horizontal link

Flat bars, 10 mm thick

Device		Permissible current (A)												
		Ambient temperature around the switchboard												
		25 °C		30 °C		35 °C		40 °C		45 °C		50 °C		
		IP ≤ 31	IP > 31	IP ≤ 31	IP > 31	IP ≤ 31	IP > 31	IP ≤ 31	IP > 31	IP ≤ 31	IP > 31	IP ≤ 31	IP > 31	
NW08 & MTZ2	Size per phase	1b 60 x 10	1b 60 x 10	1b 60 x 10	1b 60 x 10	1b 60 x 10	1b 60 x 10	1b 60 x 10	1b 60 x 10	1b 60 x 10	1b 60 x 10	1b 60 x 10	1b 60 x 10	■
	I (A)	800	800	800	800	800	800	800	800	800	800	800	800	
NW10 & MTZ2	Size per phase	1b 60 x 10	1b 60 x 10	1b 60 x 10	1b 60 x 10	1b 60 x 10	1b 60 x 10	1b 60 x 10	1b 60 x 10	1b 60 x 10	1b 60 x 10	1b 60 x 10	1b 60 x 10	■
	I (A)	1000	1000	1000	1000	1000	1000	1000	1000	1000	1000	1000	1000	
NW12 & MTZ2	Size per phase	1b 60 x 10	1b 60 x 10	1b 60 x 10	1b 60 x 10	1b 60 x 10	1b 60 x 10	1b 60 x 10	1b 60 x 10	1b 60 x 10	1b 60 x 10	1b 60 x 10	1b 60 x 10	■
	I (A)	1250	1250	1250	1250	1250	1250	1250	1250	1250	1250	1250	1250	
NW16 & MTZ2	Size per phase	1b 80 x 10	1b 80 x 10	1b 80 x 10	1b 80 x 10	1b 80 x 10	1b 80 x 10	1b 80 x 10	1b 80 x 10	1b 80 x 10	1b 80 x 10	1b 80 x 10	1b 80 x 10	■
	I (A)	1600	1600	1600	1570	1600	1520	1570	1470	1520	1420	1470		
NW20 & MTZ2	Size per phase	2b 60 x 10	2b 60 x 10	2b 60 x 10	2b 60 x 10	2b 60 x 10	2b 60 x 10	2b 60 x 10	2b 60 x 10	2b 60 x 10	2b 60 x 10	2b 60 x 10	2b 60 x 10	■
	I (A)	2000	2000	2000	2000	2000	2000	2000	1950	2000	1900	1950		
NW25 & MTZ2	Size per phase	2b 80 x 10	2b 80 x 10	2b 80 x 10	2b 80 x 10	2b 80 x 10	2b 80 x 10	2b 80 x 10	2b 80 x 10	2b 80 x 10	2b 80 x 10	2b 80 x 10	2b 80 x 10	■
	I (A)	2500	2500	2500	2500	2500	2460	2500	2380	2500	2300	2460		
NW32 & MTZ2	Size per phase	2b 100x10	2b 100x10	2b 100x10	2b 100x10	2b 100x10	2b 100x10	2b 100x10	2b 100x10	2b 100x10	2b 100x10	2b 100x10	2b 100x10	■
	I (A)	3200	3000	3170	2910	3080	2820	3000	2730	2910	2630	2820		

■ Connection impossible due to the operating-temperature limits of the devices installed in the switchboard.

Note: the values indicated above have been validated for PrismaSeT P Active switchboards.

Designing connections between a device and busbars

Drawout MasterPacT 08-16

Electrical characteristics

MasterPacT MTZ208 to 16 MasterPacT MTZ2 08 to 16 Drawout

Vertical busbars on the left or right
Linergy LGY, BS busbars
Connections drawings supplied by
Schneider Electric

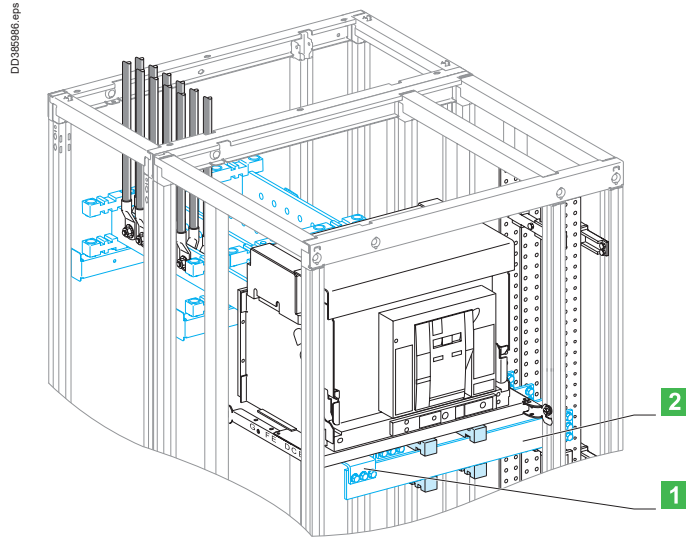

- 1** Connection.
- 2** Horizontal link.

Using the data below, it is possible to determine the size of the copper bars and the maximum permissible currents when making the connections to busbars for a vertical, drawout MasterPacT MTZ2 08/16, front or rear connection, taking into account the ambient temperature around the switchboard and the IP value.

Connection

Flat bars, 5 mm thick

Device		Permissible current (A)											
		Ambient temperature around the switchboard (1)											
		25 °C		30 °C		35 °C		40 °C		45 °C		50 °C	
		IP ≤ 31	IP > 31	IP ≤ 31	IP > 31	IP ≤ 31	IP > 31	IP ≤ 31	IP > 31	IP ≤ 31	IP > 31	IP ≤ 31	IP > 31
NW08 & MTZ2	Size per phase	1b 80 x 5	1b 80 x 5	1b 80 x 5	1b 80 x 5	1b 80 x 5	1b 80 x 5	1b 80 x 5	1b 80 x 5	1b 80 x 5	1b 80 x 5	1b 80 x 5	■
	I (A)	800	800	800	800	800	800	800	800	800	800	800	
NW10 & MTZ2	Size per phase	1b 80 x 5	1b 80 x 5	1b 80 x 5	1b 80 x 5	1b 80 x 5	1b 80 x 5	1b 80 x 5	1b 80 x 5	1b 80 x 5	1b 80 x 5	1b 80 x 5	■
	I (A)	1000	1000	1000	1000	1000	1000	1000	1000	1000	1000	1000	
NW12 & MTZ2	Size per phase	2b 80 x 5	2b 80 x 5	2b 80 x 5	2b 80 x 5	2b 80 x 5	2b 80 x 5	2b 80 x 5	2b 80 x 5	2b 80 x 5	2b 80 x 5	2b 80 x 5	■
	I (A)	1250	1250	1250	1250	1250	1230	1250	1200	1230	1160	1200	
NW16 & MTZ2	Size per phase	2b 80 x 5	2b 80 x 5	2b 80 x 5	2b 80 x 5	2b 80 x 5	2b 80 x 5	2b 80 x 5	2b 80 x 5	2b 80 x 5	2b 80 x 5	2b 80 x 5	■
	I (A)	1560	1480	1520	1430	1480	1380	1430	1330	1380	1280	1330	

■ Connection impossible due to the operating-temperature limits of the devices installed in the switchboard.

Horizontal link

Flat bars, 5 mm thick

Device		Permissible current (A)											
		Ambient temperature around the switchboard											
		25 °C		30 °C		35 °C		40 °C		45 °C		50 °C	
		IP ≤ 31	IP > 31	IP ≤ 31	IP > 31	IP ≤ 31	IP > 31	IP ≤ 31	IP > 31	IP ≤ 31	IP > 31	IP ≤ 31	IP > 31
NW08 & MTZ2	Size per phase	1b 80 x 5	1b 80 x 5	1b 80 x 5	1b 80 x 5	1b 80 x 5	1b 80 x 5	1b 80 x 5	1b 80 x 5	1b 80 x 5	1b 80 x 5	1b 80 x 5	■
	I (A)	800	800	800	800	800	800	800	800	800	800	800	
NW10 & MTZ2	Size per phase	1b 80 x 5	1b 80 x 5	1b 80 x 5	1b 80 x 5	1b 80 x 5	1b 80 x 5	1b 80 x 5	1b 80 x 5	1b 80 x 5	1b 80 x 5	1b 80 x 5	■
	I (A)	1000	1000	1000	1000	1000	1000	1000	1000	1000	1000	1000	
NW12 & MTZ2	Size per phase	2b 80 x 5	2b 80 x 5	2b 80 x 5	2b 80 x 5	2b 80 x 5	2b 80 x 5	2b 80 x 5	2b 80 x 5	2b 80 x 5	2b 80 x 5	2b 80 x 5	■
	I (A)	1250	1250	1250	1250	1250	1230	1250	1200	1230	1160	1200	
NW16 & MTZ2	Size per phase	2b 80 x 5	2b 80 x 5	2b 80 x 5	2b 80 x 5	2b 80 x 5	2b 80 x 5	2b 80 x 5	2b 80 x 5	2b 80 x 5	2b 80 x 5	2b 80 x 5	■
	I (A)	1560	1480	1520	1430	1480	1380	1430	1330	1380	1280	1330	

■ Connection impossible due to the operating-temperature limits of the devices installed in the switchboard.

(1) In the case of a door mounted at the rear of cubicle, add 10 °C.

Note: the values indicated above have been validated for PrismaSeT P Active switchboards.

Designing connections between a device and busbars

Drawout MasterPacT 08-32

Electrical characteristics

MasterPact MTZ208 to 32 MasterPacT MTZ2 08 to 32 Drawout

Vertical busbars on the left or right
Linergy LGYE, LGY, BS busbars
Connections drawings supplied by
Schneider Electric

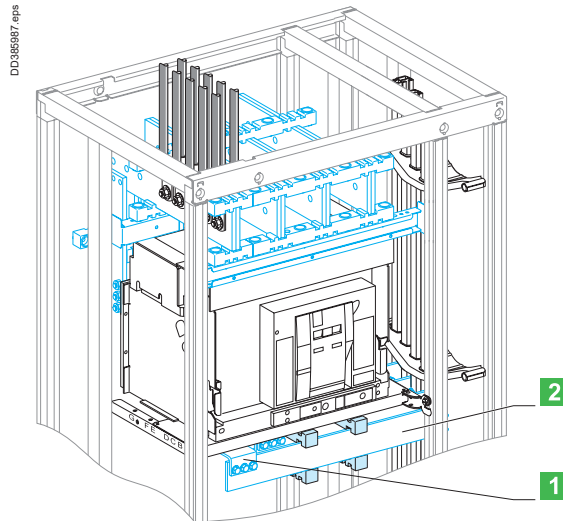

- 1** Connection.
- 2** Horizontal link.

Using the data below, it is possible to determine the size of the copper bars and the maximum permissible currents when making the connections to busbars for a vertical, drawout MasterPact MTZ2 08/32, front or rear connection, taking into account the ambient temperature around the switchboard and the IP value.

Connection

Flat bars, 10 mm thick

Device		Permissible current (A)											
		Ambient temperature around the switchboard											
		25 °C		30 °C		35 °C		40 °C		45 °C		50 °C	
		IP ≤ 31	IP > 31	IP ≤ 31	IP > 31	IP ≤ 31	IP > 31	IP ≤ 31	IP > 31	IP ≤ 31	IP > 31	IP ≤ 31	IP > 31
NW08 & MTZ2	Size per phase	1b 80 x 10	1b 80 x 10	1b 80 x 10	1b 80 x 10	1b 80 x 10	1b 80 x 10	1b 80 x 10	1b 80 x 10	1b 80 x 10	1b 80 x 10	1b 80 x 10	1b 80 x 10
	I (A)	800	800	800	800	800	800	800	800	800	800	800	■
NW10 & MTZ2	Size per phase	1b 80 x 10	1b 80 x 10	1b 80 x 10	1b 80 x 10	1b 80 x 10	1b 80 x 10	1b 80 x 10	1b 80 x 10	1b 80 x 10	1b 80 x 10	1b 80 x 10	1b 80 x 10
	I (A)	1000	1000	1000	1000	1000	1000	1000	1000	1000	1000	1000	■
NW12 & MTZ2	Size per phase	1b 80 x 10	1b 80 x 10	1b 80 x 10	1b 80 x 10	1b 80 x 10	1b 80 x 10	1b 80 x 10	1b 80 x 10	1b 80 x 10	1b 80 x 10	1b 80 x 10	1b 80 x 10
	I (A)	1250	1250	1250	1210	1250	1180	1210	1140	1180	1100	1140	■
NW16 & MTZ2	Size per phase	1b 80 x 10	1b 80 x 10	1b 80 x 10	1b 80 x 10	1b 80 x 10	1b 80 x 10	1b 80 x 10	1b 80 x 10	1b 80 x 10	1b 80 x 10	1b 80 x 10	1b 80 x 10
	I (A)	1560	1480	1520	1430	1480	1380	1430	1330	1380	1280	1330	■
NW20 & MTZ2	Size per phase	2b 80 x 10	2b 80 x 10	2b 80 x 10	2b 80 x 10	2b 80 x 10	2b 80 x 10	2b 80 x 10	2b 80 x 10	2b 80 x 10	2b 80 x 10	2b 80 x 10	2b 80 x 10
	I (A)	2000	2000	2000	1950	2000	1900	1950	1830	1900	1760	1830	■
NW25 & MTZ2	Size per phase	2b 80 x 10	2b 80 x 10	2b 80 x 10	2b 80 x 10	2b 80 x 10	2b 80 x 10	2b 80 x 10	2b 80 x 10	2b 80 x 10	2b 80 x 10	2b 80 x 10	2b 80 x 10
	I (A)	2470	2280	2410	2210	2350	2140	2280	2070	2210	2000	2140	■
NW32 & MTZ2	Size per phase	3b 80 x 10	3b 80 x 10	3b 80 x 10	3b 80 x 10	3b 80 x 10	3b 80 x 10	3b 80 x 10	3b 80 x 10	3b 80 x 10	3b 80 x 10	3b 80 x 10	3b 80 x 10
	I (A)	2960	2730	2890	2630	2820	2530	2730	2450	2630	2370	2530	■

■ Connection impossible due to the operating-temperature limits of the devices installed in the switchboard.

Horizontal link

Flat bars, 10 mm thick

Device		Permissible current (A)											
		Ambient temperature around the switchboard											
		25 °C		30 °C		35 °C		40 °C		45 °C		50 °C	
		IP ≤ 31	IP > 31	IP ≤ 31	IP > 31	IP ≤ 31	IP > 31	IP ≤ 31	IP > 31	IP ≤ 31	IP > 31	IP ≤ 31	IP > 31
NW08 & MTZ2	Size per phase	1b 60 x 10	1b 60 x 10	1b 60 x 10	1b 60 x 10	1b 60 x 10	1b 60 x 10	1b 60 x 10	1b 60 x 10	1b 60 x 10	1b 60 x 10	1b 60 x 10	1b 60 x 10
	I (A)	800	800	800	800	800	800	800	800	800	800	800	■
NW10 & MTZ2	Size per phase	1b 60 x 10	1b 60 x 10	1b 60 x 10	1b 60 x 10	1b 60 x 10	1b 60 x 10	1b 60 x 10	1b 60 x 10	1b 60 x 10	1b 60 x 10	1b 60 x 10	1b 60 x 10
	I (A)	1000	1000	1000	1000	1000	1000	1000	1000	1000	1000	1000	■
NW12 & MTZ2	Size per phase	1b 60 x 10	1b 60 x 10	1b 60 x 10	1b 60 x 10	1b 60 x 10	1b 60 x 10	1b 60 x 10	1b 60 x 10	1b 60 x 10	1b 60 x 10	1b 60 x 10	1b 60 x 10
	I (A)	1250	1250	1250	1210	1250	1180	1210	1140	1180	1100	1140	■
NW16 & MTZ2	Size per phase	1b 80 x 10	1b 80 x 10	1b 80 x 10	1b 80 x 10	1b 80 x 10	1b 80 x 10	1b 80 x 10	1b 80 x 10	1b 80 x 10	1b 80 x 10	1b 80 x 10	1b 80 x 10
	I (A)	1560	1480	1520	1430	1480	1380	1430	1330	1380	1280	1330	■
NW20 & MTZ2	Size per phase	2b 60 x 10	2b 60 x 10	2b 60 x 10	2b 60 x 10	2b 60 x 10	2b 60 x 10	2b 60 x 10	2b 60 x 10	2b 60 x 10	2b 60 x 10	2b 60 x 10	2b 60 x 10
	I (A)	2000	2000	2000	1950	2000	1900	1950	1830	1900	1760	1830	■
NW25 & MTZ2	Size per phase	2b 80 x 10	2b 80 x 10	2b 80 x 10	2b 80 x 10	2b 80 x 10	2b 80 x 10	2b 80 x 10	2b 80 x 10	2b 80 x 10	2b 80 x 10	2b 80 x 10	2b 80 x 10
	I (A)	2470	2280	2410	2210	2350	2140	2280	2070	2210	2000	2140	■
NW32 & MTZ2	Size per phase	2b 100 x 10	2b 100 x 10	2b 100 x 10	2b 100 x 10	2b 100 x 10	2b 100 x 10	2b 100 x 10	2b 100 x 10	2b 100 x 10	2b 100 x 10	2b 100 x 10	2b 100 x 10
	I (A)	2960	2730	2890	2630	2820	2530	2730	2450	2630	2370	2530	■

■ Connection impossible due to the operating-temperature limits of the devices installed in the switchboard.

Note: the values indicated above have been validated for PrismaSeT P Active switchboards.

Designing connections between a device and busbars

Dedicated cubicle

Fixed MasterPacT 08-32

Electrical characteristics

MasterPacT MTZ208 to 32
 MasterPacT MTZ2 08 to 32
 Fixed

Dedicated cubicle
 Linergy LGYE, BS busbars
 Connections drawings supplied by
 Schneider Electric

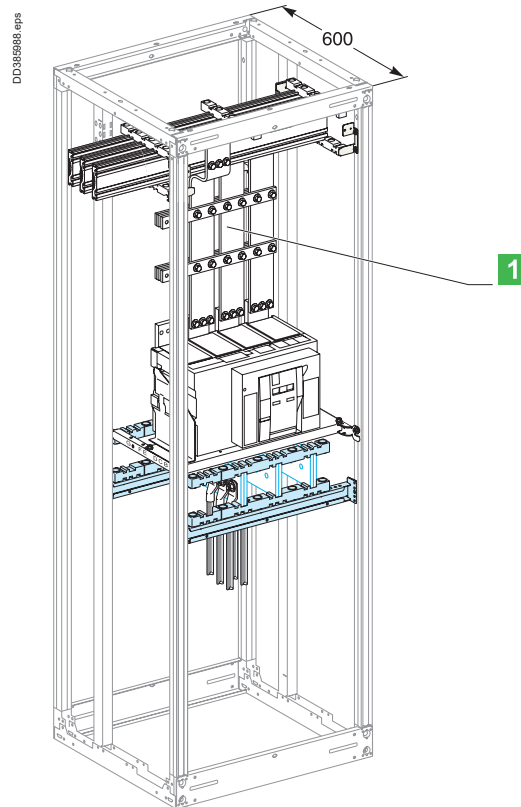

Connection

Flat bars, 10 mm thick

Device		Permissible current (A)												
		Ambient temperature around the switchboard												
		25 °C		30 °C		35 °C		40 °C		45 °C		50 °C		
		IP ≤ 31	IP > 31	IP ≤ 31	IP > 31	IP ≤ 31	IP > 31	IP ≤ 31	IP > 31	IP ≤ 31	IP > 31	IP ≤ 31	IP > 31	
NW08 & MTZ2	Size per phase	1b 80 x 10	1b 80 x 10	1b 80 x 10	1b 80 x 10	1b 80 x 10	1b 80 x 10	1b 80 x 10	1b 80 x 10	1b 80 x 10	1b 80 x 10	1b 80 x 10	1b 80 x 10	■
	I (A)	800	800	800	800	800	800	800	800	800	800	800	800	
NW10 & MTZ2	Size per phase	1b 80 x 10	1b 80 x 10	1b 80 x 10	1b 80 x 10	1b 80 x 10	1b 80 x 10	1b 80 x 10	1b 80 x 10	1b 80 x 10	1b 80 x 10	1b 80 x 10	1b 80 x 10	■
	I (A)	1000	1000	1000	1000	1000	1000	1000	1000	1000	1000	1000	1000	
NW12 & MTZ2	Size per phase	1b 80 x 10	1b 80 x 10	1b 80 x 10	1b 80 x 10	1b 80 x 10	1b 80 x 10	1b 80 x 10	1b 80 x 10	1b 80 x 10	1b 80 x 10	1b 80 x 10	1b 80 x 10	■
	I (A)	1250	1250	1250	1250	1250	1250	1250	1250	1250	1250	1250	1250	
NW16 & MTZ2	Size per phase	1b 80 x 10	1b 80 x 10	1b 80 x 10	1b 80 x 10	1b 80 x 10	1b 80 x 10	1b 80 x 10	1b 80 x 10	1b 80 x 10	1b 80 x 10	1b 80 x 10	1b 80 x 10	■
	I (A)	1600	1600	1600	1570	1600	1520	1570	1470	1520	1420	1470		
NW20 & MTZ2	Size per phase	2b 80 x 10	2b 80 x 10	2b 80 x 10	2b 80 x 10	2b 80 x 10	2b 80 x 10	2b 80 x 10	2b 80 x 10	2b 80 x 10	2b 80 x 10	2b 80 x 10	2b 80 x 10	■
	I (A)	2000	2000	2000	2000	2000	2000	2000	1950	2000	1900	1950		
NW25 & MTZ2	Size per phase	2b 80 x 10	2b 80 x 10	2b 80 x 10	2b 80 x 10	2b 80 x 10	2b 80 x 10	2b 80 x 10	2b 80 x 10	2b 80 x 10	2b 80 x 10	2b 80 x 10	2b 80 x 10	■
	I (A)	2500	2500	2500	2500	2500	2460	2500	2380	2500	2300	2460		
NW32 & MTZ2	Size per phase	3b 80 x 10	3b 80 x 10	3b 80 x 10	3b 80 x 10	3b 80 x 10	3b 80 x 10	3b 80 x 10	3b 80 x 10	3b 80 x 10	3b 80 x 10	3b 80 x 10	3b 80 x 10	■
	I (A)	3200	3000	3170	2910	3080	2820	3000	2730	2910	2630	2820		

■ Connection impossible due to the operating-temperature limits of the devices installed in the switchboard.

Note: contact Schneider Electric for 4000 A dedicated cubicle

Designing connections between a device and busbars

Dedicated cubicle

Drawout MasterPact 08-32

Electrical characteristics

MasterPact MTZ2 08 to 32

MasterPact MTZ2 08 to 32

Drawout

Dedicated cubicle

Linergy LGYE, BS busbars

Connections drawings supplied by Schneider Electric

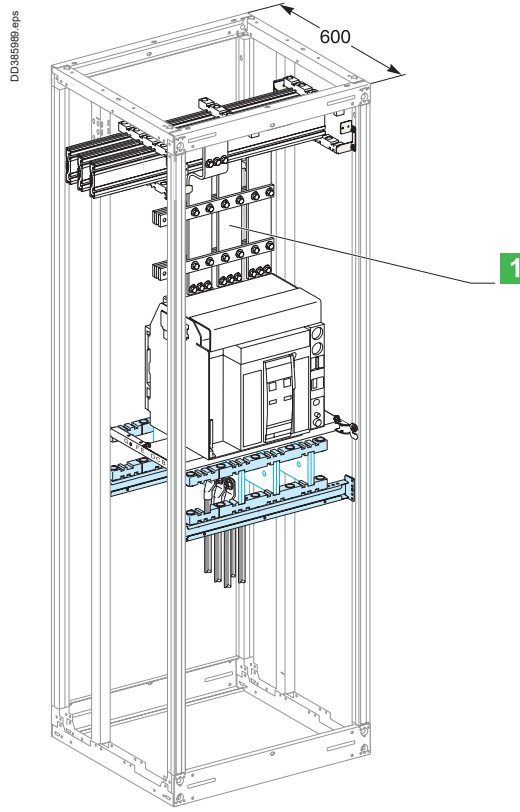

Connection

Flat bars, 10 mm thick

Device		Permissible current (A)											
		Ambient temperature around the switchboard											
		25 °C		30 °C		35 °C		40 °C		45 °C		50 °C	
		IP ≤ 31	IP > 31	IP ≤ 31	IP > 31	IP ≤ 31	IP > 31	IP ≤ 31	IP > 31	IP ≤ 31	IP > 31	IP ≤ 31	IP > 31
NW08 & MTZ2	Size per phase	1b 80 x 10	1b 80 x 10	1b 80 x 10	1b 80 x 10	1b 80 x 10	1b 80 x 10	1b 80 x 10	1b 80 x 10	1b 80 x 10	1b 80 x 10	1b 80 x 10	1b 80 x 10
	I (A)	800	800	800	800	800	800	800	800	800	800	800	800
NW10 & MTZ2	Size per phase	1b 80 x 10	1b 80 x 10	1b 80 x 10	1b 80 x 10	1b 80 x 10	1b 80 x 10	1b 80 x 10	1b 80 x 10	1b 80 x 10	1b 80 x 10	1b 80 x 10	1b 80 x 10
	I (A)	1000	1000	1000	1000	1000	1000	1000	1000	1000	1000	1000	1000
NW12 & MTZ2	Size per phase	1b 80 x 10	1b 80 x 10	1b 80 x 10	1b 80 x 10	1b 80 x 10	1b 80 x 10	1b 80 x 10	1b 80 x 10	1b 80 x 10	1b 80 x 10	1b 80 x 10	1b 80 x 10
	I (A)	1250	1250	1250	1210	1250	1180	1210	1140	1180	1100	1140	1140
NW16 & MTZ2	Size per phase	1b 80 x 10	1b 80 x 10	1b 80 x 10	1b 80 x 10	1b 80 x 10	1b 80 x 10	1b 80 x 10	1b 80 x 10	1b 80 x 10	1b 80 x 10	1b 80 x 10	1b 80 x 10
	I (A)	1560	1480	1520	1430	1480	1380	1430	1330	1380	1280	1330	1330
NW20 & MTZ2	Size per phase	2b 80 x 10	2b 80 x 10	2b 80 x 10	2b 80 x 10	2b 80 x 10	2b 80 x 10	2b 80 x 10	2b 80 x 10	2b 80 x 10	2b 80 x 10	2b 80 x 10	2b 80 x 10
	I (A)	2000	2000	2000	1950	2000	1900	1950	1830	1900	1760	1830	1830
NW25 & MTZ2	Size per phase	2b 80 x 10	2b 80 x 10	2b 80 x 10	2b 80 x 10	2b 80 x 10	2b 80 x 10	2b 80 x 10	2b 80 x 10	2b 80 x 10	2b 80 x 10	2b 80 x 10	2b 80 x 10
	I (A)	2470	2280	2410	2210	2350	2140	2280	2070	2210	2000	2140	2140
NW32 & MTZ2	Size per phase	3b 80 x 10	3b 80 x 10	3b 80 x 10	3b 80 x 10	3b 80 x 10	3b 80 x 10	3b 80 x 10	3b 80 x 10	3b 80 x 10	3b 80 x 10	3b 80 x 10	3b 80 x 10
	I (A)	2960	2730	2890	2630	2820	2530	2730	2450	2630	2370	2530	2530

■ Connection impossible due to the operating-temperature limits of the devices installed in the switchboard.

Note: contact Schneider Electric for 4000 A dedicated cubicle

Designing horizontal busbars

Linery LGYE

Electrical characteristics

Permissible current and selection of Linery LGYE busbars Up to 4000 A

Linery LGYE section

Type of bars	Permissible current (A)											
	Ambient temperature around the switchboard											
	25 °C		30 °C		35 °C		40 °C		45 °C		50 °C	
Size per phase	IP ≤ 31	IP > 31	IP ≤ 31	IP > 31	IP ≤ 31	IP > 31	IP ≤ 31	IP > 31	IP ≤ 31	IP > 31	IP ≤ 31	IP > 31
Linery LGYE 630	680	580	650	550	630	530	590	500	550	470	520	■
Linery LGYE 800	860	740	830	710	800	680	750	630	700	600	660	■
Linery LGYE 1000	1080	920	1040	884	1000	850	940	790	880	750	830	■
Linery LGYE 1250	1350	1150	1300	1100	1250	1050	1170	1000	1100	930	1020	■
Linery LGYE 1600	1730	1580	1690	1530	1650	1480	1550	1380	1450	1300	1350	■
Linery LGYE 2000	2200	1810	2100	1730	2000	1650	1900	1560	1810	1480	1720	■
Linery LGYE 2500	2640	2230	2540	2160	2440	2100	2310	2000	2240	1930	2120	■
Linery LGYE 3200	3400	3020	3300	2900	3200	2800	3040	2660	2890	2520	2750	■
Linery LGYE 4000	3800	3510	3710	3430	3620	3350	3450	3180	3280	3020	3120	■

■ Connection impossible due to the operating-temperature limits of the devices installed in the switchboard.

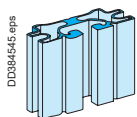

Section 630 A.
Cat. No. LVS04560.

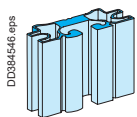

Section 800 A.
Cat. No. LVS04561.

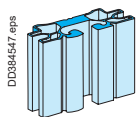

Section 1000 A.
Cat. No. LVS04562.

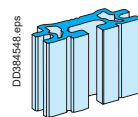

Section 1250 A.
Cat. No. LVS04563.

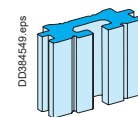

Section 1600 A.
Cat. No. LVS04564.

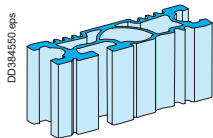

Section 2000 A.
Cat. No. LVS04565.

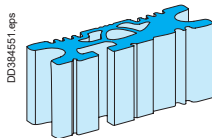

Section 2500 A.
Cat. No. LVS04566.

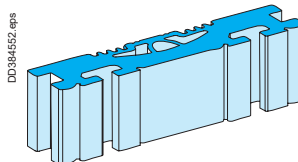

Section 3200 A.
Cat. No. LVS04567.

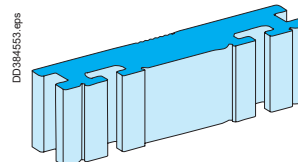

Section 4000 A.
Cat. No. LVS04568.

Designing horizontal busbars

Linery BS

Electrical characteristics

Permissible current and selection of horizontal busbar

The goal is to optimise busbar size according to the installation and operating criteria.

Up to 1600 A

Linery BS bars, 5 mm thick

Type of bars	Permissible current (A)											
	Ambient temperature around the switchboard											
	25 °C		30 °C		35 °C		40 °C		45 °C		50 °C	
Size per phase	IP ≤ 31	IP > 31	IP ≤ 31	IP > 31	IP ≤ 31	IP > 31	IP ≤ 31	IP > 31	IP ≤ 31	IP > 31	IP ≤ 31	IP > 31
1 Linery BS bar, 60 x 5	890	840	850	790	800	750	760	700	710	650	660	■
1 Linery BS bar, 80 x 5	1130	1050	1080	990	1000	900	970	870	910	810	860	■
2 Linery BS bars, 60 x 5	1580	1420	1500	1350	1400	1250	1350	1180	1260	1090	1180	■
2 Linery BS bars, 80 x 5	2010	1820	1920	1720	1800	1600	1720	1510	1610	1390	1510	■

■ Connection impossible due to the operating-temperature limits of the devices installed in the switchboard.

Up to 3200 A

Linery BS bars, 10 mm thick

Type of bars	Permissible current (A)											
	Ambient temperature around the switchboard											
	25 °C		30 °C		35 °C		40 °C		45 °C		50 °C	
Size per phase	IP ≤ 31	IP > 31	IP ≤ 31	IP > 31	IP ≤ 31	IP > 31	IP ≤ 31	IP > 31	IP ≤ 31	IP > 31	IP ≤ 31	IP > 31
1 Linery BS bar, 50 x 10	1330	1220	1260	1160	1200	1080	1130	1010	1060	940	990	■
1 Linery BS bar, 60 x 10	1550	1400	1470	1320	1400	1250	1320	1160	1240	1070	1160	■
1 Linery BS bar, 80 x 10	1990	1800	1890	1700	1800	1600	1700	1500	1600	1390	1500	■
2 Linery BS bars, 50 x 10	2270	2090	2160	1980	2050	1850	1930	1740	1810	1610	1690	■
2 Linery BS bars, 60 x 10	2550	2270	2420	2140	2300	2000	2170	1870	2030	1720	1900	■
2 Linery BS bars, 80 x 10	3110	2820	2970	2660	2820	2500	2660	2330	2500	2160	2330	■
2 Linery BS bars, 100 x 10	3650	3280	3490	3100	3300	2900	3130	2720	2950	2510	2750	■
2 Linery BS bars, 120 x 10	4160	3760	3960	3550	3760	3340	3560	3100	3340	2880	3120	■

■ Connection impossible due to the operating-temperature limits of the devices installed in the switchboard.

Example:

Two 50 x 10 mm bars can be used for a 2160 A current with an IP ≤ 31 and an ambient temperature of 30 °C around the switchboard.

Where possible, use of 10 mm bars is worthwhile in terms of the In/Isc:

■ gain in time during switchboard mounting given, where applicable, the lesser number of bars installed

■ for short-circuits, the rigidity of the bars means fewer busbar supports.

Recommendation:

Use 5 mm bars for In ≤ 1600 A and low Icw values (40 kA rms).

Use 10 mm bars for In > 1600 A and medium to high Icw values (> 40 kA rms).

Note: the values indicated above have been validated for PrismaSeT P Active switchboards.

Designing vertical busbars

Lineryg LGY

Electrical characteristics

Permissible current and selection of Lineryg LGY busbars

The goal is to optimise busbar size according to the installation and operating criteria.

Up to 3200 A

Lineryg LGY section

Type of bars	Permissible current (A)											
	Ambient temperature around the switchboard											
	25 °C		30 °C		35 °C		40 °C		45 °C		50 °C	
	IP ≤ 31	IP > 31	IP ≤ 31	IP > 31	IP ≤ 31	IP > 31	IP ≤ 31	IP > 31	IP ≤ 31	IP > 31	IP ≤ 31	IP > 31
Lineryg LGY 630	750	680	710	630	680	590	630	550	590	530	550	■
Lineryg LGY 800	920	840	880	800	840	760	800	720	760	680	720	■
Lineryg LGY 1000	1140	1040	1090	990	1040	950	990	900	950	850	900	■
Lineryg LGY 1250	1410	1290	1350	1230	1290	1170	1230	1100	1170	1050	1100	■
Lineryg LGY 1600	1800	1650	1720	1580	1650	1480	1580	1390	1480	1320	1390	■
Lineryg LGY 2000 (2 x 1000)	2200	2000	2100	1900	2000	1820	1900	1720	1820	1620	1720	■
Lineryg LGY 2500 (2 x 1250)	2740	2500	2620	2380	2500	2260	2380	2120	2260	2020	2120	■
Lineryg LGY 3200 (2 x 1600)	3480	3200	3340	3060	3200	2920	3060	2780	2920	2640	2780	■

■ Connection impossible due to the operating-temperature limits of the devices installed in the switchboard.

Example:

A Lineryg LGY channelled bar can be used for a 1650 A current with an IP ≤ 31 and an ambient temperature around the switchboard of 35 °C.

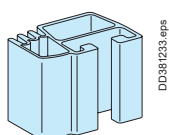

DD381233.eps

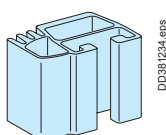

DD381234.eps

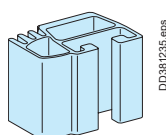

DD381235.eps

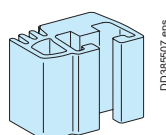

DD385507.eps



Section 630 A.
Cat. No. LVS04502.



Section 800 A.
Cat. No. LVS04503.



Section 1000 A.
Cat. No. LVS04504.



Section 1250 A.
Cat. No. LVS04505.

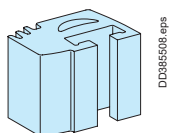

DD385508.eps



Section 1600 A.
Cat. No. LVS04506.

Note: the values indicated above have been validated for PrismaSeT P Active switchboards.

Designing vertical busbars

Linery LGYE

Electrical characteristics

Permissible current and selection of Linery LGYE busbars

Up to 4000 A

Linery LGYE section

Type of bars	Permissible current (A)											
	Ambient temperature around the switchboard											
	25 °C		30 °C		35 °C		40 °C		45 °C		50 °C	
Size per phase	IP ≤ 31	IP > 31	IP ≤ 31	IP > 31	IP ≤ 31	IP > 31	IP ≤ 31	IP > 31	IP ≤ 31	IP > 31	IP ≤ 31	IP > 31
Linery LGYE 630	680	580	650	550	630	530	590	500	550	470	520	■
Linery LGYE 800	860	740	830	710	800	680	750	630	700	600	660	■
Linery LGYE 1000	1080	920	1040	884	1000	850	940	790	880	750	830	■
Linery LGYE 1250	1350	1150	1300	1100	1250	1050	1170	1000	1100	930	1020	■
Linery LGYE 1600	1730	1580	1690	1530	1650	1480	1550	1380	1450	1300	1350	■
Linery LGYE 2000	2200	1810	2100	1730	2000	1650	1900	1560	1810	1480	1720	■
Linery LGYE 2500	2640	2230	2540	2160	2440	2100	2310	2000	2240	1930	2120	■
Linery LGYE 3200	3400	3020	3300	2900	3200	2800	3040	2660	2890	2520	2750	■
Linery LGYE 4000	3800	3510	3710	3430	3620	3350	3450	3180	3280	3020	3120	■

■ Connection impossible due to the operating-temperature limits of the devices installed in the switchboard.

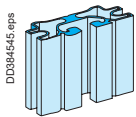

Section 630 A.
Cat. No. LVS04560.

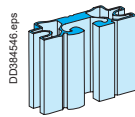

Section 800 A.
Cat. No. LVS04561.

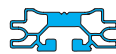
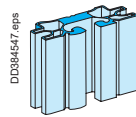

Section 1000 A.
Cat. No. LVS04562.

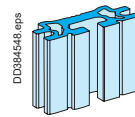

Section 1250 A.
Cat. No. LVS04563.

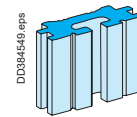

Section 1600 A.
Cat. No. LVS04564.

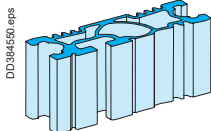

Section 2000 A.
Cat. No. LVS04565.

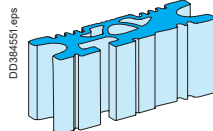

Section 2500 A.
Cat. No. LVS04566.

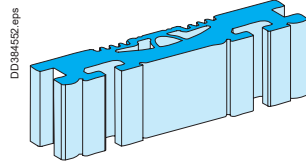

Section 3200 A.
Cat. No. LVS04567.

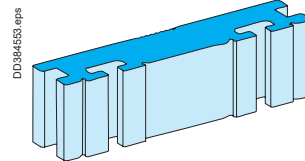

Section 4000 A.
Cat. No. LVS04568.

Designing vertical busbars

Linery BS

Electrical characteristics

Permissible current and selection of vertical busbar

The goal is to optimise busbar size according to the installation and operating criteria.

Up to 1600 A

Linery BS bars, 5 mm thick

Type of bars	Permissible current (A)											
	Ambient temperature around the switchboard											
	25 °C		30 °C		35 °C		40 °C		45 °C		50 °C	
Size per phase	IP ≤ 31	IP > 31	IP ≤ 31	IP > 31	IP ≤ 31	IP > 31	IP ≤ 31	IP > 31	IP ≤ 31	IP > 31	IP ≤ 31	IP > 31
1 Linery BS bar, 60 x 5	890	840	850	790	800	750	760	700	710	650	660	■
1 Linery BS bar, 80 x 5	1130	1050	1080	990	1000	900	970	870	910	810	860	■
2 Linery BS bars, 60 x 5	1580	1420	1500	1350	1400	1250	1350	1180	1260	1090	1180	■
2 Linery BS bars, 80 x 5	2010	1820	1920	1720	1800	1600	1720	1510	1610	1390	1510	■

■ Connection impossible due to the operating-temperature limits of the devices installed in the switchboard.

Up to 3200 A

Linery BS bars, 10 mm thick

Type of bars	Permissible current (A)											
	Ambient temperature around the switchboard											
	25 °C		30 °C		35 °C		40 °C		45 °C		50 °C	
Size per phase	IP ≤ 31	IP > 31	IP ≤ 31	IP > 31	IP ≤ 31	IP > 31	IP ≤ 31	IP > 31	IP ≤ 31	IP > 31	IP ≤ 31	IP > 31
1 Linery BS bar, 50 x 10	1330	1220	1260	1160	1200	1080	1130	1010	1060	940	990	■
1 Linery BS bar, 60 x 10	1550	1400	1470	1320	1400	1250	1320	1160	1240	1070	1160	■
1 Linery BS bar, 80 x 10	1990	1800	1890	1700	1800	1600	1700	1500	1600	1390	1500	■
1 Linery BS bar, 100 x 10	2370	2150	2260	2030	2150	1900	2030	1780	1900	1650	1780	■
2 Linery BS bars, 50 x 10	2270	2090	2160	1980	2050	1850	1930	1740	1810	1610	1690	■
2 Linery BS bars, 60 x 10	2550	2270	2420	2140	2300	2000	2170	1870	2030	1720	1900	■
2 Linery BS bars, 80 x 10	3110	2820	2970	2660	2820	2500	2660	2330	2500	2160	2330	■
2 x 1 Linery BS bar, 80 x 10	3540	3200	3370	3020	3200	2820	3020	2650	2840	2450	2650	■
2 Linery BS bars, 100 x 10	3650	3280	3490	3100	3300	2900	3130	2720	2950	2510	2750	■
2 Linery BS bars, 120 x 10	4160	3760	3960	3550	3760	3340	3560	3100	3340	2880	3120	■

■ Connection impossible due to the operating-temperature limits of the devices installed in the switchboard.

Example

Two 80 x 10 mm bars can be used for a 2820 A current with an IP ≤ 31 and an ambient temperature of 35 °C around the switchboard.

Two 80 x 10 mm bars installed separately in two busbar compartments can be used for a 3200 A current with an IP ≤ 31 and an ambient temperature of 35 °C around the switchboard.

Note: the values indicated above have been validated for PrismaSeT P Active switchboards.

Designing rear busbars

Linergy LGYE, Linergy BS

Electrical characteristics

Permissible current and selection of vertical busbar

The goal is to optimise busbar size according to the installation and operating criteria.

Up to 1600 A

Linergy LGY section

Type of bars	Permissible current (A)											
	Ambient temperature around the switchboard											
	25 °C		30 °C		35 °C		40 °C		45 °C		50 °C	
	IP ≤ 31	IP > 31	IP ≤ 31	IP > 31	IP ≤ 31	IP > 31	IP ≤ 31	IP > 31	IP ≤ 31	IP > 31	IP ≤ 31	IP > 31
Linergy LGY 630	750	680	710	630	680	590	630	550	590	530	550	■
Linergy LGY 800	920	840	880	800	840	760	800	720	760	680	720	■
Linergy LGY 1000	1140	1040	1090	990	1040	950	990	900	950	850	900	■
Linergy LGY 1250	1410	1290	1350	1230	1290	1170	1230	1100	1170	1050	1100	■
Linergy LGY 1600	1800	1650	1720	1580	1650	1480	1580	1390	1480	1320	1390	■

■ Connection impossible due to the operating-temperature limits of the devices installed in the switchboard.

Up to 1600 A

Linergy BS bars, 5 mm thick

Type of bars	Permissible current (A)											
	Ambient temperature around the switchboard											
	25 °C		30 °C		35 °C		40 °C		45 °C		50 °C	
Size per phase	IP ≤ 31	IP > 31	IP ≤ 31	IP > 31	IP ≤ 31	IP > 31	IP ≤ 31	IP > 31	IP ≤ 31	IP > 31	IP ≤ 31	IP > 31
1 Linergy BS bar, 60 x 5	890	840	850	790	800	750	760	700	710	650	660	■
1 Linergy BS bar, 80 x 5	1130	1050	1080	990	1000	900	970	870	910	810	860	■
2 Linergy BS bars, 60 x 5	1580	1420	1500	1350	1400	1250	1350	1180	1260	1090	1180	■
2 Linergy BS bars, 80 x 5	2010	1820	1920	1720	1800	1600	1720	1510	1610	1390	1510	■

■ Connection impossible due to the operating-temperature limits of the devices installed in the switchboard.

Up to 3200 A

Linergy BS bars, 10 mm thick

Type of bars	Permissible current (A)											
	Ambient temperature around the switchboard											
	25 °C		30 °C		35 °C		40 °C		45 °C		50 °C	
Size per phase	IP ≤ 31	IP > 31	IP ≤ 31	IP > 31	IP ≤ 31	IP > 31	IP ≤ 31	IP > 31	IP ≤ 31	IP > 31	IP ≤ 31	IP > 31
1 Linergy BS bar, 50 x 10	1330	1220	1260	1160	1200	1080	1130	1010	1060	940	990	■
1 Linergy BS bar, 60 x 10	1550	1400	1470	1320	1400	1250	1320	1160	1240	1070	1160	■
1 Linergy BS bar, 80 x 10	1990	1800	1890	1700	1800	1600	1700	1500	1600	1390	1500	■
2 Linergy BS bars, 80 x 10	2270	2090	2160	1980	2050	1850	1930	1740	1810	1610	1690	■
2 Linergy BS bars, 60 x 10	2550	2270	2420	2140	2300	2000	2170	1870	2030	1720	1900	■
2 Linergy BS bars, 80 x 10	3110	2820	2970	2660	2820	2500	2660	2330	2500	2160	2330	■

■ Connection impossible due to the operating-temperature limits of the devices installed in the switchboard.

Note: the values indicated above have been validated for PrismaSeT P Active switchboards.

Designing connections between a device and busbars

Prefabricated connections for ComPacT NS630b to NS1600

Electrical characteristics

ComPacT NS630b to NS1600

Vertical mounting

Front or rear connection

Top or bottom incoming

Vertical busbars on the left or right

Linery LGY busbars

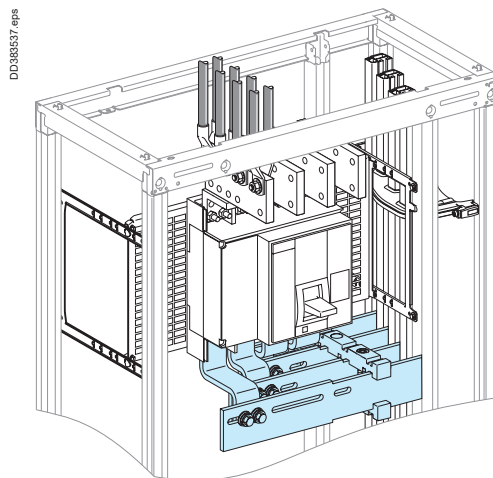

Using the data below, it is possible to determine the permissible current for a prefabricated connection between a vertical ComPacT NS630b/NS1600, fixed or withdrawable, and Linery LGY busbars depending on the ambient temperature around the switchboard and the IP value.

Fixed

Prefabricated connection

Device and cat. no.		Permissible current (A)											
		Ambient temperature around the switchboard											
		25 °C		30 °C		35 °C		40 °C		45 °C		50 °C	
		IP ≤ 31	IP > 31	IP ≤ 31	IP > 31	IP ≤ 31	IP > 31	IP ≤ 31	IP > 31	IP ≤ 31	IP > 31	IP ≤ 31	IP > 31
NS630b	3P cat. no. LVS04485	630	630	630	630	630	630	630	630	630	630	630	630
	4P cat. no. LVS04486												■
NS800	3P cat. no. LVS04485	800	800	800	800	800	800	800	800	800	800	800	800
	4P cat. no. LVS04486												■
NS1000	3P cat. no. LVS04485	1000	1000	1000	1000	1000	1000	1000	1000	1000	1000	1000	1000
	4P cat. no. LVS04486												■
NS1250	3P cat. no. LVS04485	1250	1250	1250	1250	1250	1250	1250	1200	1250	1150	1200	■
	4P cat. no. LVS04486												■
NS1600	3P cat. no. LVS04487	1600	1550	1600	1500	1550	1450	1500	1400	1450	1350	1400	■
	4P cat. no. LVS04488												■

■ Connection impossible due to the operating-temperature limits of the devices installed in the switchboard.

Withdrawable

Prefabricated connection

Device and cat. no.		Permissible current (A)											
		Ambient temperature around the switchboard											
		25 °C		30 °C		35 °C		40 °C		45 °C		50 °C	
		IP ≤ 31	IP > 31	IP ≤ 31	IP > 31	IP ≤ 31	IP > 31	IP ≤ 31	IP > 31	IP ≤ 31	IP > 31	IP ≤ 31	IP > 31
NS630b	3P cat. no. LVS04477	630	630	630	630	630	630	630	630	630	630	630	630
	4P cat. no. LVS04478												■
NS800	3P cat. no. LVS04477	800	800	800	800	800	800	800	800	800	800	800	800
	4P cat. no. LVS04478												■
NS1000	3P cat. no. LVS04477	1000	1000	1000	1000	1000	1000	1000	1000	1000	1000	1000	1000
	4P cat. no. LVS04478												■
NS1250	3P cat. no. LVS04477	1250	1250	1250	1250	1250	1250	1250	1200	1250	1150	1200	
	4P cat. no. LVS04478												
NS1600	3P cat. no. LVS04491	1560	1480	1520	1430	1480	1380	1430	1330	1380	1280	1330	■
	4P cat. no. LVS04492												■

■ Connection impossible due to the operating-temperature limits of the devices installed in the switchboard.

Example:

For a fixed ComPacT NS1600, 4P, where the ambient temperature around the switchboard is 35 °C and the IP > 31: the maximum permissible current for the prefabricated connection (LVS04488) is 1450 A.

Designing connections between a device and busbars

Prefabricated connections for MasterPacT 06-16

Electrical characteristics

MasterPact MTZ106 to 16
MasterPacT MTZ1 06 to 16

Vertical mounting

Front or rear connection

Top or bottom incoming

Vertical busbars on the left or right

Linery LGY busbars

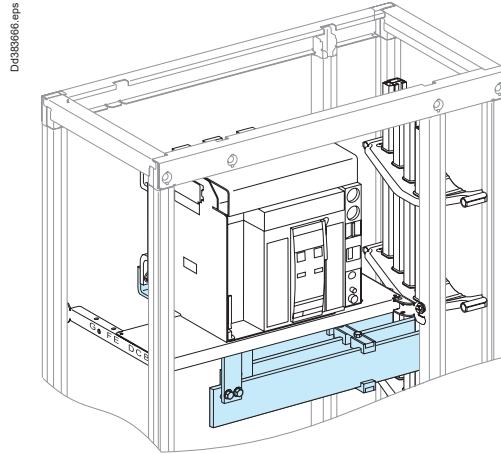

Using the data below, it is possible to determine the permissible current for a prefabricated connection between a vertical MasterPact MTZ1 06/NT16, fixed or drawout, and Linery LGY busbars depending on the ambient temperature around the switchboard and the IP value.

Fixed

Prefabricated connection

Device and cat. no.		Permissible current (A)												
		Ambient temperature around the switchboard												
		25 °C		30 °C		35 °C		40 °C		45 °C		50 °C		
		IP ≤ 31	IP > 31	IP ≤ 31	IP > 31	IP ≤ 31	IP > 31	IP ≤ 31	IP > 31	IP ≤ 31	IP > 31	IP ≤ 31	IP > 31	
NT06 & MTZ1	3P cat. no. LVS04475	630	630	630	630	630	630	630	630	630	630	630	630	■
	4P cat. no. LVS04476													
NT08 & MTZ1	3P cat. no. LVS04475	800	800	800	800	800	800	800	800	800	800	800	800	■
	4P cat. no. LVS04476													
NT10 & MTZ1	3P cat. no. LVS04475	1000	1000	1000	1000	1000	1000	1000	1000	1000	1000	1000	1000	■
	4P cat. no. LVS04476													
NT12 & MTZ1	3P cat. no. LVS04475	1250	1250	1250	1250	1250	1250	1250	1200	1250	1150	1200	1200	■
	4P cat. no. LVS04476													
NT16 & MTZ1	3P cat. no. LVS04489	1600	1570	1600	1520	1570	1470	1520	1420	1470	1370	1420	1420	■
	4P cat. no. LVS04490													

■ Connection impossible due to the operating-temperature limits of the devices installed in the switchboard.

Withdrawable

Prefabricated connection

Device and cat. no.		Permissible current (A)												
		Ambient temperature around the switchboard												
		25 °C		30 °C		35 °C		40 °C		45 °C		50 °C		
		IP ≤ 31	IP > 31	IP ≤ 31	IP > 31	IP ≤ 31	IP > 31	IP ≤ 31	IP > 31	IP ≤ 31	IP > 31	IP ≤ 31	IP > 31	
NT06 & MTZ1	3P cat. no. LVS04477	630	630	630	630	630	630	630	630	630	630	630	630	■
	4P cat. no. LVS04478													
NT08 & MTZ1	3P cat. no. LVS04477	800	800	800	800	800	800	800	800	800	800	800	800	■
	4P cat. no. LVS04478													
NT10 & MTZ1	3P cat. no. LVS04477	1000	1000	1000	1000	1000	1000	1000	1000	1000	1000	1000	1000	■
	4P cat. no. LVS04478													
NT12 & MTZ1	3P cat. no. LVS04477	1250	1250	1250	1250	1250	1250	1250	1200	1250	1150	1200	1200	■
	4P cat. no. LVS04478													
NT16 & MTZ1	3P cat. no. LVS04491	1560	1480	1520	1430	1480	1380	1430	1330	1380	1280	1330	1330	■
	4P cat. no. LVS04492													

■ Connection impossible due to the operating-temperature limits of the devices installed in the switchboard.

Example:

For a drawout MasterPact MTZ1 16 , 4P, where the ambient temperature around the switchboard is 35°C and the IP > 31: the maximum permissible current for the prefabricated connection (LVS04492) is 1380 A.

Note: the values indicated above have been validated for PrismaSeT P Active switchboards.

Designing connections between a device and busbars

Prefabricated connections for ComPacT NS630b to NS1000

Electrical characteristics

ComPacT NS630b à NS1000

Horizontal mounting

Front or rear connection

Left or right incoming

Linery LGY vertical busbars

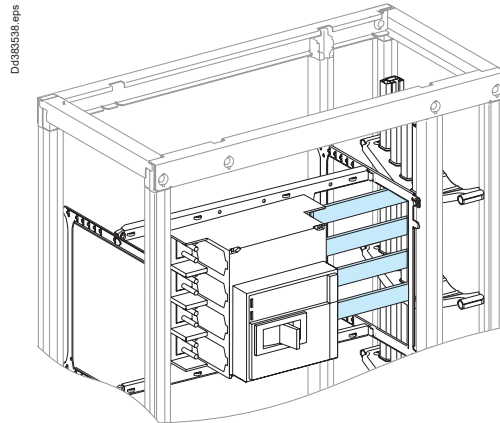

Using the data below, it is possible to determine the permissible current for a prefabricated connection between a horizontal ComPacT NS630b/NS1600, fixed or withdrawable, and Linery LGY busbars depending on the ambient temperature around the switchboard and the IP value.

Fixed

Prefabricated connection

Device and cat. no.		Permissible current (A)											
		Ambient temperature around the switchboard											
		25 °C		30 °C		35 °C		40 °C		45 °C		50 °C	
		IP ≤ 31	IP > 31	IP ≤ 31	IP > 31	IP ≤ 31	IP > 31	IP ≤ 31	IP > 31	IP ≤ 31	IP > 31	IP ≤ 31	IP > 31
NS630b	3P cat. no. LVS04473	630	630	630	630	630	630	630	630	630	630	630	■
	4P cat. no. LVS04474												
NS800	3P cat. no. LVS04473	800	800	800	800	800	800	800	800	800	800	800	■
	4P cat. no. LVS04474												
NS1000	3P cat. no. LVS04473	1000	1000	1000	1000	1000	1000	1000	1000	1000	1000	1000	■
	4P cat. no. LVS04474												

■ Connection impossible due to the operating-temperature limits of the devices installed in the switchboard.

Note: the values indicated above have been validated for PrismaSeT P Active switchboards.

Version : 14 - 15/12/2023
160E9300

Designing connections between a device and busbars

Fixed MasterPacT 08-16

Electrical characteristics

MasterPacT MTZ208 to 16
 MasterPacT MTZ2 08 to 16
 Fixed

Vertical busbars on the left or right
 Linergy LGY, BS busbars
 Connections drawings supplied by
 Schneider Electric

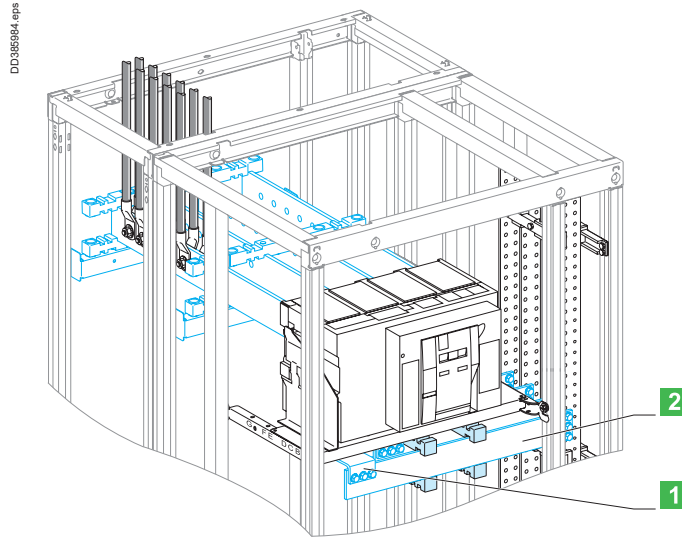

- 1** Liaison
- 2** Horizontal link.

Using the data below, it is possible to determine the size of the copper bars and the maximum permissible currents when making the connections to busbars for a vertical, fixed MasterPacT NW08/16, front or rear connection, taking into account the ambient temperature around the switchboard and the IP value.

Connection

Flat bars, 5 mm thick

Device		Permissible current (A)											
		Ambient temperature around the switchboard (1)											
		25 °C		30 °C		35 °C		40 °C		45 °C		50 °C	
		IP ≤ 31	IP > 31	IP ≤ 31	IP > 31	IP ≤ 31	IP > 31	IP ≤ 31	IP > 31	IP ≤ 31	IP > 31	IP ≤ 31	IP > 31
NW08 & MTZ2	Size per phase	1b 80 x 5	1b 80 x 5	1b 80 x 5	1b 80 x 5	1b 80 x 5	1b 80 x 5	1b 80 x 5	1b 80 x 5	1b 80 x 5	1b 80 x 5	1b 80 x 5	■
	I (A)	800	800	800	800	800	800	800	800	800	800	800	
NW10 & MTZ2	Size per phase	1b 80 x 5	1b 80 x 5	1b 80 x 5	1b 80 x 5	1b 80 x 5	1b 80 x 5	1b 80 x 5	1b 80 x 5	1b 80 x 5	1b 80 x 5	1b 80 x 5	■
	I (A)	1000	1000	1000	1000	1000	1000	1000	1000	1000	1000	1000	
NW12 & MTZ2	Size per phase	2b 80 x 5	2b 80 x 5	2b 80 x 5	2b 80 x 5	2b 80 x 5	2b 80 x 5	2b 80 x 5	2b 80 x 5	2b 80 x 5	2b 80 x 5	2b 80 x 5	■
	I (A)	1250	1250	1250	1250	1250	1250	1250	1250	1250	1250	1250	
NW16 & MTZ2	Size per phase	2b 80 x 5	2b 80 x 5	2b 80 x 5	2b 80 x 5	2b 80 x 5	2b 80 x 5	2b 80 x 5	2b 80 x 5	2b 80 x 5	2b 80 x 5	2b 80 x 5	■
	I (A)	1600	1600	1600	1570	1600	1520	1570	1470	1520	1420	1470	

Horizontal link

Flat bars, 5 mm thick

Device		Permissible current (A)											
		Ambient temperature around the switchboard											
		25 °C		30 °C		35 °C		40 °C		45 °C		50 °C	
		IP ≤ 31	IP > 31	IP ≤ 31	IP > 31	IP ≤ 31	IP > 31	IP ≤ 31	IP > 31	IP ≤ 31	IP > 31	IP ≤ 31	IP > 31
NW08 & MTZ2	Size per phase	1b 80 x 5	1b 80 x 5	1b 80 x 5	1b 80 x 5	1b 80 x 5	1b 80 x 5	1b 80 x 5	1b 80 x 5	1b 80 x 5	1b 80 x 5	1b 80 x 5	■
	I (A)	800	800	800	800	800	800	800	800	800	800	800	
NW10 & MTZ2	Size per phase	1b 80 x 5	1b 80 x 5	1b 80 x 5	1b 80 x 5	1b 80 x 5	1b 80 x 5	1b 80 x 5	1b 80 x 5	1b 80 x 5	1b 80 x 5	1b 80 x 5	■
	I (A)	1000	1000	1000	1000	1000	1000	1000	1000	1000	1000	1000	
NW12 & MTZ2	Size per phase	2b 80 x 5	2b 80 x 5	2b 80 x 5	2b 80 x 5	2b 80 x 5	2b 80 x 5	2b 80 x 5	2b 80 x 5	2b 80 x 5	2b 80 x 5	2b 80 x 5	■
	I (A)	1250	1250	1250	1250	1250	1250	1250	1250	1250	1250	1250	
NW16 & MTZ2	Size per phase	2b 80 x 5	2b 80 x 5	2b 80 x 5	2b 80 x 5	2b 80 x 5	2b 80 x 5	2b 80 x 5	2b 80 x 5	2b 80 x 5	2b 80 x 5	2b 80 x 5	■
	I (A)	1600	1600	1600	1570	1600	1520	1570	1470	1520	1420	1470	

■ Connection impossible due to the operating-temperature limits of the devices installed in the switchboard.

(1) In the case of a door mounted at the rear of cubicle, add 10 °C.

Note: the values indicated above have been validated for PrismaSeT P Active switchboards.

Designing connections between a device and busbars

Fixed MasterPact 08-32

Electrical characteristics

MasterPact MTZ208 to 32 MasterPact MTZ2 08 to 32 Fixed

Vertical busbars on the left or right
Linergy LGYE, LGY, BS busbars
Connections drawings supplied by
Schneider Electric

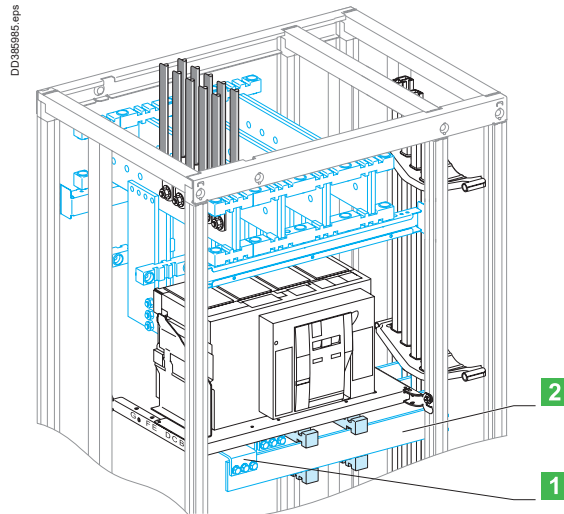

- 1** Connection.
- 2** Horizontal link.

Using the data below, it is possible to determine the size of the copper bars and the maximum permissible currents when making the connections to busbars for a vertical, fixed MasterPact MTZ2 08/32, front or rear connection, taking into account the ambient temperature around the switchboard and the IP value.

Connection

Flat bars, 10 mm thick

Device		Permissible current (A)												
		Ambient temperature around the switchboard												
		25 °C		30 °C		35 °C		40 °C		45 °C		50 °C		
		IP ≤ 31	IP > 31	IP ≤ 31	IP > 31	IP ≤ 31	IP > 31	IP ≤ 31	IP > 31	IP ≤ 31	IP > 31	IP ≤ 31	IP > 31	
NW08 & MTZ2	Size per phase	1b 80 x 10	1b 80 x 10	1b 80 x 10	1b 80 x 10	1b 80 x 10	1b 80 x 10	1b 80 x 10	1b 80 x 10	1b 80 x 10	1b 80 x 10	1b 80 x 10	1b 80 x 10	■
	I (A)	800	800	800	800	800	800	800	800	800	800	800	800	■
NW10 & MTZ2	Size per phase	1b 80 x 10	1b 80 x 10	1b 80 x 10	1b 80 x 10	1b 80 x 10	1b 80 x 10	1b 80 x 10	1b 80 x 10	1b 80 x 10	1b 80 x 10	1b 80 x 10	1b 80 x 10	■
	I (A)	1000	1000	1000	1000	1000	1000	1000	1000	1000	1000	1000	1000	■
NW12 & MTZ2	Size per phase	1b 80 x 10	1b 80 x 10	1b 80 x 10	1b 80 x 10	1b 80 x 10	1b 80 x 10	1b 80 x 10	1b 80 x 10	1b 80 x 10	1b 80 x 10	1b 80 x 10	1b 80 x 10	■
	I (A)	1250	1250	1250	1250	1250	1250	1250	1250	1250	1250	1250	1250	■
NW16 & MTZ2	Size per phase	1b 80 x 10	1b 80 x 10	1b 80 x 10	1b 80 x 10	1b 80 x 10	1b 80 x 10	1b 80 x 10	1b 80 x 10	1b 80 x 10	1b 80 x 10	1b 80 x 10	1b 80 x 10	■
	I (A)	1600	1600	1600	1570	1600	1520	1570	1470	1520	1420	1470	1470	■
NW20 & MTZ2	Size per phase	2b 80 x 10	2b 80 x 10	2b 80 x 10	2b 80 x 10	2b 80 x 10	2b 80 x 10	2b 80 x 10	2b 80 x 10	2b 80 x 10	2b 80 x 10	2b 80 x 10	2b 80 x 10	■
	I (A)	2000	2000	2000	2000	2000	2000	2000	1950	2000	1900	1950	1950	■
NW25 & MTZ2	Size per phase	2b 80 x 10	2b 80 x 10	2b 80 x 10	2b 80 x 10	2b 80 x 10	2b 80 x 10	2b 80 x 10	2b 80 x 10	2b 80 x 10	2b 80 x 10	2b 80 x 10	2b 80 x 10	■
	I (A)	2500	2500	2500	2500	2500	2460	2500	2380	2500	2300	2460	2460	■
NW32 & MTZ2	Size per phase	3b 80 x 10	3b 80 x 10	3b 80 x 10	3b 80 x 10	3b 80 x 10	3b 80 x 10	3b 80 x 10	3b 80 x 10	3b 80 x 10	3b 80 x 10	3b 80 x 10	3b 80 x 10	■
	I (A)	3200	3000	3170	2910	3080	2820	3000	2730	2910	2630	2820	2820	■

■ Connection impossible due to the operating-temperature limits of the devices installed in the switchboard.

Horizontal link

Flat bars, 10 mm thick

Device		Permissible current (A)												
		Ambient temperature around the switchboard												
		25 °C		30 °C		35 °C		40 °C		45 °C		50 °C		
		IP ≤ 31	IP > 31	IP ≤ 31	IP > 31	IP ≤ 31	IP > 31	IP ≤ 31	IP > 31	IP ≤ 31	IP > 31	IP ≤ 31	IP > 31	
NW08 & MTZ2	Size per phase	1b 60 x 10	1b 60 x 10	1b 60 x 10	1b 60 x 10	1b 60 x 10	1b 60 x 10	1b 60 x 10	1b 60 x 10	1b 60 x 10	1b 60 x 10	1b 60 x 10	1b 60 x 10	■
	I (A)	800	800	800	800	800	800	800	800	800	800	800	800	■
NW10 & MTZ2	Size per phase	1b 60 x 10	1b 60 x 10	1b 60 x 10	1b 60 x 10	1b 60 x 10	1b 60 x 10	1b 60 x 10	1b 60 x 10	1b 60 x 10	1b 60 x 10	1b 60 x 10	1b 60 x 10	■
	I (A)	1000	1000	1000	1000	1000	1000	1000	1000	1000	1000	1000	1000	■
NW12 & MTZ2	Size per phase	1b 60 x 10	1b 60 x 10	1b 60 x 10	1b 60 x 10	1b 60 x 10	1b 60 x 10	1b 60 x 10	1b 60 x 10	1b 60 x 10	1b 60 x 10	1b 60 x 10	1b 60 x 10	■
	I (A)	1250	1250	1250	1250	1250	1250	1250	1250	1250	1250	1250	1250	■
NW16 & MTZ2	Size per phase	1b 80 x 10	1b 80 x 10	1b 80 x 10	1b 80 x 10	1b 80 x 10	1b 80 x 10	1b 80 x 10	1b 80 x 10	1b 80 x 10	1b 80 x 10	1b 80 x 10	1b 80 x 10	■
	I (A)	1600	1600	1600	1570	1600	1520	1570	1470	1520	1420	1470	1470	■
NW20 & MTZ2	Size per phase	2b 60 x 10	2b 60 x 10	2b 60 x 10	2b 60 x 10	2b 60 x 10	2b 60 x 10	2b 60 x 10	2b 60 x 10	2b 60 x 10	2b 60 x 10	2b 60 x 10	2b 60 x 10	■
	I (A)	2000	2000	2000	2000	2000	2000	2000	1950	2000	1900	1950	1950	■
NW25 & MTZ2	Size per phase	2b 80 x 10	2b 80 x 10	2b 80 x 10	2b 80 x 10	2b 80 x 10	2b 80 x 10	2b 80 x 10	2b 80 x 10	2b 80 x 10	2b 80 x 10	2b 80 x 10	2b 80 x 10	■
	I (A)	2500	2500	2500	2500	2500	2460	2500	2380	2500	2300	2460	2460	■
NW32 & MTZ2	Size per phase	2b 100x10	2b 100x10	2b 100x10	2b 100x10	2b 100x10	2b 100x10	2b 100x10	2b 100x10	2b 100x10	2b 100x10	2b 100x10	2b 100x10	■
	I (A)	3200	3000	3170	2910	3080	2820	3000	2730	2910	2630	2820	2820	■

■ Connection impossible due to the operating-temperature limits of the devices installed in the switchboard.

Note: the values indicated above have been validated for PrismaSeT P Active switchboards.

Designing connections between a device and busbars

Drawout MasterPacT 08-16

Electrical characteristics

MasterPacT MTZ208 to 16 MasterPacT MTZ2 08 to 16 Drawout

Vertical busbars on the left or right
Linergy LGY, BS busbars
Connections drawings supplied by
Schneider Electric

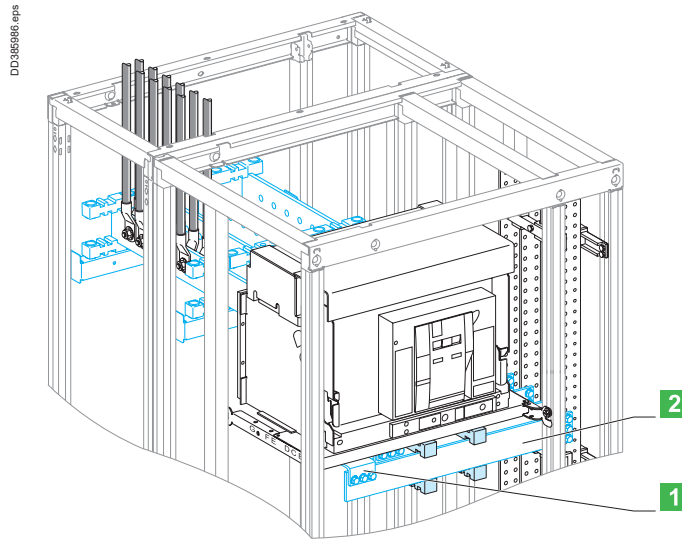

- 1** Connection.
- 2** Horizontal link.

Using the data below, it is possible to determine the size of the copper bars and the maximum permissible currents when making the connections to busbars for a vertical, drawout MasterPacT MTZ2 08/16, front or rear connection, taking into account the ambient temperature around the switchboard and the IP value.

Connection

Flat bars, 5 mm thick

Device		Permissible current (A)											
		Ambient temperature around the switchboard (1)											
		25 °C		30 °C		35 °C		40 °C		45 °C		50 °C	
		IP ≤ 31	IP > 31	IP ≤ 31	IP > 31	IP ≤ 31	IP > 31	IP ≤ 31	IP > 31	IP ≤ 31	IP > 31	IP ≤ 31	IP > 31
NW08 & MTZ2	Size per phase	1b 80 x 5	1b 80 x 5	1b 80 x 5	1b 80 x 5	1b 80 x 5	1b 80 x 5	1b 80 x 5	1b 80 x 5	1b 80 x 5	1b 80 x 5	1b 80 x 5	■
	I (A)	800	800	800	800	800	800	800	800	800	800	800	
NW10 & MTZ2	Size per phase	1b 80 x 5	1b 80 x 5	1b 80 x 5	1b 80 x 5	1b 80 x 5	1b 80 x 5	1b 80 x 5	1b 80 x 5	1b 80 x 5	1b 80 x 5	1b 80 x 5	■
	I (A)	1000	1000	1000	1000	1000	1000	1000	1000	1000	1000	1000	
NW12 & MTZ2	Size per phase	2b 80 x 5	2b 80 x 5	2b 80 x 5	2b 80 x 5	2b 80 x 5	2b 80 x 5	2b 80 x 5	2b 80 x 5	2b 80 x 5	2b 80 x 5	2b 80 x 5	■
	I (A)	1250	1250	1250	1250	1250	1230	1250	1200	1230	1160	1200	
NW16 & MTZ2	Size per phase	2b 80 x 5	2b 80 x 5	2b 80 x 5	2b 80 x 5	2b 80 x 5	2b 80 x 5	2b 80 x 5	2b 80 x 5	2b 80 x 5	2b 80 x 5	2b 80 x 5	■
	I (A)	1560	1480	1520	1430	1480	1380	1430	1330	1380	1280	1330	

■ Connection impossible due to the operating-temperature limits of the devices installed in the switchboard.

Horizontal link

Flat bars, 5 mm thick

Device		Permissible current (A)											
		Ambient temperature around the switchboard											
		25 °C		30 °C		35 °C		40 °C		45 °C		50 °C	
		IP ≤ 31	IP > 31	IP ≤ 31	IP > 31	IP ≤ 31	IP > 31	IP ≤ 31	IP > 31	IP ≤ 31	IP > 31	IP ≤ 31	IP > 31
NW08 & MTZ2	Size per phase	1b 80 x 5	1b 80 x 5	1b 80 x 5	1b 80 x 5	1b 80 x 5	1b 80 x 5	1b 80 x 5	1b 80 x 5	1b 80 x 5	1b 80 x 5	1b 80 x 5	■
	I (A)	800	800	800	800	800	800	800	800	800	800	800	
NW10 & MTZ2	Size per phase	1b 80 x 5	1b 80 x 5	1b 80 x 5	1b 80 x 5	1b 80 x 5	1b 80 x 5	1b 80 x 5	1b 80 x 5	1b 80 x 5	1b 80 x 5	1b 80 x 5	■
	I (A)	1000	1000	1000	1000	1000	1000	1000	1000	1000	1000	1000	
NW12 & MTZ2	Size per phase	2b 80 x 5	2b 80 x 5	2b 80 x 5	2b 80 x 5	2b 80 x 5	2b 80 x 5	2b 80 x 5	2b 80 x 5	2b 80 x 5	2b 80 x 5	2b 80 x 5	■
	I (A)	1250	1250	1250	1250	1250	1230	1250	1200	1230	1160	1200	
NW16 & MTZ2	Size per phase	2b 80 x 5	2b 80 x 5	2b 80 x 5	2b 80 x 5	2b 80 x 5	2b 80 x 5	2b 80 x 5	2b 80 x 5	2b 80 x 5	2b 80 x 5	2b 80 x 5	■
	I (A)	1560	1480	1520	1430	1480	1380	1430	1330	1380	1280	1330	

■ Connection impossible due to the operating-temperature limits of the devices installed in the switchboard.

(1) In the case of a door mounted at the rear of cubicle, add 10 °C.

Note: the values indicated above have been validated for PrismaSeT P Active switchboards.

Designing connections between a device and busbars

Drawout MasterPacT 08-32

Electrical characteristics

MasterPact MTZ208 to 32 MasterPacT MTZ2 08 to 32 Drawout

Vertical busbars on the left or right
Linergy LGYE, LGY, BS busbars
Connections drawings supplied by
Schneider Electric

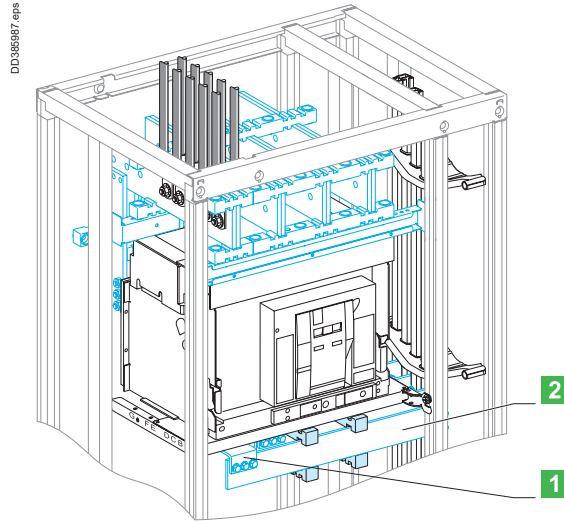

- 1** Connection.
- 2** Horizontal link.

Using the data below, it is possible to determine the size of the copper bars and the maximum permissible currents when making the connections to busbars for a vertical, drawout MasterPact MTZ2 08/32, front or rear connection, taking into account the ambient temperature around the switchboard and the IP value.

Connection

Flat bars, 10 mm thick

Device		Permissible current (A)												
		Ambient temperature around the switchboard												
		25 °C		30 °C		35 °C		40 °C		45 °C		50 °C		
		IP ≤ 31	IP > 31	IP ≤ 31	IP > 31	IP ≤ 31	IP > 31	IP ≤ 31	IP > 31	IP ≤ 31	IP > 31	IP ≤ 31	IP > 31	
NW08 & MTZ2	Size per phase	1b 80 x 10	1b 80 x 10	1b 80 x 10	1b 80 x 10	1b 80 x 10	1b 80 x 10	1b 80 x 10	1b 80 x 10	1b 80 x 10	1b 80 x 10	1b 80 x 10	1b 80 x 10	■
	I (A)	800	800	800	800	800	800	800	800	800	800	800	800	
NW10 & MTZ2	Size per phase	1b 80 x 10	1b 80 x 10	1b 80 x 10	1b 80 x 10	1b 80 x 10	1b 80 x 10	1b 80 x 10	1b 80 x 10	1b 80 x 10	1b 80 x 10	1b 80 x 10	1b 80 x 10	■
	I (A)	1000	1000	1000	1000	1000	1000	1000	1000	1000	1000	1000	1000	
NW12 & MTZ2	Size per phase	1b 80 x 10	1b 80 x 10	1b 80 x 10	1b 80 x 10	1b 80 x 10	1b 80 x 10	1b 80 x 10	1b 80 x 10	1b 80 x 10	1b 80 x 10	1b 80 x 10	1b 80 x 10	■
	I (A)	1250	1250	1250	1210	1250	1180	1210	1140	1180	1100	1140	1140	
NW16 & MTZ2	Size per phase	1b 80 x 10	1b 80 x 10	1b 80 x 10	1b 80 x 10	1b 80 x 10	1b 80 x 10	1b 80 x 10	1b 80 x 10	1b 80 x 10	1b 80 x 10	1b 80 x 10	1b 80 x 10	■
	I (A)	1560	1480	1520	1430	1480	1380	1430	1330	1380	1280	1330	1330	
NW20 & MTZ2	Size per phase	2b 80 x 10	2b 80 x 10	2b 80 x 10	2b 80 x 10	2b 80 x 10	2b 80 x 10	2b 80 x 10	2b 80 x 10	2b 80 x 10	2b 80 x 10	2b 80 x 10	2b 80 x 10	■
	I (A)	2000	2000	2000	1950	2000	1900	1950	1830	1900	1760	1830	1830	
NW25 & MTZ2	Size per phase	2b 80 x 10	2b 80 x 10	2b 80 x 10	2b 80 x 10	2b 80 x 10	2b 80 x 10	2b 80 x 10	2b 80 x 10	2b 80 x 10	2b 80 x 10	2b 80 x 10	2b 80 x 10	■
	I (A)	2470	2280	2410	2210	2350	2140	2280	2070	2210	2000	2140	2140	
NW32 & MTZ2	Size per phase	3b 80 x 10	3b 80 x 10	3b 80 x 10	3b 80 x 10	3b 80 x 10	3b 80 x 10	3b 80 x 10	3b 80 x 10	3b 80 x 10	3b 80 x 10	3b 80 x 10	3b 80 x 10	■
	I (A)	2960	2730	2890	2630	2820	2530	2730	2450	2630	2370	2530	2530	

■ Connection impossible due to the operating-temperature limits of the devices installed in the switchboard.

Horizontal link

Flat bars, 10 mm thick

Device		Permissible current (A)												
		Ambient temperature around the switchboard												
		25 °C		30 °C		35 °C		40 °C		45 °C		50 °C		
		IP ≤ 31	IP > 31	IP ≤ 31	IP > 31	IP ≤ 31	IP > 31	IP ≤ 31	IP > 31	IP ≤ 31	IP > 31	IP ≤ 31	IP > 31	
NW08 & MTZ2	Size per phase	1b 60 x 10	1b 60 x 10	1b 60 x 10	1b 60 x 10	1b 60 x 10	1b 60 x 10	1b 60 x 10	1b 60 x 10	1b 60 x 10	1b 60 x 10	1b 60 x 10	1b 60 x 10	■
	I (A)	800	800	800	800	800	800	800	800	800	800	800	800	
NW10 & MTZ2	Size per phase	1b 60 x 10	1b 60 x 10	1b 60 x 10	1b 60 x 10	1b 60 x 10	1b 60 x 10	1b 60 x 10	1b 60 x 10	1b 60 x 10	1b 60 x 10	1b 60 x 10	1b 60 x 10	■
	I (A)	1000	1000	1000	1000	1000	1000	1000	1000	1000	1000	1000	1000	
NW12 & MTZ2	Size per phase	1b 60 x 10	1b 60 x 10	1b 60 x 10	1b 60 x 10	1b 60 x 10	1b 60 x 10	1b 60 x 10	1b 60 x 10	1b 60 x 10	1b 60 x 10	1b 60 x 10	1b 60 x 10	■
	I (A)	1250	1250	1250	1210	1250	1180	1210	1140	1180	1100	1140	1140	
NW16 & MTZ2	Size per phase	1b 80 x 10	1b 80 x 10	1b 80 x 10	1b 80 x 10	1b 80 x 10	1b 80 x 10	1b 80 x 10	1b 80 x 10	1b 80 x 10	1b 80 x 10	1b 80 x 10	1b 80 x 10	■
	I (A)	1560	1480	1520	1430	1480	1380	1430	1330	1380	1280	1330	1330	
NW20 & MTZ2	Size per phase	2b 60 x 10	2b 60 x 10	2b 60 x 10	2b 60 x 10	2b 60 x 10	2b 60 x 10	2b 60 x 10	2b 60 x 10	2b 60 x 10	2b 60 x 10	2b 60 x 10	2b 60 x 10	■
	I (A)	2000	2000	2000	1950	2000	1900	1950	1830	1900	1760	1830	1830	
NW25 & MTZ2	Size per phase	2b 80 x 10	2b 80 x 10	2b 80 x 10	2b 80 x 10	2b 80 x 10	2b 80 x 10	2b 80 x 10	2b 80 x 10	2b 80 x 10	2b 80 x 10	2b 80 x 10	2b 80 x 10	■
	I (A)	2470	2280	2410	2210	2350	2140	2280	2070	2210	2000	2140	2140	
NW32 & MTZ2	Size per phase	2b 100x10	2b 100x10	2b 100x10	2b 100x10	2b 100x10	2b 100x10	2b 100x10	2b 100x10	2b 100x10	2b 100x10	2b 100x10	2b 100x10	■
	I (A)	2960	2730	2890	2630	2820	2530	2730	2450	2630	2370	2530	2530	

■ Connection impossible due to the operating-temperature limits of the devices installed in the switchboard.

Note: the values indicated above have been validated for PrismaSeT P Active switchboards.

Designing connections ≤ 630 A

Device connections

Electrical characteristics

Flexible copper bars with an insulating sheath

Switchboards that comply with standard IEC 61439-1/2

It is imperative to use the values indicated below that have been validated for the installation of devices in PrismaSeT switchboards.

The parameters determining the size of flexible bars are:

- the environment in which the devices are installed:
 - position in the enclosure
 - dimensions of other conductors in the circuit
 - ambient temperature around the switchboard
- the characteristics of the connected devices:
 - device heat losses
 - the type of installation (horizontal or vertical)
 - the type of device (fixed or withdrawable).

Only the equipment manufacturer with in-depth knowledge on:

- the characteristics of the installed devices
- the configuration of the installation in the enclosure can provide the correct sizes of flexible bars for a given permissible current.

Insulated, flexible bars make for easy, fast and flexible implementation up to 630 A, but higher ratings require sizes that cancel these advantages.

For high Isc values, it is advised to use rigid bars which require fewer supports.

Insulated flexible bars are better than cables, they offer:

- better insulation temperature withstand (125 °C for bars, 105 °C for cables) and a larger exchange surface for an equivalent size, i.e. a smaller size for a given current
- greater rigidity offering better electrodynamic characteristics for short-circuit currents
- no intermediate parts (lugs) for a direct connection between the device and the busbars therefore less temperature rise and less risk of error
- fast implementation of prefabricated connections already cut to length, formed and drilled.
- length limited to 500 mm.

Technical characteristics

- thickness of the insulation: variable depending on the bar size, 2 mm on average
- rated insulation level Ui = 1000 V
- impulse withstand voltage Uimp = 12 kV
- maximum withstand temperature of insulating material = 125 °C.

Connection

In all cubicles with IP ≤ 55 :

- the switchboard internal temperature is 60 °C
- the withstand temperature of the insulating material is 125 °C.

If the withstand temperature of the insulation is only 105 °C, use the next largest size of flexible bar given for standard insulated flexible bars (withstand temperature = 125 °C)

The bar sizes indicated below take into account the derating curves of devices.

Connection of devices to busbars

Device	INS-INV125	INS-INV160	INS-INV250	INS-INV320 INS-INV400	INS-INV500 INS-INV630	GS250 ISFT250	GS400 ISFT400	GS630 ISFT630
S (mm)	20 x 2	20 x 2	20 x 3	32 x 5	32 x 6	24 x 5	32 x 5	32 x 8

Connection of distribution blocks to busbars

Distribution block	Linerigy FM 200 A	Linerigy FC 3P	Linerigy FC 4P
S (mm)	20 x 3	32 x 8	32 x 8

Connection of disconnectors, Linerigy TB, connections, busbars to busbars

I max. (60 °C)	200 A	250 A	400 A	400 A	480 A	520 A	580 A	660 A
S (mm)	20 x 2	20 x 3	24 x 5	24 x 5	24 x 6	32 x 5	32 x 6	32 x 8

Note: The values indicated above have been validated for PrismaSeT P Active switchboards.

Designing connections ≤ 630 A

ComPacT circuit breakers NSX100 to NSX630

Insulated flexible copper bars ⁽¹⁾

Electrical characteristics

ComPacT NSX100 to NSX630

Insulated flexible copper bars (withstand temperature = 125 °C)

We recommend insulated flexible copper bars for ComPacT NSX connections from 100 to 630 A

Devices		Permissible current (A)					
		Ambient temperature around the switchboard					
		25 °C	30 °C	35 °C	40 °C	45 °C	50 °C
IP ≤ 31							
NSX100 TMD-TMG	Size per phase	20 x 2	20 x 2	20 x 2	20 x 2	20 x 2	20 x 2
	I _{nc} (A)	100	100	100	97.5	95	92.5
NSX125 TMD-TMG	Size per phase	20 x 2	20 x 2	20 x 2	20 x 2	20 x 2	20 x 2
	I _{nc} (A)	125	125	125	122	119	115
NSX160 (2) TMD-TMG	Size per phase	20 x 3	20 x 3	20 x 3	20 x 3	20 x 3	20 x 3
	I _{nc} (A)	160	160	160	156	152	148
NSX250 (2) TMD-TMG	Size per phase	20 x 3	20 x 3	20 x 3	20 x 3	20 x 3	20 x 3
	I _{nc} (A)	250	244	238	231	225	219
NSX100 STR	Size per phase	20 x 2	20 x 2	20 x 2	20 x 2	20 x 2	20 x 2
	I _{nc} (A)	100	100	100	100	100	100
NSX160 STR	Size per phase	20 x 3	20 x 3	20 x 3	20 x 3	20 x 3	20 x 3
	I _{nc} (A)	160	160	160	160	160	160
NSX250 (3) STR	Size per phase	20 x 3	20 x 3	20 x 3	20 x 3	20 x 3	20 x 3
	I _{nc} (A)	250	245	237	230	225	220
NSX400B/F/N/H/S/L fixed	Size per phase	32 x 5	32 x 5	32 x 5	32 x 5	32 x 5	32 x 5
	I _{nc} (A)	400	400	400	390	380	370
NSX400B/F/N/H/S/L with Vigi NSX400B/F/N/H/S/L ELCB	Size per phase	32 x 5	32 x 5	32 x 5	32 x 5	32 x 5	32 x 5
	I _{nc} (A)	400	390	380	370	360	350
NSX400B/F/N/H/S/L withdrawable	Size per phase	32 x 5	32 x 5	32 x 5	32 x 5	32 x 5	32 x 5
	I _{nc} (A)	400	390	380	370	360	350
NSX630B/F/N/H/S/L fixed	Size per phase	32 x 6	32 x 6	32 x 6	32 x 6	32 x 6	32 x 6
	I _{nc} (A)	630	615	600	585	570	550
NSX630B/F/N/H/S/L with Vigi or withdrawable NSX630B/F/N/H/S/L ELCB	Size per phase	32 x 8	32 x 8	32 x 8	32 x 8	32 x 8	32 x 8
	I _{nc} (A)	570	550	535	520	505	490
IP > 31							
NSX100 TMD-TMG	Size per phase	20 x 2	20 x 2	20 x 2	20 x 2	20 x 2	20 x 2
	I _{nc} (A)	100	100	100	97.5	95	92.5
NSX125 TMD-TMG	Size per phase	20 x 2	20 x 2	20 x 2	20 x 2	20 x 2	20 x 2
	I _{nc} (A)	125	125	125	122	119	115
NSX160 (2) TMD-TMG	Size per phase	20 x 3	20 x 3	20 x 3	20 x 3	20 x 3	20 x 3
	I _{nc} (A)	160	160	160	156	152	148
NSX250 (2) TMD-TMG	Size per phase	20 x 3	20 x 3	20 x 3	20 x 3	20 x 3	20 x 3
	I _{nc} (A)	238	231	225	219	213	207
NSX100 STR	Size per phase	20 x 2	20 x 2	20 x 2	20 x 2	20 x 2	20 x 2
	I _{nc} (A)	100	100	100	100	100	100
NSX160 STR	Size per phase	20 x 3	20 x 3	20 x 3	20 x 3	20 x 3	20 x 3
	I _{nc} (A)	160	160	160	160	160	160
NSX250 (3) STR	Size per phase	20 x 3	20 x 3	20 x 3	20 x 3	20 x 3	20 x 3
	I _{nc} (A)	237	230	225	220	215	210
NSX400B/F/N/H/S/L fixed	Size per phase	32 x 5	32 x 5	32 x 5	32 x 5	32 x 5	32 x 5
	I _{nc} (A)	400	400	400	390	380	370
Vigi NSX400B/F/N/H/S/L NSX400B/F/N/H/S/L Vigi (ELCB)	Size per phase	32 x 5	32 x 5	32 x 5	32 x 5	32 x 5	32 x 5
	I _{nc} (A)	400	390	380	370	360	350
NSX400B/F/N/H/S/L withdrawable	Size per phase	32 x 5	32 x 5	32 x 5	32 x 5	32 x 5	32 x 5
	I _{nc} (A)	400	390	380	370	360	350
NSX630B/F/N/H/S/L fixed	Size per phase	32 x 6	32 x 6	32 x 6	32 x 6	32 x 6	32 x 6
	I _{nc} (A)	600	585	570	550	535	520
NSX630B/F/N/H/S/L withdrawable Vigi NSX630B/F/N/H/S/L NSX630B/F/N/H/S/L Vigi (ELCB)	Size per phase	32 x 8	32 x 8	32 x 8	32 x 8	32 x 8	32 x 8
	I _{nc} (A)	535	520	505	490	475	420

Note: the values indicated above have been validated for PrismaSeT P Active switchboards.

(1) We recommend insulated flexible copper bars instead of copper cables for all NSX100 to NSX630 connection.

(2) For a withdrawable NSX160/250 equipped with a Vigi or NSX Vigi 160/250 (ELCB) or an insulation-monitoring module, multiply the I_n values by 0.9 .

(3) For a withdrawable NSX250 equipped with Vigi or NSX Vigi 250 (ELCB) or an insulation-monitoring module, multiply the I_n values by 0.86.

To connect a ComPacT NSX250 and NSX Vigi 250 ELCB to a Linergy BW busbars, use a 24 x 5 flexible bar cat. no. **LVS04746**.

Designing connections ≤ 630 A

ComPacT circuit breakers NSX100 to NSX250

Copper cable

Electrical characteristics

Cables: practical guidelines

This section doesn't concern customer's loads connection (see IEC 61439-1, IEC 60364).

Schneider Electric provides cabling recommendations according to the rating of the circuit breaker.

The size of cables must be selected according to:

- the level of current
- the ambient temperature around the conductors
- the degree of protection for the switchboard.

The tables below take into account the installation conditions for each type of device (permissible temperature at connection terminals, etc.).

They follow the temperature derating values for installed devices in all cubicles with cover panels rated IP ≤ 55 .

- switchboard internal temperature 60 °C
- connections using copper cables.

The withstand temperature of insulating material of cable = 105°C.

The withstand voltage of insulating material of cable ≥ 1000 V.

ComPacT NSX100 to NSX250

Copper cable, withstand temperature = 105 °C

Devices		Permissible current (A)					
		Ambient temperature around the switchboard					
		25 °C	30 °C	35 °C	40 °C	45 °C	50 °C
IP ≤ 31							
NSX100 TMD-TMG	Size per phase	50 mm ²	50 mm ²	50 mm ²	50 mm ²	50 mm ²	50 mm ²
	I _{nc} (A)	100	100	100	97.5	95	92.5
NSX125 TMD-TMG	Size per phase	70 mm ²	70 mm ²	70 mm ²	70 mm ²	70 mm ²	70 mm ²
	I _{nc} (A)	125	125	125	122	119	115
NSX160 (1) TMD-TMG	Size per phase	95 mm ²	95 mm ²	95 mm ²	95 mm ²	95 mm ²	95 mm ²
	I _{nc} (A)	160	160	160	156	152	148
NSX250 (1) TMD-TMG	Size per phase	120 mm ²	120 mm ²	120 mm ²	120 mm ²	120 mm ²	120 mm ²
	I _{nc} (A)	250	244	238	231	225	219
NSX100 STR	Size per phase	50 mm ²	50 mm ²	50 mm ²	50 mm ²	50 mm ²	50 mm ²
	I _{nc} (A)	100	100	100	100	100	100
NSX160 STR	Size per phase	95 mm ²	95 mm ²	95 mm ²	95 mm ²	95 mm ²	95 mm ²
	I _{nc} (A)	160	160	160	160	160	160
NSX250 (2) STR	Size per phase	120 mm ²	120 mm ²	120 mm ²	120 mm ²	120 mm ²	120 mm ²
	I _{nc} (A)	250	245	237	230	225	220
IP > 31							
NSX100 TMD-TMG	Size per phase	50 mm ²	50 mm ²	50 mm ²	50 mm ²	50 mm ²	50 mm ²
	I _{nc} (A)	100	100	100	97.5	95	92.5
NSX125 TMD-TMG	Size per phase	70 mm ²	70 mm ²	70 mm ²	70 mm ²	70 mm ²	70 mm ²
	I _{nc} (A)	125	125	125	122	119	115
NSX160 (1) TMD-TMG	Size per phase	95 mm ²	95 mm ²	95 mm ²	95 mm ²	95 mm ²	95 mm ²
	I _{nc} (A)	160	160	160	156	152	148
NSX250 (1) TMD-TMG	Size per phase	120 mm ²	120 mm ²	120 mm ²	120 mm ²	120 mm ²	120 mm ²
	I _{nc} (A)	237	230	225	220	215	210
NSX100 STR	Size per phase	50 mm ²	50 mm ²	50 mm ²	50 mm ²	50 mm ²	50 mm ²
	I _{nc} (A)	100	100	100	100	100	100
NSX160 STR	Size per phase	95 mm ²	95 mm ²	95 mm ²	95 mm ²	95 mm ²	95 mm ²
	I _{nc} (A)	160	160	160	160	160	160
NSX250 (2) STR	Size per phase	120 mm ²	120 mm ²	120 mm ²	120 mm ²	120 mm ²	120 mm ²
	I _{nc} (A)	237	230	225	220	215	210

(1) For a withdrawable NSX160/250 equipped with a Vigi or NSX Vigi 160/250 (ELCB) or an insulation-monitoring module, multiply the I_n values by 0.9.

(2) For a withdrawable NSX250 equipped with a Vigi or NSX Vigi 250 (ELCB) or an insulation-monitoring module, multiply the I_n values by 0.86.

Note: the values indicated above have been validated for PrismaSeT P Active switchboards.

Note: Schneider Electric recommends connecting ComPacT NSX400/630 circuit breakers with insulated flexible bars or rigid bars > page I-43.

Designing connections ≤ 630 A

ComPacT circuit breakers NSXm up to 160

Copper cable

Electrical characteristics

ComPacT NSXm up to 160

Copper cable, withstand temperature = 105°C

Devices		Permissible current (A)					
		Ambient temperature around the switchboard					
		25 °C	30 °C	35 °C	40 °C	45 °C	50 °C
IP ≤ 31							
NSXm100	Size per phase (mm ²)	50	50	50	50	50	50
	I _{nc} (A)	100	100	96	94	90	87
NSXm125	Size per phase (mm ²)	70	70	70	70	70	70
	I _{nc} (A)	125	125	120	117	113	109
NSXm160	Size per phase (mm ²)	95	95	95	95	95	95
	I _{nc} (A)	160	155	149	144	139	133
NSXm 100 ELCB	Size per phase (mm ²)	50	50	50	50	50	50
	I _{nc} (A)	100	100	100	100	96	93
NSXm 160 ELCB	Size per phase (mm ²)	95	95	95	95	95	95
	I _{nc} (A)	160	155	150	145	140	135
IP > 31							
NSXm100	Size per phase (mm ²)	50	50	50	50	50	50
	I _{nc} (A)	100	100	96	94	90	87
NSXm125	Size per phase (mm ²)	70	70	70	70	70	70
	I _{nc} (A)	125	120	117	113	109	104
NSXm160	Size per phase (mm ²)	95	95	95	95	95	95
	I _{nc} (A)	160	155	149	144	139	133
NSXm 100 ELCB	Size per phase (mm ²)	50	50	50	50	50	50
	I _{nc} (A)	100	100	100	100	96	93
NSXm 160 ELCB	Size per phase (mm ²)	95	95	95	95	95	95
	I _{nc} (A)	160	155	150	145	140	135

Note: the values indicated above have been validated for PrismaSeT P Active switchboards.

Designing cable connections

Tubular lugs

Electrical characteristics

Tubular lugs for incoming connection blocks

Maximum size of lugs for connection to the different incoming connection blocks.

	Standard Cu lugs	Narrow Cu lugs	Narrow bimetal lugs
Incoming connection block for ComPacT NSX-INS-INV250 supplied via the top or the bottom, cat. no. LVS04066 et LVS04067	150 mm ²	240 mm ²	185 mm ²
In-duct incoming connection block for ComPacT NSX630 supplied via the top or the bottom cat. no. LVS04076	240 mm ²	300 mm ²	300 mm ²

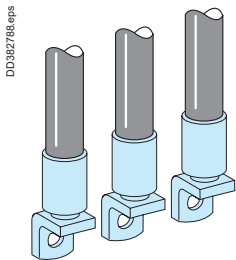

DD382788.eps

Narrow bimetal lugs

Cat. no. selection

Cat. no.	Cable size (mm ²)	Quantity
Lugs for aluminium cable (1)		
29504	150	3
29505	150	4
29506	185	3
29507	185	4
32504	240	3
32505	240	4
32506	300	3
32507	300	4

Customer connection of devices ≥ 630 A

Maximum size and number of cables for connection to terminal extension bars (according to busbar drawing supplied) for customer connection of ComPacT NSX and MasterPact MTZ1 /MTZ2 and NT devices.

	Cable size (mm ²)	Quantity
Size and number of cables		
Copper lugs	300	12
Bimetal lugs	240	12

(1) Supplied with 2 or 3 interphase barriers.

Designing customer connections

Prefabricated connections for ComPacT NS630b to NS1600

Electrical characteristics

ComPacT NS630b to NS1600

- Vertical mounting
- Front or rear connection
- Incoming via top or bottom

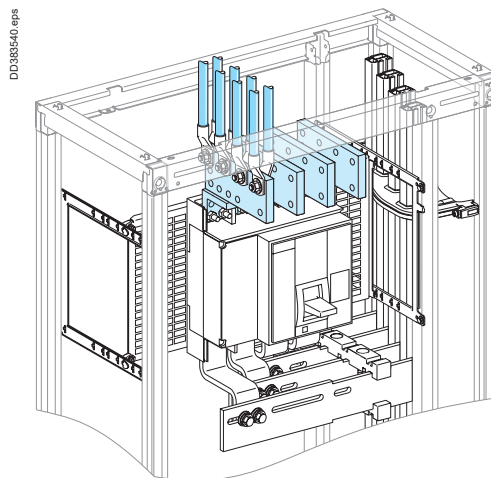

Using the data below, it is possible to determine the permissible current for a prefabricated connection between a vertical ComPacT NS630b/NS1600, fixed or withdrawable, and Linergy busbars depending on the ambient temperature around the switchboard and the IP value.

Fixed

Prefabricated connections

Device and cat. no.	Permissible current (A)												
	Ambient temperature around the switchboard												
	25 °C		30 °C		35 °C		40 °C		45 °C		50 °C		
	IP ≤ 31	IP > 31	IP ≤ 31	IP > 31	IP ≤ 31	IP > 31	IP ≤ 31	IP > 31	IP ≤ 31	IP > 31	IP ≤ 31	IP > 31	
NS630b 3P cat. no. 33642	630	630	630	630	630	630	630	630	630	630	630	630	■
4P cat. no. 33643													
NS800 3P cat. no. 33642	800	800	800	800	800	800	800	800	800	800	800	800	■
4P cat. no. 33643													
NS1000 3P cat. no. 33642	1000	1000	1000	1000	1000	1000	1000	1000	1000	1000	1000	1000	■
4P cat. no. 33643													
NS1250 3P réf. 33642 + 33644	1250	1250	1250	1250	1250	1250	1250	1200	1250	1150	1200	1200	■
4P réf. 33643 + 33645													
NS1600 3P réf. 33642 + 33644	1600	1550	1600	1500	1550	1450	1500	1400	1450	1350	1400	1400	■
4P réf. 33643 + 33645													

■ Connection impossible due to the operating-temperature limits of the devices installed in the switchboard.

Withdrawable

Prefabricated connections

Device and cat. no.	Permissible current (A)												
	Ambient temperature around the switchboard												
	25 °C		30 °C		35 °C		40 °C		45 °C		50 °C		
	IP ≤ 31	IP > 31	IP ≤ 31	IP > 31	IP ≤ 31	IP > 31	IP ≤ 31	IP > 31	IP ≤ 31	IP > 31	IP ≤ 31	IP > 31	
NS630b 3P cat. no. 33642	630	630	630	630	630	630	630	630	630	630	630	630	■
4P cat. no. 33643													
NS800 3P cat. no. 33642	800	800	800	800	800	800	800	800	800	800	800	800	■
4P cat. no. 33643													
NS1000 3P cat. no. 33642	1000	1000	1000	1000	1000	1000	1000	1000	1000	1000	1000	1000	■
4P cat. no. 33643													
NS1250 3P réf. 33642 + 33644	1250	1250	1250	1250	1250	1250	1250	1200	1250	1150	1200	1200	■
4P réf. 33643 + 33645													
NS1600 3P réf. 33642 + 33644	1560	1480	1520	1430	1480	1380	1430	1330	1380	1280	1330	1330	■
4P réf. 33643 + 33645													

■ Connection impossible due to the operating-temperature limits of the devices installed in the switchboard.

Note: the values indicated above have been validated for PrismaSeT P Active switchboards.

Designing customer connections

Prefabricated connections for MasterPacT 06-16

Electrical characteristics

MasterPact MTZ106 to 16

- Vertical mounting
- Front or rear connection
- Incoming via top or bottom

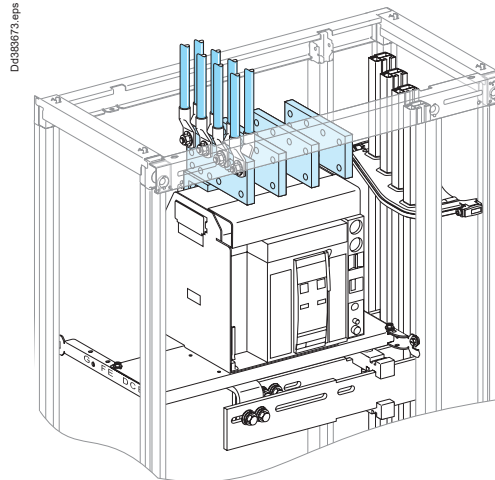

Using the data below, it is possible to determine the permissible current for a prefabricated connection between a vertical MasterPact MTZ1 06/16, fixed or drawout, and Linergy busbars depending on the ambient temperature around the switchboard and the IP value.

Fixed

Prefabricated connections

Device and cat. no.		Permissible current (A)												
		Ambient temperature around the switchboard												
		25 °C		30 °C		35 °C		40 °C		45 °C		50 °C		
		IP ≤ 31	IP > 31	IP ≤ 31	IP > 31	IP ≤ 31	IP > 31	IP ≤ 31	IP > 31	IP ≤ 31	IP > 31	IP ≤ 31	IP > 31	
NT06	3P cat. no. 33642	630	630	630	630	630	630	630	630	630	630	630	630	■
	4P cat. no. 33643													
NT08	3P cat. no. 33642	800	800	800	800	800	800	800	800	800	800	800	800	■
	4P cat. no. 33643													
NT10	3P cat. no. 33642	1000	1000	1000	1000	1000	1000	1000	1000	1000	1000	1000	1000	■
	4P cat. no. 33643													
NT12	3P réf. 33642 + 33644	1250	1250	1250	1250	1250	1250	1250	1200	1250	1150	1200	■	
	4P réf. 33643 + 33645													
NT16	3P réf. 33642 + 33644	1600	1570	1600	1520	1570	1470	1520	1420	1470	1370	1420	■	
	4P réf. 33643 + 33645													

■ Connection impossible due to the operating-temperature limits of the devices installed in the switchboard.

Withdrawable

Prefabricated connections

Device and cat. no.		Permissible current (A)												
		Ambient temperature around the switchboard												
		25 °C		30 °C		35 °C		40 °C		45 °C		50 °C		
		IP ≤ 31	IP > 31	IP ≤ 31	IP > 31	IP ≤ 31	IP > 31	IP ≤ 31	IP > 31	IP ≤ 31	IP > 31	IP ≤ 31	IP > 31	
NT06	3P cat. no. 33642	630	630	630	630	630	630	630	630	630	630	630	630	■
	4P cat. no. 33643													
NT08	3P cat. no. 33642	800	800	800	800	800	800	800	800	800	800	800	800	■
	4P cat. no. 33643													
NT10	3P cat. no. 33642	1000	1000	1000	1000	1000	1000	1000	1000	1000	1000	1000	1000	■
	4P cat. no. 33643													
NT12	3P réf. 33642 + 33644	1250	1250	1250	1250	1250	1250	1250	1200	1250	1150	1200	■	
	4P réf. 33643 + 33645													
NT16	3P réf. 33642 + 33644	1560	1480	1520	1430	1480	1380	1430	1330	1380	1280	1330	■	
	4P réf. 33643 + 33645													

■ Connection impossible due to the operating-temperature limits of the devices installed in the switchboard.

Note: the values indicated above have been validated for PrismaSeT P Active switchboards.

Designing customer connections

Connection transfer assembly for fixed ComPacT NS630b to NS1000

Electrical characteristics

ComPacT NS630b to NS1000, fixed

- Horizontal mounting
- Front or rear connection
- Installation on the left or right

D1638541 eps

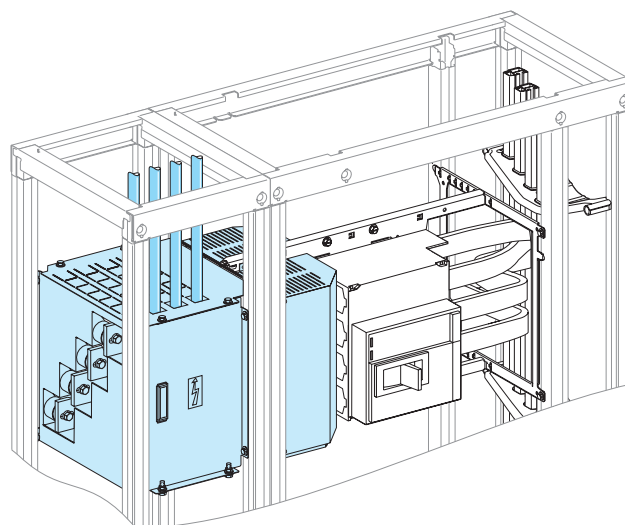

Using the data below, it is possible to determine the permissible current for a prefabricated connection between a horizontal, fixed ComPacT NS630b/NS1000 and Linergy busbars depending on the ambient temperature around the switchboard and the IP value.

Connection transfer assemblies

Device and cat. no.		Permissible current (A)											
		Ambient temperature around the switchboard											
		25 °C		30 °C		35 °C		40 °C		45 °C		50 °C	
		IP ≤ 31	IP > 31	IP ≤ 31	IP > 31	IP ≤ 31	IP > 31	IP ≤ 31	IP > 31	IP ≤ 31	IP > 31	IP ≤ 31	IP > 31
NS630b	3P cat. no. LVS04483	630	630	630	630	630	630	630	630	630	630	630	■
	4P cat. no. LVS04484												
NS800	3P cat. no. LVS04483	800	800	800	800	800	800	800	800	800	800	800	■
	4P cat. no. LVS04484												
NS1000	3P cat. no. LVS04483	1000	1000	1000	1000	1000	1000	1000	1000	1000	1000	1000	■
	4P cat. no. LVS04484												

■ Connection impossible due to the operating-temperature limits of the devices installed in the switchboard.

Note: the values indicated above have been validated for PrismaSeT P Active switchboards.

Designing customer connections

Fixed MasterPacT 08-16

Electrical characteristics

MasterPact MTZ208 to 16 Fixed

- Vertical mounting
- Front or rear connection
- Incoming via top or bottom
- Busbar drawings supplied by Schneider Electric

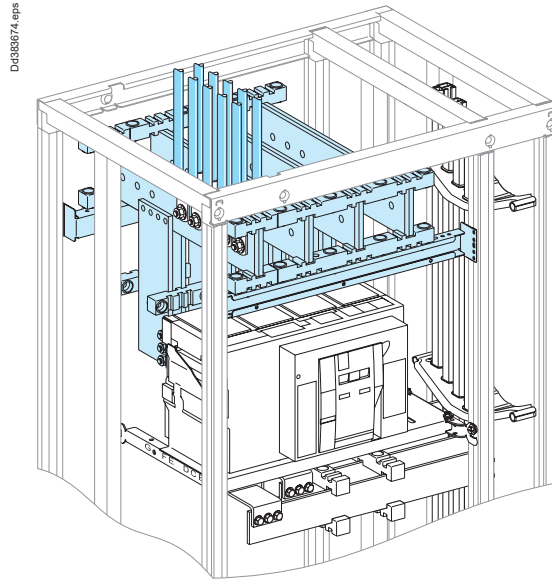

Using the data below, it is possible to determine the size of the copper bars and the maximum permissible currents when making a front or rear customer connection for a vertical, fixed MasterPact MTZ1 06/16, taking into account the ambient temperature around the switchboard and the IP value. Connection to be made according to the busbar drawings supplied. For connection cable cross-sections and quantities > [page I-46](#).

Customer connection

Flat bars, 5 mm thick

Device		Permissible current (A)												
		Ambient temperature around the switchboard												
		25 °C		30 °C		35 °C		40 °C		45 °C		50 °C		
		IP ≤ 31	IP > 31	IP ≤ 31	IP > 31	IP ≤ 31	IP > 31	IP ≤ 31	IP > 31	IP ≤ 31	IP > 31	IP ≤ 31	IP > 31	
NW08	Size per phase	2b 60 x 5	2b 60 x 5	2b 60 x 5	2b 60 x 5	2b 60 x 5	2b 60 x 5	2b 60 x 5	2b 60 x 5	2b 60 x 5	2b 60 x 5	2b 60 x 5	2b 60 x 5	■
	I (A)	800	800	800	800	800	800	800	800	800	800	800	800	
NW10	Size per phase	2b 60 x 5	2b 60 x 5	2b 60 x 5	2b 60 x 5	2b 60 x 5	2b 60 x 5	2b 60 x 5	2b 60 x 5	2b 60 x 5	2b 60 x 5	2b 60 x 5	2b 60 x 5	■
	I (A)	1000	1000	1000	1000	1000	1000	1000	1000	1000	1000	1000	1000	
NW12	Size per phase	2b 80 x 5	2b 80 x 5	2b 80 x 5	2b 80 x 5	2b 80 x 5	2b 80 x 5	2b 80 x 5	2b 80 x 5	2b 80 x 5	2b 80 x 5	2b 80 x 5	2b 80 x 5	■
	I (A)	1250	1250	1250	1250	1250	1250	1250	1250	1250	1250	1250	1250	
NW16	Size per phase	2b 80 x 5	2b 80 x 5	2b 80 x 5	2b 80 x 5	2b 80 x 5	2b 80 x 5	2b 80 x 5	2b 80 x 5	2b 80 x 5	2b 80 x 5	2b 80 x 5	2b 80 x 5	■
	I (A)	1600	1600	1600	1570	1600	1520	1570	1470	1520	1420	1470		

■ Connection impossible due to the operating-temperature limits of the devices installed in the switchboard.

Note: the values indicated above have been validated for PrismaSeT P Active switchboards.

Designing customer connections

Fixed MasterPacT 08-40

Electrical characteristics

MasterPact MTZ208 to 40 Fixed

- Vertical mounting
- Front or rear connection
- Incoming via top or bottom
- Busbar drawings supplied by Schneider Electric

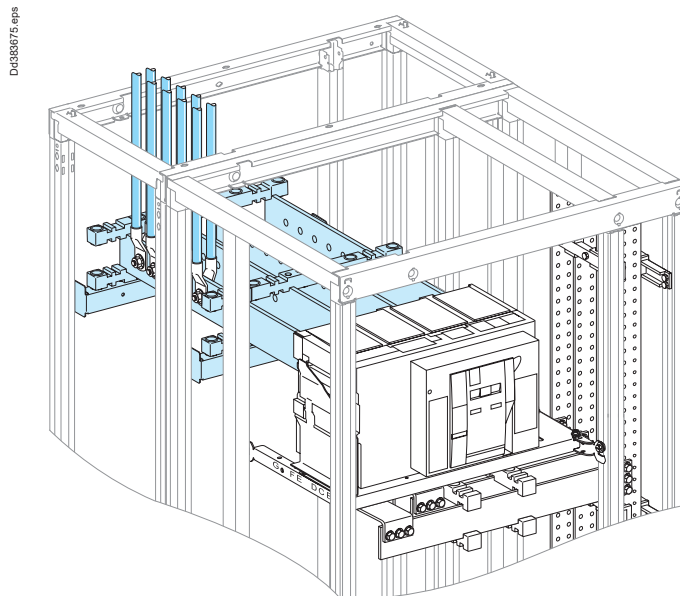

Customer connection

Flat bars, 10 mm thick

Device		Permissible current (A)											
		Ambient temperature around the switchboard											
		25 °C		30 °C		35 °C		40 °C		45 °C		50 °C	
		IP ≤ 31	IP > 31	IP ≤ 31	IP > 31	IP ≤ 31	IP > 31	IP ≤ 31	IP > 31	IP ≤ 31	IP > 31	IP ≤ 31	IP > 31
NW08	Size per phase	1b 60 x 10	1b 60 x 10	1b 60 x 10	1b 60 x 10	1b 60 x 10	1b 60 x 10	1b 60 x 10	1b 60 x 10	1b 60 x 10	1b 60 x 10	1b 60 x 10	■
	I (A)	800	800	800	800	800	800	800	800	800	800	800	
NW10	Size per phase	1b 60 x 10	1b 60 x 10	1b 60 x 10	1b 60 x 10	1b 60 x 10	1b 60 x 10	1b 60 x 10	1b 60 x 10	1b 60 x 10	1b 60 x 10	1b 60 x 10	■
	I (A)	1000	1000	1000	1000	1000	1000	1000	1000	1000	1000	1000	
NW12	Size per phase	1b 60 x 10	1b 60 x 10	1b 60 x 10	1b 60 x 10	1b 60 x 10	1b 60 x 10	1b 60 x 10	1b 60 x 10	1b 60 x 10	1b 60 x 10	1b 60 x 10	■
	I (A)	1250	1250	1250	1250	1250	1250	1250	1250	1250	1250	1250	
NW16	Size per phase	1b 80 x 10	1b 80 x 10	1b 80 x 10	1b 80 x 10	1b 80 x 10	1b 80 x 10	1b 80 x 10	1b 80 x 10	1b 80 x 10	1b 80 x 10	1b 80 x 10	■
	I (A)	1600	1600	1600	1570	1600	1520	1570	1470	1520	1420	1470	
NW20	Size per phase	2b 80 x 10	2b 80 x 10	2b 80 x 10	2b 80 x 10	2b 80 x 10	2b 80 x 10	2b 80 x 10	2b 80 x 10	2b 80 x 10	2b 80 x 10	2b 80 x 10	■
	I (A)	2000	2000	2000	2000	2000	2000	2000	1950	2000	1900	1950	
NW25	Size per phase	2b 100 x 10	2b 100 x 10	2b 100 x 10	2b 100 x 10	2b 100 x 10	2b 100 x 10	2b 100 x 10	2b 100 x 10	2b 100 x 10	2b 100 x 10	2b 100 x 10	■
	I (A)	2500	2500	2500	2500	2500	2460	2500	2380	2500	2300	2460	
NW32	Size per phase	2b 120 x 10	2b 120 x 10	2b 120 x 10	2b 120 x 10	2b 120 x 10	2b 120 x 10	2b 120 x 10	2b 120 x 10	2b 120 x 10	2b 120 x 10	2b 120 x 10	■
	I (A)	3200	3000	3170	2910	3080	2820	3000	2730	2910	2630	2820	
NW40	Size per phase	(2)	(2)	(2)	(2)	(2)	(2)	(2)	(2)	(2)	(2)	(2)	■
	I (A) (1)												

■ Connection impossible due to the operating-temperature limits of the devices installed in the switchboard.

Canalis connection

For Canalis connections, apply the appropriate derating coefficient K.

Device	NW08	NW10	NW12	NW16	NW20	NW25	NW32	NW40
Derating coefficient K	1	1	1	0,98	0,98	0,97	0,97	(2)

(1) For NW40 IP >31, performances realized with forced ventilation.

(2) Contact Schneider Electric for 4000 A dedicated cubicle.

Note: the values indicated above have been validated for PrismaSeT P Active switchboards.

Designing customer connections

Drawout MasterPacT 08-16

Electrical characteristics

MasterPact MTZ208 to 16 Drawout

- Vertical mounting
- Front or rear connection
- Incoming via top or bottom
- Busbar drawings supplied by Schneider Electric

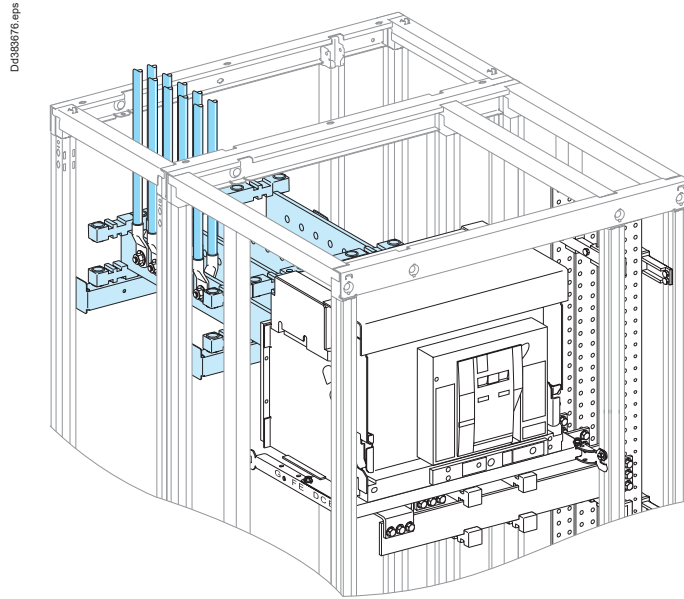

Using the data below, it is possible to determine the size of the copper bars and the maximum permissible currents when making a front or rear customer connections to busbars for a vertical, drawout MasterPact MTZ1 08/16, taking into account the ambient temperature around the switchboard and the IP value. Connection to be made according to the busbar drawings supplied. For connection cable cross-sections and quantities > [page I-46](#).

Customer connection

Flat bars, 5 mm thick

Device		Permissible current (A)											
		Ambient temperature around the switchboard											
		25 °C		30 °C		35 °C		40 °C		45 °C		50 °C	
		IP ≤ 31	IP > 31	IP ≤ 31	IP > 31	IP ≤ 31	IP > 31	IP ≤ 31	IP > 31	IP ≤ 31	IP > 31	IP ≤ 31	IP > 31
NW08	Size per phase	2b 60 x 5	2b 60 x 5	2b 60 x 5	2b 60 x 5	2b 60 x 5	2b 60 x 5	2b 60 x 5	2b 60 x 5	2b 60 x 5	2b 60 x 5	2b 60 x 5	2b 60 x 5
	I (A)	800	800	800	800	800	800	800	800	800	800	800	800
NW10	Size per phase	2b 60 x 5	2b 60 x 5	2b 60 x 5	2b 60 x 5	2b 60 x 5	2b 60 x 5	2b 60 x 5	2b 60 x 5	2b 60 x 5	2b 60 x 5	2b 60 x 5	2b 60 x 5
	I (A)	1000	1000	1000	1000	1000	1000	1000	1000	1000	1000	1000	1000
NW12	Size per phase	2b 80 x 5	2b 80 x 5	2b 80 x 5	2b 80 x 5	2b 80 x 5	2b 80 x 5	2b 80 x 5	2b 80 x 5	2b 80 x 5	2b 80 x 5	2b 80 x 5	2b 80 x 5
	I (A)	1250	1250	1250	1250	1250	1230	1250	1200	1230	1160	1200	1200
NW16	Size per phase	2b 80 x 5	2b 80 x 5	2b 80 x 5	2b 80 x 5	2b 80 x 5	2b 80 x 5	2b 80 x 5	2b 80 x 5	2b 80 x 5	2b 80 x 5	2b 80 x 5	2b 80 x 5
	I (A)	1560	1480	1520	1430	1480	1380	1430	1330	1380	1280	1330	1330

■ Connection impossible due to the operating-temperature limits of the devices installed in the switchboard.

Note: the values indicated above have been validated for PrismaSeT P Active switchboards.

Designing customer connections

MasterPacT 08-40 withdrawable

Electrical characteristics

MasterPact MTZ208 to 40 Drawout

- Vertical mounting
- Front or rear connection
- Incoming via top or bottom
- Busbar drawings supplied by Schneider Electric

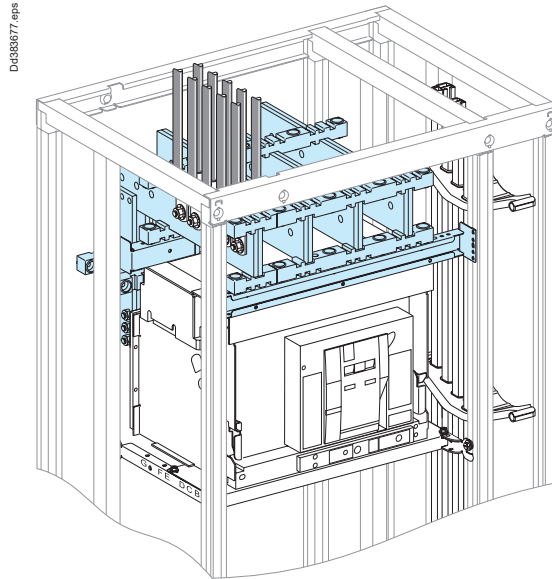

Customer connection

Flat bars, 10 mm thick

Device		Permissible current (A)												
		Ambient temperature around the switchboard												
		25 °C		30 °C		35 °C		40 °C		45 °C		50 °C		
		IP ≤ 31	IP > 31	IP ≤ 31	IP > 31	IP ≤ 31	IP > 31	IP ≤ 31	IP > 31	IP ≤ 31	IP > 31	IP ≤ 31	IP > 31	
NW08	Size per phase	1b 60 x 10	1b 60 x 10	1b 60 x 10	1b 60 x 10	1b 60 x 10	1b 60 x 10	1b 60 x 10	1b 60 x 10	1b 60 x 10	1b 60 x 10	1b 60 x 10	1b 60 x 10	■
	I (A)	800	800	800	800	800	800	800	800	800	800	800	800	
NW10	Size per phase	1b 60 x 10	1b 60 x 10	1b 60 x 10	1b 60 x 10	1b 60 x 10	1b 60 x 10	1b 60 x 10	1b 60 x 10	1b 60 x 10	1b 60 x 10	1b 60 x 10	1b 60 x 10	■
	I (A)	1000	1000	1000	1000	1000	1000	1000	1000	1000	1000	1000	1000	
NW12	Size per phase	1b 60 x 10	1b 60 x 10	1b 60 x 10	1b 60 x 10	1b 60 x 10	1b 60 x 10	1b 60 x 10	1b 60 x 10	1b 60 x 10	1b 60 x 10	1b 60 x 10	1b 60 x 10	■
	I (A)	1250	1250	1250	1210	1250	1180	1210	1140	1180	1100	1140		
NW16	Size per phase	1b 80 x 10	1b 80 x 10	1b 80 x 10	1b 80 x 10	1b 80 x 10	1b 80 x 10	1b 80 x 10	1b 80 x 10	1b 80 x 10	1b 80 x 10	1b 80 x 10	1b 80 x 10	■
	I (A)	1560	1480	1520	1430	1480	1380	1430	1330	1380	1280	1330		
NW20	Size per phase	2b 80 x 10	2b 80 x 10	2b 80 x 10	2b 80 x 10	2b 80 x 10	2b 80 x 10	2b 80 x 10	2b 80 x 10	2b 80 x 10	2b 80 x 10	2b 80 x 10	2b 80 x 10	■
	I (A)	2000	2000	2000	1950	2000	1900	1950	1830	1900	1760	1830		
NW25	Size per phase	2b100 x 10	2b100 x 10	2b100 x 10	2b100 x 10	2b100 x 10	2b100 x 10	2b100 x 10	2b100 x 10	2b100 x 10	2b100 x 10	2b100 x 10	2b100 x 10	■
	I (A)	2470	2280	2410	2210	2350	2140	2280	2070	2210	2000	2140		
NW32	Size per phase	2b120 x 10	2b120 x 10	2b120 x 10	2b120 x 10	2b120 x 10	2b120 x 10	2b120 x 10	2b120 x 10	2b120 x 10	2b120 x 10	2b120 x 10	2b120 x 10	■
	I (A)	2960	2730	2890	2630	2820	2530	2730	2450	2630	2370	2530		
NW40	Size per phase	(2)	(2)	(2)	(2)	(2)	(2)	(2)	(2)	(2)	(2)	(2)	(2)	■
	I (A) (1)													

■ Connection impossible due to the operating-temperature limits of the devices installed in the switchboard.

Canalis connection

For Canalis connections, apply the appropriate derating coefficient K.

Device	NW08	NW10	NW12	NW16	NW20	NW25	NW32
Derating coefficient K	1	1	1	0,98	0,98	0,97	0,97

(1) For NW40 IP >31, performances realized with forced ventilation.

(2) Contact Schneider Electric for 4000 A dedicated cubicle.

Note: the values indicated above have been validated for PrismaSeT P Active switchboards.

Designing customer connections

Fixed MasterPacT 06-16

Electrical characteristics

MasterPact MTZ106 to 16 Fixed

Rear connection
Incoming via top or bottom
Busbar drawings supplied by
Schneider Electric

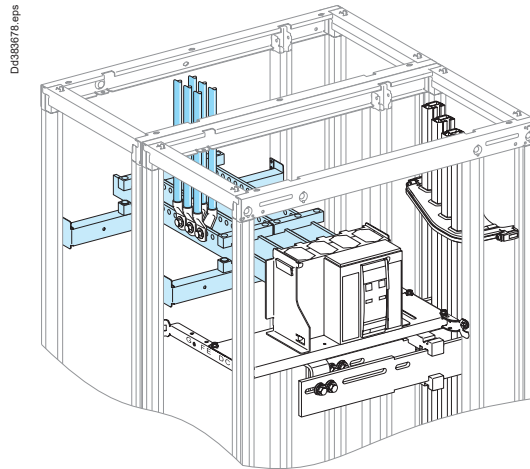

Using the data below, it is possible to determine the size of the copper bars and the maximum permissible currents when making a front or rear customer connections to busbars for a vertical, fixed MasterPact MTZ1 06/16, taking into account the ambient temperature around the switchboard and the IP value.
Connection to be made according to the busbar drawings supplied.
For connection cable cross-sections and quantities > [page I-46](#).

Customer connection

Flat bars, 5 mm thick

Device		Permissible current (A)												
		Ambient temperature around the switchboard												
		25 °C		30 °C		35 °C		40 °C		45 °C		50 °C		
		IP ≤ 31	IP > 31	IP ≤ 31	IP > 31	IP ≤ 31	IP > 31	IP ≤ 31	IP > 31	IP ≤ 31	IP > 31	IP ≤ 31	IP > 31	
NT06	Size per phase	1b 60 x 5	1b 60 x 5	1b 60 x 5	1b 60 x 5	1b 60 x 5	1b 60 x 5	1b 60 x 5	1b 60 x 5	1b 60 x 5	1b 60 x 5	1b 60 x 5	1b 60 x 5	■
	I (A)	630	630	630	630	630	630	630	630	630	630	630	630	
NT08	Size per phase	1b 80 x 5	1b 80 x 5	1b 80 x 5	1b 80 x 5	1b 80 x 5	1b 80 x 5	1b 80 x 5	1b 80 x 5	1b 80 x 5	1b 80 x 5	1b 80 x 5	1b 80 x 5	■
	I (A)	800	800	800	800	800	800	800	800	800	800	800	800	
NT10	Size per phase	2b 50 x 5	2b 50 x 5	2b 50 x 5	2b 50 x 5	2b 50 x 5	2b 50 x 5	2b 50 x 5	2b 50 x 5	2b 50 x 5	2b 50 x 5	2b 50 x 5	2b 50 x 5	■
	I (A)	1000	1000	1000	1000	1000	1000	1000	1000	1000	1000	1000	1000	
NT12	Size per phase	2b 80 x 5	2b 80 x 5	2b 80 x 5	2b 80 x 5	2b 80 x 5	2b 80 x 5	2b 80 x 5	2b 80 x 5	2b 80 x 5	2b 80 x 5	2b 80 x 5	2b 80 x 5	■
	I (A)	1250	1250	1250	1250	1250	1250	1250	1250	1250	1250	1200	1250	
NT16	Size per phase	2b 100 x 5	2b 100 x 5	2b 100 x 5	2b 100 x 5	2b 100 x 5	2b 100 x 5	2b 100 x 5	2b 100 x 5	2b 100 x 5	2b 100 x 5	2b 100 x 5	2b 100 x 5	■
	I (A)	1600	1570	1600	1520	1570	1470	1520	1420	1470	1370	1420		

■ Connection impossible due to the operating-temperature limits of the devices installed in the switchboard.

Customer connection

Flat bars, 10 mm thick

Device		Permissible current (A)												
		Ambient temperature around the switchboard												
		25 °C		30 °C		35 °C		40 °C		45 °C		50 °C		
		IP ≤ 31	IP > 31	IP ≤ 31	IP > 31	IP ≤ 31	IP > 31	IP ≤ 31	IP > 31	IP ≤ 31	IP > 31	IP ≤ 31	IP > 31	
NT06	Size per phase	1b 50 x 10	1b 50 x 10	1b 50 x 10	1b 50 x 10	1b 50 x 10	1b 50 x 10	1b 50 x 10	1b 50 x 10	1b 50 x 10	1b 50 x 10	1b 50 x 10	1b 50 x 10	■
	I (A)	630	630	630	630	630	630	630	630	630	630	630	630	
NT08	Size per phase	1b 50 x 10	1b 50 x 10	1b 50 x 10	1b 50 x 10	1b 50 x 10	1b 50 x 10	1b 50 x 10	1b 50 x 10	1b 50 x 10	1b 50 x 10	1b 50 x 10	1b 50 x 10	■
	I (A)	800	800	800	800	800	800	800	800	800	800	800	800	
NT10	Size per phase	1b 50 x 10	1b 50 x 10	1b 50 x 10	1b 50 x 10	1b 50 x 10	1b 50 x 10	1b 50 x 10	1b 50 x 10	1b 50 x 10	1b 50 x 10	1b 50 x 10	1b 50 x 10	■
	I (A)	1000	1000	1000	1000	1000	1000	1000	1000	1000	1000	1000	1000	
NT12	Size per phase	1b 80 x 10	1b 80 x 10	1b 80 x 10	1b 80 x 10	1b 80 x 10	1b 80 x 10	1b 80 x 10	1b 80 x 10	1b 80 x 10	1b 80 x 10	1b 80 x 10	1b 80 x 10	■
	I (A)	1250	1250	1250	1250	1250	1250	1250	1250	1250	1180	1230		
NT16	Size per phase	1b100 x 10	1b100 x 10	1b100 x 10	1b100 x 10	1b100 x 10	1b100 x 10	1b100 x 10	1b100 x 10	1b100 x 10	1b100 x 10	1b100 x 10	1b100 x 10	■
	I (A)	1600	1570	1600	1520	1570	1470	1520	1420	1470	1370	1420		

■ Connection impossible due to the operating-temperature limits of the devices installed in the switchboard.

Canalis connection

For Canalis connections, apply the appropriate derating coefficient K.

Device	NT06b	NT08	NT10	NT12	NT16
Derating coefficient K	1	1	1	1	0,98

Note: the values indicated above have been validated for PrismaSeT P Active switchboards.

Designing customer connections

Drawout MasterPacT 06-16

Electrical characteristics

MasterPact MTZ106 to 16

Rear connection

Incoming via top or bottom

Busbar drawings supplied by Schneider Electric

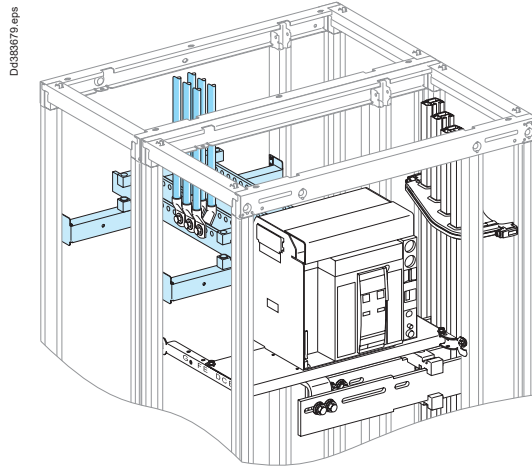

Using the data below, it is possible to determine the size of the copper bars and the maximum permissible currents when making a customer connections to busbars for a vertical, drawout MasterPact MTZ1 06/16, taking into account the ambient temperature around the switchboard and the IP value. Connection to be made according to the busbar drawings supplied. For connection cable cross-sections and quantities > [page I-46](#).

Customer connection

Flat bars, 5 mm thick

Device		Permissible current (A)											
		Ambient temperature around the switchboard											
		25 °C		30 °C		35 °C		40 °C		45 °C		50 °C	
		IP ≤ 31	IP > 31	IP ≤ 31	IP > 31	IP ≤ 31	IP > 31	IP ≤ 31	IP > 31	IP ≤ 31	IP > 31	IP ≤ 31	IP > 31
NT06	Size per phase	1b 60 x 5	1b 60 x 5	1b 60 x 5	1b 60 x 5	1b 60 x 5	1b 60 x 5	1b 60 x 5	1b 60 x 5	1b 60 x 5	1b 60 x 5	1b 60 x 5	1b 60 x 5
	I (A)	630	630	630	630	630	630	630	630	630	630	630	■
NT08	Size per phase	1b 80 x 5	1b 80 x 5	1b 80 x 5	1b 80 x 5	1b 80 x 5	1b 80 x 5	1b 80 x 5	1b 80 x 5	1b 80 x 5	1b 80 x 5	1b 80 x 5	1b 80 x 5
	I (A)	800	800	800	800	800	800	800	800	800	800	800	■
NT10	Size per phase	2b 50 x 5	2b 50 x 5	2b 50 x 5	2b 50 x 5	2b 50 x 5	2b 50 x 5	2b 50 x 5	2b 50 x 5	2b 50 x 5	2b 50 x 5	2b 50 x 5	2b 50 x 5
	I (A)	1000	1000	1000	1000	1000	1000	1000	1000	1000	960	1000	■
NT12	Size per phase	2b 80 x 5	2b 80 x 5	2b 80 x 5	2b 80 x 5	2b 80 x 5	2b 80 x 5	2b 80 x 5	2b 80 x 5	2b 80 x 5	2b 80 x 5	2b 80 x 5	2b 80 x 5
	I (A)	1250	1250	1250	1250	1250	1230	1250	1180	1230	1130	1180	■
NT16	Size per phase	2b 100 x 5	2b 100 x 5	2b 100 x 5	2b 100 x 5	2b 100 x 5	2b 100 x 5	2b 100 x 5	2b 100 x 5	2b 100 x 5	2b 100 x 5	2b 100 x 5	2b 100 x 5
	I (A)	1560	1430	1520	1430	1480	1380	1430	1330	1380	1280	1330	■

■ Connection impossible due to the operating-temperature limits of the devices installed in the switchboard.

Customer connection

Flat bars, 10 mm thick

Device		Permissible current (A)											
		Ambient temperature around the switchboard											
		25 °C		30 °C		35 °C		40 °C		45 °C		50 °C	
		IP ≤ 31	IP > 31	IP ≤ 31	IP > 31	IP ≤ 31	IP > 31	IP ≤ 31	IP > 31	IP ≤ 31	IP > 31	IP ≤ 31	IP > 31
NT06	Size per phase	1b 50 x 10	1b 50 x 10	1b 50 x 10	1b 50 x 10	1b 50 x 10	1b 50 x 10	1b 50 x 10	1b 50 x 10	1b 50 x 10	1b 50 x 10	1b 50 x 10	1b 50 x 10
	I (A)	630	630	630	630	630	630	630	630	630	630	630	■
NT08	Size per phase	1b 50 x 10	1b 50 x 10	1b 50 x 10	1b 50 x 10	1b 50 x 10	1b 50 x 10	1b 50 x 10	1b 50 x 10	1b 50 x 10	1b 50 x 10	1b 50 x 10	1b 50 x 10
	I (A)	800	800	800	800	800	800	800	800	800	800	800	■
NT10	Size per phase	1b 50 x 10	1b 50 x 10	1b 50 x 10	1b 50 x 10	1b 50 x 10	1b 50 x 10	1b 50 x 10	1b 50 x 10	1b 50 x 10	1b 50 x 10	1b 50 x 10	1b 50 x 10
	I (A)	1000	1000	1000	1000	1000	1000	1000	1000	1000	960	1000	■
NT12	Size per phase	1b 80 x 10	1b 80 x 10	1b 80 x 10	1b 80 x 10	1b 80 x 10	1b 80 x 10	1b 80 x 10	1b 80 x 10	1b 80 x 10	1b 80 x 10	1b 80 x 10	1b 80 x 10
	I (A)	1250	1250	1250	1250	1250	1210	1250	1160	1210	1110	1160	■
NT16	Size per phase	1b100 x 10	1b100 x 10	1b100 x 10	1b100 x 10	1b100 x 10	1b100 x 10	1b100 x 10	1b100 x 10	1b100 x 10	1b100 x 10	1b100 x 10	1b100 x 10
	I (A)	1560	1430	1520	1430	1480	1380	1430	1330	1380	1280	1330	■

■ Connection impossible due to the operating-temperature limits of the devices installed in the switchboard.

Canalis connection

For Canalis connections, apply the appropriate derating coefficient K.

Device	NT06	NT08	NT10	NT12	NT16
Derating coefficient K	1	1	1	1	0,98

Note: the values indicated above have been validated for PrismaSeT P Active switchboards.

Designing customer connections

Fixed ComPacT NS1600b to NS3200

Electrical characteristics

ComPacT NS1600b/3200 fixed

- Front or rear connection
- Incoming via top or bottom
- Busbar drawings supplied by Schneider Electric

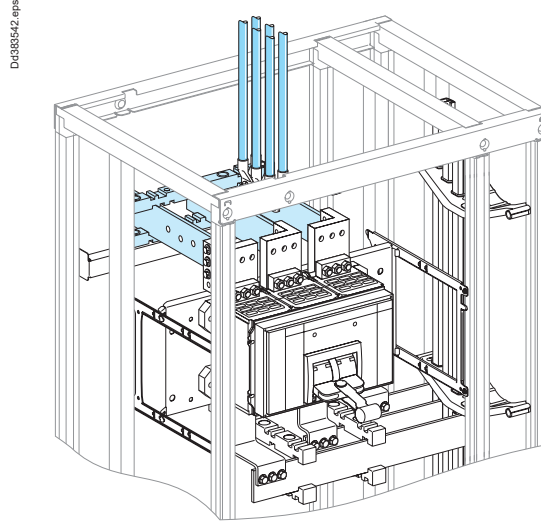

Using the data below, it is possible to determine the size of the copper bars and the maximum permissible currents when making a front or rear customer connections to busbars for a vertical, fixed ComPacT NS1600b/NS3200, taking into account the ambient temperature around the switchboard and the IP value. Connection to be made according to the busbar drawings supplied. For connection cable cross-sections and quantities > [page I-46](#).

Customer connection

Flat bars, 10 mm thick

Device		Permissible current (A)											
		Ambient temperature around the switchboard											
		25 °C		30 °C		35 °C		40 °C		45 °C		50 °C	
		IP ≤ 31	IP > 31	IP ≤ 31	IP > 31	IP ≤ 31	IP > 31	IP ≤ 31	IP > 31	IP ≤ 31	IP > 31	IP ≤ 31	IP > 31
NS1600b	Size per phase	1b 80 x 10	1b 80 x 10	1b 80 x 10	1b 80 x 10	1b 80 x 10	1b 80 x 10	1b 80 x 10	1b 80 x 10	1b 80 x 10	1b 80 x 10	1b 80 x 10	■
	I (A)	1560	1480	1520	1430	1480	1380	1430	1330	1380	1280	1330	
NS2000	Size per phase	2b 80 x 10	2b 80 x 10	2b 80 x 10	2b 80 x 10	2b 80 x 10	2b 80 x 10	2b 80 x 10	2b 80 x 10	2b 80 x 10	2b 80 x 10	2b 80 x 10	■
	I (A)	2000	2000	2000	1950	2000	1900	1950	1830	1900	1760	1830	
NS2500	Size per phase	2b100 x 10	2b100 x 10	2b100 x 10	2b100 x 10	2b100 x 10	2b100 x 10	2b100 x 10	2b100 x 10	2b100 x 10	2b100 x 10	2b100 x 10	■
	I (A)	2470	2280	2410	2210	2350	2140	2280	2070	2210	2000	2140	
NS3200	Size per phase	2b120 x 10	2b120 x 10	2b120 x 10	2b120 x 10	2b120 x 10	2b120 x 10	2b120 x 10	2b120 x 10	2b120 x 10	2b120 x 10	2b120 x 10	■
	I (A)	2860	2630	2790	2530	2720	2430	2630	2350	2530	2270	2430	

■ Connection impossible due to the operating-temperature limits of the devices installed in the switchboard.

Note: the values indicated above have been validated for PrismaSeT P Active switchboards.

Designing customer connections

Fixed ComPacT NS630b to NS1600

Electrical characteristics

ComPacT NS630b to NS1600

Fixed

Rear connection

Incoming via top or bottom

Busbar drawings supplied by

Schneider Electric

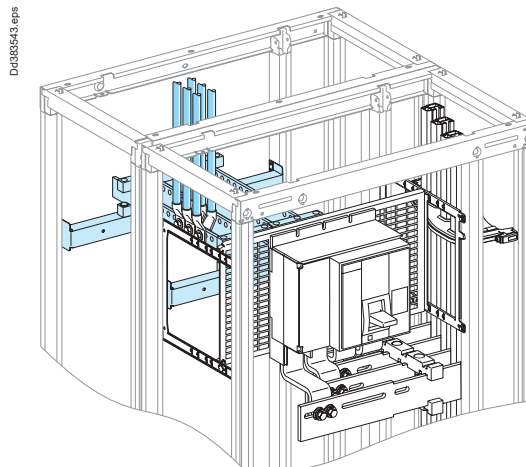

Using the data below, it is possible to determine the size of the copper bars and the maximum permissible currents when making a rear customer connection for a vertical, fixed ComPacT NS630b/NS1600, taking into account the ambient temperature around the switchboard and the IP value.

Connection to be made according to the busbar drawings supplied.

For connection cable cross-sections and quantities > page I-46.

Customer connection

Flat bars, 5 mm thick

Device		Permissible current (A)												
		Ambient temperature around the switchboard												
		25 °C		30 °C		35 °C		40 °C		45 °C		50 °C		
		IP ≤ 31	IP > 31	IP ≤ 31	IP > 31	IP ≤ 31	IP > 31	IP ≤ 31	IP > 31	IP ≤ 31	IP > 31	IP ≤ 31	IP > 31	
NS630b	Size per phase	1b 60 x 5	1b 60 x 5	1b 60 x 5	1b 60 x 5	1b 60 x 5	1b 60 x 5	1b 60 x 5	1b 60 x 5	1b 60 x 5	1b 60 x 5	1b 60 x 5	1b 60 x 5	■
	I (A)	630	630	630	630	630	630	630	630	630	630	630	630	
NS800	Size per phase	1b 80 x 5	1b 80 x 5	1b 80 x 5	1b 80 x 5	1b 80 x 5	1b 80 x 5	1b 80 x 5	1b 80 x 5	1b 80 x 5	1b 80 x 5	1b 80 x 5	1b 80 x 5	■
	I (A)	800	800	800	800	800	800	800	800	800	800	800	800	
NS1000	Size per phase	2b 50 x 5	2b 50 x 5	2b 50 x 5	2b 50 x 5	2b 50 x 5	2b 50 x 5	2b 50 x 5	2b 50 x 5	2b 50 x 5	2b 50 x 5	2b 50 x 5	2b 50 x 5	■
	I (A)	1000	1000	1000	1000	1000	1000	1000	1000	1000	1000	970	1000	
NS1250	Size per phase	2b 80 x 5	2b 80 x 5	2b 80 x 5	2b 80 x 5	2b 80 x 5	2b 80 x 5	2b 80 x 5	2b 80 x 5	2b 80 x 5	2b 80 x 5	2b 80 x 5	2b 80 x 5	■
	I (A)	1250	1250	1250	1250	1250	1250	1250	1200	1250	1150	1200	1200	
NS1600	Size per phase	2b 100 x 5	2b 100 x 5	2b 100 x 5	2b 100 x 5	2b 100 x 5	2b 100 x 5	2b 100 x 5	2b 100 x 5	2b 100 x 5	2b 100 x 5	2b 100 x 5	2b 100 x 5	■
	I (A)	1600	1550	1600	1500	1550	1450	1500	1400	1450	1350	1400		

■ Connection impossible due to the operating-temperature limits of the devices installed in the switchboard.

Customer connection

Flat bars, 10 mm thick

Device		Permissible current (A)												
		Ambient temperature around the switchboard												
		25 °C		30 °C		35 °C		40 °C		45 °C		50 °C		
		IP ≤ 31	IP > 31	IP ≤ 31	IP > 31	IP ≤ 31	IP > 31	IP ≤ 31	IP > 31	IP ≤ 31	IP > 31	IP ≤ 31	IP > 31	
NS630b	Size per phase	1b 50 x 10	1b 50 x 10	1b 50 x 10	1b 50 x 10	1b 50 x 10	1b 50 x 10	1b 50 x 10	1b 50 x 10	1b 50 x 10	1b 50 x 10	1b 50 x 10	1b 50 x 10	■
	I (A)	630	630	630	630	630	630	630	630	630	630	630	630	
NS800	Size per phase	1b 50 x 10	1b 50 x 10	1b 50 x 10	1b 50 x 10	1b 50 x 10	1b 50 x 10	1b 50 x 10	1b 50 x 10	1b 50 x 10	1b 50 x 10	1b 50 x 10	1b 50 x 10	■
	I (A)	800	800	800	800	800	800	800	800	800	800	800	800	
NS1000	Size per phase	1b 50 x 10	1b 50 x 10	1b 50 x 10	1b 50 x 10	1b 50 x 10	1b 50 x 10	1b 50 x 10	1b 50 x 10	1b 50 x 10	1b 50 x 10	1b 50 x 10	1b 50 x 10	■
	I (A)	1000	1000	1000	1000	1000	1000	1000	1000	1000	970	1000	1000	
NS1250	Size per phase	1b 80 x 10	1b 80 x 10	1b 80 x 10	1b 80 x 10	1b 80 x 10	1b 80 x 10	1b 80 x 10	1b 80 x 10	1b 80 x 10	1b 80 x 10	1b 80 x 10	1b 80 x 10	■
	I (A)	1250	1250	1250	1250	1250	1250	1250	1180	1230	1130	1180	1180	
NS1600	Size per phase	1b 100 x 10	1b 100 x 10	1b 100 x 10	1b 100 x 10	1b 100 x 10	1b 100 x 10	1b 100 x 10	1b 100 x 10	1b 100 x 10	1b 100 x 10	1b 100 x 10	1b 100 x 10	■
	I (A)	1600	1550	1600	1500	1550	1450	1500	1400	1450	1350	1400		

■ Connection impossible due to the operating-temperature limits of the devices installed in the switchboard.

Canalis connection

For Canalis connections, apply the appropriate derating coefficient K.

Device	NS630b	NS800	NS1000	NS1250	NS1600
Derating coefficient K	1	1	1	1	0,98

Note: the values indicated above have been validated for PrismaSeT P Active switchboards.

Designing customer connections

Withdrawable ComPacT NS630b to NS1600

Electrical characteristics

ComPacT NS630b to NS1600 Withdrawable

Rear connection
Incoming via top or bottom
Busbar drawings supplied by
Schneider Electric

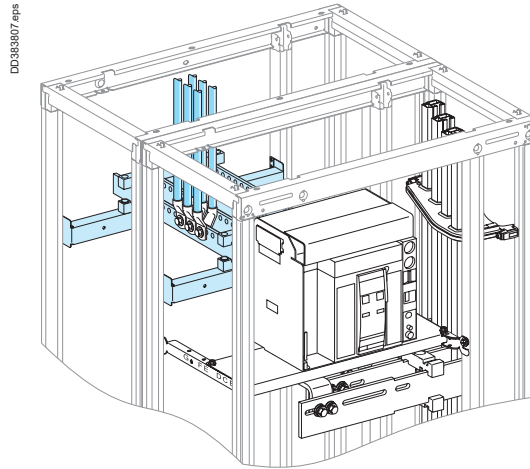

Using the data below, it is possible to determine the size of the copper bars and the maximum permissible currents when making a rear customer connection for a vertical, withdrawable ComPacT NS630b/NS1600, taking into account the ambient temperature around the switchboard and the IP value.
Connection to be made according to the busbar drawings supplied.
For connection cable cross-sections and quantities > [page I-46](#).

Customer connection

Flat bars, 5 mm thick

Device	Permissible current (A)	Ambient temperature around the switchboard											
		25 °C		30 °C		35 °C		40 °C		45 °C		50 °C	
		IP ≤ 31	IP > 31	IP ≤ 31	IP > 31	IP ≤ 31	IP > 31	IP ≤ 31	IP > 31	IP ≤ 31	IP > 31	IP ≤ 31	IP > 31
NS630b	Size per phase	1b 60 x 5	1b 60 x 5	1b 60 x 5	1b 60 x 5	1b 60 x 5	1b 60 x 5	1b 60 x 5	1b 60 x 5	1b 60 x 5	1b 60 x 5	1b 60 x 5	■
	I (A)	630	630	630	630	630	630	630	630	630	630	630	
NS800	Size per phase	1b 80 x 5	1b 80 x 5	1b 80 x 5	1b 80 x 5	1b 80 x 5	1b 80 x 5	1b 80 x 5	1b 80 x 5	1b 80 x 5	1b 80 x 5	1b 80 x 5	■
	I (A)	800	800	800	800	800	800	800	800	800	800	800	
NS1000	Size per phase	2b 50 x 5	2b 50 x 5	2b 50 x 5	2b 50 x 5	2b 50 x 5	2b 50 x 5	2b 50 x 5	2b 50 x 5	2b 50 x 5	2b 50 x 5	2b 50 x 5	■
	I (A)	1000	1000	1000	1000	1000	1000	1000	1000	1000	960	1000	
NS1250	Size per phase	2b 80 x 5	2b 80 x 5	2b 80 x 5	2b 80 x 5	2b 80 x 5	2b 80 x 5	2b 80 x 5	2b 80 x 5	2b 80 x 5	2b 80 x 5	2b 80 x 5	■
	I (A)	1250	1250	1250	1250	1250	1230	1250	1180	1230	1130	1180	
NS1600	Size per phase	2b 100 x 5	2b 100 x 5	2b 100 x 5	2b 100 x 5	2b 100 x 5	2b 100 x 5	2b 100 x 5	2b 100 x 5	2b 100 x 5	2b 100 x 5	2b 100 x 5	■
	I (A)	1560	1430	1520	1430	1480	1380	1430	1330	1380	1280	1330	

■ Connection impossible due to the operating-temperature limits of the devices installed in the switchboard.

Customer connection

Flat bars, 10 mm thick

Device	Permissible current (A)	Ambient temperature around the switchboard											
		25 °C		30 °C		35 °C		40 °C		45 °C		50 °C	
		IP ≤ 31	IP > 31	IP ≤ 31	IP > 31	IP ≤ 31	IP > 31	IP ≤ 31	IP > 31	IP ≤ 31	IP > 31	IP ≤ 31	IP > 31
NS630b	Size per phase	1b 50 x 10	1b 50 x 10	1b 50 x 10	1b 50 x 10	1b 50 x 10	1b 50 x 10	1b 50 x 10	1b 50 x 10	1b 50 x 10	1b 50 x 10	1b 50 x 10	■
	I (A)	630	630	630	630	630	630	630	630	630	630	630	
NS800	Size per phase	1b 50 x 10	1b 50 x 10	1b 50 x 10	1b 50 x 10	1b 50 x 10	1b 50 x 10	1b 50 x 10	1b 50 x 10	1b 50 x 10	1b 50 x 10	1b 50 x 10	■
	I (A)	800	800	800	800	800	800	800	800	800	800	800	
NS1000	Size per phase	1b 50 x 10	1b 50 x 10	1b 50 x 10	1b 50 x 10	1b 50 x 10	1b 50 x 10	1b 50 x 10	1b 50 x 10	1b 50 x 10	1b 50 x 10	1b 50 x 10	■
	I (A)	1000	1000	1000	1000	1000	1000	1000	1000	1000	960	1000	
NS1250	Size per phase	1b 80 x 10	1b 80 x 10	1b 80 x 10	1b 80 x 10	1b 80 x 10	1b 80 x 10	1b 80 x 10	1b 80 x 10	1b 80 x 10	1b 80 x 10	1b 80 x 10	■
	I (A)	1250	1250	1250	1250	1250	1210	1250	1160	1210	1110	1160	
NS1600	Size per phase	1b100 x 10	1b100 x 10	1b100 x 10	1b100 x 10	1b100 x 10	1b100 x 10	1b100 x 10	1b100 x 10	1b100 x 10	1b100 x 10	1b100 x 10	■
	I (A)	1560	1430	1520	1430	1480	1380	1430	1330	1380	1280	1330	

■ Connection impossible due to the operating-temperature limits of the devices installed in the switchboard.

Canalis connection

For Canalis connections, apply the appropriate derating coefficient K.

Device	NS630b	NS800	NS1000	NS1250	NS1600
Derating coefficient K	1	1	1	1	0,98

Note: the values indicated above have been validated for PrismaSeT P Active switchboards.

Designing customer connections

Fixed ComPacT NS630b to NS1000 Horizontal mounting

Electrical characteristics

ComPacT NS630b to NS1000

- Horizontal mounting
- Front connection
- Incoming via top or bottom
- Installation on the left or right

D:\83845.eps

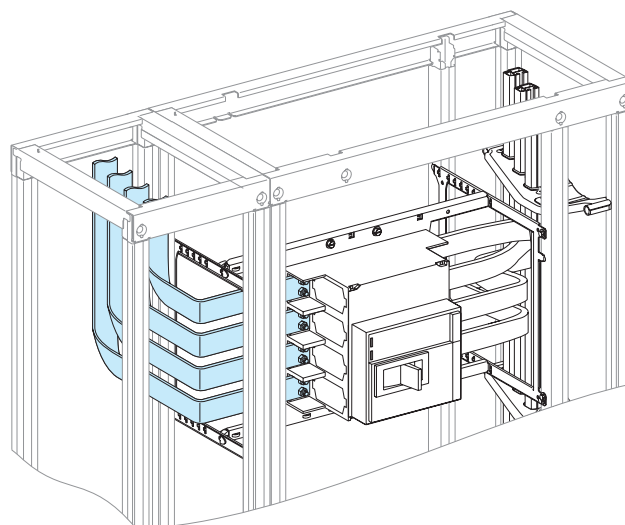

Using the data below, it is possible to determine the size of the copper bars and the maximum permissible currents when making the connections to busbars for a horizontal, fixed ComPacT NS630b/NS1600, taking into account the ambient temperature around the switchboard and the IP value. Connection to be made according to the busbar drawings supplied.

Customer connection

Flat bars, 5 mm thick

Device		Permissible current (A)												
		Ambient temperature around the switchboard												
		25 °C		30 °C		35 °C		40 °C		45 °C		50 °C		
		IP ≤ 31	IP > 31	IP ≤ 31	IP > 31	IP ≤ 31	IP > 31	IP ≤ 31	IP > 31	IP ≤ 31	IP > 31	IP ≤ 31	IP > 31	
NS630b	Size per phase	2b 50 x 5	2b 50 x 5	2b 50 x 5	2b 50 x 5	2b 50 x 5	2b 50 x 5	2b 50 x 5	2b 50 x 5	2b 50 x 5	2b 50 x 5	2b 50 x 5	2b 50 x 5	■
	I (A)	630	630	630	630	630	630	630	630	630	630	630	630	
NS800	Size per phase	2b 50 x 5	2b 50 x 5	2b 50 x 5	2b 50 x 5	2b 50 x 5	2b 50 x 5	2b 50 x 5	2b 50 x 5	2b 50 x 5	2b 50 x 5	2b 50 x 5	2b 50 x 5	■
	I (A)	800	800	800	800	800	800	800	800	800	800	800	800	
NS1000	Size per phase	2b 50 x 5	2b 50 x 5	2b 50 x 5	2b 50 x 5	2b 50 x 5	2b 50 x 5	2b 50 x 5	2b 50 x 5	2b 50 x 5	2b 50 x 5	2b 50 x 5	2b 50 x 5	■
	I (A)	1000	1000	1000	1000	1000	1000	1000	1000	1000	1000	1000	1000	

■ Connection impossible due to the operating-temperature limits of the devices installed in the switchboard.

Flat bars, 10 mm thick

Device		Permissible current (A)												
		Ambient temperature around the switchboard												
		25 °C		30 °C		35 °C		40 °C		45 °C		50 °C		
		1b 50 x 10	1b 50 x 10	1b 50 x 10	1b 50 x 10	1b 50 x 10	1b 50 x 10	1b 50 x 10	1b 50 x 10	1b 50 x 10	1b 50 x 10	1b 50 x 10	1b 50 x 10	■
NS630b	Size per phase	1b 50 x 10	1b 50 x 10	1b 50 x 10	1b 50 x 10	1b 50 x 10	1b 50 x 10	1b 50 x 10	1b 50 x 10	1b 50 x 10	1b 50 x 10	1b 50 x 10	1b 50 x 10	■
	I (A)	630	630	630	630	630	630	630	630	630	630	630	630	
NS800	Size per phase	1b 50 x 10	1b 50 x 10	1b 50 x 10	1b 50 x 10	1b 50 x 10	1b 50 x 10	1b 50 x 10	1b 50 x 10	1b 50 x 10	1b 50 x 10	1b 50 x 10	1b 50 x 10	■
	I (A)	800	800	800	800	800	800	800	800	800	800	800	800	
NS1000	Size per phase	1b 50 x 10	1b 50 x 10	1b 50 x 10	1b 50 x 10	1b 50 x 10	1b 50 x 10	1b 50 x 10	1b 50 x 10	1b 50 x 10	1b 50 x 10	1b 50 x 10	1b 50 x 10	■
	I (A)	1000	1000	1000	1000	1000	1000	1000	1000	1000	1000	1000	1000	

■ Connection impossible due to the operating-temperature limits of the devices installed in the switchboard.

Note: the values indicated above have been validated for PrismaSeT P Active switchboards.

Designing busbars

Fupact GS, ISFT, ISFL Linergy BS busbars

Electrical characteristics

Permissible current and selection of horizontal Linergy BS busbars

The goal is to optimise busbar size according to the installation and operating criteria.

Horizontal Linergy BS busbars

Fupact GS/ISFT/ISFL

Linergy BS bars, 5 mm thick

Type of bars	Permissible current (A)											
	Ambient temperature around the switchboard											
	25 °C		30 °C		35 °C		40 °C		45 °C		50 °C	
Size per phase	IP ≤ 31	IP > 31	IP ≤ 31	IP > 31	IP ≤ 31	IP > 31	IP ≤ 31	IP > 31	IP ≤ 31	IP > 31	IP ≤ 31	IP > 31
1 Linergy BS bar, 60 x 5	800	750	760	700	710	650	660	600	610	550	560	■
1 Linergy BS bar, 80 x 5	1000	910	970	860	910	810	860	750	810	700	750	■
2 Linergy BS bars, 60 x 5	1400	1250	1320	1160	1250	1070	1160	980	1070	880	980	■
2 Linergy BS bars, 80 x 5	1700	1500	1600	1400	1500	1280	1400	1160	1280	1030	1160	■

■ Connection impossible due to the operating-temperature limits of the devices installed in the switchboard.

Linergy BS bars, 10 mm thick

Type of bars	Permissible current (A)											
	Ambient temperature around the switchboard											
	25 °C		30 °C		35 °C		40 °C		45 °C		50 °C	
Size per phase	IP ≤ 31	IP > 31	IP ≤ 31	IP > 31	IP ≤ 31	IP > 31	IP ≤ 31	IP > 31	IP ≤ 31	IP > 31	IP ≤ 31	IP > 31
1 Linergy BS bar, 50 x 10	1150	1000	1080	930	1000	850	930	760	850	670	760	■
1 Linergy BS bar, 60 x 10	1400	1250	1320	1160	1250	1070	1160	980	1070	880	980	■
1 Linergy BS bar, 80 x 10	1700	1500	1600	1400	1500	1280	1400	1160	1280	1030	1160	■
2 Linergy BS bars, 50 x 10	1940	1690	1840	1560	1700	1420	1560	1270	1420	1100	1270	■
2 Linergy BS bars, 60 x 10	2170	1900	2040	1750	1900	1590	1750	1420	1590	1240	1420	■
2 Linergy BS bars, 80 x 10	2670	2340	2500	2160	2340	1970	2160	1770	1970	1550	1770	■
2 Linergy BS bars, 100 x 10	3120	2750	2930	2520	2750	2310	2520	2070	2310	1820	2070	■

■ Connection impossible due to the operating-temperature limits of the devices installed in the switchboard.

Rear horizontal Linergy BS bars

Fupact ISFT/ISFL

Linergy BS bars, 10 mm thick

Device	Size per phase	Permissible current (A)											
		Ambient temperature around the switchboard											
		25 °C		30 °C		35 °C		40 °C		45 °C		50 °C	
		IP ≤ 31	IP > 31	IP ≤ 31	IP > 31	IP ≤ 31	IP > 31	IP ≤ 31	IP > 31	IP ≤ 31	IP > 31	IP ≤ 31	IP > 31
ISFT 160	1 bar Linergy BS 30 x 10	730	680	680	630	630	570	570	510	510	450	450	■
ISFL 160	1 bar Linergy BS 60 x 10	1400	1250	1320	1160	1250	1070	1160	980	1070	880	980	■
	1 bar Linergy BS 80 x 10	1700	1500	1600	1400	1500	1280	1400	1160	1280	1030	1160	■
ISFL 250/400/630	1 bar Linergy BS 80 x 10	1700	1500	1600	1400	1500	1280	1400	1160	1280	1030	1160	■
	1 bar Linergy BS 100 x 10	2050	1800	1930	1680	1800	1540	1680	1400	1540	1240	1400	■
	1 bar Linergy BS 120 x 10	2390	2100	2250	1950	2100	1800	1950	1630	1800	1440	1630	■

■ Connection impossible due to the operating-temperature limits of the devices installed in the switchboard.

Designing busbars

Fupact GS, ISFT Vertical Linergy LGYE, LGY busbars

Electrical characteristics

Permissible current and selection of Linergy LGYE busbars

The goal is to optimise busbar size according to the installation and operating criteria.

Vertical Linergy LGYE busbars

Fupact GS/ISFT

Type of bars	Permissible current (A)											
	Ambient temperature around the switchboard											
	25 °C		30 °C		35 °C		40 °C		45 °C		50 °C	
Size per phase	IP ≤ 31	IP > 31	IP ≤ 31	IP > 31	IP ≤ 31	IP > 31	IP ≤ 31	IP > 31	IP ≤ 31	IP > 31	IP ≤ 31	IP > 31
Linergy LGYE 630	650	550	630	510	590	480	550	460	530	440	460	■
Linergy LGYE 800	840	720	800	700	760	660	720	610	680	580	640	■
Linergy LGYE 1000	1040	900	990	870	950	830	900	770	850	730	800	■
Linergy LGYE 1250	1290	1120	1230	1080	1170	1030	1100	970	1050	910	980	■
Linergy LGYE 1600	1580	1390	1480	1320	1390	1250	1320	1180	1250	1110	1180	■
Linergy LGYE 2000	1900	1720	1820	1620	1720	1520	1620	1420	1520	1320	1420	■
Linergy LGYE 2500	2290	1890	2190	1840	2070	1770	1960	1680	1880	1590	1780	■
Linergy LGYE 3200	3060	2780	2920	2640	2780	2500	2640	2360	2500	2220	2360	■
Linergy LGYE 4000	3320	3050	3240	2950	3140	2850	2970	2700	2800	2540	2650	■

■ Connection impossible due to the operating-temperature limits of the devices installed in the switchboard.

Lateral Linergy LGY busbars

Fupact GS/ISFT

Type of bars	Permissible current (A)											
	Ambient temperature around the switchboard											
	25 °C		30 °C		35 °C		40 °C		45 °C		50 °C	
Size per phase	IP ≤ 31	IP > 31	IP ≤ 31	IP > 31	IP ≤ 31	IP > 31	IP ≤ 31	IP > 31	IP ≤ 31	IP > 31	IP ≤ 31	IP > 31
Linergy LGY 630	680	590	630	550	590	530	550	500	530	460	460	■
Linergy LGY 800	840	760	800	720	760	680	720	640	680	600	640	■
Linergy LGY 1000	1040	950	990	900	950	850	900	800	850	750	800	■
Linergy LGY 1250	1290	1170	1230	1100	1170	1030	1100	970	1050	910	980	■
Linergy LGY 1600	1580	1390	1480	1320	1390	1250	1320	1180	1250	1110	1180	■
Linergy LGY 2000 (2 x 1000)	1900	1720	1820	1620	1720	1520	1620	1420	1520	1320	1420	■
Linergy LGY 2500 (2 x 1250)	2380	2120	2260	2020	2120	1900	2020	1780	1900	1660	1780	■
Linergy LGY 3200 (2 x 1600)	3060	2780	2920	2640	2780	2500	2640	2360	2500	2220	2360	■

■ Connection impossible due to the operating-temperature limits of the devices installed in the switchboard.

Designing busbars

Fupact GS, ISFT Vertical Linergy BS busbars

Electrical characteristics

Lateral Linergy BS busbars

Fupact GS/ISFT

Linerigy BS bars, 5 mm thick

Type of bars	Permissible current (A)											
	Ambient temperature around the switchboard											
	25 °C		30 °C		35 °C		40 °C		45 °C		50 °C	
Size per phase	IP ≤ 31	IP > 31	IP ≤ 31	IP > 31	IP ≤ 31	IP > 31	IP ≤ 31	IP > 31	IP ≤ 31	IP > 31	IP ≤ 31	IP > 31
1 Linergy BS bar, 60 x 5	800	750	760	700	710	650	660	600	610	550	560	■
1 Linergy BS bar, 80 x 5	1000	910	970	860	910	810	860	750	810	700	750	■
2 Linergy BS bars, 60 x 5	1400	1250	1320	1160	1250	1070	1160	980	1070	880	980	■
2 Linergy BS bars, 80 x 5	1700	1500	1600	1400	1500	1280	1400	1160	1280	1030	1160	■

■ Connection impossible due to the operating-temperature limits of the devices installed in the switchboard.

Linerigy BS bars, 10 mm thick

Type of bars	Permissible current (A)											
	Ambient temperature around the switchboard											
	25 °C		30 °C		35 °C		40 °C		45 °C		50 °C	
Size per phase	IP ≤ 31	IP > 31	IP ≤ 31	IP > 31	IP ≤ 31	IP > 31	IP ≤ 31	IP > 31	IP ≤ 31	IP > 31	IP ≤ 31	IP > 31
1 Linergy BS bar, 50 x 10	1150	1000	1080	930	1000	850	930	760	850	670	760	■
1 Linergy BS bar, 60 x 10	1400	1250	1320	1160	1250	1070	1160	980	1070	880	980	■
1 Linergy BS bar, 80 x 10	1700	1500	1600	1400	1500	1280	1400	1160	1280	1030	1160	■
2 Linergy BS bars, 50 x 10	1940	1690	1810	1560	1700	1420	1560	1270	1420	1100	1270	■
2 Linergy BS bars, 60 x 10	2170	1900	2040	1750	1900	1590	1750	1420	1590	1240	1420	■
2 Linergy BS bars, 80 x 10	2670	2340	2500	2160	2340	1970	2160	1770	1970	1550	1770	■
2 x 1 Linergy BS bar, 80 x 10	3020	2650	2840	2450	2650	2230	2450	2010	2230	1760	2010	■

■ Connection impossible due to the operating-temperature limits of the devices installed in the switchboard.

Designing connections ≤630A

TransferPacT Active Automatic/Automatic/Remote 250A & 630A

Insulated flexible copper bars ⁽¹⁾

Electrical characteristics

TransferPacT 250A & 630A

Insulated flexible copper bars (withstand temperature = 125 °C)

We recommend insulated flexible copper bars for TransferPacT 250A & 630A.

Vertical Mounting

Front Connection

Incoming Top Connection - Cable

Outgoing Bottom Connection - Flexible Busbar

Installation on the left or right LGY/LGYE

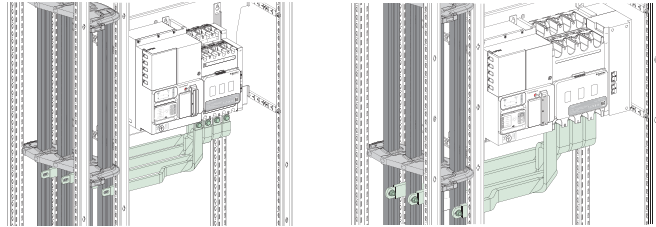

Outgoing connection

Flexible Busbar Flat 3 mm (250A) & 8 mm (630A) Thick

Device	Permissible current (A)												
	Ambient temperature around the switchboard												
	25 °C		30 °C		35 °C		40 °C		45 °C		50 °C		
Cable Size	IP ≤ 31	IP > 31	IP ≤ 31	IP > 31	IP ≤ 31	IP > 31	IP ≤ 31	IP > 31	IP ≤ 31	IP > 31	IP ≤ 31	IP > 31	
TransferPacT 250A	Size per phase (mm ²)	1b 20X3	1b 20X3	1b 20X3	1b 20X3	1b 20X3	1b 20X3	1b 20X3	1b 20X3	1b 20X3	1b 20X3	1b 20X3	1b 20X3
	I(A)	250	250	250	250	250	240	250	230	240	220	225	208
TransferPacT 630A	Size per phase (mm ²)	1b 32X8	1b 32X8	1b 32X8	1b 32X8	1b 32X8	1b 32X8	1b 32X8	1b 32X8	1b 32X8	1b 32X8	1b 32X8	1b 32X8
	I(A)	580	545	565	525	545	505	525	490	505	475	490	430

Note: The values indicated above have been validated for PrismaSeT P Active switchboards.

⁽¹⁾ We recommend insulated flexible copper bars instead of copper cable for TransferPacT 250A to 630A outgoing connection.

Selection of enclosures according to the premises

Enclosure characteristics

The IP and IK degrees of protection provided by an enclosure must be specified as a function of the various external influences defined by standard IEC 30364-5-51, in particular:

- presence of foreign solid bodies (code AE)
- presence of water (code AD)
- mechanical stress (code not specified)
- capability of persons (code BA)
- ...

PrismaSeT P Active switchboards are designed for indoor installation.

Unless the rules, standards and regulations of a specific country stipulate otherwise, Schneider Electric recommends the following IP and IK values based on French guide UTE C 15-103 (March 2004).

Using the table

- 1 Opposite the relevant premises, read the recommended IP and IK values.
- 2 The ■ symbol indicates the enclosure or cubicle satisfying the criteria of the UTE guide.
Any enclosure or cubicle with a higher degree of protection can also be used.
- 3 If several degrees of protection are possible (refer to the standard for more details) and the □ and ■ symbols are indicated (e.g. 24[□]/25[■]), enclosures that correspond to the higher degree of protection (■) are suitable for the lower degree of protection (□).

Type of premises	Enclosure						
	Cubicle		with fixed frame	with door + IP30 cover	with door + gasket + IP30 cover	with door + IP55 cover	
	Min. IP/IK required	IP30/IK07					IP30/IK08
IP	IK						
Domestic or comparable premises or locations							
Porch	24	07					■
Bathrooms (see washrooms)							
Bicycles, motorcycles, tricycles, etc. (premises for)	20	07	■				
Water, sewer and heating connections	23	02				■	
Laundries	21	02			■		
Cellars, garages, furnace rooms	20	02/07	■				
Bedrooms	20	02	■				
Trash rooms	25	07					■
Halls in cellars	20	07					
Courtyards	24/25	02/07					■
Kitchens	20	02	■				
Shower rooms (see washrooms)							
Indoor stairways and alleys	20	02/07	■				
Outdoor stairways and outdoor alleys without roofs	24	07					
Outdoor alleys with roofs	21	02			■		
Attics (roof space)	20	02	■				
Garden shelters	24/25	02/07					■
Latrines	20	02	■				
Dustbin rooms	25	02/07					■
Ironing room	20	02	■				
Access ramps to garages	25	07					■

■ No applicable

Selection of enclosures according to the premises

Enclosure characteristics

Type of premises		Enclosure							
		Cubicle		with fixed frame	with door + IP30 cover	with door + gasket + IP30 cover	with door + IP55 cover		
		Min. IP/IK required		IP30/IK07	IP30/IK08	IP31/IK08	IP43/IK08	IP55/IK10	
		IP	IK						
Washrooms, rooms containing a bathtub or shower	volume 0	27	02						
	volume 1	24	02					■	
	volume 2	23	02				■		
	volume 3	21	02			■			
Lounges, living rooms, etc		20	02	■					
Drying rooms		21	02			■			
Covered terraces		21	02			■			
WCs		20	02	■					
Verandas		20	02	■					
Crawl spaces		23	07						
Commercial premises and adjoining areas									
Gunsmiths (storage area, workshop)		30	08		■				
Laundries (wash room)		24	07					■	
Butchers	shop	24	07					■	
	cold room ≤ -10 °C	23	07				■		
Bakers, cake shops (kitchens)		50	07					■	
Coffee roasters		21	02			■			
Coal, wood, oil		20	08		■				
Delicatessen (production)		24	07					■	
Sweets (production)		20	02	■					
Shoe repair shops		20	02	■					
Dairies		24	02					■	
Hardware stores (storage areas for chemicals and paint)		33	07				■		
Wood workers		50	07					■	
Art galleries		20	02/07	■					
Florists		24	07					■	
Furriers		20	07	■					
Fruit and vegetable merchants		24	07					■	
Grain shops		50	07					■	
Bookshops, stationers		20	02	■					
Motorcycle and bicycle repairs and accessories		20	08		■				
Messenger services		20	08		■				
Furniture shops (antiques, secondhand)		20	07	■					
Glass and mirror merchants (workshop)		20	07	■					
Wallpaper shop (storage area)		20	07	■					
Cosmetics shop (storage area)		20	02	■					
Chemists (storage area)		20	02	■					
Photographers (dark room)		23	02				■		
Plumbers (storage area)		20	08		■				
Fishmongers		25	07					■	
Dry cleaners		23	02				■		
Hardware stores (without paint, chemicals, etc.)		20	07	■					
Locksmiths		20	07 ² /08 ²	■	■				
Vintners, spirits		20	07	■					
Interior decorator (carding)		50	07					■	
Tailors, clothing retailers (storage area)		20	02	■					
Pet care		35	07					■	

No applicable

Selection of enclosures according to the premises

Enclosure characteristics

Type of premises		Enclosure						
		Cubicle		with fixed frame IP30/IK07	with door + IP30 cover IP30/IK08	with door + gasket + IP30 cover IP31/IK08	IP43/IK08	with door + IP55 cover IP55/IK10
		Min. IP/IK required						
IP	IK							
Shared premises of buildings open to the general public	storage rooms	20	08		■			
	packing rooms	20	08		■			
	archive rooms	20	02	■				
	film and magnetic media storage	20	02	■				
	linen rooms	20	02	■				
	laundry rooms	24	07					■
	misc. shops	21	07/08			■		
	kitchens (large)							
J	Reception old and handicapped people	20	02	■				
L	Lecture halls, meeting rooms, auditoriums, halls used for several purposes	halls	20	02/07	■			
		stage areas	20	08		■		
		scenery storage rooms	20	08		■		
		costume rooms	20	07	■			
M	Retail premises, shopping malls	sales premises	20	08		■		
		areas for storage and handling of packing	20	08		■		
N	Restaurants and cafes	20	08		■			
O	Hotels and boarding houses	20	02	■				
P	Dance halls and gaming parlours	20	07	■				
R	Teaching establishments, holiday camps	classrooms	20	02	■	■		
		dormitories	20	08		■		
S	Libraries and documentation centres		20	02	■			
			20	02	■			
T	Exhibitions	halls and rooms	20	02	■			
		areas for reception of equipment and merchandise	20	07	■			
U	Healthcare establishments	bedrooms	20	02	■			
		incineration	21	07/08			■	
		operating rooms	20	07	■			
		centralised sterilisation	24	02/07				■
	pharmacies and labs with more than 10 l of inflammable liquids	21 ² /23 ²	02 ² /07 ²			■	■	
V	Places of worship	20	02	■				
W	Administrative premises, banks	20	02	■				
X	Indoor sports facilities	halls	20	07 ² /08 ²	■	■		
		premises containing refrigeration facilities	21	08			■	
Y	Museums	20	02	■				
PA	Covered open air facilities	23 ² /25 ²	08 ² /10 ²				■	
CTS	Marquees and tents	44	08				■	
SG	Inflatable structures	44	08				■	
PS	Covered parking lots	21	08 ² /10 ²			■	■	

Selection of enclosures according to the premises

Enclosure characteristics

Type of premises	Enclosure						
	Cubicle		with fixed frame	with door + IP30 cover	with door + gasket + IP30 cover		with door + IP55 cover
	Min. IP/IK required		IP30/IK07	IP30/IK08	IP31/IK08	IP43/IK08	IP55/IK10
	IP	IK					
Technical premises							
Battery rooms	23	02/07				■	
Lifts (machine rooms and pulley rooms)	20	07 [□] /08 [■]	■	■			
Electrical rooms	20	07	■				
Control rooms	20	02	■				
Workshops	21 [□] /23 [■]	07 [□] /08 [■]			■	■	
Laboratories	21 [□] /23 [■]	02 [□] /07 [■]			■	■	
Air conditioning washers	24	07					■
Garages (used exclusively for parking vehicles) of an area not exceeding 100 m ²	21	07			■		
Machine rooms	31	07/08			■		
Water pressurisers	23	07/08				■	
Boiler houses and adjoining premises (power in excess of 70 kW)							
Boiler rooms	coal fuel	51 [□] /61 [■]	07 [□] /08 [■]				■
	other fuel	21	07/08			■	
	electrical	21	07/08			■	
Fuel storage areas	coal	50 [□] /60 [■]	08				■
	oil	20	07 [□] /08 [■]	■	■		
	liquefied gas	20	07 [□] /08 [■]	■	■		
Cinder tips	50	08					■
Pump rooms	21 [□] /23 [■]	07 [□] /08 [■]			■	■	
Pressure reduction rooms (gas)	20	07 [□] /08 [■]	■	■			
Steam or hot water facilities	21 [□] /23 [■]	07 [□] /08 [■]			■	■	
Expansion vessel room	21	02			■		
Garages and car parks of an area exceeding 100 m²							
Parking lots	21	07 [□] /10 [■]			■		■
Carwash areas (inside premises)	25	07					■
Petrol stations	inside	21	07			■	
	outside						
Lubrication areas	23	08				■	
Battery recharging areas	23	07				■	
Workshops	21	08			■		
Public building (other than for the general public)							
Offices	20	02	■				
Libraries	20	02	■				
Archives	20	02	■				
Computer rooms	20	02	■				
Design offices	20	02	■				
Rooms containing reprographic machines	20	02	■				
Sorting rooms	20	07	■				
Refectories in restaurants or canteens	21	07			■		
Large kitchens							
Sports rooms	20	07 [□] /08 [■]	■	■			
Barracks	20	07	■				
Meeting rooms	20	02	■				
Waiting rooms, lounges, halls	20	02	■				
Medical consulting rooms, not fitted with specific equipment	20	02	■				
Demonstration and exhibition rooms	20	02/07	■				

No applicable

Selection of enclosures according to the premises

Enclosure characteristics

Type of premises	Enclosure						
	Cubicle		with fixed frame	with door + IP30 cover	with door + gasket + IP30 cover		with door + IP55 cover
	Min. IP/IK required		IP30/IK07	IP30/IK08	IP31/IK08	IP43/IK08	IP55/IK10
	IP	IK					
Farm premises or locations							
Alcohol (storage)	23	07				■	
Closed cattle sheds	35	07					■
Laundries	24	07					■
Wood storage rooms	30	10					■
Threshing floors	50	07					■
Distilling cellars	23	07				■	
Vat rooms (wine)	23	07				■	
Courtyards	35	07					■
Poultry barns	35	07					■
Stables	35	07					■
Fertiliser (storage)	50	07					■
Stables	35	07					■
Manure heaps	24	07					■
Haylofts	50	07					■
Haystacks, forage (storage)	50	07					■
Granaries, barns	50	07					■
Straw (storage)	50	07					■
Greenhouses	23	07				■	
Grain silos	50	07					■
Milking rooms	35	07					■
Pig sties	35	07					■
Chicken houses	35	07					■
Miscellaneous installations							
Fair facilities	33	08				■	
Water treatment facilities	24/25	07/08					■
Thermodynamic installations, air-conditioned rooms and cold rooms							
Height above ground	from 0 to 1.10 m	25	07				■
	from 1.10 to 2 m	24	07				■
	above 2 m under evaporator or water drain pipe	21	07			■	
	ceiling and up to 10 cm underneath	23	07				■
Temperature ≤ -10 °C		23	07			■	
Compressor	room	21	08			■	
	integral unit located outside or on a terrace	34	08				

No applicable

Selection of enclosures according to the premises

Enclosure characteristics

Type of premises	Enclosure						
	Cubicle		with fixed frame	with door + IP30 cover	with door + gasket + IP30 cover	IP43/IK08	with door + IP55 cover
	Min. IP/IK required		IP30/IK07	IP30/IK08	IP31/IK08		IP55/IK10
	IP	IK					
Industrial facilities							
Slaughter houses	55	08					■
Batteries (manufacture)	33	07				■	
Acid (manufacture and storage)	33	07				■	
Alcohol (manufacture and storage)	33	07				■	
Aluminium (manufacture and storage)	51	08					■
Livestock (raising, fattening and sale)	45	07					■
Asphalt and bitumen storage	53	07					■
Wool beating and carding	50	08					■
Industrial laundry	24/25	07					■
Wood (processing)	50	08					■
Meat packers	24/25	07					■
Bakeries	50	07					■
Breweries	24	07					■
Brickworks	53	08					■
Rubber (production and processing)	54	07					■
Carbide (manufacture and storage)	51	07				■	■
Ammunition factories	53	08					■
Carton board (production)	33	07				■	
Quarries	55	08					■
Celluloid (manufacture of objects)	30	08		■			
Cellulose (manufacture)	34	08					■
Coal (depots)	53	08					■
Pork products	24/25	07					■
Boiler-making works	30	08		■			
Lime kilns	50	08					■
Rag (storage)	30	07	■				
Chlorine (manufacture and storage)	33	07				■	
Chrome-plating	33	07				■	
Cement works	50	08					■
Coking plant	53	08					■
Adhesives (production)	33	07					■
Bottling lines	35	08					■
Liquid fuels (storage)	31 [□] /33 [■]	08			■		
Fats (processing)	51	07					■
Leather (tanning and storage)	31	08			■		
Copper (ore processing)	31	08			■		
Paint stripping	54	08				■	■
Detergents (manufacture)	53	07				■	■
Distilleries	33	07				■	
Electrolysis	33	08				■	
Ink manufacturing	31	07			■		■
Fertilisers (manufacture and storage)	53	07					■
Explosives (manufacture and storage)	55	08					■
Iron (production and processing)	51	08					■
Spinning mills	50	07					■
Furriers (beating process)	50	07					■
Cheese factories	25	07					■
Gas (production and storage)	31	08			■		
Tar (processing)	33	05				■	
Seed production	50	07					■
Metal engraving	33	07				■	
Oils (extraction)	31	07			■		
Petroleum products (manufacture)	33 [□] /34 [■]	08				■	■
Printworks	20	08					

Selection of enclosures according to the premises

Enclosure characteristics

Type of premises	Enclosure						
	Cubicle		with fixed frame	with door + IP30 cover	with door + gasket + IP30 cover		with door + IP55 cover
	Min. IP/IK required		IP30/IK07	IP30/IK08	IP31/IK08	IP43/IK08	IP55/IK10
	IP	IK					
Industrial establishments (continued)							
Dairies	25	07					■
Public wash-houses	25	07					■
Liqueurs (production)	21	07			■		
Halogenated liquids (use)	21	08			■		
Inflammable products (storage and workshops where they are used)	21	08			■		
Magnesium (production, storage and use)	31	08			■		
Machine rooms	20	08		■			
Plastics (production)	51	08					■
Cabinet makers	50	08					■
Metals (processing)	31 [□] /33 [■]	08			■	■	
Combustion engines (testing of)	30	08		■			
Ammunition storage	33	08				■	
Nickel (or processing)	33	08				■	
Household waste (processing)	54	07					■
Paper (production)	33 [□] /34 [■]	07			■	■	■
Paper (storage)	31	07			■		
Perfume (production and storage)	31	07			■		
Pulp mill	34/35	07				■	■
Paint (production and storage)	33	08				■	
Plaster (processing and storage)	50	07					■
Gunpowder factory	55	08					■
Chemicals (production)	30 [□] /50 [■]	08		■			■
Oil refineries	34/35	07					■
Salt preserve factories	33	07				■	
Soap (production)	31	07			■		
Saw mills	50	08					■
Metalwork shops	30	08		■			
Grain or sugar silos	50	07					■
Silk and artificial hair factories	50	08					■
Sodium carbonate (processing and storage)	33	07				■	
Sulphur (processing)	51	07					■
Spirits (storage)	33	07				■	
Sugar mills	55	07				■	■
Tanners	35	07					■
Dye works	35	07					■
Textile and fabric (production)	51	08					■
Varnish (production and application)	33	08				■	
Glass works	33	08				■	
Zinc works	31	08			■		

No applicable

Designing connections between a device and busbars

Dedicated cubicle - W = 400 mm

Electrical characteristics

Fixed MasterPacT / MTZ1 06 to 16
 Fixed ComPacT NS630b to NS1600

Dedicated cubicle
 Linergy LGYE, BS busbars
 Connections drawings supplied by Schneider Electric

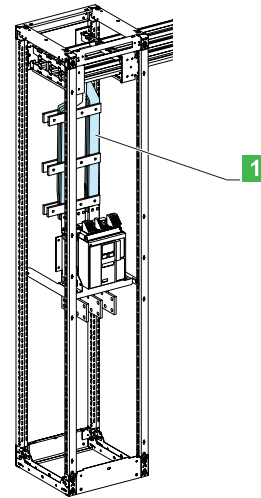

1 Connection

Connection

Flat bars, 10 mm thick

Device		Permissible current (A)												
		Ambient temperature (°C)												
		25 °C		30 °C		35 °C		40 °C		45 °C		50 °C		
Fixed NS, MTZ1/NT		IP ≤ 31	IP > 31	IP ≤ 31	IP > 31	IP ≤ 31	IP > 31	IP ≤ 31	IP > 31	IP ≤ 31	IP > 31	IP ≤ 31	IP > 31	
NS 630, NT 630 & MTZ1 630	Size per phase	1b 50x10	1b 50x10	1b 50x10	1b 50x10	1b 50x10	1b 50x10	1b 50x10	1b 50x10	1b 50x10	1b 50x10	1b 50x10	1b 50x10	■
	Fixed I (A)	630	630	630	630	630	630	630	630	630	630	630	630	
NS 800, NT 800 & MTZ1 800	Size per phase	1b 50x10	1b 50x10	1b 50x10	1b 50x10	1b 50x10	1b 50x10	1b 50x10	1b 50x10	1b 50x10	1b 50x10	1b 50x10	1b 50x10	■
	Fixed I (A)	800	800	800	800	800	800	800	800	800	800	800	800	
NS 1000, NT 1000 & MTZ1 1000	Size per phase	1b 50x10	1b 50x10	1b 50x10	1b 50x10	1b 50x10	1b 50x10	1b 50x10	1b 50x10	1b 50x10	1b 50x10	1b 50x10	1b 50x10	■
	Fixed I (A)	1000	1000	1000	1000	980	940	960	920	940	900	920		
NS 1250, NT 1250 & MTZ1 1250	Size per phase	1b 50x10	1b 50x10	1b 50x10	1b 50x10	1b 50x10	1b 50x10	1b 50x10	1b 50x10	1b 50x10	1b 50x10	1b 50x10	1b 50x10	■
	Fixed I (A)	1240	1080	1200	1050	1160	1020	1125	980	1085	950	1040		
NS 1600, NT 1600 & MTZ1 1600	Size per phase	2b 50x10	2b 50x10	2b 50x10	2b 50x10	2b 50x10	2b 50x10	2b 50x10	2b 50x10	2b 50x10	2b 50x10	2b 50x10	2b 50x10	■
	Fixed I (A)	1525	1380	1490	1345	1450	1310	1415	1275	1375	1240	1330		

■ Connection impossible due to the operating-temperature limits of the devices installed in the switchboard.

Designing connections between a device and busbars

Dedicated cubicle - W = 400 mm

Electrical characteristics

Drawout MasterPacT / MTZ1 06 to 16
 Drawout ComPacT NS630b to NS1600

Dedicated cubicle
 Linergy LGYE, BS busbars
 Connections drawings supplied by Schneider Electric

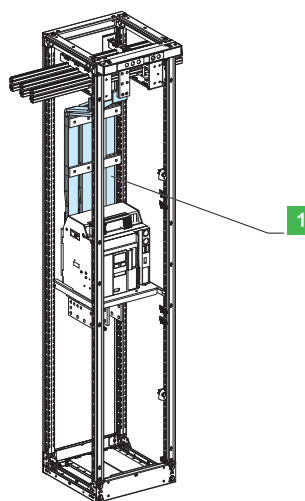

1 Connection

Connection

Flat bars, 10 mm thick

Device		Permissible current (A)												
		Ambient temperature (°C)												
		25 °C		30 °C		35 °C		40 °C		45 °C		50 °C		
Drawout NS, MTZ1/NT		IP ≤ 31	IP > 31	IP ≤ 31	IP > 31	IP ≤ 31	IP > 31	IP ≤ 31	IP > 31	IP ≤ 31	IP > 31	IP ≤ 31	IP > 31	
NS 630, NT 630 & MTZ1 630	Size per phase	1b 50x10	1b 50x10	1b 50x10	1b 50x10	1b 50x10	1b 50x10	1b 50x10	1b 50x10	1b 50x10	1b 50x10	1b 50x10	1b 50x10	■
	Drawout A (l)	630	630	630	630	630	630	630	630	630	630	630	630	
NS 800, NT 800 & MTZ1 800	Size per phase	1b 50x10	1b 50x10	1b 50x10	1b 50x10	1b 50x10	1b 50x10	1b 50x10	1b 50x10	1b 50x10	1b 50x10	1b 50x10	1b 50x10	■
	Drawout A (l)	800	800	800	800	800	800	800	800	800	800	800	800	
NS 1000, NT 1000 & MTZ1 1000	Size per phase	1b 50x10	1b 50x10	1b 50x10	1b 50x10	1b 50x10	1b 50x10	1b 50x10	1b 50x10	1b 50x10	1b 50x10	1b 50x10	1b 50x10	■
	Drawout A (l)	1000	1000	1000	1000	980	940	960	920	940	900	920		
NS 1250, NT 1250 & MTZ1 1250	Size per phase	1b 50x10	1b 50x10	1b 50x10	1b 50x10	1b 50x10	1b 50x10	1b 50x10	1b 50x10	1b 50x10	1b 50x10	1b 50x10	1b 50x10	■
	Drawout A (l)	1230	1070	1190	1040	1155	1005	1115	970	1075	935	1030		
NS 1600, NT 1600 & MTZ1 1600	Size per phase	2b 50x10	2b 50x10	2b 50x10	2b 50x10	2b 50x10	2b 50x10	2b 50x10	2b 50x10	2b 50x10	2b 50x10	2b 50x10	2b 50x10	■
	Drawout A (l)	1515	1340	1480	1305	1440	1270	1400	1235	1355	1200	1315		

■ Connection impossible due to the operating-temperature limits of the devices installed in the switchboard.

After sales tools

Contents

Practical information

Tools required for mounting and connection	J-2
Connection of horizontal to vertical busbars	J-3
Installation of the current transformer	J-4
Installation of source changeover systems	J-6
Storage recommendations	J-8
Packing information	J-9
Handling on the site	J-10
Transport	J-12
Cubicle handling and rolling base Lifting reinforcement kit for combined cubicles	J-13
Connection of busbar trunking	J-14
Connection of power cables	J-15

Maintenance

Preventive maintenance	J-18
Corrective maintenance	J-20

Tools required for mounting and connection

Practical information

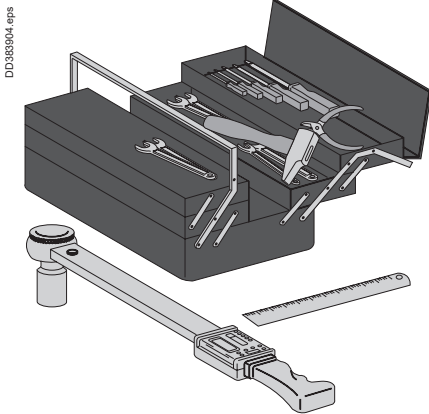

- Vacuum cleaner to clean the switchboards
- Ratchet wrench with sockets
- Torque wrench with sockets and ring bits to tighten the electrical connections to the correct torque (max. torque 50 Nm)
- Open-ended torque wrench
- Open-ended spanners (15 to 27 mm).
- Electrician's knife
- 7, 8, 10, 13, 16, 17 and 19 mm sockets
- Bit holder socket
- 4, 5, 6, 8 and 10 mm hexagonal-head bits
- Pozidriv no. 1, 2 and 3 bits
- Rubber mallet
- Level.
- Measurement and inspection tools and instruments
- Drill
- Semi-circuit nosed pliers
- Cable-tie pliers
- Wire stripper
- Crimping tool
- Diagonal cutter
- Wire cutters
- Flat-nosed pliers
- Bit holder for screwdriver
- Extension
- Electric saw
- Jig saw
- Clamp for cubicle alignment
- Buzzer or tester
- 3, 5, 4, 5.5 and 8 mm flat screwdrivers
- Posidriv no. 2 crosshead screwdriver (to mount handle)
- Hydraulic jacks that can be operated in horizontal position to lift cubicles and move them sideways if necessary.
- Coloured, indelible and temperature resistant acrylic varnish.
- Electric screwdriver

Note: a Facom brand torque wrench is available with a capacity of 75 Nm and a thin shape. It is recommended for tightening under difficult access conditions.

Part numbers:

- SP3723 = wrench handle (essential)
- SP3721 = extra-flat ratchet adapter (essential)
- SP3722 = ratchet for ordinary sockets (optional) for mounting on handle SP3723
- SP2709 = extra-flat 13 mm short socket
- SP2709A = extra-flat 13 mm long socket
- SP4369 = extra-flat 16 mm short socket
- SP4370 = extra-flat 16 mm long socket
- SP2710 = extra-flat 17 mm short socket
- SP4371 = extra-flat 19 mm short socket
- SP4372 = extra-flat 19 mm long socket.

Connection of horizontal to vertical busbars

Practical information

Horizontal busbars can be connected to vertical busbars (Linergy LGY or Linergy BS) in two ways:

- in a duct (by a direct connection ordered from the Catalog)
- in the rear (with part of the connection to be fabricated by the installer).

5 mm thick horizontal busbars can be connected to vertical busbars using connection plate LVS04634 (y 1000 A) or LVS04635 (> 1000 A) after drilling holes in the horizontal bars.

10 mm thick horizontal busbars can be connected to vertical busbars in 2 ways:

- using connection plate LVS04636 (≤ 1600 A) or 1600 A < LVS04637 < 2820 A without drilling holes in the horizontal bars
- or with a screw and socket assembly (LVS04645) designed for assembly on a busbar that has already been mounted.

This bolted solution requires:

- holes drilled in the bars ($\varnothing 16$ mm) for diagonal mounting of the sockets and screws
- conformity with the following mounting rules:
 - respect the overlap length (2.5 to 5 times the bar thickness)
 - tighten to a torque of 50 Nm
 - fit the recommended number of screws, depending on the bar width as explained below.

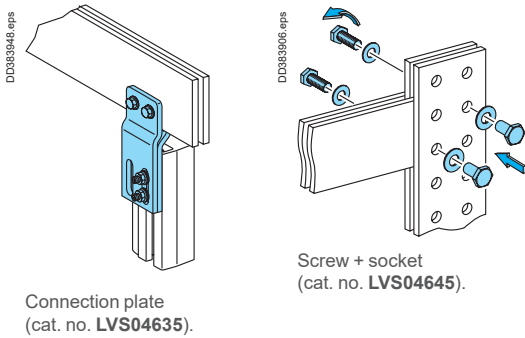

Connection plate (cat. no. LVS04635).

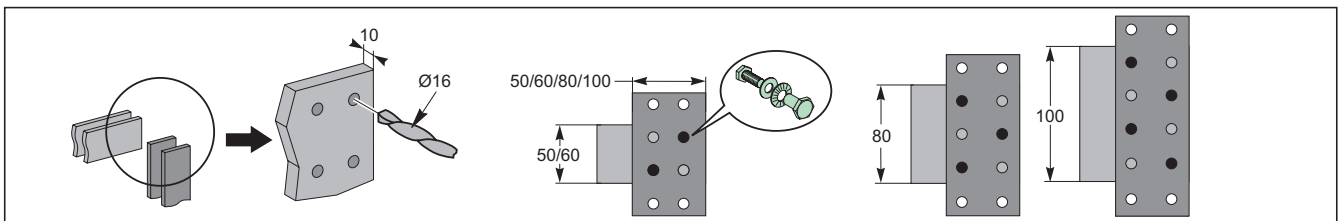

Overlap (mm)	50	60	80	100	120
50/60	x2	—	—	—	—
80	x3	—	—	—	—
100	x4	—	—	—	—
120	x4	—	—	—	—

In practice, the real contact area is limited to regions in which the pressure is applied effectively. In a bolted overlap assembly, these areas are made up of the areas adjacent to the bolts, and more precisely under the washers. Salt spray tests have demonstrated these contact areas. The number of screws thus determines the effective cross-sectional area through which the current flows, which corresponds to the area under the washer (minus the screw hole). This cross-section area must be close to that of the bar.

Controlled temperature rise

Whatever the connection solution used, the quality and reliability of the contact is guaranteed, in particular with respect to temperature rise, as long as assembly is carried out according to our recommendations.

Installation of the current transformer

Practical information



Dismountable vertical busbars.

Choice of a CT model depends on the type of installation:

- insulated cables
- PrismaSeT P Active vertical busbars
- insulated flexible busbars
- Linergy LGY vertical busbars
- rigid busbars.

When installing a CT, we recommend that you comply with the following mounting rules:

- install current transformers:
 - on an easily dismantlable busbars or copper connections
 - between 2 connection points, by joints or bolted connection
 - place the current transformer so that the identification markings remain readable.

For large current transformers, a staggered installation is recommended to prevent arcing on fixing screws or excessive spacing between phase conductors.

If they are installed on vertical busbars, secure the current transformers in place to prevent them from slipping downwards (for example using a bolt or a pin)

- when there are several busbars per phase, fit spacers between the busbars in order to:
 - resist the tightening forces when installing the current transformer
 - avoid vibrations that lead to current transformer breakdowns.



CT on vertical busbars.

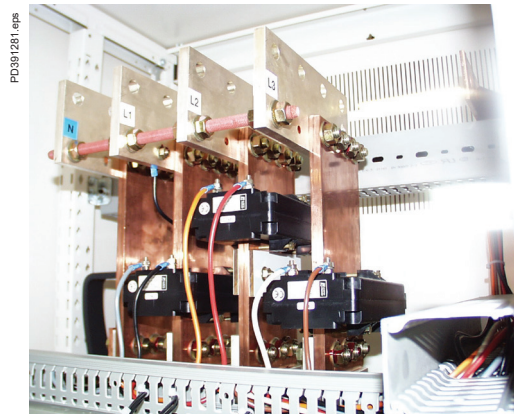

Spacers between the bars.

Practical information

Our circuit breakers have trip units with a **built-in ammeter** (see Micrologic Catalog). Their use eliminates the need for installing a CT on the busbars.

The CT casing is a solution for installation of CTs up to 1600 A. CTs can be installed in the casing (cat. no. LVS03506). It is equipped with a frame made up of 2 uprights, adjustable in depth and 2 slotted cross-members to fix the cables, install CTs or install a busbar support with 75 mm spacing. It is secured in the switchgear compartment of a 400 or 600 mm deep cubicle.

The 300 mm duct allows easier mounting of CTs. To install 2 CTs, downstream from a circuit breaker for example, it is often easier to use a 300 mm wide duct (cat. no. LVS08403 for 400 mm depth or cat. no. LVS08603 for 600 mm depth).

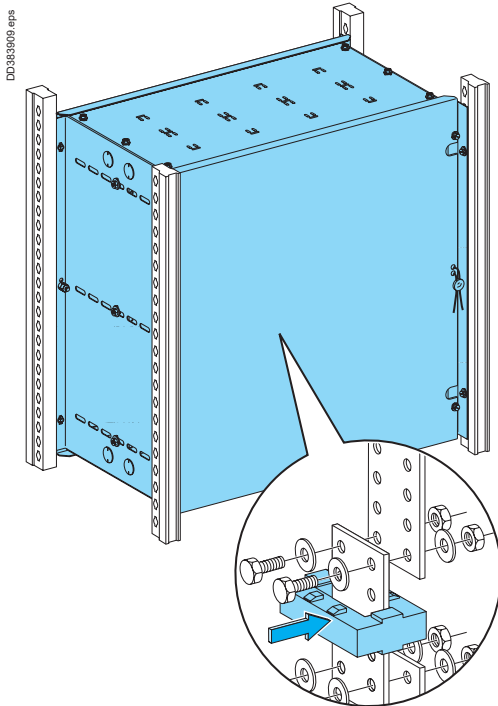

Sealable CT casing with current transformers on bolted connections.

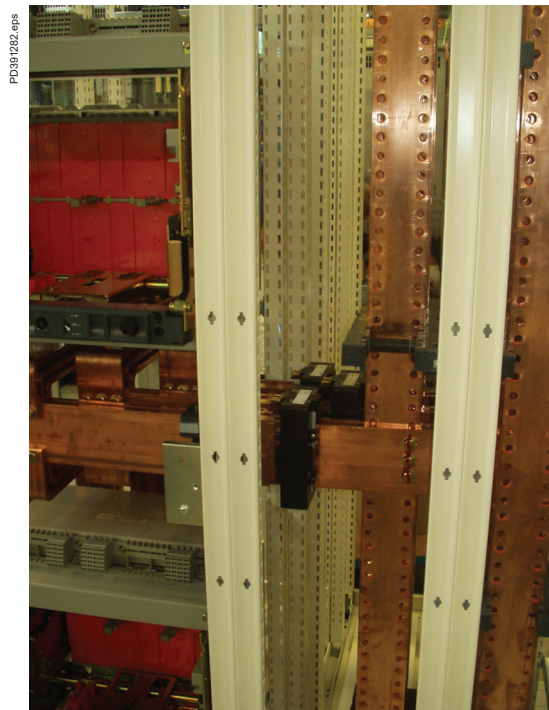

CT on circuit breaker downstream connection busbars.

Installation of source changeover systems

Practical information



Source changeover system in the same cubicle.

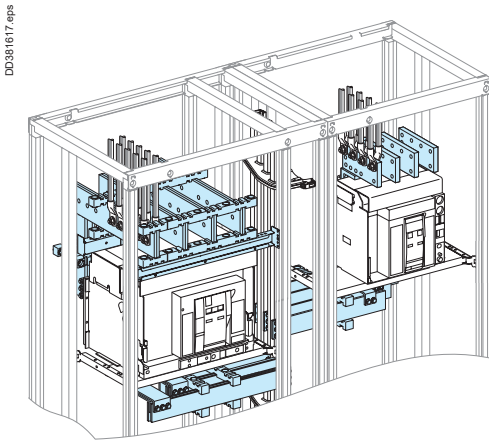

Source changeover system in 2 combined cubicles.



Principle of the PrismaSeT P Active solution

PrismaSeT P Active simplifies the installation of source changeover systems.

The "source changeover" solution is an integral part of the PrismaSeT P Active offering and is designed for all installation cases: 2 or 3 devices side by side or 2 superimposed devices.

The page opposite shows a few examples of installation in cubicles:

- 1 normal source/1 replacement source
- 2 normal sources with coupling (priority and non-priority circuits)
- 2 normal sources + 1 replacement source with coupling (priority and non-priority, circuits).

Note that our configuration software can be used to produce the switchboard front panel drawings.

For each source changeover configuration, various combinations of normal and replacement source circuit breakers and switch-disconnectors are possible:

- 1 normal source/1 replacement source:
 - NS630b to NS1600 / NS630b to NS1600
 - NT / NT
 - NT / NW
 - NW / NT
 - NW / NW
- 2 normal sources with coupling:
 - NW / NW / NW
 - NT / NT / NT
 - NW / NW / NW
- 2 normal sources + 1 replacement source with coupling:
 - NW / NW / NW / NW or NT.

Tables in the Catalog indicate the possible combinations "normal" and "replacement" devices according to the rating as well as the types of interlocking available for the different types of devices.

Highly economical vertical configurations are possible even for the largest devices.

In this case, interlocking may be:

- mechanical by cable + motor mechanism
- via rotary handles (for NS630b/1600 only).

To define the number of modules required to install superimposed devices, all you have to do is add up the number of modules required for each device with:

- its connections
- its cover and its partitioning.

Installation of source changeover systems

Practical information

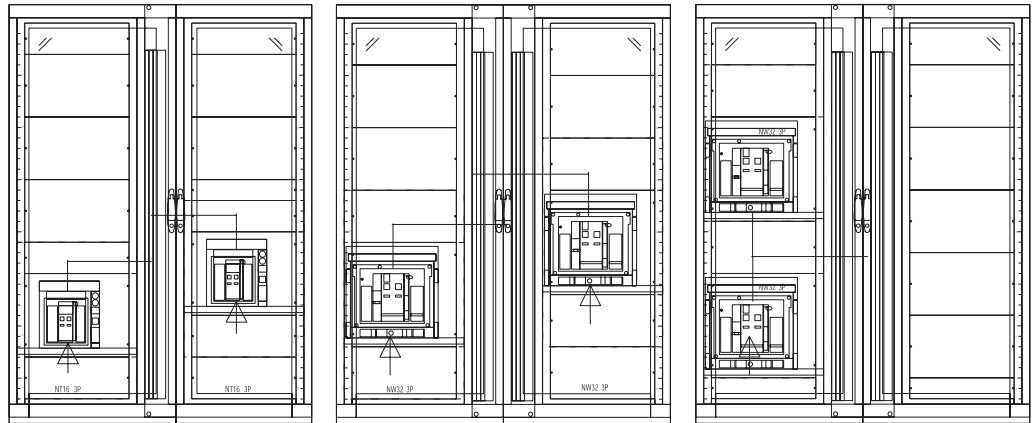
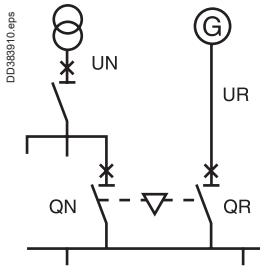

1 normal source
1 replacement source

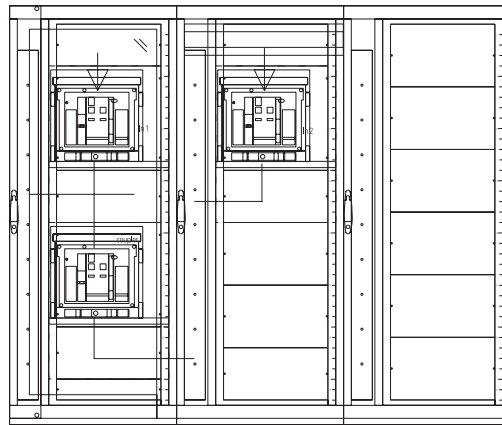
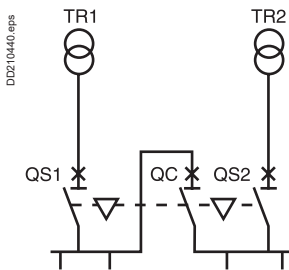

2 normal sources and coupling on busbars

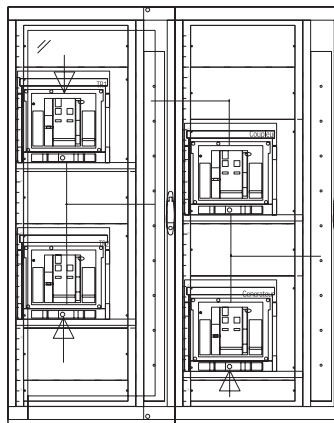
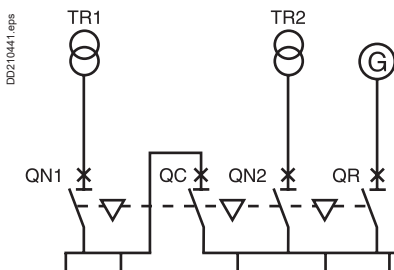

2 normal sources
1 replacement source and coupling on busbars



Storage recommendations

Practical information

Cubicles must be stored in upright position in a dry and ventilated location, sheltered from rain, weather, dripping and running water, dust and chemical agents.

Apart from IP55 cubicles, never store enclosures outdoors, even under an awning or tarp.

The cubicles should if possible be left in their packing until they are installed. In this way they are protected against all risks that may be encountered on the site (impacts, splashes, etc.).

Acceptable storage temperatures are -25 °C to $+55\text{ °C}$ (or up to $+70\text{ °C}$ for short periods not exceeding 24 hours).

Given their heavy weight, cubicles should be stored on a stable, rigid and flat floor to avoid any risk of tipping during storage or handling.

Packing information

Practical information

Receiving the switchboard

On receipt of the equipment and before handling it, check that the cases and packing materials used for transportation have not been damaged and that all items on the packing list have been effectively delivered.

- Even if the packing appears to be in good condition, do not hesitate to unpack the equipment in the presence of an authorised transport agent.
- Check the contents and weights of the shipping units. Thoroughly check the equipment to make sure that no damage or shocks have occurred that could impair insulation or operation.
- If necessary, check that the information on the switchboard nameplate, located on the incoming cubicle, complies with the information indicated on the delivery slip.
- In case of damage or missing parts, inform the transport agent by registered mail.
- After this inspection, refit the plastic protective cover.

PrismaSeT P Active switchboards are generally shipped as separate cubicles or in transport units comprising 2 cubicles side by side. Shipping units may exceptionally comprise 3 cubicles (see precautions given in the "On-site handling" chapter).

Each shipping unit is marked with:

- project number
- weight
- packing unit information (packing unit number and total quantity)
- position of the centre of gravity
- storage and handling instructions.

Standard packing

The cubicles are protected by a plastic cover in a crate.

The following accessories are attached inside the switchboard:

- installation accessories (lifting/fixing cross-members and external fixing lugs)
- preliminary installation accessories: plinth raisers
- horizontal busbar joints (if required)
- additional nuts and bolts and other mounting hardware
- panels to be fitted after on-site connection: canopies, roof panels, gland plates
- a set of drawings
- device user manuals
- a tube of Swiss white varnish.

Large withdrawable or drawout circuit breakers installed at the top of the cubicle (MasterPacT and ComPacT NSX) are generally delivered separately.

Sea packing

The cubicles are protected by a heat-sealed plastic cover containing desiccant bags and are installed in a ventilated wooden or plywood crate.

As a rule sea crates do not weigh more than 5 tons.

Sorting

In order to sort the different types of packing material, specific waste recovery bins are required.

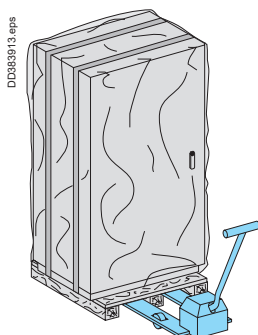
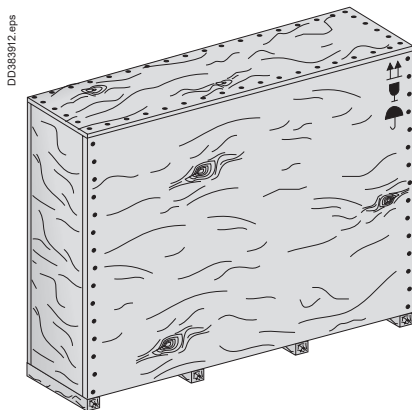
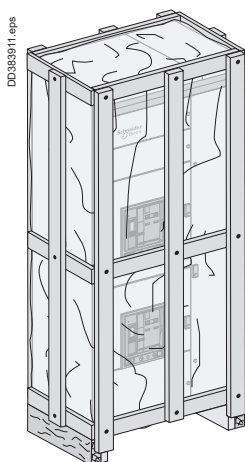

Handling on the site

Practical information

DD38814.eps

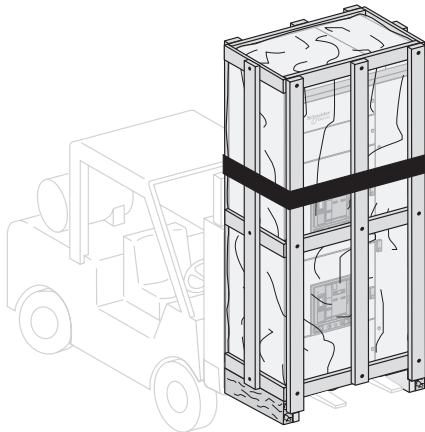

Final unpacking of the equipment will preferably take place just before the switchboard is installed, as close as possible to its final installation location.

As a general guideline, the weight of an average 3200 A cubicle is around 400 kg. Cubicles should always be handled in the **upright position** with care, if possible **by 2 persons**. There is a risk of overturning the cubicle due to the high position of the centre of gravity.

When moving the cubicles, always turn slowly and smoothly, avoiding all bumps and jerks. Enclosures moved using a forklift truck must be lifted carefully and held in position or fastened to the forklift truck using slings during transport.

Handling by the bottom

Wooden beams (or framework stabilizers) are generally attached to the base of the cubicle framework. This allows the cubicles to be moved using a pallet mover or forklift truck.

 The forks must be placed symmetrically with respect to the cubicle's axis so as not to distort the base of the frame.

For cubicles fitted with a plinth, the front and rear base panels must be removed to allow insertion of the pallet mover forks.

Cubicles must be lifted with care and held in place during transport by strapping them onto the handling machine, especially for large distances or bumpy terrain.

For a PrismaSeT P Active switchboard with a busbar compartment, lifting points must be shifted towards the busbars.

Dd81333.eps

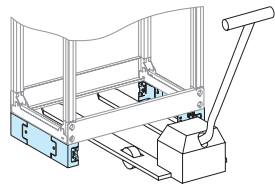

Framework stabiliser.

DD210573.eps

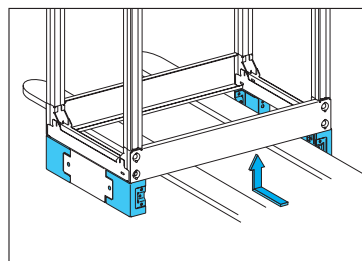
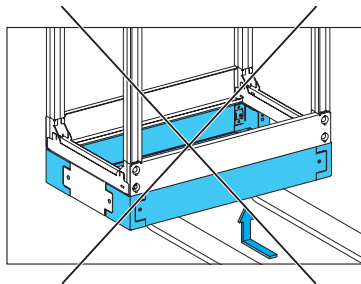

Cubicle with base.

Handling on the site

Practical information

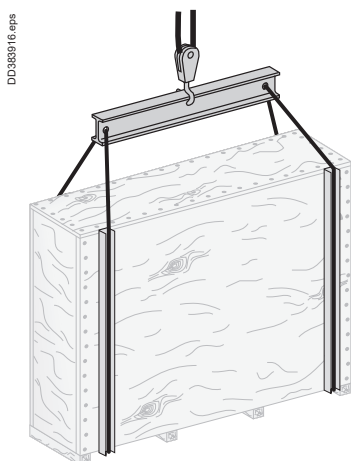
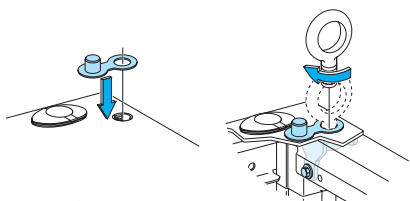
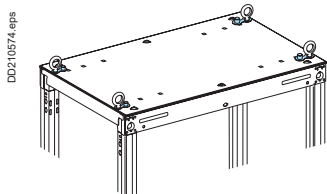
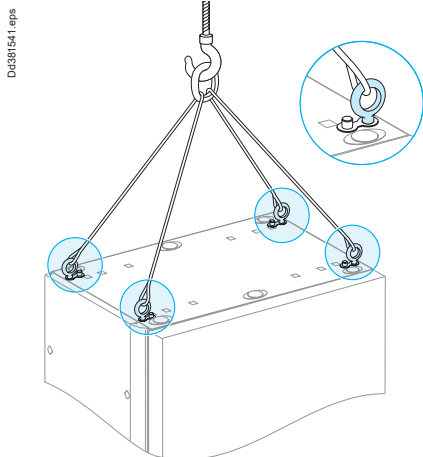

Handling by the top

If cranes or overhead hoists are used, only slings that are sufficiently strong and in good condition should be used.

- The slings must be attached to the 4 cubicle lifting lugs.
- Adjust the length of the slings according to the switchboard dimensions so that the angle formed does not exceed the angle indicated below depending on the switchboard weight. When 2 switchgear cubicles are combined, a lifting beam must be used.
- Never tilt the cubicle during handling.
- Take care to equally distribute the load on the 4 rings.

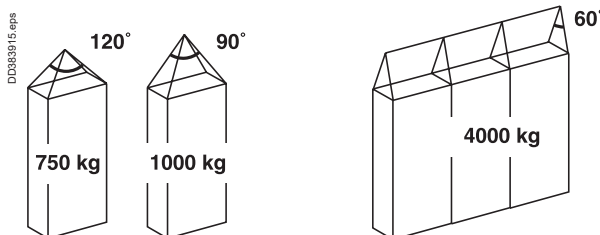

Position of lifting rings

The lifting rings can be installed and removed without dismantling the roof. Even with the lifting rings permanently installed, the switchboard retains its original degree of protection.

For combined cubicles, only install lifting rings on cubicles with switchgear.

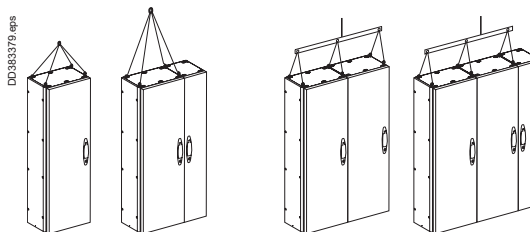

Lifting several cubicles packed together

In the special case of an assembly with more than 2 cubicles, you must:

- first of all move the assembly in its original packing as close as possible to where it is to be installed
- use a lifting beam and slings to support the switchboard from underneath.

Practical information

The cubicles must be loaded vertically (stacking strongly discouraged).
After loading, check that the equipment is firmly secured in the truck to avoid any risk of damage during transport.

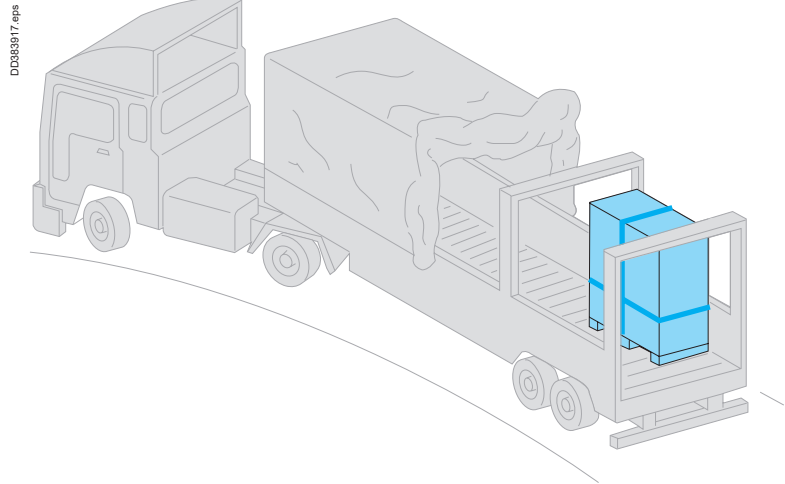

Enclosures supplied as kits should be transported horizontally if possible.

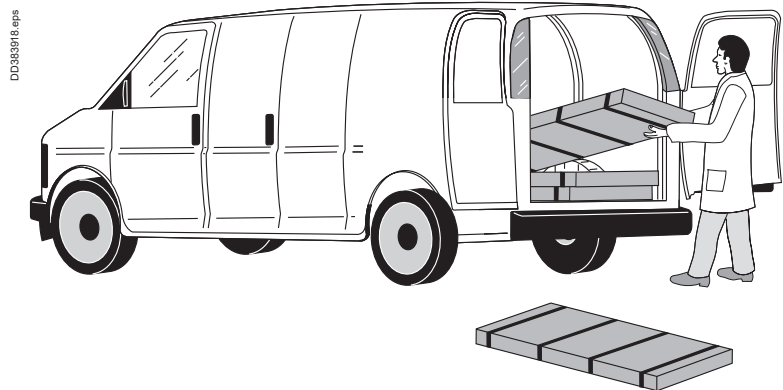

Cubicle handling and rolling base Lifting reinforcement kit for combined cubicles

Practical information

50 mm high base

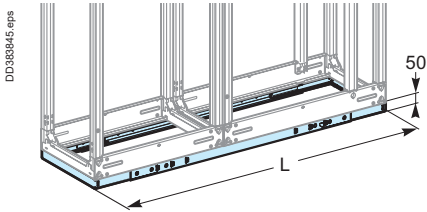

LVS08714

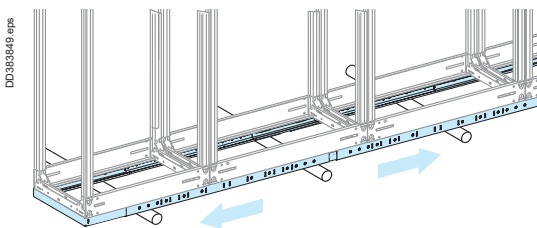

Combined cubicles equipped with a handling base can be moved easily and safely on rollers.

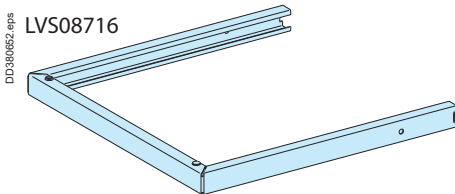

LVS08716

This type of base is designed to increase the rigidity of cubicle frameworks to avoid any risk of deformation during transport and handling. Five different Catalog numbers offer 27 width possibilities (1200 to 3050 mm) for 400 and 600 mm deep cubicles.

- Two Catalog numbers each include 2 end-pieces for handling bases for 400 and 600 mm deep cubicles respectively and the corresponding mounting hardware.
- Three Catalog numbers each include 2 lengths for the sides of handling bases for 1200 to 3050 mm wide cubicles respectively and the corresponding mounting hardware.

Handling bases can be used for both side-by-side and back-to-back cubicle combinations.

In this case, the mounting hardware for one of the sets is used.

Designation		Cat. no.
2 cubicle handling base end-pieces	D = 400 mm	LVS08714
	D = 600 mm	LVS08716
2 cubicle handling base side-lengths	W = 2000 to 2550 mm	LVS08706

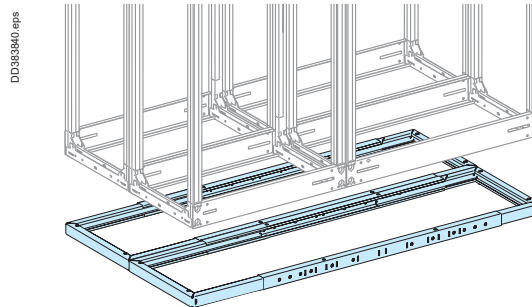

Side-by-side and back-to-back combination of 4 cubicles equipped with a handling base.

Lifting reinforcement kit

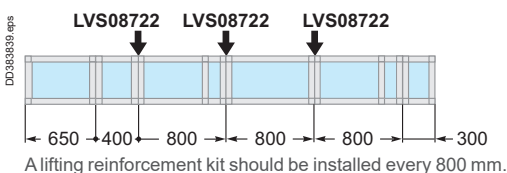
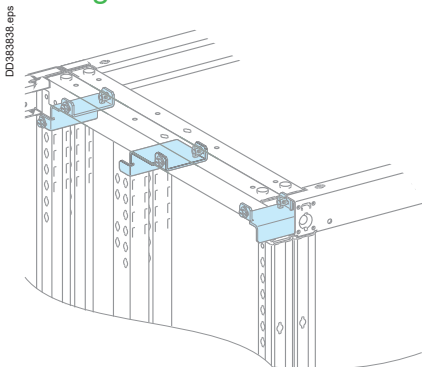

- Kit LVS08722 is recommended for lifting combined cubicles and can be used together with handling base end-pieces LVS08714 for severe transport or handling conditions.
- Catalog number LVS08722 includes 3 reinforcement brackets for 400 or 600 mm deep cubicles and the corresponding mounting hardware.

Designation		Cat. no.
Lifting reinforcement kit for combined cubicles	W = 400/600 mm	LVS08722



Connection of busbar trunking

Practical information

PrismaSeT P switchboards come equipped with a special interface that allows them to be directly connected to Canalis KT trunking.

The electrical connection between the Canalis KT trunking and the PrismaSeT P switchboard is just as easy to carry out as jointing between two busbar trunking sections.

The Canalis KT interface is totally integrated in the PrismaSeT P switchboard volume.

It comprises a Canalis KT joint block and interface/circuit breaker connection terminals.

Trunking connection via the top

- Dismantle the roof.
- Cut out a passage for the busbar trunking.
- Adjust the guides according to the KT width that will be connected.
- Unscrew the junction block screws.
- Ensure that the busbar trunking length to be connected to the switchboard is correctly supported and that it is not resting on the interface.
- Lower the element until it is in contact with the interface frame, without bearing on it.
- Tighten the junction torque nuts. When the head breaks, the torque of 60 Nm has been reached.

 In certain cases, it is recommended to only tighten the 2 middle nuts to 60 Nm and the 2 outer nuts to 10 Nm.

- A red plastic washer that is ejected when the head breaks provides visual evidence that the joint tightening operation has been carried out correctly.
- For dismantling or maintenance operations, a second head is available on the nut and can be retightened using a conventional torque wrench. The recommended tightening torque is then 60 Nm.
- Reassemble the roof.

Sealing kit

- In order to retain the original IP index, use the roof sealing kit ordered with the busbar trunking. This kit guarantees an IP52 degree of protection at the trunking passage.
- The kit is installed by cutting out the roof of the PrismaSeT P switchboard. This cut-out, which is the same dimension for all Canalis KT busbar trunking ratings, is made using the template delivered with the sealing kit.

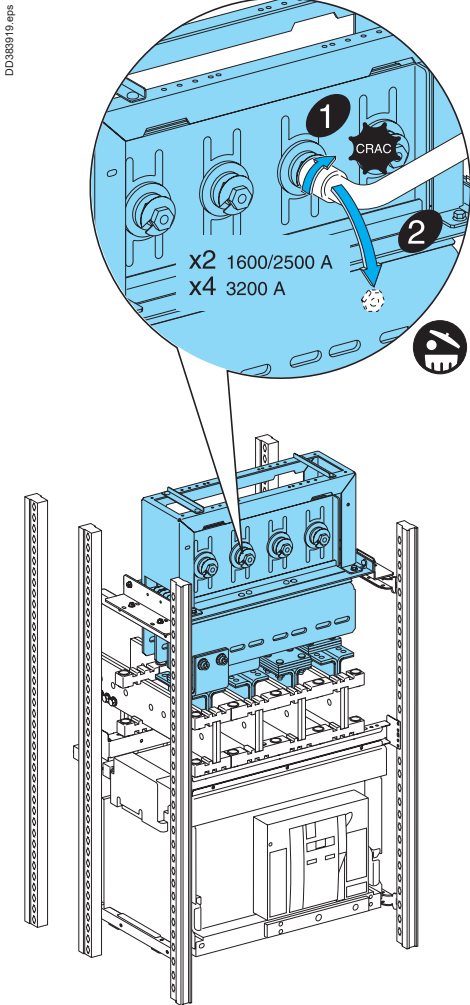

Connection of power cables

Practical information

To ensure protection of persons, first connect the switchboard protective conductor to the earth electrode.

- Tie the cables as close as possible to the connections to avoid any mechanical stresses on the device terminals. When not using cable glands, also attach the cables near to the cubicle entry point.
- Cables must never be in contact with or passed between live conductors.
- Sharp edges of the framework must be protected where cables pass to avoid damaging the conductors.
- Comply with a minimum radius of curvature of 6 to 8 times the cable outside diameter.
- All power connections must be made with class 8.8 mounting hardware and elastic contact washers, tightened to the torque indicated in the table below.
- When connecting aluminium cables to copper terminals, use bimetal lugs or interfaces.
- Separate the different types of circuits into separate cable bundles (power, control, 48 V, 24 V, DC, AC, etc).

Cable bundles

Cable cross-sectional area (mm ²)	Max. number of cables per bundle
CSA ≤ 10	8
16 < CSA ≤ 50	4
CSA ≥ 50	Tie individually

Tying the cable bundles

Type of tie	Maximum I _{cw} (kA/rms 1s)	Distance between ties (mm)
Width: 4.5 mm Load: 22 kg	10	200
	15	100
	20	50
Width: 9 mm Load: 80 kg	20	350
	25	200
	35	100
	45	70

For cable sizes of 50 mm² or more, use 9 mm wide fixing ties.

Recommended tightening torque for mechanical and electrical connections with 8.8 class screws.

Diameter of screw	Tightening torque (Nm) (with nut + contact washer)
M3	1.5
M4	3.5
M5	7
M6	13
M8	28
M10	50
M12	75

Connection of power cables

Practical information

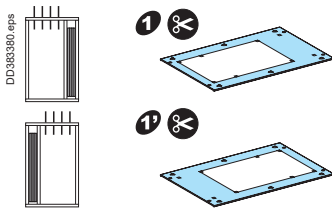

Connection via the top

- Remove the roof.
 - Drill the holes required to install cable glands or grommets.
 - Install the cable glands or grommets. They must comply with the switchboard's degree of protection (IP).
 - Refit the roof.
 - Run the cables through the glands or grommets.
 - Run the cables in the intended compartments and secure them to cable tie-bars every 400 mm.
 - Crimp the lugs and connect.
 - When sealing does not call for cable glands or when sealing is achieved by means of foam, cables can be routed in a rectangular cut-out in the roof.
- The removable cross-member simplifies insertion of cables in the cubicle.

Connection via the bottom

Using a 2-part gland plate

- Drilling is not necessary with this type of gland plate.
- The gland plate avoids producing an induced current.
- The cables are protected by a polyurethane foam seal which provides a sealing function.

Using a 1-part gland plate

- Remove the bottom plate.
- Drill the appropriate holes to assemble the cable glands or grommets (1-part gland plates should not be drilled within 30 mm of the edges).
- Install the cable glands or grommets. They must comply with the required degree of protection (IP).
- Refit the bottom plate.
- Run the cables through the glands or grommets.
- Run the cables in the intended compartments and secure them to cable tie-bars every 400 mm.
- If cable glands are not used, it may be easier to prepare the cable terminations outside the switchboard (e.g. lug crimping) and then to drop them inside the cubicle having first disassembled the bottom removable cross-member.

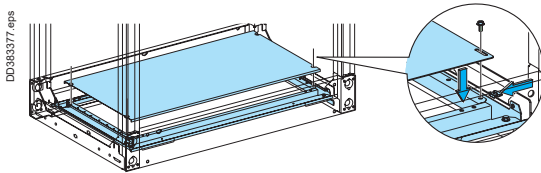
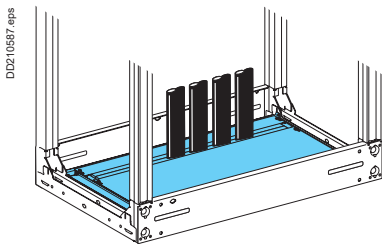

Covering an incomer

For MasterPact MT22 / MTZ1 / NS1600b-3200 / ComPacT NS630b-1600

- Disassemble the cover plate to access to the device connection terminals.
- Connect the cables, respecting the required electrical clearances.
- Cut out the part of the cover disassembled in order to let the cables pass through it, while preserving the necessary degree of protection.

Connection of power cables

Practical information

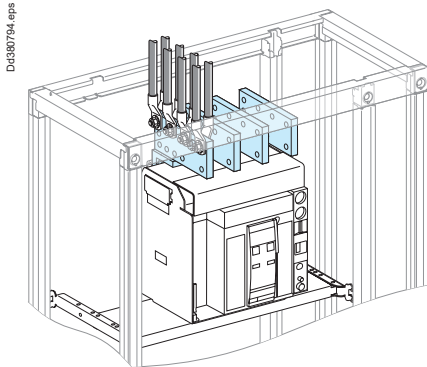

Removable upper cross-member.

Connecting to terminal extension bars

- Check that the circuit and switchgear identification indications match.
- When connections are made to terminal extensions made up of several bars for each phase, position the lugs opposite one another and insert copper spacers between the bars.
- Comply with the minimum required electrical clearances between phases of 14 mm (conforming with IEC 60439-1).
- Mark all nuts and the terminal extension bars with a dot of varnish after tightening to the defined torque.
- Remove the top cross-member of the cubicle to simplify connection of the cables to the bars.
- Tie cables of the same phase together.

Connection directly to device terminals

- When connections are made directly to the switchgear terminals, comply with the tightening torque recommended by the device manufacturer.
- Check that the length of the screws delivered with the switchgear is compatible with the lug thickness.
- Comply with the safety clearances around the switchgear devices, defined by the manufacturer to ensure correct operation.
- Refit the interphase barriers and terminal shields if applicable after connection the power cables.
- For the special case of connection with armoured cable, please consult us.

Preventive maintenance

Maintenance

Frequency

- The frequency of preventive maintenance depends primarily on the operating conditions of the electrical switchboard.
- For operating conditions found in normal environments, the frequency should be as indicated in the recommended calendar.
- It may be extended if the switchboard is used in a particularly clean environment and not in an intensive manner.
- It must be reduced if the switchboard is used in a particularly aggressive environment (dust, humidity, corrosive vapours, heat) or is used intensively.
- Recommended calendar

Type	Action	Frequency
General inspection	Visual checks and general cleaning. Visual check of busbars. Running tests	Once a year
Maintenance on functional units	Inspection of the connections	Every 5 years
Maintenance of ventilation system	Cleaning of filters	Every 6 months
Maintenance of devices	According to the respective handbooks	

General recommendations

Before any intervention on the connections, switch off the functional unit, remove the protective screens and the partitioning sheets and boxes.

- For interventions on the connections, refer to chapter "Connections", profession Install.
- When reassembling the connections:
 - use new screws, washers, nuts of the same type (class 8.8)
 - tighten to the defined torque (refer to the tightening torques table in the chapter "Connection/Tools required")
 - apply varnish.

Method of inspection of the electrical connections

- Connections by lugs or screwed bars: presence of varnish, colour changes of a copper bar.
- Connections by cage type terminals: if necessary, re-screw to the torque defined by the manufacturer to compensate for a possible creep.

Please ensure that you consult the "General" chapter section dealing with safety instructions.

Preventive maintenance

Maintenance

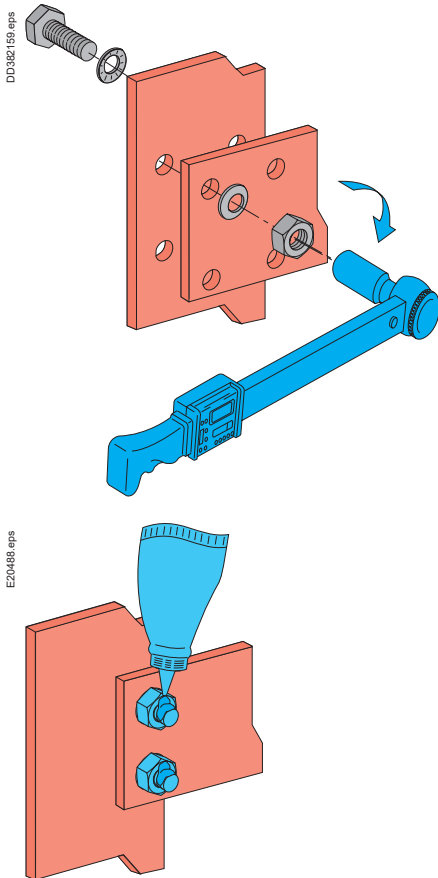

General inspection

Visual checks and general cleaning of the cubicles

- Check the lack of humidity and foreign bodies inside and outside the switchboard.
- Examine the outer finish. If necessary, touch up any paint scratches and replace any damaged or rusted parts.
- Clean the switchboard, preferably with a vacuum cleaner.
- If necessary, clean the ventilation system and change the filters.

Visual check of busbars

- Connections do not need to be tightened as they were already tightened to the tightening torque in workshop and the use of a contact washer compensates for possible creeps due to overheating. The presence of vernish guaranteeing correct tightening torque, is intact.
- The control of busbars connections and outgoing cables connections can be carried when disassembling the protection (out of supply) or if a hot point is detected (infrared control or thermal sensors). A hot point materialises by a change in the copper colour.
- In case of hot point see "Corrective maintenance".
- Check the condition of insulating busbars supports.

Cleaning of panel ventilation filters

Standard or fine filters

- Wash with water (preferably using a high-quality detergent).
- It is also possible to remove the dust by tapping, vacuuming or blowing with compressed air.
- If there is any oil or grease, change the filter.

Corrective maintenance

Maintenance

General

General recommendations

- Before any intervention on the connections, switch off the cubicle, remove the protective screens and the partitioning sheets and boxes.
- When reassembling the connections:
 - use new screws, washers, nuts of the same type (class 8.8)
 - tighten to the defined torque (refer to the tightening torque table in chapter "Connection/Connection of power cables")
 - apply varnish.

Hot point

Screwed connection

- Identify the cause: generally a loosening connection.
- Dismantle the assembly.
- Clean and rub down surfaces in contact (e.g. sandpaper N° 400).
- Set the connection up.

Maintenance after a fault has occurred

The high currents resulting from a fault cause damage to structures, components, busbars and cables.

Following a fault, contact your local Schneider Electric office.

Troubleshooting and interventions

For any interventions other than those described in this manual, **contact your local Schneider Electric agency.**

Life Is On



Schneider Electric Industries SAS

35, rue Joseph Monier
CS 30323
92506 Rueil Malmaison Cedex
France

RCS Nanterre 954 503 439
Capital social 896 313 776 €
www.se.com

12-2023
DESW026EN

© 2023 - Schneider Electric. All Rights Reserved.
All trademarks are owned by Schneider Electric Industries SAS or its affiliated companies.
Document reference: DESW026EN

This document has been
printed on recycled paper

