

Contactors – TeSys D – TeSys D Green			
Type of product	Range		Pages
AC-3 applications - 3-pole, 4-pole contactors	From 9 to 150 A		B8/2
AC-1 applications - 3-pole, 4-pole contactors	From 25 to 200 A		B8/3
UL CSA standards - 3-pole contactors	From 25 to 200 A		B8/8
AC/DC compatible coil contactors - TeSys D Green AC-3, AC-1, UL CSA	From 9 to 80 A		B8/9
Reversing, changeover pre-assembled contactors	From 9 to 150 A		B8/16
AC/DC compatible coil, reversing contactors - TeSys D Green	From 9 to 80 A		B8/18
Contactors for capacitor banks switching	From 12.5 to 60 kVAR		B8/21
Auxiliary contact blocks – accessories – spare coils for TeSys D, TeSys D Green			B8/23
Mini contactors – TeSys SK, K			
Mini contactors TeSys SK	Up to 6 A		B8/38
Mini contactors TeSys K	From 6 to 16 A		B8/40
Reversing pre-assembled mini contactors TeSys K	From 6 to 16 A		B8/44
Auxiliary contact blocks - accessories			B8/49
Contactors for use in modular enclosures / Din rail			
Mini contactors TeSys SKGC	Up to 20 A		B8/52
Modular contactors TeSys GC	From 16 to 100 A		B8/54
Dual tariff contactors TeSys GY	16, 25, 40 or 100 A		B8/55
Impulse relay TeSys GF	Up to 16 A		B8/56
Auxiliary contact blocks - accessories TeSys GC, GY			B8/57

TeSys contactors

TeSys D contactors for motor control up to 75 kW at 400 V, in category AC-3

For connection by screw clamp terminals and lugs



LC1 D09●●



LC1 D25●●



LC1 D80A●●

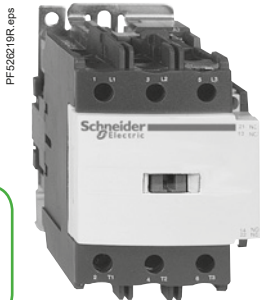

LC1 D95●●



LC1 D115●●

3-pole contactors

Standard power ratings of 3-phase motors 50-60 Hz in category AC-3 ($\theta \leq 60^\circ\text{C}$)								Rated operational current in AC-3 440 V up to	Instan- taneous auxiliary contacts	Basic reference, to be completed by adding the control voltage code ⁽²⁾	Weight ⁽³⁾
220 V	380 V	415 V	440 V	500 V	660 V	1000 V					
230 V	400 V				690 V						
kW	kW	kW	kW	kW	kW	kW	A				kg
Connection by screw clamp terminals											
2.2	4	4	4	5.5	5.5	-	9	1	1	LC1D09●●	0.320
3	5.5	5.5	5.5	7.5	7.5	-	12	1	1	LC1D12●●	0.325
4	7.5	9	9	10	10	-	18	1	1	LC1D18●●	0.330
5.5	11	11	11	15	15	-	25	1	1	LC1D25●●	0.370
7.5	15	15	15	18.5	18.5	-	32	1	1	LC1D32●●	0.375
9	18.5	18.5	18.5	18.5	18.5	-	38	1	1	LC1D38●●	0.380
Power connections by EverLink® BTR screw connectors ⁽⁴⁾ and control by screw clamp terminal											
11	18.5	22	22	22	30	-	40	1	1	LC1D40A●●	0.850
15	22	25	30	30	33	-	50	1	1	LC1D50A●●	0.855
18.5	30	37	37	37	37	-	65	1	1	LC1D65A●●	0.860
22	37	37	37	37	37	-	66	1	1	LC1D80A●●	0.860
Connection by screw clamp terminals or connectors											
22	37	45	45	55	45	45	80	1	1	LC1D80●●	1.590
25	45	45	45	55	45	45	95	1	1	LC1D95●●	1.610
30	55	59	59	75	80	65	115	1	1	LC1D115●●	2.500
40	75	80	80	90	100	75	150	1	1	LC1D150●●	2.500

Connection by lugs or bars

In the references selected above, insert a figure 6 before the voltage code.
Example: LC1 D09●● becomes LC1 D096●●.

Separate components

Auxiliary contact blocks and add-on modules: see pages B8/23 to B8/29.

- (1) LC1 D09 to D80A: clip-on mounting on 35 mm rail AM1 DP or screw fixing.
LC1 D80 to D95: clip-on mounting on 35 mm rail AM1 DP or 75 mm rail AM1 DL or screw fixing.
LC1 D80 to D95: clip-on mounting on 75 mm rail AM1 DL or screw fixing.
LC1 D115 and D150: clip-on mounting on 2 x 35 mm rails AM1 DP or screw fixing.
- (2) Standard control circuit voltages (for other voltages, please consult your Regional Sales Office):

a.c. supply

Volts	24	42	48	110	115	220	230	240	380	400	415	440	500
LC1 D09...D150 (D115 and D150 coils with built-in suppression as standard, by bi-directional peak limiting diode).													
50/60 Hz	B7	D7	E7	F7	FE7	M7	P7	U7	Q7	V7	N7	R7	S7
LC1 D09...D65 (not available with "connection for lugs or bars")													
50 Hz	B5	D5	E5				P5						
LC1 D80...D115													
50 Hz	B5	D5	E5	F5	FE5	M5	P5	U5	Q5	V5	N5	R5	S5
60 Hz	B6	-	E6	F6	-	M6	-	U6	Q6	-	-	R6	-

d.c. supply

Volts	12	24	36	48	60	72	110	125	220	250	440
LC1 D09...D38 (coils with integral suppression device fitted as standard, by bi-directional peak limiting diode)											
U 0.7...1.25 Uc	JD	BD	CD	ED	ND	SD	FD	GD	MD	UD	RD
LC1 D40A ...D65A (coils with integral suppression device fitted as standard, by bi-directional peak limiting diode)											
U 0.75...1.25 Uc	JD	BD	CD	ED	ND	SD	FD	GD	MD	UD	RD
LC1 D80...D95											
U 0.85...1.1 Uc	JD	BD	CD	ED	ND	SD	FD	GD	MD	UD	RD
U 0.75...1.2 Uc	JW	BW	CW	EW	-	SW	FW	-	MW	-	-
LC1 D115 and D150 (coil with built-in suppression device as standard)											
U 0.75...1.2 Uc	-	BD	-	ED	ND	SD	FD	GD	MD	UD	RD

Low consumption

Volts	5	12	20	24	48	110	220	250
LC1 D09...D38 (coils with integral suppression device fitted as standard, by bi-directional peak limiting diode)								
U 0.8...1.25 Uc	AL	JL	ZL	BL	EL	FL	ML	UL

a.c. / d.c. supply - low consumption

See TeSys D Green, page B8/13

For other voltages between 5 and 690 V, see pages B8/32 to B8/35.

(3) The weights indicated are for contactors with a.c. control circuit. For d.c. or low consumption control circuit, add 0.160 kg from LC1 D09 to D38, 0.075 kg from LC1 D40A to D80A and 1 kg for LC1 D80 and D95.

(4) BTR screws: hexagon socket head. In accordance with local electrical wiring regulations, a size 4 insulated Allen key must be used (reference LAD ALLEN4, see page B8/29).

TeSys contactors

TeSys D contactors for motor control up to 30 kW at 400 V, in category AC-3

For connection by spring terminals

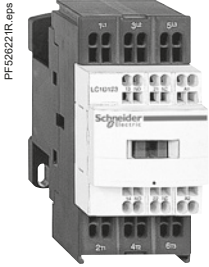

LC1 D123●●



LCD 80A3●●

3-pole contactors

Standard power ratings of 3-phase motors 50-60 Hz in category AC-3 ($\theta \leq 60^\circ\text{C}$)	Rated operational current in AC-3 440 V up to	Instan- taneous auxiliary contacts	Basic reference, to be completed by adding the control voltage code ⁽²⁾
220 V 380 V 415 V 440 V 500 V 660 V 1000 V 230 V 400 V			Fixing ⁽¹⁾

Power and control connections by spring terminals

kW	kW	kW	kW	kW	kW	kW	A			
2.2	4	4	4	5.5	5.5		9	1	1	LC1D093●●
3	5.5	5.5	5.5	7.5	7.5		12	1	1	LC1D123●●
4	7.5	9	9	10	10		18	1	1	LC1D183●●
5.5	11	11	11	15	15		25	1	1	LC1D253●●
7.5	15	15	15	18.5	18.5		32 ⁽⁴⁾	1	1	LC1D323●●

Power connections by EverLink® BTR screw connectors ⁽⁵⁾ and control by spring terminals

11	18.5	22	22	22	30	30	40	1	1	LC1D40A3●●
15	22	25	30	30	33		50	1	1	LC1D50A3●●
18.5	30	37	37	37	37		65	1	1	LC1D65A3●●
22	37	37	37	37	37		66	1	1	LC1D80A3●●

Connection by Faston connectors

These contactors are fitted with Faston connectors: 2 x 6.35 mm on the power poles and 1 x 6.35 mm on the coil and auxiliary terminals.

For contactors LC1 D09 and LC1 D12 only, replace the figure 3 with a 9 in the references selected above.

Example: LC1 D093●● becomes LC1 D099●●.

Separate components

Auxiliary contact blocks and add-on modules: see pages B8/23 to B8/29.

⁽¹⁾ LC1 D09 to D32: clip-on mounting on 35 mm rail AM1 DP or screw fixing.

⁽²⁾ Standard control circuit voltages (for other voltages, please consult your Regional Sales Office):

a.c. supply													
Volts	24	42	48	110	115	220	230	240	380	400	415	440	
LC1 D09...D80A													
50/60 Hz		B7	D7	E7	F7	FE7	M7	P7	U7	Q7	V7	N7	R7
d.c. supply													
Volts	12	24	36	48	60	72	110	125	220	250	440		
LC1 D09...D32 (coils with integral suppression device fitted as standard, by bi-directional peak limiting diode)													
U 0.7...1.25 Uc		JD	BD	CD	ED	ND	SD	FD	GD	MD	UD	RD	
LC1 D40A...D65A (coils with integral suppression device fitted as standard, by bi-directional peak limiting diode)													
U 0.75...1.25 Uc		JD	BD	CD	ED	ND	SD	FD	GD	MD	UD	RD	
Low consumption													
Volts	5	12	20	24	48	110	220	250					
LC1 D09...D32 (coils with integral suppression device fitted as standard, by bi-directional peak limiting diode)													
U 0.8...1.25 Uc		AL	JL	ZL	BL	EL	FL	ML	UL				

For other voltages between 5 and 690 V, see pages B8/32 to B8/35.

⁽³⁾ The weights indicated are for contactors with a.c. control circuit.

For d.c. or low consumption control circuit, add 0.160 kg from LC1 D09 to D32 and 0.075 kg from LC1 D40A to D80A.

⁽⁴⁾ Must be wired with 2 x 4 mm² cables in parallel on the upstream side. On the downstream side, outgoing terminal block LAD 331 may be used (Quickfit technology, see page B1/18). When wired with a single cable, the product is limited to 25 A (11 kW/400 V motors).

⁽⁵⁾ BTR screws: hexagon socket head. In accordance with local electrical wiring regulations, a size 4 insulated Allen key must be used (reference LAD ALLEN4, see page B8/29).

TeSys contactors

TeSys D, 3-pole contactors

For control in category AC-1, from 25 to 200 A



LC1 D09●●



LC1 D80A●●

3-pole contactors					
Non inductive loads maximum current ($\theta \leq 60^\circ\text{C}$) utilisation category AC-1	Number of poles	Instantaneous auxiliary contacts		Basic reference, to be completed by adding the control voltage code ⁽¹⁾	Weight ⁽³⁾
				Fixing ⁽²⁾	
A					kg
Connection by screw clamp terminals					
25	3	1	1	LC1D09●●	0.320
				or LC1D12●●	0.325
32	3	1	1	LC1D18●●	0.330
40	3	1	1	LC1D25●●	0.370
50	3	1	1	LC1D32●●	0.375
				or LC1D38●●	0.380
Connection by EverLink®, BTR screw connectors ⁽⁴⁾					
60	3	1	1	LC1D40A●●	0.850
80	3	1	1	LC1D50A●●	0.855
				or LC1D65A●● ⁽⁵⁾	0.860
				or LC1D80A●● ⁽⁵⁾	0.860
Connection by screw clamp terminals or connectors					
125	3	1	1	LC1D80●●	1.590
				or LC1D95●● ⁽⁵⁾	1.610
200	3	1	1	LC1D115●●	2.500
				or LC1D150●● ⁽⁶⁾	2.500

3-pole contactors for connection by lugs

In the references selected above, insert a figure 6 before the voltage code.

Example: LC1 D09●● becomes LC1 D096●●.

⁽¹⁾ Standard control circuit voltages (for other voltages, please consult your Regional Sales Office):

a.c. supply													
Volts	24	42	48	110	115	220	230	240	380	400	415	440	500
LC1 D09...D150 (LC1D115 and D150 coils with built-in suppression device as standard)													
50/60 Hz	B7	D7	E7	F7	FE7	M7	P7	U7	Q7	V7	N7	R7	S7
LC1 D09...D65 (not available with "connection for lugs or bars")													
50 Hz	B5	D5	E5	P5									
LC1 D80...D150													
50 Hz	B5	D5	E5	F5	FE5	M5	P5	U5	Q5	V5	N5	R5	S5
60 Hz	B6	-	E6	F6	-	M6	-	U6	Q6	-	-	R6	-
d.c. supply													
Volts	12	24	36	48	60	72	110	125	220	250	440		
LC1 D09...D38 (coils with integral suppression device fitted as standard, by bi-directional peak limiting diode)													
U 0.7...1.25 Uc	JD	BD	CD	ED	ND	SD	FD	GD	MD	UD	RD		
LC1 D40A ...D65A (coils with integral suppression device fitted as standard, by bi-directional peak limiting diode)													
U 0.75...1.25 Uc	JD	BD	CD	ED	ND	SD	FD	GD	MD	UD	RD		
LC1 or LP1 D80 and D95													
U 0.85...1.1 Uc	JD	BD	CD	ED	ND	SD	FD	GD	MD	UD	RD		
U 0.75...1.2 Uc	JW	BW	CW	EW	-	SW	FW	-	MW	-	-		
LC1 D115 and D150 (coils with built-in suppression device fitted as standard)													
U 0.75...1.2 Uc	-	BD	-	ED	ND	SD	FD	GD	MD	UD	RD		
Low consumption													
Volts	5	12	20	24	48	110	220	250					
LC1 D09...D38 (coils with integral suppression device fitted as standard, by bi-directional peak limiting diode)													
U 0.8...1.25 Uc	AL	JL	ZL	BL	EL	FL	ML	UL					

For other voltages between 5 and 690 V, see pages B8/32 to B8/35.

⁽²⁾ LC1 D09 to D80A: clip-on mounting on 35 mm rail AM1 DP or screw fixing.

LC1 D80 and D95: clip-on mounting on 35 mm rail AM1 DP or 75 mm rail AM1 DL or screw fixing.

LC1 or LP1 D80 to D95: clip-on mounting on 75 mm rail AM1 DL or screw fixing.

LC1 D115 and D150: clip-on mounting on 2 x 35 mm rails AM1 DP or screw fixing.

⁽³⁾ The weights indicated are for contactors with a.c. control circuit. For d.c. or low consumption control circuit, add 0.160 kg from LC1 D09 to D38, 0.075 kg from LC1 D40A to D80A and 1 kg for LC1 D80 and D95.

⁽⁴⁾ BTR screws: hexagon socket head. In accordance with local electrical wiring regulations, a size 4 insulated Allen key must be used (reference LAD ALLEN4, see page B8/29).

⁽⁵⁾ Selection according to the number of operating cycles, see AC-1 curve, page A6/30.

⁽⁶⁾ 32 A with 2 x 4 mm² cables connected in parallel.

References - TeSys D

TeSys contactors

TeSys D, 3-pole contactors

For control in category AC-1, from 16 to 80 A

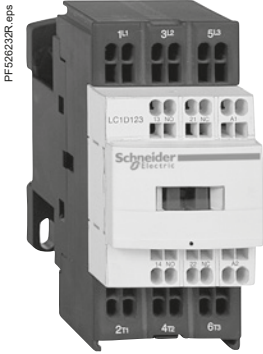

LC1 D123●●



LC1 D80A3●●

3-pole contactors for connection by Faston connectors

These contactors are fitted with Faston connectors: 2 x 6.35 mm on the power poles and 1 x 6.35 mm on the coil terminals. For contactors LC1 D09 and LC1 D12 only, in the references selected from the previous page, insert a figure 9 before the voltage code. Example: **LC1 D09●●** becomes **LC1 D099●●**.

3-pole contactors

Non inductive loads maximum current ($\theta \leq 60^\circ\text{C}$) utilisation category AC-1	Number of poles	Instantaneous auxiliary contacts	Basic reference, to be completed by adding the control voltage code ⁽¹⁾	Weight ⁽³⁾
			Fixing ⁽²⁾	
A				kg

Connection by spring terminals

16	3	1	1	LC1D093●● ⁽⁴⁾	0.320
				or LC1D123●● ⁽⁴⁾	0.325
25	3	1	1	LC1D183●● ⁽⁵⁾	0.335
				or LC1D253●● ⁽⁶⁾	0.325
				or LC1D323●● ⁽⁶⁾	0.325

Power connections by EverLink® BTR screw connectors ⁽⁷⁾ and control by spring terminals

60	3	1	1	LC1D40A3●●	0.850
80	3	1	1	LC1D50A3●● ⁽⁸⁾	0.855
				or LC1D65A3●● ⁽⁸⁾	0.860
				or LC1D80A3●● ⁽⁸⁾	0.860

Separate components

Auxiliary contact blocks and add-on modules: see pages B8/23 to B8/29.

⁽¹⁾ Standard control circuit voltages (for other voltages, please consult your Regional Sales Office):

a.c. supply

Volts	24	42	48	110	115	220	230	240	380	400	415	440	500
LC1 D09...D80A													
50/60 Hz	B7	D7	E7	F7	FE7	M7	P7	U7	Q7	V7	N7	R7	S7

d.c. supply

Volts	12	24	36	48	60	72	110	125	220	250	440
LC1 D09...D32 (coils with integral suppression device fitted as standard, by bi-directional peak limiting diode)											
U 0.7...1.25 U _c	JD	BD	CD	ED	ND	SD	FD	GD	MD	UD	RD

LC1 D40A...D65A (coils with integral suppression device fitted as standard, by bi-directional peak limiting diode)

U 0.75...1.25 U _c	JD	BD	CD	ED	ND	SD	FD	GD	MD	UD	RD
------------------------------	----	----	----	----	----	----	----	----	----	----	----

Low consumption

Volts	5	12	20	24	48	110	220	250
LC1 D09...D32 (coils with integral suppression device fitted as standard, by bi-directional peak limiting diode)								
U 0.8...1.25 U _c	AL	JL	ZL	BL	EL	FL	ML	UL

For other voltages between 5 and 690 V, see pages B8/32 to B8/35.

⁽²⁾ **LC1 D09 to D80A:** clip-on mounting on 35 mm rail **AM1 DP** or screw fixing.

⁽³⁾ The weights indicated are for contactors with a.c. control circuit. For d.c. or low consumption control circuit, add 0.160 kg from **LC1 D09 to D32** and 0.075 kg from **LC1 D40A to D80A**.

⁽⁴⁾ 20 A with 2 x 2.5 mm² cables connected in parallel.

⁽⁵⁾ 32 A with 2 x 4 mm² cables connected in parallel.

⁽⁶⁾ 40 A with 2 x 4 mm² cables connected in parallel.

⁽⁷⁾ BTR screws: hexagon socket head. In accordance with local electrical wiring regulations, a size 4 insulated Allen key must be used (reference **LAD ALLEN4**, see page B8/29).

⁽⁸⁾ Selection according to the number of operating cycles, see AC-1 curve, page A6/30.

TeSys contactors

TeSys D, 4-pole contactors

For control in category AC-1, 20 to 200 A



LC1 DT20●●

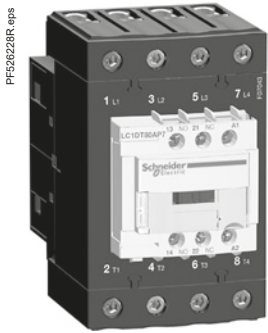

LC1 DT80A●●

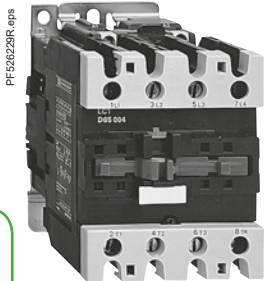

LC1 D65008●●

4-pole contactors for connection by screw clamp terminals or connectors					
Non inductive loads maximum current ($\theta \leq 60^\circ\text{C}$) utilisation category AC-1	Number of poles	Instantaneous auxiliary contacts		Basic reference, to be completed by adding the control voltage code ⁽¹⁾ Fixing ⁽²⁾	Weight ⁽³⁾

A kg

Connection by screw clamp terminals

20	4	–	1	1	LC1DT20●●	0.365
	2	2	1	1	LC1D098●●	0.365
25	4	–	1	1	LC1DT25●●	0.365
	2	2	1	1	LC1D128●●	0.365
32	4	–	1	1	LC1DT32●●	0.425
	2	2	1	1	LC1D188●●	0.425
40	4	–	1	1	LC1DT40●●	0.425
	2	2	1	1	LC1D258●●	0.425

Connection by EverLink®, BTR screw connectors

60	4	–	1	1	LC1DT60A●●	1.090
80	4	–	1	1	LC1DT80A●●	1.150

Connection by screw clamp terminals or connectors

60	2	2	–	–	LC1D40008●●	1.440
					or LP1D40008●●	2.210
80	2	2	–	–	LC1D65008●●	1.450
					or LP1D65008●●	2.220
125	4	–	–	–	LC1D80004●●	1.760
					or LP1D80004●●	2.685
	2	2	–	–	LC1D80008●●	1.840
					or LP1D80008●●	2.910
200	4	–	–	–	LC1D115004●●	2.860

4-pole contactors for connection by lugs or bars

In the references selected above, insert a figure 6 before the voltage code.

Example: LC1 DT20●● becomes LC1 DT206●●.

(1) Standard control circuit voltages (for other voltages, please consult your Regional Sales Office):

a.c. supply	Volts												
	24	42	48	110	115	220	230	240	380	400	415	440	500
LC1 D09...D150 and LC1 DT20...DT80A (LC1 D115 and D150 coils with built-in suppression device as standard)													
50/60 Hz	B7	D7	E7	F7	FE7	M7	P7	U7	Q7	V7	N7	R7	–
LC1 D80...D115													
50 Hz	B5	D5	E5	F5	FE5	M5	P5	U5	Q5	V5	N5	R5	S5
60 Hz	B6	–	E6	F6	–	M6	–	U6	Q6	–	–	R6	–

d.c. supply	Volts										
	12	24	36	48	60	72	110	125	220	250	440
LC1 D09...D25 and LC1 DT20...DT40 (coils with integral suppression device fitted as standard, by bi-directional peak limiting diode)											
U 0.75...1.25 Uc	JD	BD	CD	ED	ND	SD	FD	GD	MD	UD	RD
LC1 DT60A ...DT80A (coils with integral suppression device fitted as standard, by bi-directional peak limiting diode)											
U 0.75...1.25 Uc	JD	BD	CD	ED	ND	SD	FD	GD	MD	UD	RD
LP1D40...D80											
U 0.85...1.1 Uc	JD	BD	CD	ED	ND	SD	FD	GD	MD	UD	RD
U 0.75...1.2 Uc	JW	BW	CW	EW	–	SW	FW	–	MW	–	–
LC1 D115 (coil with built-in suppression device as standard)											
U 0.75...1.2 Uc	–	BD	–	ED	ND	SD	FD	GD	MD	UD	RD

For other voltages between 5 and 690 V, see pages B8/32 to B8/35.

(2) LC1 D09 to D38 and LC1 DT20 to DT80A: clip-on mounting on 35 mm rail AM1 DP or screw fixing.
 LC1 D80 ~: clip-on mounting on 35 mm rail AM1 DP or 75 mm rail AM1 DL or screw fixing.
 LC1 or LP1 D80 ~: clip-on mounting on 75 mm rail AM1 DL or screw fixing.
 LC1 D115 and D150: clip-on mounting on 2 x 35 mm rails AM1 DP or screw fixing.

(3) The weights indicated are for contactors with a.c. control circuit. For d.c. or low consumption control circuit, add 0.160 kg from LC1 D09 to D38, 0.075 kg from LC1 DT60A and D80A and 1 kg for LC1 D80.

TeSys contactors

TeSys D, 4-pole contactors

For control in category AC-1, 20 to 80 A

4-pole contactors					
Non inductive loads maximum current ($\theta \leq 60^\circ\text{C}$) utilisation category AC-1	Number of poles	Instantaneous auxiliary contacts		Basic reference, to be completed by adding the voltage code ⁽¹⁾	Weight ⁽³⁾
				Fixing ⁽²⁾	
A					kg
Connection by spring terminals					
20	4 –	1	1	LC1DT203●●	0.380
	2	2	1	LC1D0983●●	0.380
25	4 –	1	1	LC1DT253●●	0.380
	2	2	1	LC1D1283●●	0.380
32	4 –	1	1	LC1DT323●●	0.425
	2	2	1	LC1D1883●●	0.425
40	4 –	1	1	LC1DT403●●	0.425
	2	2	1	LC1D2583●●	0.425
Connection by EverLink®, BTR screw connectors and control circuit by spring terminals					
60	4 –	1	1	LC1DT60A3●●	1.090
80	4 –	1	1	LC1DT80A3●●	1.150

Separate components

Auxiliary contact blocks and add-on modules: see pages B8/23 to B8/29.

⁽¹⁾ Standard control circuit voltages (for other voltages, please consult your Regional Sales Office):

a.c. supply

Volts	24	42	48	110	115	220	230	240	380	400	415	440	500
LC1 D09...D25 and LC1 DT20...DT80A (coils with integral suppression device fitted as standard, by bi-directional peak limiting diode)													
50/60 Hz	B7	D7	E7	F7	FE7	M7	P7	U7	Q7	V7	N7	R7	–

d.c. supply

Volts	12	24	36	48	60	72	110	125	220	250	440
LC1 D09...D25 and LC1 DT20...DT40 (coils with integral suppression device fitted as standard, by bi-directional peak limiting diode)											
U 0.7...1.25 Uc	JD	BD	CD	ED	ND	SD	FD	GD	MD	UD	RD
LC1 DT60A...80A (coils with integral suppression device fitted as standard, by bi-directional peak limiting diode)											
U 0.75...1.25 Uc	JD	BD	CD	ED	ND	SD	FD	GD	MD	UD	RD

Low consumption

Volts	5	12	20	24	48	110	220	250
LC1 D09...D25 and LC1 DT20...DT40 (coils with integral suppression device fitted as standard, by bi-directional peak limiting diode)								
U 0.8...1.25 Uc	AL	JL	ZL	BL	EL	FL	ML	UL

For other voltages between 5 and 690 V, see pages B8/32 to B8/35.

⁽²⁾ LC1 D09 to D38 and LC1 DT20 to DT80A: clip-on mounting on 35 mm rail AM1DP or screw fixing.

⁽³⁾ The weights indicated are for contactors with a.c. control circuit. For d.c. or low consumption control circuit, add 0.160 kg from LC1 D09 to D38, 0.075 kg for LC1 DT60A and DT80A.

Contactors

TeSys contactors

For the North American market, Conforming to UL and CSA standards 25 to 160 A



LC1 D09●●



LC1 D25●●



LC1 D80A●●

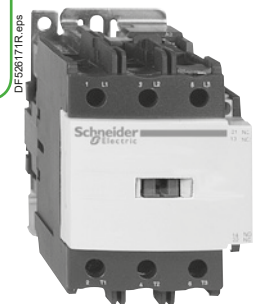

LC1 D95●●

Contactors

Standard power ratings of motors 50/60 Hz						Associated cable type 75 °C-Cu	UL continuous current	Type of contactor required Basic reference, to be completed ⁽¹⁾ Fixing, connection ⁽²⁾
Single-phase 1 Ø		3-phase 3 Ø						
120 V	240 V	208 V	240 V	480 V	600 V			
HP	HP	HP	HP	HP	HP		A	

Connection by screw clamp terminals								
1/3	1	2	2	5	7.5	AWG 18 - 10	25	LC1D09●●
0.5	2	3	3	7.5	10	AWG 18 - 10	25	LC1D12●●
1	3	5	5	10	15	AWG 18 - 8	32	LC1D18●●
2	3	7.5	7.5	15	20	AWG 14 - 6	40	LC1D25●●
2	5	10	10	20	25	AWG 14 - 6	50	LC1D32●●
2	5	10	10	20	25	AWG 14 - 6	50	LC1D38●●

Power connections by EverLink® BTR screw connectors and control by spring terminals								
3	5	10	10	30	30	AWG 16 - 2	60	LC1D40A●●
3	7.5	15	15	40	40	AWG 16 - 2	70	LC1D50A●●
5	10	20	20	40	50	AWG 16 - 2	80	LC1D65A●●
5	10	20	20	40	50	AWG 16 - 2	80	LC1D80A●●

Connection by screw clamp terminals or connectors								
7.5	15	25	30	60	60	AWG 10 - 2	110	LC1D80●●
7.5	15	25	30	60	60	AWG 10 - 2	110	LC1D95●●
-	-	30	40	75	100	AWG 8-1/0	160	LC1D115●●
-	-	40	50	100	125	AWG 8-1/0	160	LC1D150●●

Applications with High-Fault Short-Circuit ratings

High-fault short-circuit current ratings are: 100 kA (D09-80, D115-150) at 600 V with Class J fuses and 85 kA (D09-38), 100 kA (D40A-80, D115-150) at 480 V and 50 kA (D09-80, D115-150) at 600 V with circuit breakers.

Application example

For a 15 HP-230 V motor

Select a contactor type **LC1 D50A**.

Information: the contactor rating selected corresponds to "size 2", the associated cable is type AWG3 75 °C-Cu.

⁽¹⁾ Standard control circuit voltages (for other voltages, please consult your Regional Sales Office):

a.c. supply																
Volts	24	42	48	110	115	120	208	220	230	240	380	400	415	440	480	500
LC1 D09...D150 (D115 and D150 coils with built-in suppression device as standard)																
50/60 Hz	B7	D7	E7	F7	FE7	G7	LE7	M7	P7	U7	Q7	V7	N7	R7	T7	S7
LC1 D09...D65 (not available with "connection for lugs or bars")																
50 Hz	B5	D5	E5											P5		
LC1 D80...D115																
50 Hz	B5	D5	E5	F5	FE5	G5	-	M5	P5	U5	Q5	V5	N5	R5	-	S5
60 Hz	B6	-	E6	F6	-	G6	L6	M6	-	U6	Q6	-	-	R6	T6	-

d.c. supply																
Volts	12	24	36	48	60	72	110	125	220	250	440					
LC1 D09...D32 (coils with integral suppression device fitted as standard, by bi-directional peak limiting diode)																
U 0.7...1.25 Uc	JD	BD	CD	ED	ND	SD	FD	GD	MD	UD	RD					
LC1 D40A...D65A (coils with integral suppression device fitted as standard, by bi-directional peak limiting diode)																
U 0.75...1.25 Uc	JD	BD	CD	ED	ND	SD	FD	GD	MD	UD	RD					
LC1 D80 and D95																
U 0.85...1.1 Uc	JD	BD	CD	ED	ND	SD	FD	GD	MD	UD	RD					
U 0.75...1.2 Uc	JW	BW	CW	EW	-	SW	FW	-	MW	-	-					
LC1 D115 and D150 (coils with built-in suppression device as standard)																
U 0.75...1.2 Uc	-	BD	-	ED	ND	SD	FD	GD	MD	UD	RD					

Low consumption										
Volts ---	5	12	20	24	48	72	110	220	250	
LC1 D09...D38 (coils with integral suppression device fitted as standard, by bi-directional peak limiting diode)										
U 0.8...1.25 Uc	AL	JL	ZL	BL	EL	SL	FL	ML	UL	

⁽²⁾ **LC1 D09 to D65A**: clip-on mounting on 35 mm L J rail **AM1 DP** or screw fixing.
LC1 D80 and LC1 D95: clip-on mounting on 35 mm L J rail **AM1 DP** or 75 mm L J rail **AM1 DL** or screw fixing.
LC1 D115 and D150: clip-on mounting on 2 x 35 mm L J rails **AM1 DP** or screw fixing.



TeSys D Green

The dark grey body identifies the new generation of contactors.

TeSys D Green belongs to it, bringing valuable advantages:

- 80 % less consumption than TeSys D with standard coil, reduced heating
- suitable for direct control by PLC output up to 37 kW (80 A)
- coil embedded electronic control accepting both AC and DC supply in a wide voltage band (except BBE-24 V DC).

TeSys D Green dimensions similar to TeSys D AC coil, making it fully compatible with all TeSys D auxiliaries and accessories.

TeSys D Green is specifically designed for activation by its dedicated wide band coils.



Contactors

TeSys D Green, enriching TeSys D family

TeSys D conventional contactors 9 to 150 A, for motor control and other applications.

TeSys D Green delivers a consistent low consumption range of contactors from 9 A to 80 A, covering control voltage from 24 to 250 V, with same coils for AC and DC.



When implemented with other Schneider Electric products*, TeSys D Green contactors are part of a comprehensive solution that is ideal for all types of industrial machines and processes.



TeSys Solink + PLC

SoLink ensures the compatibility of circuit breaker and contactor assemblies with screw clamp terminals to the RJ45 connection system. It also can be used with the TeSys D Green BBE offer. With SoLink, we provide prewired motor starters ready to be connected to PLC I/O, which saves you time and labor.



TeSys LR9D

By combining a TeSys D Green contactor with our new TeSys LR9D electronic overload relay, you will have less heat generation, and further reduce energy consumption.



* such as PLC I/O type M580, M340, M221 or M241 or extended I/O type Advantys STB range, or in association with electronic overload relays LR9D or TeSys T.



Highly competitive coil consumption

Small changes can generate big savings. The new TeSys D Green contactor is equipped with an innovative electronic coil. These electronic-coil contactors require **up to 80 % less energy** than electro-mechanical contactors. This innovation results in concrete values: for example, large plants can noticeably reduce their energy bills and heat dissipation in cabinet.

Available in



09-12-18 A

25-32-38 A

40-50-65-80 A

Coil currents comparison

TeSys D Green (AC/DC coil) vs TeSys D (AC, DC coils)

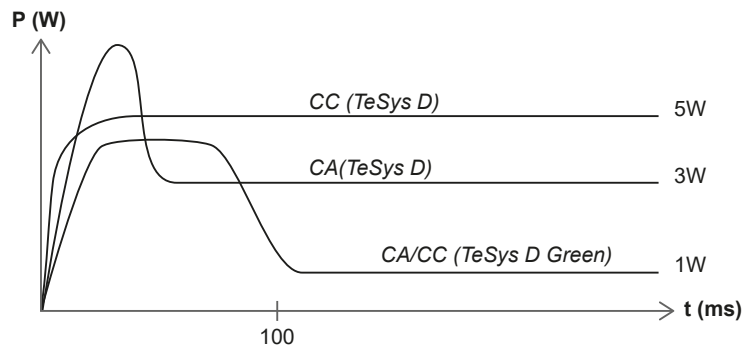

TeSys D Green brings a significant reduction of energy consumption.

TeSys D Green ("BBE" coil) vs TeSys D (low consumption "BL" coil)

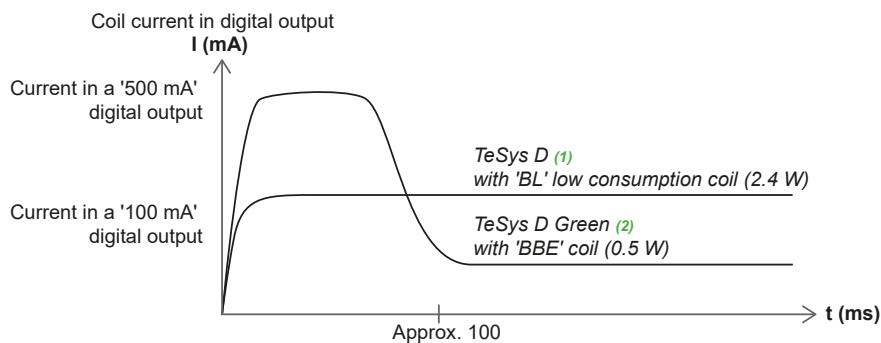

(1) Up to 38 A.
(2) 40 to 80 A.

TeSys D Green is well adapted to direct control by PLC static outputs, even in its high ratings.

References

TeSys contactors

TeSys D Green

Coordination with PLC DC and relay output modules

Laboratory tests have been carried out in order to validate trouble free contactor closings and openings with different PLC output modules.
The coil must be defined according to the contactor rating range and output module.
See selection table below.

The PLC your are using				>>>	Compatible contactors ⁽¹⁾	Coil code
PLC type	Output type	Output I (A)	Output module commercial reference			
M221 / M241 / M251	Static output: 24 V DC	0.5	TM3DQ8●●● and Q16●●● (T, TG, U, UG)	>>>	LC1D09●● to LC1D38●●, LC1D40A●●● to LC1D80A, LC1DT60A●●● to LC1DT80A●●●	BL, BNE BBE
		0.3 (sealed) 0.8 (inrush)	TM3XTYS4	>>>	LC1D40A●●● to LC1D80A, LC1DT60A●●● to LC1DT80A●●●	BBE, BD, BNE
		0.1	TM3DQ16●● and Q32●● (TK, UK)	>>>	LC1D09●● to LC1D38●●	BL
	Relay output: 24 V DC / 230 V AC	2	TM3DQ8 and DQ16 (R,RG), TM3DM8 and DM24 (R,RG)	>>>	LC1D09●● to LC1D38●●, LC1D40A●●● to LC1D80A, LC1DT60A●●● to LC1DT80A●●●	Code of any DC coil up to 24 V or any AC coil up to 230 V
M340 / M580	Static output: 24 V DC	0.5	BMXDDO1602 and DM16022	>>>	LC1D09●● to LC1D38●●, LC1D40A●●● to LC1D80A, LC1DT60A●●● to LC1DT80A●●●	BL, BNE BBE
		0.1	BMXDDO3202, BMXDDM3202K, BMXDDO6402K	>>>	LC1D09●● to LC1D38●●	BL
	Relay output: 24 V DC / 230 V AC	2	BMXDRA0805 and DM16025	>>>	LC1D09●● to LC1D38●●, LC1D40A●●● to LC1D80A, LC1DT60A●●● to LC1DT80A●●●	Code of any DC coil up to 24 V or any AC coil up to 230 V
	Triac output: 230 V AC	0.6	BMXDAO1605	>>>	LC1D09●● to LC1D38●●, LC1D40A●●● to LC1D80A●●●, LC1DT60A●●● to LC1DT80A●●●	Code of any AC coil up to 230 V (P7 code = 230 V)
ADVANTYS	Static output: 24 V DC	0.5	STBDDO3200	>>>	LC1D09●● to LC1D38●●, LC1D40A●●● to LC1D80A, LC1DT60A●●● to LC1DT80A●●●	BL, BNE BBE
	Triac output: 230 V AC	2	STBDAO8210	>>>	LC1D09●● to LC1D38●●, LC1D40A●●● to LC1D80A, LC1DT60A●●● to LC1DT80A●●●	Code of any AC coil up to 230 V (P7 code = 230 V AC)

Coils consumption characteristics

Coil type	Uc DC - min -max	Average consumption at UC DC / 20 °C	
		Inrush	Sealed
BL	24 V - 0.8 Uc to 1.1 Uc	2.4 W - 2.4 VA	2.4 W - 2.4 VA
BNE		14 W - 14 VA	0.7 W - 0.7 VA
BBE		11 W - 11 VA	0.5 W - 0.5 VA

(1) Replace dot by coil code. Ex LC1D09●● becomes LC1D09BL.

References

TeSys D Green contactors

For motor control up to 37 kW / 400 V Category AC-3



LC1D09●●●



LC1D40A●●●

3-pole contactors

Standard power ratings of 3-phase motors 50-60 Hz in category AC-3 ($\theta \leq 60^\circ\text{C}$)						Rated operational current in AC-3 440 V up to	Instan- taneous auxiliary contacts	Basic reference, to be completed by adding the control voltage code	Weight
220 V 230 V	380 V 400 V	415 V	440 V	500 V	660 V 690 V				

kW	kW	kW	kW	kW	kW	A			kg
----	----	----	----	----	----	---	--	--	----

Connection by screw clamp terminals

2.2	4	4	4	5.5	5.5	9	1	1	LC1D09●●●	0.368
3	5.5	5.5	5.5	7.5	7.5	12	1	1	LC1D12●●●	0.373
4	7.5	9	9	10	10	18	1	1	LC1D18●●●	0.378
5.5	11	11	11	15	15	25	1	1	LC1D25●●●	0.433
7.5	15	15	15	18.5	18.5	32	1	1	LC1D32●●●	0.438
9	18.5	18.5	18.5	18.5	18.5	38	1	1	LC1D38●●●	0.442

Power connections by EverLink® BTR⁽²⁾ screw connectors and control by screw clamp terminal

11	18.5	22	22	22	30	40	1	1	LC1D40A●●●	0.992
15	22	25	30	30	33	50	1	1	LC1D50A●●●	0.997
18.5	30	37	37	37	37	65	1	1	LC1D65A●●●	1.002
22	37	37	37	37	37	66	1	1	LC1D80A●●●	1.002

Connection for lugs or bars⁽⁴⁾

For LC1D40A to LC1D80A, insert a figure 6 before the voltage code.

Example: LC1D40A●●● becomes LC1D40A6●●●

Auxiliary contact blocks and add-on modules

See pages B8/23 to B8/29.

Control voltage codes

AC/DC or 24 V DC supply				
Volts	24 (DC only)	24-60	48-130	100-250
LC1D09 ... D38, LC1D40A ... D80A				
U 0.85...1.1 Uc		BNE	EHE	KUE
LC1D09 ... D38				
U 0.8 ... 1.2 Uc	BNE			
LC1D40A ... D80A				
U 0.8...1.2 Uc	BBE			

(1) LC1D09 to D80A: clip-on mounting on 35 mm rail AM1 DP or screw fixing.

(2) BTR screws: hexagon socket head. In accordance with local electrical wiring regulations, a size 4 insulated Allen key must be used (reference LAD ALLEN4, see B8/29).

(3) Please consult your Regional Sales Office.

References

TeSys D Green contactors

For load control from 25 to 80 A Category AC-1



LC1 D09●●●



LC1 D40A●●●



LC1 DT60A●●●

3-pole contactors

Non inductive loads maximum current ($\theta \leq 60^\circ\text{C}$) utilisation category AC-1	Number of poles	Instantaneous auxiliary contacts	Partial reference, to be completed by adding the control voltage code	Weight
			Fixing ⁽¹⁾	

A					kg
Connection by screw clamp terminals					
25	3	1	1	LC1D09●●●	0.368
				or LC1D12●●●	0.373
32	3	1	1	LC1D18●●●	0.378
40	3	1	1	LC1D25●●●	0.433
50	3	1	1	LC1D32●●●	0.438
				or LC1D38●●●	0.442
Connection by EverLink®, BTR screw connectors ⁽²⁾					
60	3	1	1	LC1D40A●●●	0.992
80	3	1	1	LC1D50A●●●	0.997
				or LC1D65A●●● ⁽³⁾	1.002
				or LC1D80A●●● ⁽³⁾	1.002

Connection for lugs or bars

For LC1D40A to LC1D80A, insert a figure 6 before the voltage code.
Example: LC1D40A●●● becomes LC1D40A6●●●

4-pole contactors

Connection by EverLink®, BTR ⁽²⁾ screw connectors					
60	4	1	1	LC1DT60A●●●	1.230
80	4	1	1	LC1DT80A●●●	1.290

Connection for lugs or bars

For LC1DT60A to LC1DT80A, insert a figure 6 before the voltage code.
Example: LC1DT60A●●● becomes LC1DT60A6●●●

4-pole changeover contactors

Connection by EverLink®, BTR ⁽²⁾ screw connectors					
60	4	1	1	LC2DT60A●●●	2.460
80	4	1	1	LC2DT80A●●●	2.580

Control voltage codes

AC/DC 24 V DC supply				
Volts	24 (DC only)	24-60	48-130	100-250
LC1 D09...D80A and LC●DT60A...DT80A				
U 0.85 ... 1.1 Uc		BNE	EHE	KUE
LC1D09 ... D38				
U 0.8 ... 1.2 Uc	BNE			
LC1D40 to LC1D80A, LC●DT60A to LC●DT80A				
U 0.8...1.2 Uc	BBE			

- ⁽¹⁾ LC1 D09 to D80A, LC●DT60A and LC●DT80A: clip-on mounting on 35 mm rail AM1 DP or screw fixing.
- ⁽²⁾ BTR screws: hexagon socket head. In accordance with local electrical wiring regulations, a size 4 insulated Allen key must be used (reference LAD ALLEN4, see page B8/29).
- ⁽³⁾ Selection according to the number of operation cycles, consult online datasheets for values.

References

TeSys D Green contactors

For North American market, conforming to UL and CSA standards 25 to 80 A



LC1 D09●●●



LC1 D40A●●●

Contactors

Standard power ratings of motors 50/60 Hz						Associated cable type 75 °C-Cu	Continuous current	Type of contactor required Partial reference, to be completed by adding the control voltage code Fixing, connection ⁽¹⁾
Single-phase 1 Ø		3-phase 3 Ø						
115 V	230 V	200 V	230 V	460 V	575 V			
	240 V	208 V	240 V	480 V	600 V			
HP	HP	HP	HP	HP	HP		A	

Connection by screw clamp terminals

1/3	1	2	2	5	7.5	AWG 18 - 10	25	LC1D09●●●
0.5	2	3	3	7.5	10	AWG 18 - 10	25	LC1D12●●●
1	3	5	5	10	15	AWG 18 - 8	32	LC1D18●●●
2	3	7.5	7.5	15	20	AWG 14 - 6	40	LC1D25●●●
2	5	10	10	20	25	AWG 14 - 6	50	LC1D32●●●

Power connections by EverLink® BTR ⁽²⁾ screw connectors and control by spring terminals

3	5	10	10	30	30	AWG 16 - 2	60	LC1D40A●●●
3	7.5	15	15	40	40	AWG 16 - 2	70	LC1D50A●●●
5	10	20	20	40	50	AWG 16 - 2	80	LC1D65A●●●
5	10	20	20	40	50	AWG 16 - 2	80	LC1D80A●●●

Connection for lugs or bars

For LC1D40A to LC1D80A, insert a figure 6 before the voltage code.

Example: LC1D40A●●● becomes LC1D40A6●●●

Applications with High-Fault Short-Circuit Current ratings

High-fault short-circuit current ratings are: 100 kA at 600 V with Class J fuses and 85 kA (D09-38), 100 kA (D40A-65A) at 480 V and 50 kA at 600 V with circuit breakers.

Control voltage codes

AC/DC 24 V DC supply

Volts	24 (DC only)	24-60	48-130	100-250
LC1D09 ... D32, LC1D40A ... D80A				
U 0.85 ... 1.1 Uc		BNE	EHE	KUE
LC1D09 ... D38				
U 0.8 ... 1.2 Uc		BNE		
LC1D40A ... D80A				
U 0.8...1.2 Uc		BBE		

⁽¹⁾ LC1 D09 to D80: clip-on mounting on 35 mm rail AM1 DP or screw fixing.

⁽²⁾ BTR screws: hexagon socket head. In accordance with local electrical wiring regulations, a size 4 insulated Allen key must be used (reference LAD ALLEN4, see page B8/29).



TeSys contactors

TeSys D, 3-pole reversing contactors for motor control up to 75 kW at 400 V, in category AC-3 Horizontally mounted, pre-assembled



LC2 D12●●



LC2 D65A●●



LC2 D115●●

3-pole reversing contactors for connection by screw clamp terminals

Pre-wired power connections.

Standard power ratings of 3-phase motors 50-60 Hz in category AC-3 ($\theta \leq 60^\circ\text{C}$)							Rated operational current in AC-3 440 V up to	Instan- taneous auxiliary contacts per contactor	Contactors supplied with coil Basic reference, to be completed by adding the control voltage code ⁽²⁾		Weight ⁽³⁾
220 V	380 V	415 V	440 V	500 V	660 V	1000 V			Fixing ⁽¹⁾		
230 V	400 V				690 V						kg
kW	kW	kW	kW	kW	kW	kW	A				

With mechanical interlock, without electrical interlocking, for connection by screw clamp terminals or connectors

2.2	4	4	4	5.5	5.5	-	9	1	1	LC2D09●● ⁽⁴⁾	0.687
3	5.5	5.5	5.5	7.5	7.5	-	12	1	1	LC2D12●● ⁽⁴⁾	0.697
4	7.5	9	9	10	10	-	18	1	1	LC2D18●● ⁽⁴⁾	0.707
5.5	11	11	11	15	15	-	25	1	1	LC2D25●● ⁽⁴⁾	0.787
7.5	15	15	15	18.5	18.5	-	32	1	1	LC2D32●● ⁽⁴⁾	0.797
9	18.5	18.5	18.5	18.5	18.5	-	38	1	1	LC2D38●● ⁽⁴⁾	0.807
11	18.5	22	22	22	30	-	40	1	1	LC2D40A●●	1.870
15	22	25	30	30	33	-	50	1	1	LC2D50A●●	1.880
18.5	30	37	37	37	37	-	65	1	1	LC2D65A●●	1.890
22	37	45	45	55	45	-	80	1	1	LC2D80●●	3.200
25	45	45	45	55	45	-	95	1	1	LC2D95●●	3.200

With mechanical interlock and electrical interlocking, for connection by screw clamp terminals or connectors

30	55	59	59	75	80	65	115	1	1	LC2D115●●	6.350
40	75	80	80	90	100	75	150	1	1	LC2D150●●	6.400

Connection by lugs or bars

For reversing contactors LC2 D09 to LC2 D38, LC2 D115 and LC2 D150, in the references selected above, insert a figure 6 before the voltage code. Example: LC2 D09●● becomes LC2 D096●●.

To build a 40 to 65 A reversing contactor, for connection by lugs, order 2 contactors LC1 D●●A6 and mechanical interlock LAD 4CM (see page B8/30).

Component parts

Auxiliary contact blocks and add-on modules: see pages B8/23 to B8/29.

⁽¹⁾ LC2 D09 to D65A: clip-on mounting on 35 mm rail AM1 DP or screw fixing.

LC2 D80 and D95: clip-on mounting on 35 mm rail AM1 DP or 75 mm rail AM1 DL or screw fixing.

LC2 D115 and D150: clip-on mounting on 35 mm rail AM1 DP or screw fixing.

⁽²⁾ Standard control circuit voltages (for other voltages between 16 and 690 V, please consult your Regional Sales Office):

a.c. supply

Volts	24	42	48	110	115	220	230	240	380	400	415	440	500
-------	----	----	----	-----	-----	-----	-----	-----	-----	-----	-----	-----	-----

LC2 D09...D150 (D115 and D150 coils with built-in suppression device as standard)

50/60 Hz	B7	D7	E7	F7	FE7	M7	P7	U7	Q7	V7	N7	R7	S7
----------	----	----	----	----	-----	----	----	----	----	----	----	----	----

LC2 D80...D115

50 Hz	B5	D5	E5	F5	FE5	M5	P5	U5	Q5	V5	N5	R5	S5
60 Hz	B6	-	E6	F6	-	M6	-	U6	Q6	-	-	R6	-

d.c. supply

Volts	12	24	36	48	60	72	110	125	220	250	440
-------	----	----	----	----	----	----	-----	-----	-----	-----	-----

LC2 D09...D38 (coils with integral suppression device fitted as standard, by bi-directional peak limiting diode)

U 0.7...1.25 U _c	JD	BD	CD	ED	ND	SD	FD	GD	MD	UD	RD
-----------------------------	----	----	----	----	----	----	----	----	----	----	----

LC2 D40A...D65A (coils with integral suppression device fitted as standard, by bi-directional peak limiting diode)

U 0.75...1.25 U _c	JD	BD	CD	ED	ND	SD	FD	GD	MD	UD	RD
------------------------------	----	----	----	----	----	----	----	----	----	----	----

Low consumption

Volts	5	12	20	24	48	110	220	250
-------	---	----	----	----	----	-----	-----	-----

LC2 D09...D38 (coils with integral suppression device fitted as standard, by bi-directional peak limiting diode)

U 0.8...1.25 U _c	AL	JL	ZL	BL	EL	FL	ML	UL
-----------------------------	----	----	----	----	----	----	----	----

For other voltages between 5 and 690 V, see pages B8/32 to B8/35.

⁽³⁾ The weights indicated are for contactors with a.c. control circuit. For d.c. or low consumption control circuit, add 0.330 kg for LC2 D09 to D38, 0.150 kg for LC1 D40A to D65A.

⁽⁴⁾ For reversing contactors with electrical interlocking pre-wired at the factory, add suffix V to the references selected above. Example: LC2 D09P7 becomes LC2 D09P7V.

Note: when assembling a reversing contactor, it is good practice to incorporate a 50 ms time delay.

TeSys contactors

TeSys D, 3-pole reversing contactors for motor control up to 15 kW at 400 V, in category AC-3 Horizontally mounted, pre-assembled



LC2 D123●●

3-pole reversing contactors, for connection by spring terminals

Pre-wired power connections.

Mechanical interlock without electrical interlocking.

Standard power ratings of 3-phase motors 50-60 Hz in category AC-3 ($\theta \leq 60^\circ\text{C}$)							Rated operational current in AC-3 440 V up to	Instan-taneous auxiliary contacts per contactor	Contactors supplied with coil Basic reference, to be completed by adding the voltage code ⁽²⁾	Weight ⁽³⁾
220 V	380 V	415 V	440 V	500 V	660 V	690 V				
kW	kW	kW	kW	kW	kW	A	Fixing ⁽¹⁾			kg
For connection by spring terminals										
2.2	4	4	4	5.5	5.5	9	1	1	LC2D093●●	0.687
3	5.5	5.5	5.5	7.5	7.5	12	1	1	LC2D123●●	0.697
4	7.5	9	9	10	10	18	1	1	LC2D183●●	0.707
5.5	11	11	11	15	15	25	1	1	LC2D253●●	0.787
7.5	15	15	15	18.5	18.5	32 ⁽⁴⁾	1	1	LC2D323●●	0.797
Power connection by EverLink[®], BTR screw connectors ⁽⁵⁾ and control by spring terminals										
11	18.5	22	22	22	30	40	1	1	LC2D40A3●●	1.870
15	22	25	30	30	33	50	1	1	LC2D50A3●●	1.880
18.5	30	37	37	37	37	65	1	1	LC2D65A3●●	1.890

For connection by Faston connectors

All power connections are to be made by the customer.

These contactors are fitted with Faston connectors: 2 x 6.35 mm on the power poles and 1 x 6.35 mm on the coil terminals.

For reversing contactors LC2 D09 and LC2 D12 only, in the references selected above, replace the figure 3 before the voltage code with a figure 9.

Example: LC2 D093●● becomes LC2 D099●●.

Component parts

Auxiliary contact blocks and add-on modules: see pages B8/23 to B8/29.

(1) LC2 D09 to D32: clip-on mounting on 35 mm rail AM1 DP or screw fixing.

(2) Standard control circuit voltages (for other voltages, please consult your Regional Sales Office):

a.c. supply

Volts	24	42	48	110	115	220	230	240	380	400	415	440	500
-------	----	----	----	-----	-----	-----	-----	-----	-----	-----	-----	-----	-----

LC2 D09...D65A

50/60 Hz	B7	D7	E7	F7	FE7	M7	P7	U7	Q7	V7	N7	R7	S7
----------	----	----	----	----	-----	----	----	----	----	----	----	----	----

d.c. supply

Volts	12	24	36	48	60	72	110	125	220	250	440
-------	----	----	----	----	----	----	-----	-----	-----	-----	-----

LC2 D09...D32 (coils with integral suppression device fitted as standard, by bi-directional peak limiting diode)

U 0.7...1.25 Uc	JD	BD	CD	ED	ND	SD	FD	GD	MD	UD	RD
-----------------	----	----	----	----	----	----	----	----	----	----	----

LC2 D40A...D65A (coils with integral suppression device fitted as standard, by bi-directional peak limiting diode)

U 0.75...1.25 Uc	JD	BD	CD	ED	ND	SD	FD	GD	MD	UD	RD
------------------	----	----	----	----	----	----	----	----	----	----	----

Low consumption

Volts	5	12	20	24	48	110	220	250
-------	---	----	----	----	----	-----	-----	-----

LC2 D09...D32 (coils with integral suppression device fitted as standard, by bi-directional peak limiting diode)

U 0.8...1.25 Uc	AL	JL	ZL	BL	EL	FL	ML	UL
-----------------	----	----	----	----	----	----	----	----

For other voltages between 5 and 690 V, see pages B8/32 to B8/35.

(3) The weights indicated are for reversing contactors with a.c. control circuit. For d.c. or low consumption control circuit, add 0.330 kg for LC2 D09 to D38, 0.150 kg for LC1 D40A to D65A.

(4) Must be wired with 2 x 4 mm² cables in parallel on the upstream side. On the downstream side, outgoing terminal block LAD 331 may be used (Quickfit technology, see page B1/18). When wired with a single cable, the product is limited to 25 A (11 kW/400 V motors).

(5) BTR screws: hexagon socket head. In accordance with local electrical wiring regulations, a size 4 insulated Allen key must be used (reference LAD ALLEN4, see page B8/29).

References

TeSys D Green reversing contactors

For motor control up to 37 kW / 400 V Category AC-3



LC2 D09●●●



LC2 D40A●●●

3-pole reversing contactors

Pre-wired power connections

Standard power ratings of 3-phase motors 50-60 Hz in category AC-3 ($\theta \leq 60^\circ\text{C}$)						Rated operational current in AC-3 440 V up to	Instantaneous auxiliary contacts per contactor	Contactors supplied with coil Partial reference, to be completed by adding the control voltage code	Weight
220 V	380 V	415 V	440 V	500 V	660 V				
230 V	400 V				690 V			Fixing ⁽¹⁾	

kW	kW	kW	kW	kW	kW	A				kg
With mechanical interlock, without electrical interlocking, for connection by screw clamp terminals or Everlink BTR screw connectors ^{(2) (3)}										
2.2	4	4	4	5.5	5.5	9	1	1	LC2D09●●●	0.783
3	5.5	5.5	5.5	7.5	7.5	12	1	1	LC2D12●●●	0.793
4	7.5	9	9	10	10	18	1	1	LC2D18●●●	0.803
5.5	11	11	11	15	15	25	1	1	LC2D25●●●	0.913
7.5	15	15	15	18.5	18.5	32	1	1	LC2D32●●●	0.923
9	18.5	18.5	18.5	18.5	18.5	38	1	1	LC2D38●●●	0.933
11	18.5	22	22	22	30	40	1	1	LC2D40A●●● ⁽²⁾	2.154
15	22	25	30	30	33	50	1	1	LC2D50A●●● ⁽²⁾	2.164
18.5	30	37	37	37	37	65	1	1	LC2D65A●●● ⁽²⁾	2.174
22	37	37	37	37	37	66	1	1	LC2D80A●●● ⁽²⁾	2.174

Auxiliary contact blocks and add-on modules

See pages B8/23 to B8/29.

Coil voltage codes

AC/DC 24 V DC supply

Volts	24 (DC only)	24-60	48-130	100-250
LC2D09...D32, LC2D40A...D80A				
U 0.85...1.1 Uc		BNE	EHE	KUE
LC2D09...D38				
U 0.8...1.2 Uc		BNE		
LC2 D40A...D80A				
U 0.8...1.2 Uc		BBE		

⁽¹⁾ LC2 D09 to D80A: clip-on mounting on 35 mm rail AM1 DP or screw fixing.

⁽²⁾ BTR screws: hexagon socket head. In accordance with local electrical wiring regulations, a size 4 insulated Allen key must be used (reference LAD ALLEN4, see page B8/29).

⁽³⁾ Electrical interlocking is recommended when 2 orders (direct and reverse) could appeared in the same time.

TeSys contactors

TeSys D, 4-pole changeover contactor pairs for control in category AC-1, 20 to 200 A



LC2 DT20●●

Pre-assembled. Pre-wired power connections

For connection by screw clamp terminals or connectors

LC2 DT20 to LC2 DT40: mechanical interlock without electrical interlocking.

LC2 D80004: order separately 2 auxiliary contact blocks LAD N●1 to obtain electrical interlocking between the 2 contactors (see page B8/23).

For electrical interlocking incorporated in the mechanical interlock, please consult your Regional Sales Office.

LC2 D115004: mechanical interlock with integral, pre-wired electrical interlocking.

Utilisation category AC-1 Non-inductive loads Maximum rated operational current ($\theta \leq 60^\circ\text{C}$)	Instantaneous auxiliary contacts per contactor		Contactors supplied with coil	Weight kg
			Basic reference, to be completed by adding the voltage code ⁽¹⁾ Fixing ⁽²⁾	
A				
20	1	1	LC2DT20●●	0.730
25	1	1	LC2DT25●●	0.730
32	1	1	LC2DT32●●	0.850
40	1	1	LC2DT40●●	0.850
125	–	–	LC2D80004●●	3.200
200	–	–	LC2D115004●●	7.400

For connection by lugs or bars

20	1	1	LC2DT206●●	0.730
25	1	1	LC2DT256●●	0.730
32	1	1	LC2DT326●●	0.850
40	1	1	LC2DT406●●	0.850

For customer assembly

For connection by screw clamp terminals or connectors

60	1	1	LC1DT60A●● ⁽³⁾	–
80	1	1	LC1DT80A●● ⁽³⁾	–

For connection by lugs or bars

60	1	1	LC1DT60A6●● ⁽³⁾	–
80	1	1	LC1DT80A6●● ⁽³⁾	–

Auxiliary contact blocks and add-on modules: see pages B8/23 to B8/29.

Note: when assembling changeover contactor pairs, it is good practice to incorporate a 50 ms time delay.

⁽¹⁾ See note (1) on next page.

⁽²⁾ LC2 DT20 to LC2 DT80: clip-on mounting on 35 mm rail AM1 DP or screw fixing.

LC2 D80: clip-on mounting on 35 mm rail AM1 DP or 75 mm rail AM1 DL or screw fixing.

LC2 D115: clip-on mounting on 2 x 35 mm rails AM1 DP or screw fixing.

⁽³⁾ For these operational currents, order 2 identical contactors and a mechanical interlock LAD 4CM (see page B8/30).

TeSys contactors

TeSys D, 4-pole changeover contactor pairs for control in category AC-1, 20 to 80 A

Pre-assembled. Pre-wired power connections

For connection by spring terminals.

Utilisation category AC-1 Non-inductive loads Maximum rated operational current ($\theta \leq 60^\circ\text{C}$)	Instantaneous auxiliary contacts per contactor		Contactors supplied with coil Basic reference, to be completed by adding the control voltage code ⁽¹⁾ Fixing ⁽²⁾

A			
20	1	1	LC2DT203●●

For customer assembly

Power connection by EverLink®, BTR screw connectors ⁽³⁾ and control by spring terminals

60	1	1	LC1DT60A3●● ⁽⁴⁾
80	1	1	LC1DT80A3●● ⁽⁴⁾

Separate components

Auxiliary contact blocks and add-on modules: see pages B8/23 to B8/29.

⁽¹⁾ Standard control circuit voltages (for other voltages, please consult your Regional Sales Office):

a.c. supply													
Volts	24	42	48	110	115	220	230	240	380	400	415	440	500
LC2 DT20...DT40, LC2 DT60A...DT80A													
50/60 Hz	B7	D7	E7	F7	FE7	M7	P7	U7	Q7	V7	N7	R7	-
LC2 D80004...D115004													
50 Hz	B5	D5	E5	F5	FE5	M5	P5	U5	Q5	V5	N5	R5	S5
60 Hz	B6	-	E6	F6	-	M6	-	U6	Q6	-	-	R6	-

d.c. supply													
Volts	12	24	36	48	60	72	110	125	220	250	440		
LC2 DT20...DT40, LC1 DT60...DT80 (coils with integral suppression device fitted as standard, by bi-directional peak limiting diode)													
U 0.7...1.25 Uc	JD	BD	CD	ED	ND	SD	FD	GD	MD	UD	RD		

Low consumption													
Volts	5	12	20	24	48	110	220	250					
LC2 DT20...DT40 (coils with integral suppression device fitted as standard, by bi-directional peak limiting diode)													
U 0.8...1.25 Uc	AL	JL	ZL	BL	EL	FL	ML	UL					

For other voltages between 5 and 690 V, see pages B8/32 to B8/35.
⁽²⁾ Clip-on mounting on 35 mm rail **AM1 DP** or screw fixing.
⁽³⁾ BTR screws: hexagon socket head. In accordance with local electrical wiring regulations, a size 4 insulated Allen key must be used (reference **LAD ALLEN4**, see page B8/29).
⁽⁴⁾ For these operational currents, order 2 identical contactors and a mechanical interlock **LAD 4CM** (see page B8/30).

TeSys contactors

For switching 3-phase capacitor banks, used for power factor correction
Direct connection without choke inductors

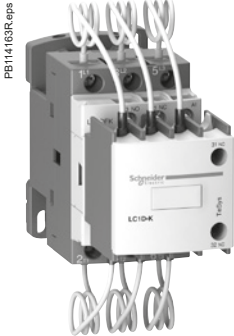

LC1 DFK●●

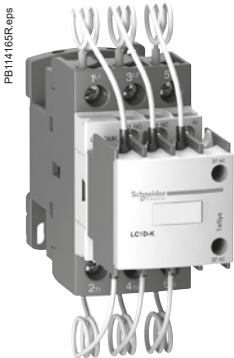

LC1 DGK●●, LC1 DLK●●, LC1 DMK●●

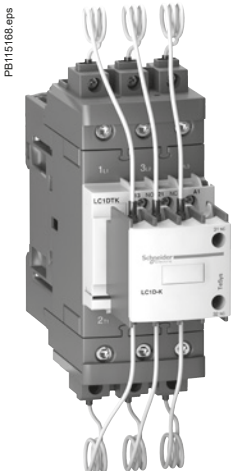

LC1 DPK●●, LC1 DTK●●

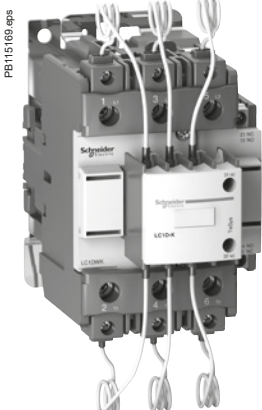

LC1 DWK12●●

Dimensions, schemes:
page B8/87

Special contactors

Special contactors **LC1 D●K** are designed for switching 3-phase, single or multiple-step capacitor banks (up to 6 steps). Over 6 steps, it is recommended to use chokes in order to limit the inrush current and thus improve the lifetime of the installation. The contactors are conform to standards IEC 60070 and 60831, UL and CSA.

Contactor applications

Specification

Contactors fitted with a block of early make poles and damping resistors, limiting the value of the current on closing to 60 In max.

This current limitation increases the life of all the components of the installation, in particular that of the fuses and capacitors.

Operating conditions

Short-circuit protection must be provided by gI type fuses rated at 1.7...2 In.

It will ensure the service continuity of the whole installation in case of a capacitor contactor end of life

Maximum operational power

The power values given in the selection table below are for the following operating conditions:

Prospective peak current at switch-on	LC1 D●K	200 In
Maximum operating rate	LC1 DFK, DGK, DLK, DMK	240 operating cycles/hour
	LC1 DPK, DTK, DWK	100 operating cycles/hour
Electrical durability at nominal load	All contactor ratings	400 V 300 000 operating cycles
		690 V 200 000 operating cycles

Operational power at 50/60 Hz ⁽¹⁾ $\theta \leq 60^\circ\text{C}$ ⁽²⁾				Instantaneous auxiliary contacts		Tightening torque on cable end	Basic reference, to be completed by adding the voltage code ⁽³⁾	Weight
230 V	400 V	440 V	690 V	N/O	N/C	N.m		kg
kVAR	kVAR	kVAR	kVAR				LC1DFK●●	0.430
7	12.5	12.5	21	1	2	1.7		
9.5	16.7	16.7	28.5	1	2	2.5	LC1DGK●●	0.450
11	20	21	33	1	2	2.5	LC1DLK●●	0.600
14	25	27	42	1	2	2.5	LC1DMK●●	0.630
17	30	32	50	1	2	5	LC1DPK●●	1.300
22	40	43	67	1	2	5	LC1DTK●●	1.300
35	63	67	104	1	2	9	LC1DWK12●●	1.650

Switching of multiple-step capacitor banks (with equal or different power ratings)

The correct contactor for each step is selected from the above table, according to the power rating of the step to be switched.

Example: 50 kVAR 3-step capacitor bank. Temperature: 50 °C and U = 400 V or 440 V.

One 25 kVAR step: contactor LC1 DMK, one 15 kVAR step: contactor LC1 DGK, and one 10 kVAR step: contactor LC1 DFK.

(1) Operational power of the contactor according to the scheme on the page opposite.

(2) The average temperature over a 24-hour period, in accordance with standards IEC 60070 and 60831 is 45 °C.

(3) Standard control circuit voltages (the delivery time is variable, please consult your Regional Sales Office):

Volts	24	48	110	120	220	230	240	380	400	415	440
50/60 Hz	B7	E7	F7	G7	M7	P7	U7	Q7	V7	N7	R7

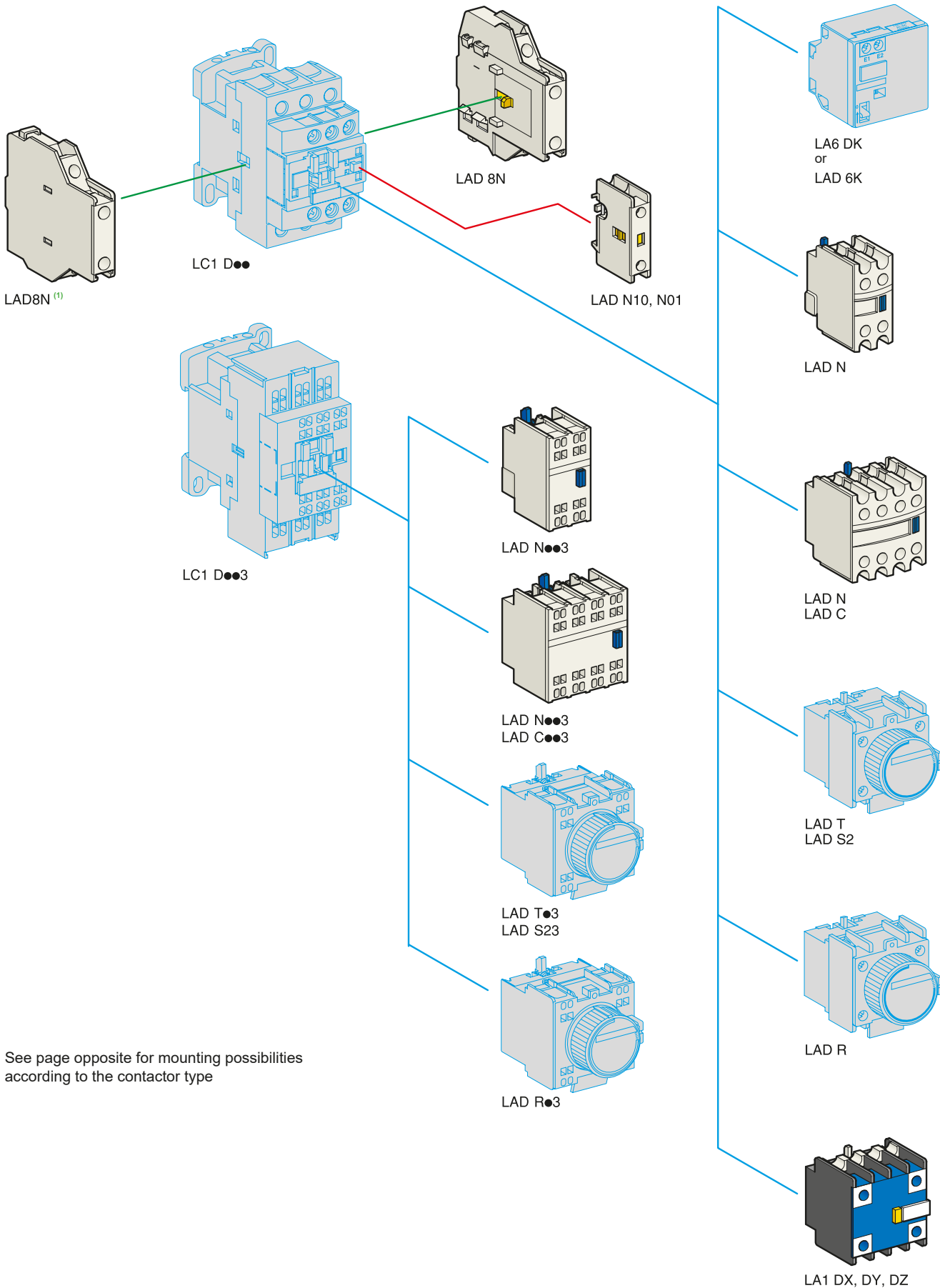

See page opposite for mounting possibilities according to the contactor type

⁽¹⁾ No left side mounting on TeSys D Green contactors.





TeSys contactors

TeSys D contactors and reversing contactors

Instantaneous auxiliary contact blocks

Instantaneous auxiliary contact blocks for connection by screw clamp terminals

For use in normal operating environments

Clip-on mounting	Number of contacts per block	Composition					Reference
							
Front	1	-	-	-	1	-	LADN10
		-	-	-	-	1	LADN01
	2	-	-	-	1	1	LADN11
		-	-	-	2	-	LADN20
	4	-	-	-	-	2	LADN02
		-	-	-	2	2	LADN22 LADN22S ⁽⁴⁾
		-	-	-	1	3	LADN13
		-	-	-	4	-	LADN40
		-	-	-	-	4	LADN04
		-	-	-	3	1	LADN31
	4 incl. 1 N/O & 1 N/C make before break	-	-	-	2	2	LADC22
Side (contact blocks compatible with AC coil contactors only)	2	-	-	-	1	1	LAD8N11
		-	-	-	2	-	LAD8N20
		-	-	-	-	2	LAD8N02

For terminal referencing conforming to EN 50012

Front on 3P contactors and 4P contactors 20 to 80 A	2	-	-	-	1	1	LADN11G
	4	-	-	-	2	2	LADN22G
Front on 4P contactors 125 to 200 A	2	-	-	-	1	1	LADN11P
	4	-	-	-	2	2	LADN22P

With dust and damp protected contacts, for use in particularly harsh industrial environments

Front	2	-	2	-	-	-	LA1DX20
		1	1	-	-	-	LA1DX11
		2	-	-	-	-	LA1DX02
		-	2	2	-	-	LA1DY20 ⁽²⁾
		-	2	-	2	-	LA1DZ40
	4	-	2	-	1	1	LA1DZ31

Instantaneous auxiliary contact blocks for connection by lugs

This type of connection is not possible for blocks with 1 contact or blocks with dust and damp protected contacts. For all other instantaneous auxiliary contact blocks, add the figure 6 to the end of the references selected above. Example: LAD N11 becomes LAD N116.

Instantaneous auxiliary contact blocks for connection by spring terminals

This type of connection is not possible for LAD 8, LAD N with 1 contact or blocks with dust and damp protected contacts. For all other contact blocks, add the figure 3 to the end of the references selected above. Example: LAD N11 becomes LAD N113.

Instantaneous auxiliary contact blocks for connection by Faston connectors

This type of connection is not possible for LAD 8, LAD N with 1 contact or blocks with dust and damp protected contacts. For all other contact blocks, add the figure 9 to the end of the references selected above. Example: LAD N11 becomes LAD N119.

Maximum number of auxiliary contacts that can be fitted:

Contactors	Type	Number of poles and size	Instantaneous auxiliary contacts				Time delay Front mounted	
			Side mounted	Front mounted				
				1 contact	2 contacts	4 contacts		
AC	3P	LC1 D09...D38	1 on LH or 1 on RH side ⁽¹⁾ and	-	1	or 1	or 1	
AC/DC		LC1 D40A...D80A	1 on LH or 1 on RH side and	-	1	or 1	or 1	
		LC1 D80 and D95 (50/60 Hz)	1 on each side or	2	and 1	or 1	or 1	
		LC1 D80 and D95 (50 or 60 Hz)	1 on each side and	2	and 1	or 1	or 1	
		LC1 D115 and D150	1 on LH side and	-	1	or 1	or 1	
		LC1 DT20...DT40	1 on LH side and	-	1	or 1	or 1	
	4P	LC1 DT60A and DT80A	1 on LH or 1 on RH side and	-	1	or 1	or 1	
		LC1 D40008, D65008 and D80	1 on each side or	1	or 1	or 1	or 1	
		LC1 D115	1 on each side and	1	or 1	or 1	or 1	
		DC	3P	LC1 D09...D38	-	1	or 1	or 1
		LC1 D40A...D80A	-	1	or 1	or 1		
LC1 D80 and D95	-	1	or 1	or 1				
LC1 D115 and D150	1 on LH side and	-	1	or 1	or 1			
	4P	LC1 DT20...DT40	-	1	or 1	or 1		
		LC1 DT60A and DT80A	-	1	or 1	or 1		
		LC1 D40008, D65008 and D80	-	2	and 1	or 1	or 1	
		LC1 D115	1 on each side	-	and 1	or 1	or 1	
		LC	3P ⁽³⁾⁽⁵⁾	LC1 D09...D38	-	1	-	-
4P	LC1 DT20...DT40	-	1	-	-			

⁽¹⁾ 1 on LH side for AC coils - 1 on RH side for AC/DC coils. ⁽⁴⁾ With red front face - for safety chain indication.

⁽²⁾ Device fitted with 4 earth screen continuity terminals.

⁽⁵⁾ LA1D●●● dust & damp proof auxiliary contact blocks not allowed.

⁽³⁾ LC: low consumption.

TeSys contactors

TeSys D contactors and reversing contactors

Time delay auxiliary contact blocks Mechanical latch blocks

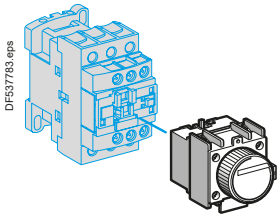

LAD T●

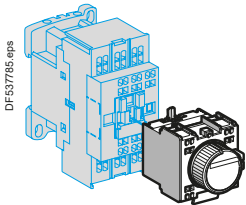

LAD T●3

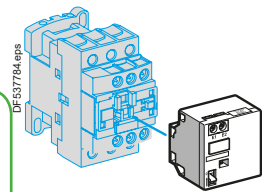

LAD 6K10●

Contactors

Time delay auxiliary contact blocks for connection by screw clamp terminals

Maximum number of auxiliary contact blocks that can be fitted per contactor, see page B8/23.

Sealing cover to be ordered separately, see page B8/29.

LAD T0 and LAD R0: with extended scale from 0.1 to 0.6 s.

LAD S2: with switching time of 40 ms ± 15 ms between opening of the N/C contact and closing of the N/O contact.

Clip-on mounting	Number of contacts	Time delay		Reference
		Type	Setting range	
Front	1 N/O + 1 N/C	On-delay	0.1...3 s	LADT0
			0.1...30 s	LADT2
			10...180 s	LADT4
		Off-delay	1...30 s	LADS2
			0.1...3 s	LADR0
			0.1...30 s	LADR2
		10...180 s	LADR4	

Time delay auxiliary contact blocks for connection by lugs

Add the figure 6 to the end of the references selected above. Example: LAD T0 becomes LAD T06.

Time delay auxiliary contact blocks for connection by spring terminals

Add the figure 3 to the end of the references selected above. Example: LAD T0 becomes LAD T03.

Time delay auxiliary contact blocks for connection by Faston connectors

Add the figure 9 to the end of the references selected above. Example: LAD T0 becomes LAD T09.

Mechanical latch blocks ⁽¹⁾

Clip-on mounting	Unlatching control	For use on contactor	Basic reference, to be completed by adding the control voltage code ⁽²⁾
Front	Manual or electric	LC1 D09...D38 (~ or ---) ⁽³⁾	LAD6K10●
		LC1 DT20...DT40 (~ or ---)	LAD6K10●
		LC1 D40A...D80A (3 P ~ or ---)	LAD6K10●
		LC1 DT60A and DT80A (4 P ~ or ---)	LAD6K10●
		LC1 D80...D150 (3 P ~)	LA6DK20●
		LC1 D80 and D115 (3 P ---) LC1 D80 (4 P ~) LC1 D80 and D115 (4 P ~) LP1 D80 and LC1 D115 (4 P ---)	LA6DK20●

⁽¹⁾ The mechanical latch block must not be powered up at the same time as the contactor. The duration of the control signal for the mechanical latch block and the contactor should be: ≥ 100 ms for a contactor operating on an a.c. supply, ≥ 250 ms for a contactor operating on a d.c. supply.

Maximum impulse duration for the LAD 6K10● mechanical latch block: 10 seconds.

⁽²⁾ Standard control circuit voltages (for other voltages, please consult your Regional Sales Office):

Volts 50/60 Hz, 24	32/36	42/48	60/72	100	110/127	220/240	256/277	380/415	

Code	B	C	E	EN	K	F	M	U	Q

⁽³⁾ The DC, low consumption contactors (coil code ●L) are not compatible with the mechanical latch blocks LAD6K10●.

TeSys contactors

TeSys D contactors and reversing contactors

Suppressor modules

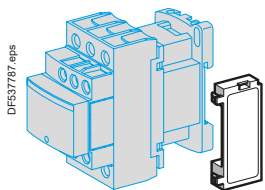

LAD 4••

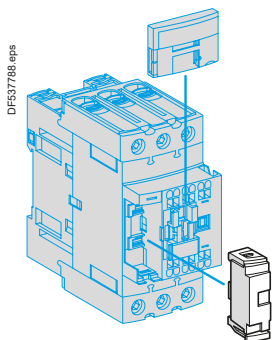

LAD 4RC3•, LAD 4V3•,
LAD 4D3U, LAD 4T3•

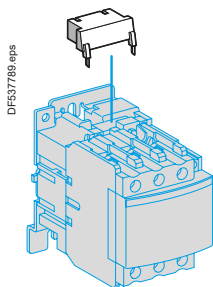

LA4 D••

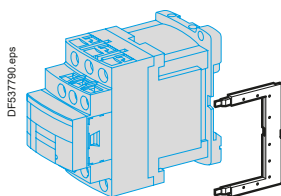

LAD 4DDL or LAD 4T•DL

RC circuits (Resistor-Capacitor)

Effective protection for circuits highly sensitive to "high frequency" interference. For use only in cases where the voltage is virtually sinusoidal. i.e. less than 5 % total harmonic distortion. Voltage limited to 3 Uc max. and oscillating frequency limited to 400 Hz max. Slight increase in drop-out time (1.2 to 2 times the normal time).

Mounting	For use with contactor ⁽¹⁾ Rating	Type		Reference
		V~	V---	
Clip-on side mounting ⁽³⁾⁽⁵⁾	D09...D38 (3P) DT20...DT40	24...48	-	LAD4RCE
		50...127	-	LAD4RCG
		110...250	-	LAD4RCU
Clip-on front mounting ⁽³⁾⁽⁵⁾	D40A...D65A (3P) DT60A...DT80A (4P)	24...48	-	LAD4RC3E
		50...127	-	LAD4RC3G
		110...240	-	LAD4RC3U
		380...415	-	LAD4RC3N
Screw fixing ⁽⁴⁾	D80...D150 (3P) D40...D115 (4P)	24...48	-	LA4DA2E
		50...127	-	LA4DA2G
		110...240	-	LA4DA2U
		380...415	-	LA4DA2N

Varistors (peak limiting)

Protection provided by limiting the transient voltage to 2 Uc max. Maximum reduction of transient voltage peaks. Slight increase in drop-out time (1.1 to 1.5 times the normal time).

Clip-on side mounting ⁽³⁾⁽⁵⁾	D09...D38 (3P) DT20...DT40	24...48	-	LAD4VE
		50...127	-	LAD4VG
		110...250	-	LAD4VU
Clip-on front mounting ⁽³⁾⁽⁵⁾	D40A...D65A (3P) DT60A...DT80A (4P)	24...48	24...48	LAD4V3E
		50...127	50...127	LAD4V3G
		110...250	110...250	LAD4V3U
		24...48	-	LA4DE2E
Screw fixing ⁽⁴⁾	D80...D115 (3P) D80...D115 (4P)	50...127	-	LA4DE2G
		110...250	-	LA4DE2U
Screw fixing ⁽⁴⁾	D80...D95 (3P) D80 (4P)	-	24...48	LA4DE3E
		-	50...127	LA4DE3G
		-	110...250	LA4DE3U

Flywheel diodes

No overvoltage or oscillating frequency. Increase in drop-out time (6 to 10 times the normal time). Polarised component.

Clip-on side mounting ⁽⁵⁾	D09...D38 (3P), DT20...DT40	-	5...600	LAD4DDL
Clip-on front mounting ⁽⁵⁾	D40A...D65A (3P), DT60A...DT80A (4P)	-	24...250	LAD4D3U
Screw fixing ⁽⁴⁾	D80 and D95 (3P), D40...D80 (4P)	-	24...250	LA4DC3U

Bidirectional peak limiting diodes

Protection provided by limiting the transient voltage to 2 Uc max. Maximum reduction of transient voltage peaks.

Clip-on side mounting ⁽³⁾	D09...D38 (3P) DT20...DT40 (4P) ⁽²⁾	24	-	LAD4TB
		-	24	LAD4TBDL
		72	-	LAD4TS
		-	72	LAD4TSDL
		-	125	LAD4TGDL
		-	250	LAD4TUDL
Clip-on front mounting ⁽³⁾	D40A...D65A (3P) DT60A...DT80A (4P) ⁽²⁾	-	600	LAD4TXDL
		12...24	12...24	LAD4T3B
		25...72	25...72	LAD4T3S
		73...125	73...125	LAD4T3G
		126...250	126...250	LAD4T3U
		251...440	251...440	LAD4T3R
Screw fixing ⁽⁴⁾	D80...D95 (3P) D40...D80 (4P)	12...24	-	LA4DB2B
		25...72	-	LA4DB2S
		-	24	LA4DB3B
		-	72	LA4DB3S

(1) For satisfactory protection, a suppressor module must be fitted across the coil of each contactor except for TeSys D Green (••E coil), as surge protection is already embedded.

(2) From D09 to D65A and from LC1 DT20 to DT80A, d.c., low consumption or TeSys D Green 3-pole contactors are fitted with a built-in bidirectional peak limiting diode suppressor as standard. This bidirectional peak limiting diode is removable and can therefore be replaced by the user. (See reference above). If a d.c. or low consumption contactor is used without suppression, the standard suppressor should be replaced with a blanking plug (reference LAD 9DL for LC1 D09 to D38 and LC1 DT20 to DT40; reference LAD 9DL3 for LC1 D40A to D65A and LC1 DT60A to DT80A).

(3) Clipping-on makes the electrical connection. The overall size of the contactor remains unchanged.

(4) Mounting at the top of the contactor on coil terminals A1 and A2.

(5) In order to install these accessories, the existing suppression device must first be removed.

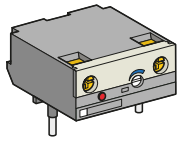

LA4 DT

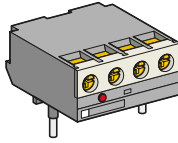

LA4 DFB⁽¹⁾

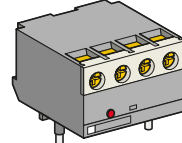

LA4 DWB

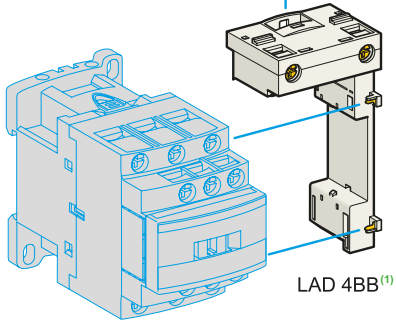

LC1 D09...D38

LAD 4BB⁽¹⁾

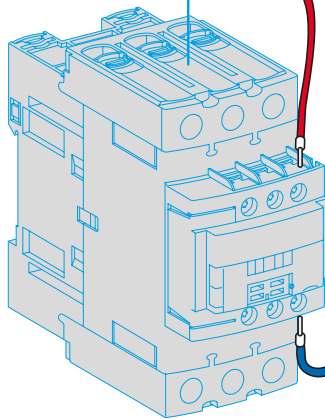

LC1 D40A...D80A

LAD 4BB3

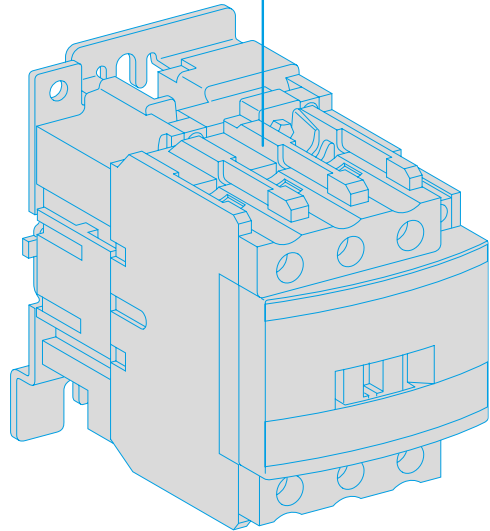

LC1 D80...D95

Contactors

See page opposite for mounting possibilities according to the contactor type.

⁽¹⁾ For TeSys D with AC coil only.

TeSys contactors

TeSys D contactors and reversing contactors

Accessories

Electronic serial timer modules ⁽¹⁾

- 3-pole contactors LC1 D09 to D38: mounted using adapter LAD 4BB, to be ordered separately, see below.
- 3-pole contactors LC1 D40A to D65A: mounted using adapter LAD 4BB3, to be ordered separately, see below.
- 3-pole contactors LC1 D80 to D150 and 4-pole contactors LC1 D40 to D115: mounted directly across terminals A1 and A2 of the contactor.

On-delay type

Operational voltage ~		Time delay	Reference
24...250 V	100...250 V		
LC1 D09...D80A (3P)	LC1 D80...D150 (3P)	0.1...2 s	LA4DT0U
		1.5...30 s	LA4DT2U
		25...500 s	LA4DT4U

Interface modules

- 3-pole contactors LC1 D09 to D38: mounted using adapter LAD 4BB, to be ordered separately, see below.
- 3-pole contactors LC1 D40A to D80A: mounted using adapter LAD4 BB3, to be ordered separately, see below.

Relay interface

Operational voltage ~		Supply voltage E1-E2 (---)	Reference
24...250 V			
LC1 D09...D150 (3P)		24 V	LA4DFB

Static relay interface

Operational voltage ~		Supply voltage E1-E2 (---)	Reference
24...250 V	100...250 V		
LC1 D09...D80A (3P)	LC1 D80...D115 (3P)	24 V	LA4DWB

Adapter kit for low control signal

For use on contactors	Composition	Reference
LC1 D40A...D80A (3P) ⁽²⁾	<ul style="list-style-type: none"> ■ 1 LAD4BB3 coil wiring adapter ■ 1 LA4DFB relay interface module 	LA4DBL

Wiring adapters for coil retrofit of 3 pole contactors

For adapting existing wiring to a new product

For use on contactors		Reference	
LC1 D09...D38	Without coil suppression	LAD4BB ⁽³⁾	
	With coil suppression	~ 24...48 V	LAD4BBVE
		~ 50...127 V	LAD4BBVG
		~ 110...250 V	LAD4BBVU
LC1 D40A...80A	Without coil suppression	LAD4BB3	

⁽¹⁾ For 24 V operation, the contactor must be fitted with a 21 V coil (code Z). See pages B8/32 to B8/35.

⁽²⁾ The kit is compatible with a coil voltage of ~ 24 V to ~ 250 V (B7 to U7) and --- 24 V to --- 250 V (BD to UD).

⁽³⁾ LAD4BB can not be used with 4 poles contactors.

TeSys contactors

TeSys D contactors and reversing contactors

Accessories

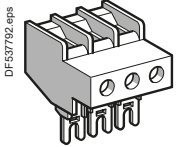

LA9 D3260

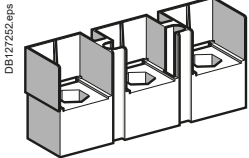

LA9 D11550

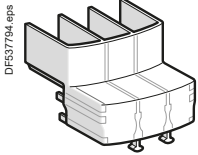

LA9 D11550

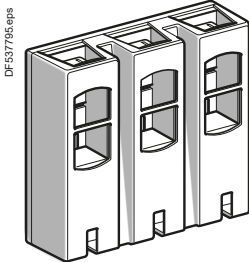

LAD 96570

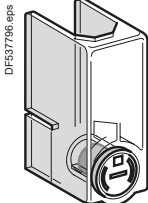

LA9 D11560

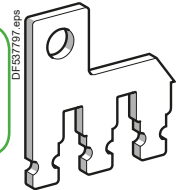

LA9 D80962

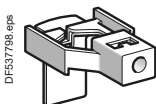

LA9 D11567

Accessories for main pole and control connections

Description	For use with contactors LC1	~	---	Sold in lots of	Unit reference
Connectors for cable, size (1 connector)	4-pole 10 mm ²	DT20, DT25	DT20, DT25	1	LA92560
	3-pole 25 mm ²	D09...D38	D09...D38	1	LA9D3260
EverLink® terminal block	3-pole	D40A...D80A	D40A...D80A	1	LA96560
Connectors for cables (2 connectors)	3-pole 120 mm ²	D115, D150	D115, D150	1	LA9D115603
	4-pole 120 mm ²	D115	D115	1	LA9D115604
Connectors for lug type terminals (2 connectors)	3-pole	D1156, D1506	D1156, D1506	1	LA9D115503
	4-pole	D1156	D1156	1	LA9D115504
Protective covers for connectors for lug type terminals	3-pole	D40A6...D80A6	D40A6...D80A6	1	LA9D96570
		D1156, D1506	D1156, D1506	1	LA9D115703 ⁽¹⁾
	4-pole	D60A6...D80A6	D60A6...D80A6	1	LA9D96580
		D1156, D1506	D1156, D1506	1	LA9D115704
IP 20 covers for lug type terminals (for mounting with circuit breakers GV3 P●●6 and GV3 L●●6)	3 poles	D40A6...D80A6	D40A6...D80A6	1	LA9D96575
Links for parallel connection of	2 poles	D09...D38	D09...D38	10	LA9D2561
		DT20, DT25 (4P)	DT20, DT25 (4P)	10	LA9D1261
		DT32, DT40 (4P)	DT32, DT40 (4P)	10	LA9D96061
		D40A...D80A	D40A...D80A	1	LA9D9P32
		D80, D95	D80, D95	2	LA9D80961
	3 poles	D09...D38	D09...D38	10	LA9D9P3 ⁽²⁾
		D40A...D80A	D40A...D80A	1	LA9D9P33
		D80, D95	D80, D95	1	LA9D80962
	4 poles	DT20, DT25	DT20, DT25	2	LA9D1263
		D80	D80	2	LA9D80963
Staggered coil connection	–	D80	D80	10	LA9D09966
Control circuit take-off from main pole	D80, D95	D80, D95	D80, D95	10	LA9D8067
	D115, D150	D115, D150	D115, D150	10	LA9D11567
Spreaders for increasing the pole pitch to 45 mm	D115, D150	D115, D150	D115, D150	3	GV7AC03

(1) For 3-pole contactors: 1 set of 6 covers, for 4-pole contactors: 1 set of 8 covers.

(2) Separate connecting bar for connecting 2 poles in parallel.

Contactors

TeSys contactors

TeSys D contactors and reversing contactors

Accessories

Sets of contacts and arc chambers

Description	For contactor	Reference	
Sets of contacts	3-pole	LC1 D115	LA5D1158031
		LC1 D150	LA5D150803
Arc chambers	4-pole	LC1 D115004	LA5D115804
		LC1 D115	LA5D11550
	3-pole	LC1 D150	LA5D15050
		LC1 D115004	LA5D115450

Power connection accessories

Terminal block	For supply to one or more GV2 G busbar sets	GV1G09
Set of 63 A busbars for parallelling of contactors	2 contactors LC1 D09...D18 or D25...D38	GV2G245
	4 contactors LC1 D09...D18 or D25...D38	GV2G445
Set of 115 A busbars for parallelling of contactors	2 contactors LC1 D40A...D80A	GV3G264
	3 contactors LC1 D40A...D80A	GV3G364 ⁽¹⁾
Set of S-shape busbars	For circuit breakers GV3 P●● and GV3 L●● ⁽³⁾ and contactors LC1 D40A...D73A	GV3S

Protection accessories

Description	Use	Sold in lots of	Reference
Miniature control circuit fuse holder	5 x 20 with 4 A-250 V fuse	1	LA9D941
Sealing cover	For LAD T, LAD R	1	LA9D901
Safety cover preventing access to the moving contact carrier	LC1 D09...D80A and DT20...DT80A	1	LAD9ET1
	Red cover (for safety chain indication)	1	LAD9ET1S
	LC1 D80 and D95	1	LAD9ET3
	Red cover (for safety chain indication)	1	LAD9ET3S
	LC1 D115 and D150	1	LAD9ET4
	Red cover (for safety chain indication)	1	LAD9ET4S

Marking accessories

Description	Use	Sold in lots of	Unit reference
Sheet of 64 blank legends, self-adhesive, 8 x 33 mm ⁽²⁾	Contactors (except 4P) LC1 D80...D115, LAD N (4 contacts), LA6 DK	10	LAD21
Sheet of 112 blank legends, self-adhesive, 8 x 12 mm ⁽²⁾	LAD N (2 contacts), LAD T, LAD R, LRD	10	LAD22
Sheet of 64 blank legends for marking using plotter or 8 x 33 mm engraver	Contactors (except 4P) LC1 D80...D115, LAD (4 contacts), LA6 DK	10	LAD23
Sheet of 440 blank legends for marking using plotter or 8 x 12 mm engraver	All products	35	LAD24
Marker holder snap-in, 8 x 22 mm	4-pole contactors, LC1 D80...D115, LA6 DK	100	LA9D92
Marker holder snap-in, 8 x 18 mm	LC1 D09...D65A, LC1 DT20...DT80A, LAD N (4 contacts), LAD T, LAD R	100	LAD90
Bag of 300 blank legends self-adhesive, 7 x 21 mm	On holder LA9 D92	1	LA9D93

Mounting accessories

Retrofit plate for screw fixing	For replacement of LC1 D40 to D80 with LC1 D40A to D80A	1	LAD7X3
Mounting plate	For replacement of LC1 F115 or F150 with LC1 D115 or D150	1	LA9D730
Size 4 Allen key, insulated, 1000 V	For use on contactors LC1 D40A to LC1 D150	5	LADALLEN4

⁽¹⁾ With this set of busbars, any one contactor can be supplied directly by its EverLink® double cage power terminal block. The other two contactors are supplied by the busbar set. The 115 A limitation is therefore applied to these two contactors. Example: 1 LC1 D65A supplied directly + 1 contactor LC1 D65A and 1 contactor LC1 D50 A supplied via the busbar set = 115 A. This combination is compatible with busbar set GV3 G364.

⁽²⁾ These legends are for sticking onto the safety cover of the contactors or add-on block, if fitted.

⁽³⁾ With 73 A current limit for GV3L73, GV3P73.

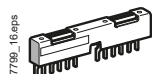

GV2 G245

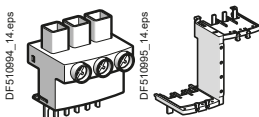

GV1 G09

GV3 S

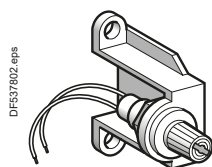

LA9 D941

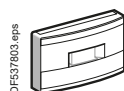

LAD 9ET●

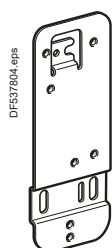

LAD 7X3

TeSys contactors

Component parts for assembling reversing contactors for motor control, low-speed/high-speed starters and star-delta starters

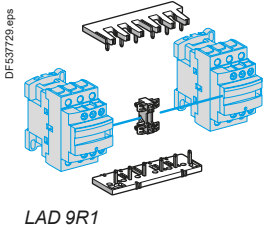

LAD 9R1

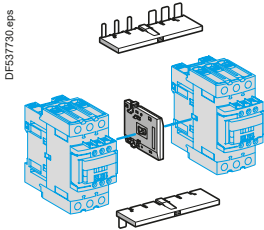

LAD 9R3

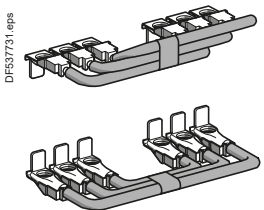

LA9 D8069

For 3-pole reversing contactors for motor control

Contactors with screw clamp terminals or connectors. Horizontally mounted, assembled by customer.

Description	For contactors ⁽¹⁾ (2 identical contactors)	Reference
Kits for assembly of reversing contactors		
Kit comprising: ■ a mechanical interlock LAD 9V2 with electrical interlocking LAD 9V1 ■ a set of power connections LAD 9V5 (parallel) and LAD 9V6 (reversing).	LC1 D09 to D38	LAD9R1V
Kit comprising: ■ a mechanical interlock LAD 9V2 without electrical interlocking ■ a set of power connections LAD 9V5 (parallel) and LAD 9V6 (reversing).	LC1 D09 to D38	LAD9R1
Kit comprising: ■ a mechanical interlock LAD 4CM ■ a set of power connections LA9 D65A69 .	LC1 D40A to D80A	LAD9R3

Mechanical interlocks

Mechanical interlock with integral electrical interlocking	LC1 D80 and D95 (~)	LA9D4002
	LC1 D80 and D95 (∴)	LA9D8002
	LC1 D115 and D150	LA9D11502
Mechanical interlock without integral electrical interlocking	LC1 D09 to D38	LAD9V2
	LC1 D40A to D80A	LAD4CM
	LC1 D80 and D95 (~)	LA9D50978
	LC1 D80 and D95 (∴)	LA9D80978

Sets of power connections

Comprising: ■ a set of parallel bars ■ a set of reverser bars.	LC1 D09 to D38 with screw clamp terminals or connectors	LAD9V5 + LAD9V6
	LC1 D09...D32 with spring terminal connections	LAD9V12 + LAD9V13 ⁽²⁾
	LC1 D40A to D80A	LA9D65A69
	LC1 D80 and D95 (~)	LA9D8069
	LC1 D80 and D95 (∴)	LA9D8069
	LC1 D115 and D150	LA9D11569

For low-speed/high-speed starter

Description	For LC1D09... D38 contactors with connection type	Reference
Connection kit enabling reversing of low and high speed directions using a reversing contactor and a 2N/O + 2N/C main pole contactor	Screw clamps or connectors	LAD9PVG
	Spring terminals	LAD3PVG

For star-delta starter

Description	For contactors	Reference	Without timer LADS2
Mounting kit comprising: ■ 1 time delay contact block LAD S2 (LC1 D09...D80), ■ power circuit connections (LC1 D09...D80), ■ hardware required for fixing the contactors onto the mounting plate (LC1 D80).	LC1 D09 to D38 ⁽³⁾	LAD91217	LAD91218
	LC1 D09 to D38 ⁽⁴⁾	LAD93217	LAD93218
	LC1 D40A to D65A	LAD9SD3	–
	LC1 D80	LA9D8017	–
Equipment mounting plates	LC1 D09 to D38	LA9D12974	
	LC1 D40A and D50A	–	
	LC1 D80	LA9D80973	

(1) To order the 2 contactors: see pages B8/3 and B8/16.

(2) To assemble a reversing contactor with spring terminal connections, the following components must be ordered:

- 1 mechanical interlock **LAD 9V2**,
- 1 upstream power connection kit and 1 downstream power connection kit.

Upstream power connection kit **LAD 9V10**: installed in the Quickfit system with power connection module **LAD 34**.

(If module **LAD 34** is not used, replace **LAD 9V10** with **LAD 9V12**).

Downstream power connection kit **LAD 9V11**: installed in the Quickfit system with outgoing terminal block **LAD 331**.

(If **LAD 331** is not used, replace **LAD 9V11** with **LAD 9V13**).

(3) For assembly of 3 contactors of the same physical size (depth).

(4) For assembly of 3 contactors with star contactor physically smaller (depth).

TeSys contactors

Component parts for assembling changeover contactor pairs

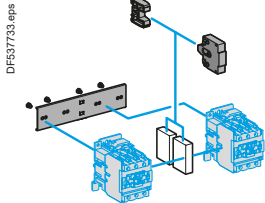

LA9 D50978

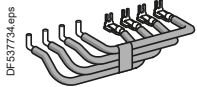

LA9 D6570

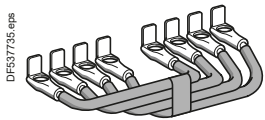

LA9 D8070

For 4-pole changeover contactor pairs (3-phase distribution + neutral)

Contactors with screw clamp terminals or connectors. Horizontally mounted, assembled by customer.

Description	For contactors ⁽¹⁾ (2 identical contactors)	Reference
Kits for assembly of changeover contactor pairs		
Kit comprising: ■ a mechanical interlock LAD 9V2 with electrical interlocking LAD 9V1, ■ a set of power connections (changeover) LAD 9V7.	LC1 DT20 to DT40 with screw clamps or connectors	LADT9R1V
Kit comprising: ■ a mechanical interlock LAD 9V2 without electrical interlocking, ■ a set of power connections (changeover) LAD 9V7.	LC1 DT20 to DT40 with screw clamps or connectors	LADT9R1
Mechanical interlocks		
With integral electrical interlocking	LC1 D80004	LA9D4002
	LP1 D80004	LA9D8002
	LC1 D115004	LA9D11502
Without integral electrical interlocking	LC1 DT20 to DT40 with screw clamps or connectors	LAD9V2 ⁽²⁾
	LC1 DT203 to DT403 with spring terminals	LAD9V2 ⁽²⁾
	LC1 DT60A and DT80A	LAD4CM
	LC1 D80004	LA9D50978
	LP1 D80004	LA9D80978
Sets of power connections		
Comprising a set of parallel bars	LC1 D80004	LA9D8070
	LP1 D80004	LA9D8070
	LC1 D115004	LA9D11570
	LC1 DT203 to DT403 with spring terminals	LAD9V9
	LC1 D80004	LA9D8070 ⁽²⁾
	LP1 D80004	LA9D8070 ⁽²⁾
For 3-pole changeover contactor pairs		
Contactors with screw clamp terminals or connectors. Horizontally mounted, assembled by customer.		
Description	For contactors ⁽¹⁾ (2 identical contactors)	Reference
Kits for assembly of changeover contactor pairs		
Kit comprising: ■ a mechanical interlock LAD4CM ■ a set of parallel bars LA9D65A6	LC1 D40A...D80A	LAD9R3S
Mechanical interlocks		
Without integral electrical interlocking	LC1 D40A...D80A	LAD4CM
With integral electrical interlocking	LC1 D115 and D150	LA9D11502
Sets of power connections		
Comprising a set of parallel bars	LC1 D40A...D80A	LA9D65A6
	LC1 D115 and D150	LA9D11571

⁽¹⁾ To order the 2 contactors: see pages B8/3 and B8/16.

⁽²⁾ Order 2 contact blocks **LAD N•1** to build the electrical interlock, see page B8/23.

TeSys contactors

a.c. coils for TeSys D, 3 or 4-pole contactors

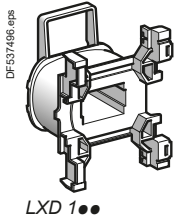

For ~ contactors LC1 D09...D38 and LC1 DT20...DT40

Specifications

Average consumption at 20 °C:

■ inrush ($\cos \phi = 0.75$) 70 VA,■ sealed ($\cos \phi = 0.3$) 50 Hz: 7 VA, 60 Hz: 7.5 VA.Operating range ($\theta \leq 60$ °C): 50 Hz: 0.8...1.1 Uc, 60 Hz: 0.85...1.1 Uc.

Control circuit voltage Uc	Average resistance at 20 °C ± 10 %	Inductance of closed circuit	Reference ⁽¹⁾
V	Ω	H	
12	1.33	0.05	LXD1J7
21 ⁽²⁾	4.17	0.17	LXD1Z7
24	5.37	0.22	LXD1B7
32	10.1	0.39	LXD1C7
36	12.8	0.49	LXD1CC7
42	17	0.67	LXD1D7
48	21.7	0.87	LXD1E7
60	34.6	1.4	LXD1EE7
100	100.4	3.8	LXD1K7
110	124.1	4.6	LXD1F7
115	129.8	5	LXD1FE7
120	150.6	5.4	LXD1G7
127	158.5	6.1	LXD1FC7
200	410.7	15	LXD1L7
208	430.4	16	LXD1LE7
220	515.4	18	LXD1M7 ⁽³⁾
230	538.6	20	LXD1P7
240	562.3	22	LXD1U7
277	800.7	29	LXD1W7
380	1551	55	LXD1Q7 ⁽⁴⁾
400	1633	60	LXD1V7
415	1694	65	LXD1N7
440	1993	73	LXD1R7
480	2398	87	LXD1T7
500	2499	95	LXD1S7
575	3294	125	LXD1SC7
600	3810	136	LXD1X7
660	4656	165	LXD1YC7
690	5020	180	LXD1Y7

⁽¹⁾ The last 2 digits in the reference represent the voltage code.⁽²⁾ Voltage for special coils fitted in contactors with serial timer modules, with 24 V supply.⁽³⁾ Suitable for use on 230 V / 50 Hz. In this case, apply a coefficient of 0.6 to the mechanical durability of the contactor (see page B8/62 and B8/64).⁽⁴⁾ Suitable for use on 400 V / 50 Hz. In this case, apply a coefficient of 0.6 to the mechanical durability of the contactor (see page B8/62 and B8/64).

TeSys contactors

a.c. coils for TeSys D, 3 or 4-pole contactors

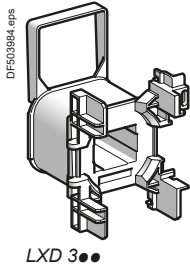

For ~ contactors LC1 D40A...D80A, LC1 DT60A and LC1 DT80A

Specifications

Average consumption at 20 °C:

■ inrush ($\cos \phi = 0.75$) 160 VA,■ sealed ($\cos \phi = 0.3$) 50 Hz: 15 VA, 60 Hz: 15 VA.Operating range ($\theta \leq 60$ °C): 50 Hz: 0.8...1.1 Uc, 60 Hz: 0.85...1.1 Uc.

Control circuit voltage Uc	Average resistance at 20 °C $\pm 10\%$	Inductance of closed circuit	Reference ⁽¹⁾
V	Ω	H	
12	0.49	0.03	50/60 Hz LXD3J5 ⁽²⁾
24	1.98	0.12	LXD3B7
32	3.76	0.22	LXD3C7
42	6.18	0.37	LXD3D7
48	7.97	0.48	LXD3E7
100	37.63	2.07	LXD3K7
110	42.28	2.50	LXD3F7
115	48.76	2.74	LXD3FE7
120	37.63	2.07	LXD3G7 ⁽⁵⁾
127	60.29	3.34	LXD3FC7
200	149	8.27	LXD3L7
208	105	6.22	LXD3LE7 ⁽⁵⁾
220	182	10	LXD3M7 ⁽³⁾
230	192	10.9	LXD3P7
240	202	11.9	LXD3U7
277	193	11	LXD3W7 ⁽⁵⁾
380	512	29.9	LXD3Q7 ⁽⁴⁾
400	607	33.1	LXD3V7
415	635	35.6	LXD3N7
440	682	40.1	LXD3R7
480	607	33.1	LXD3T7 ⁽⁵⁾
500	878	51.7	LXD3S7
575	1238	68.4	LXD3SC7
600	1304	74.5	LXD3X7
660	1593	90.1	LXD3YC7
690	1683	98.5	LXD3Y7

⁽¹⁾ The last 2 digits in the reference represent the voltage code.⁽²⁾ This coil can only be used on 50 Hz.⁽³⁾ Suitable for use on 230 V / 50 Hz. In this case, apply a coefficient of 0.6 to the mechanical durability of the contactor (see page B8/62 and B8/64).⁽⁴⁾ Suitable for use on 400 V / 50 Hz. In this case, apply a coefficient of 0.6 to the mechanical durability of the contactor (see page B8/62 and B8/64).⁽⁵⁾ This coil can only be used on 60 Hz.

TeSys contactors

a.c. coils for TeSys D, 3 or 4-pole contactors

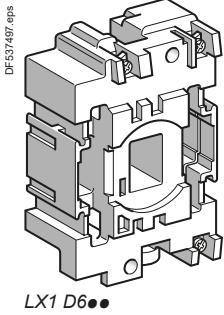

For 3 or 4-pole contactors LC1D40, D50, D65, D80, D95

Specifications

Average consumption at 20 °C:

■ inrush ($\cos \phi = 0.75$) 50 Hz: 200 VA, 60 Hz: 220 VA■ sealed ($\cos \phi = 0.3$) 50 Hz: 20 VA, 60 Hz: 22 VA.Operating range ($\theta \leq 55$ °C): 0.85...1.1 Uc.

Control circuit voltage Uc	Average resistance at 20 °C ± 10 %	Inductance of closed circuit	Reference (1)	Average resistance at 20 °C ± 10 %		Reference (1)
				Ω	H	
			50 Hz			60 Hz
24	1.4	0.09	LX1D6B5	1.05	0.06	LX1D6B6
32	2.6	0.16	LX1D6C5	–	–	–
42	4.4	0.27	LX1D6D5	–	–	–
48	5.5	0.35	LX1D6E5	4.2	0.23	LX1D6E6
110	31	1.9	LX1D6F5	22	1.2	LX1D6F6
115	31	1.9	LX1D6FE5	–	–	–
120	–	–	–	28	1.5	LX1D6G6
127	41	2.4	LX1D6G5	–	–	–
208	–	–	–	86	4.3	LX1D6L6
220	–	–	–	98	4.8	LX1D6M6
220/230	127	7.5	LX1D6M5	–	–	–
230	133	8.1	LX1D6P5	–	–	–
240	152	8.7	LX1D6U5	120	5.7	LX1D6U6
256	166	10	LX1D6W5	–	–	–
277	–	–	–	157	8	LX1D6W6
380	–	–	–	300	14	LX1D6Q6
380/400	381	22	LX1D6Q5	–	–	–
400	411	25	LX1D6V5	–	–	–
415	463	26	LX1D6N5	–	–	–
440	513	30	LX1D6R5	392	19	LX1D6R6
480	–	–	–	480	23	LX1D6T6
500	668	38	LX1D6S5	–	–	–
575	–	–	–	675	33	LX1D6S6
600	–	–	–	775	36	LX1D6X6
660	1220	67	LX1D6Y5	–	–	–

Specifications

Average consumption at 20 °C:

■ inrush ($\cos \phi = 0.75$) 50/60 Hz: 245 VA at 50 Hz■ sealed ($\cos \phi = 0.3$) 50/60 Hz: 26 VA at 50 Hz.Operating range ($\theta \leq 55$ °C): 0.85...1.1 Uc.

				50/60 Hz		
24	–	–	–	1.22	0.08	LX1D6B7
42	–	–	–	3.5	0.25	LX1D6D7
48	–	–	–	5	0.32	LX1D6E7
110	–	–	–	26	1.7	LX1D6F7
115	–	–	–	–	–	LX1D6FE7
120	–	–	–	32	2	LX1D6G7
220/230 (2)	–	–	–	102	6.7	LX1D6M7
230	–	–	–	115	7.7	LX1D6P7
230/240 (3)	–	–	–	131	8.3	LX1D6U7
380/400 (4)	–	–	–	310	20	LX1D6Q7
400	–	–	–	349	23	LX1D6V7
415	–	–	–	390	24	LX1D6N7
440	–	–	–	410	27	LX1D6R7

(1) The last 2 digits in the reference represent the voltage code.

(2) For use on 230 V / 50 Hz, apply a coefficient of 0.6 to the mechanical durability of the contactor, see page B8/62 and B8/64. This coil can be used on 240 V at 60 Hz.

(3) This coil can be used on 220/240 V at 50 Hz and on 240 V only at 60 Hz.

(4) For use on 400 V / 50 Hz, apply a coefficient of 0.6 to the mechanical durability of the contactor, see page B8/62 and B8/64.

TeSys contactors

a.c. coils for TeSys D, 3 or 4-pole contactors

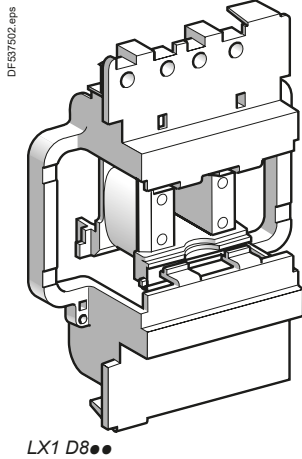

For 3 or 4-pole contactors LC1 D115

Specifications

Average consumption at 20 °C:

■ inrush ($\cos \phi = 0.8$) 50 or 60 Hz: 300 VA■ sealed ($\cos \phi = 0.3$) 50 or 60 Hz: 22 VA.Operating range ($\theta \leq 55$ °C): 0.85...1.1 Uc.

Control circuit voltage Uc	Average resistance at 20 °C ± 10 %	Inductance of closed circuit	Reference (1)	Average resistance at 20 °C ± 10 %	Inductance of closed circuit	Reference (1)
V	Ω	H		Ω	H	
			50 Hz	60 Hz		
24	1.24	0.09	LX1D8B5	0.87	0.07	LX1D8B6
32	2.14	0.17	LX1D8C5	–	–	–
42	3.91	0.28	LX1D8D5	–	–	–
48	4.51	0.36	LX1D8E5	3.91	0.28	LX1D8E6
110	26.53	2.00	LX1D8F5	19.97	1.45	LX1D8F6
115	26.53	2.00	LX1D8FE5	–	–	–
120	–	–	–	24.02	1.70	LX1D8G6
127	32.75	2.44	LX1D8FC5	–	–	–
208	–	–	–	67.92	5.06	LX1D8L6
220	104.77	7.65	LX1D8M5	79.61	5.69	LX1D8M6
230	104.77	8.29	LX1D8P5	–	–	–
240	125.25	8.89	LX1D8U5	97.04	6.75	LX1D8U6
277	–	–	–	125.75	8.89	LX1D8W6
380	338.51	22.26	LX1D8Q5	243.07	17.04	LX1D8Q6
400	368.43	25.55	LX1D8V5	–	–	–
415	368.43	27.65	LX1D8N5	–	–	–
440	441.56	30.34	LX1D8R5	338.51	22.26	LX1D8R6
480	–	–	–	368.43	25.55	LX1D8T6
500	566.62	38.12	LX1D8S5	–	–	–

For 3 or 4-pole contactors LC1 D115, LC1 D150

Specifications

Average consumption at 20 °C:

■ inrush: $\cos \phi = 0.9$ - 280 to 350 VA■ sealed: $\cos \phi = 0.9$ - 2 to 18 VA.Operating range ($\theta \leq 55$ °C): 0.8...1.15 Uc.

Coils with integral suppression device fitted as standard, class B.

Control circuit voltage Uc	Average resistance at 20 °C ± 10 %	Inductance of closed circuit	Reference (1)	Average resistance at 20 °C ± 10 %	Inductance of closed circuit	Reference (1)
V	Ω	H		Ω	H	
50/60 Hz						
24	–	–	–	147	3.03	LX1D8B7
32	–	–	–	301	8.28	LX1D8C7
42	–	–	–	498	13.32	LX1D8D7
48	–	–	–	1061	24.19	LX1D8E7
110	–	–	–	4377	109.69	LX1D8F7
115	–	–	–	4377	109.69	LX1D8FE7
120	–	–	–	4377	109.69	LX1D8G7
127	–	–	–	6586	152.65	LX1D8FC7
208	–	–	–	10 895	260.15	LX1D8LE7
220	–	–	–	9895	210.72	LX1D8M7
230	–	–	–	9895	210.72	LX1D8P7
240	–	–	–	9895	210.72	LX1D8U7
277	–	–	–	21 988	533.17	LX1D8UE7
380	–	–	–	21 011	482.42	LX1D8Q7
400	–	–	–	21 011	482.42	LX1D8V7
415	–	–	–	21 011	482.42	LX1D8N7
440	–	–	–	21 501	507.47	LX1D8R7
480	–	–	–	32 249	938.41	LX1D8T7
500	–	–	–	32 249	938.41	LX1D8S7

(1) The last 2 digits in the reference represent the voltage code.

TeSys contactors

d.c. coils for TeSys D, 3 or 4-pole contactors

For 3-pole contactors LC1 D80 or 4-pole contactors LP1 D80

Specifications

Average consumption: 22 W.

Operating range: 0.85...1.1 Uc.

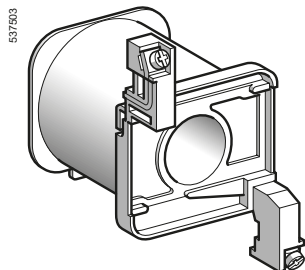

LX4 D7●D

Control circuit voltage Uc	Average resistance at 20 °C ± 10%	Inductance of closed circuit	Reference ⁽¹⁾	Weight
V	Ω	H		kg
12	6.6	0.46	LX4D7JD	0.680
24	27	1.89	LX4D7BD	0.680
36	57	4	LX4D7CD	0.680
48	107	7.5	LX4D7ED	0.680
60	170	11.9	LX4D7ND	0.680
72	230	16.1	LX4D7SD	0.680
110	564	39.5	LX4D7FD	0.680
125	718	50.3	LX4D7GD	0.680
220	2215	155	LX4D7MD	0.680
250	2850	200	LX4D7UD	0.680
440	9195	640	LX4D7RD	0.680

⁽¹⁾ The last 2 digits in the reference represent the voltage code.

TeSys contactors

d.c. coils for TeSys D, 3 or 4-pole contactors

For contactors LC1 D115, D150

Specifications

Consumption: inrush 270 to 365 W, sealed 2.4 to 5.1 W.

Operating range: 0.75...1.2 Uc.

Coils with integral suppression device fitted as standard, class B.

Control circuit voltage Uc	Average resistance at 20 °C ± 10 %	Inductance of closed circuit	Reference ⁽¹⁾	Weight
V	Ω	H		kg
24	147	3.03	LX4D8BD	0.300
48	1061	24.19	LX4D8ED	0.300
60	1673	38.44	LX4D8ND	0.300
72	2500	56.27	LX4D8SD	0.300
110	4377	109.69	LX4D8FD	0.300
125	6586	152.65	LX4D8GD	0.300
220	9895	210.72	LX4D8MD	0.300
250	18 022	345.40	LX4D8UD	0.300
440	21 501	684.66	LX4D8RD	0.300

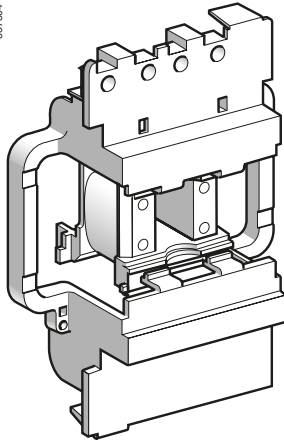

LX4 D8•D

For 3-pole contactors LC1 D80 or 4-pole contactors LP1 D80

Specifications

Wide range coils for specific applications

Average consumption: 23 W.

Operating range: 0.75 to 1.2 Uc.

Coils with "TH" treatment as standard.

Control circuit voltage Uc	Average resistance at 20 °C ± 10 %	Inductance of closed circuit	Reference ⁽¹⁾	Weight
V	Ω	H		kg
12	6.2	0.49	LX4D7JW	0.680
24	23.5	1.75	LX4D7BW	0.680
36	51.9	4.18	LX4D7CW	0.680
48	94.2	7	LX4D7EW	0.680
72	204	15.7	LX4D7SW	0.680
110	483	36	LX4D7FW	0.680
220	1922	144	LX4D7MW	0.680

⁽¹⁾ The last 2 digits in the reference represent the voltage code.

TeSys contactors

Mini-contactors TeSys LC1 SK and LP1 SK



LC1 SK06



LA1 SK10

- Width of contactor 27 mm.
- Mounting on 35 mm rail.
- Screw clamp terminals.

Mini-contactors for motor in category AC-3

Standard power ratings of 3-phase motors 50/60 Hz in category AC-3 ⁽¹⁾				Rated operational voltage in AC-3 up to 400 V	Number of poles	Instantaneous auxiliary contacts	Basic reference. Complete with code indicating control circuit voltage ⁽²⁾	
220 V	380 V	660 V	230 V					
1.1 kW	2.2 kW	2.2 kW	6 kW	6	2	-	-	LC1SK0600●●

Mini-contactors for motor in category AC-1

Non inductive loads maximum current (θ ≤ 55 °C) utilisation category AC-1	Control circuit supply	Number of poles	Instantaneous auxiliary contacts	Basic reference. Complete with code indicating control circuit voltage ⁽²⁾	
					A
12	a.c.	2	-	-	LC1SK0600●●
	d.c.	2	-	-	LP1SK0600●●

Add-on block with 1 power pole (for 3-phase circuits)

For use on contactor	Number of poles	Instantaneous auxiliary contacts	Reference	
LC1 SK06 clip-on front mounting	1	1	-	LA1SK10
	1	-	1	LA1SK01

Note: Auxiliary contact blocks and coil suppressor module, see next page.

(1) For use in AC-3 category and 3-phase circuits, an **LA1 SK●●** auxiliary contact block should be ordered separately for mounting on the contactor.

(2) Standard control circuit voltages (variable delivery times, please consult your Regional Sales Office):

Mini-contactors LC1 SK									
Volts ~ 50/60 Hz	24	48	110	120	220	230	240	380	400
Code	B7	E7	F7	G7	M7	P7	U7	Q7	V7
Mini-contactors LP1 SK									
Volts ⋯	12	24	36	48	72				
Code	JD	BD	CD	ED	SD				

References - TeSys SK

TeSys contactors

Mini-contactors TeSys LC1 SK and LP1 SK

Instantaneous auxiliary contacts and coil suppressor modules

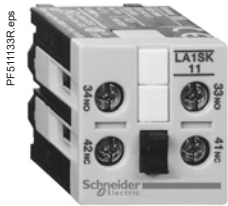

LA1 SK11



LA4 SK1

Instantaneous auxiliary contact blocks

Clip-on front mounting				
For use on contactor	Maximum number of blocks per contactor	Composition		Reference
LC1 SK06	1	2	–	LA1SK20
			–	2
		1	1	LA1SK11

Coil suppressor modules

Clip-on fixing and electrical connection on right-hand side, without use of tools				
For use on contactors	Type	For voltages	Sold in lots of	Unit reference
LC1 SK06 and LP1 SK06	Varistor ⁽¹⁾	~ and ~~~ 24 V...48 V	10	LA4SKE1E
		~ and ~~~ 110 V...250 V	10	LA4SKE1U
	Diode ⁽²⁾	~ 24 V...250 V	10	LA4SKC1U

⁽¹⁾ Protection provided by limiting the transient voltage to 2 U_c max. Maximum reduction of transient voltage peaks. Slight increase in drop-out time (1.1 to 1.5 times the normal time).

⁽²⁾ No overvoltage or oscillating frequency. Slight increase in drop-out time (1.1 to 1.5 times the normal time).

TeSys contactors

Contactors for motor control, 6 to 16 A in category AC-3 and 6 to 12 A in category AC-4

Control circuit: a.c.

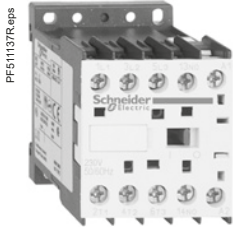

LC1 K0910●●



LC1 K09103●●

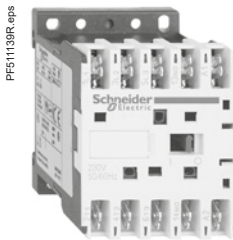

LC1 K09107●●

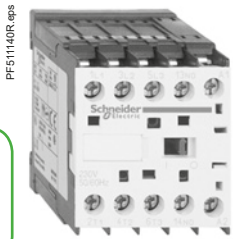

LC1 K09105●●



LC7 K0910●●

Contactors selection according to utilisation category, see pages A6/25 to A6/29 and A6/32 to A6/35.
 Mounting on 35 mm rail or Ø4 screw fixing.
 Screws in the open "ready-to-tighten" position.
 Add-on auxiliary contact blocks and accessories, see pages B8/49 to B8/51.

3-pole contactors for standard applications

Standard power ratings of 3-phase motors 50-60 Hz in category AC-3			Rated operational current in category AC-3 440 V up to	Instantaneous auxiliary contacts	Basic reference, to be completed by adding the voltage code (1)(2)
220 V	380 V	440/500 V			
230 V	415 V	660/690 V			
kW	kW	kW	A		

Screw clamp connections

1.5	2.2	3	6	1	-	LC1K0610●●
				-	1	LC1K0601●●
2.2	4	4	9	1	-	LC1K0910●●
				-	1	LC1K0901●●
3	5.5	4 (> 440)	12	1	-	LC1K1210●●
		5.5 (440)		-	1	LC1K1201●●
4	7.5	4 (> 440)	16	1	-	LC1K1610●●
		5.5 (440)		-	1	LC1K1601●●

Spring terminal connections (3)

For 6 to 12 A ratings only, in the references selected above, insert a figure 3 before the voltage code.
 Example: LC1 K0610●● becomes LC1 K06103●●.

Faston connectors, 1 x 6.35 or 2 x 2.8

For 6 to 16 A ratings, in the references selected above, insert a figure 7 before the voltage code.
 Example: LC1 K0610●● becomes LC1 K06107●●.

Solder pins for printed circuit boards

For 6 to 16 A ratings, in the references selected above, insert a figure 5 before the voltage code.
 Example: LC1 K0610●● becomes LC1 K06105●●.

3-pole silent contactors

Recommended for use in areas sensitive to noise, high interference mains supplies, etc.
 Coil with rectifier incorporated, suppressor fitted as standard.

Screw clamp connections

1.5	2.2	3	6	1	-	LC7K0610●●
				-	1	LC7K0601●●
2.2	4	4	9	1	-	LC7K0910●●
				-	1	LC7K0901●●
3	5.5	4 (> 440)	12	1	-	LC7K1210●●
		5.5 (440)		-	1	LC7K1201●●

Faston connectors, 1 x 6.35 or 2 x 2.8

In the references selected above, insert a figure 7 before the voltage code.
 Example: LC7 K0610●● becomes LC7 K06107●●.

Solder pins for printed circuit boards

In the references selected above, insert a figure 5 before the voltage code.
 Example: LC7 K0610●● becomes LC7 K06105●●.

(1) Standard control circuit voltages (for other voltages, please consult your Regional Sales Office):

a.c. supply (4)

Contactors LC1 K (0.8...1.15 Uc) (0.85...1.1 Uc)

Volts	12	20	24 (2)	36	42	48	110	115	120	127	200/208	220/230	230	230/240
50 Hz (5)			B5		D5	E5							P5	
50/60 Hz	J7	Z7	B7	C7	D7	E7	F7	FE7	G7	FC7	L7	M7	P7	U7
Volts	256	277	380/400	400	400/415	440	480	500	575	600	660/690			
50/60 Hz	W7	UE7	Q7	-	V7	N7	R7	T7	S7	SC7	X7	Y7	-	-

Up to and including 240 V, coil with integral suppression device available: add 2 to the code required. Example: J72.

Contactors LC7 K (0.85...1.1 Uc)

Volts	24	42	48	110	115	220	230/240
50/60 Hz	B7	D7	E7	F7	FE7	M7	U7

(2) For mains supplies with a high level of interference (voltage surge > 800 V), use a suppressor module LA4 KE1FC (50...129 V) or LA4 KE1UG (130...250 V), see page B8/50.

(3) For LC●K●●●●3 / LP●K●●●●3 with spring terminal, Ith max = 10 A.

(4) (0.8...1.15 Uc) for single voltage coil; (0.85...1.1 Uc) for dual voltage coil, exemple 200/208 V AC.

(5) Only available for 'screw clamp terminals' versions.

TeSys contactors

Contactors for motor control, 6 to 12 A in categories AC-3 and AC-4

Control circuit: d.c. or low consumption

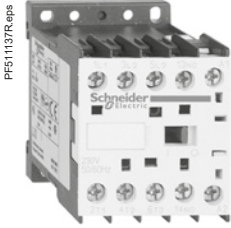

LP1 K0910●●

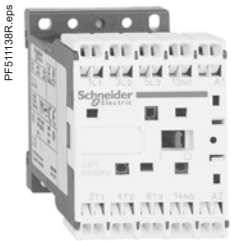

LP1 K09103●●

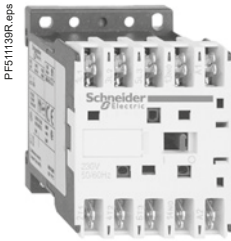

LP1 K09107●●



LP1 K09105●●



LP4 K0910●●

Contactor selection according to utilisation category, see pages A6/25 to A6/29 and A6/32 to A6/35.

Mounting on 35 mm rail or Ø4 screw fixing.

Screws in the open "ready-to-tighten" position.

Add-on auxiliary contact blocks and accessories, see pages B8/49 to B8/51.

3-pole contactors, d.c. supply

Standard power ratings of 3-phase motors 50-60 Hz in category AC-3			Rated operational current in category AC-3 440 V up to	Instantaneous auxiliary contacts 	Basic reference, to be completed by adding the voltage code (1) (2)
220 V	380 V	440/500 V			
230 V	415 V	660/690 V			
kW	kW	kW	A		
Screw clamp connections					
1.5	2.2	3	6	1 -	LP1K0610●●
				- 1	LP1K0601●●
2.2	4	4	9	1 -	LP1K0910●●
				- 1	LP1K0901●●
3	5.5	4 (> 440)	12	1 -	LP1K1210●●
		5.5 (440)		- 1	LP1K1201●●

Spring terminal connections (3)

In the references selected above, insert a figure 3 before the voltage code.

Example: LP1 K0610●● becomes LP1 K06103●●.

Faston connectors, 1 x 6.35 or 2 x 2.8

In the references selected above, insert a figure 7 before the voltage code.

Example: LP1 K0610●● becomes LP1 K06107●●.

Solder pins for printed circuit boards

In the references selected above, insert a figure 5 before the voltage code.

Example: LP1 K0610●● becomes LP1 K06105●●.

3-pole low consumption contactors

Compatible with programmable controller outputs.

Wide range coil (0.7...1.30 Uc), suppressor fitted as standard, consumption 1.8 W.

Screw clamp connections

1.5	2.2	3	6	1 -	LP4K0610●●
				- 1	LP4K0601●●
2.2	4	4	9	1 -	LP4K0910●●
				- 1	LP4K0901●●
3	5.5	4 (> 440)	12	1 -	LP4K1210●●
		5.5 (440)		- 1	LP4K1201●●

Spring terminal connections

In the references selected above, insert a figure 3 before the voltage code.

Example: LP4 K0610●● becomes LP4 K06103●●.

Faston connectors, 1 x 6.35 or 2 x 2.8

In the references selected above, insert a figure 7 before the voltage code.

Example: LP4 K0610●● becomes LP4 K06107●●.

Solder pins for printed circuit boards

In the references selected above, insert a figure 5 before the voltage code.

Example: LP4 K0610●● becomes LP4 K06105●●.

(1) Standard control circuit voltages (for other voltages, please consult your Regional Sales Office):

d.c. supply (contactors LP1 K: 0.8...1.15 Uc)

Volts	12	20	24 (2)	36	48	60	72	100	110	125	155	174	200	220	230	240	250
Code	JD	ZD	BD	CD	ED	ND	SD	KD	FD	GD	PD	QD	LD	MD	MPD	MUD	UD

Coil with integral suppression device available: add 3 to the code required. Example: JD3

Low consumption (contactors LP4 K: 0.7...1.3 Uc)

Volts	12	20	24	48	72	110	120
Code	JW3	ZW3	BW3	EW3	SW3	FW3	GW3

Coil with integral suppression device fitted as standard, by bi-directional peak limiting diode.

(2) For LP1 K only, when connecting an electronic sensor or timer in series with the contactor coil, select a 20 V coil (~ control circuit voltage code Z7, ≡ control circuit voltage code ZD) so as to compensate for the incurred voltage drop.

(3) For LC●K●●●●3 / LP●K●●●●3 with spring terminal, I_{th} max = 10 A.

TeSys contactors

Contactors for control in category AC-1, 20 A

Control circuit: a.c.

Contactor selection according to utilisation category, see pages A6/30 and A6/31.

Mounting on 35 mm rail or Ø4 screw fixing.

Screws in the open "ready-to-tighten" position.

Add-on auxiliary contact blocks and accessories, see pages B8/49 to B8/51.

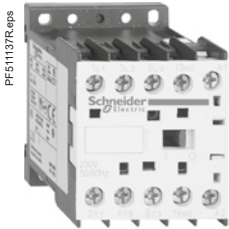

LC1 K09004

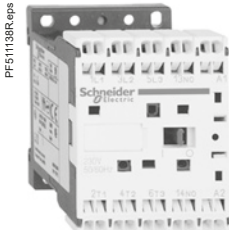

LC1 K09103

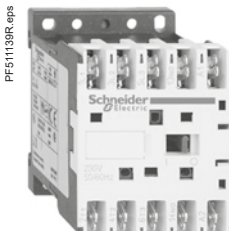

LC1 K09107

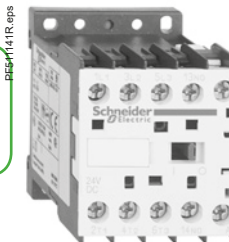

LC1 K09004

Contactors

3 or 4-pole contactors for standard applications ⁽¹⁾

Non-inductive loads Category AC-1 Maximum current at $\theta \leq 50^\circ\text{C}$	Number of poles	Instantaneous auxiliary contacts	Basic reference, to be completed by adding the voltage code ^{(2) (3)}

A

Screw clamp connections

20	3	-	1	-	LC1K0910
					or LC1K1210
	3	-	-	1	LC1K0901
					or LC1K1201
	4	-	-	-	LC1K09004
					or LC1K12004
	2	2	-	-	LC1K09008

Spring terminal connections ⁽⁴⁾

In the references selected above, insert a figure 3 before the voltage code.

Example: LC1 K0910 becomes LC1 K09103.

Faston connectors, 1 x 6.35 or 2 x 2.8

In the references selected above, insert a figure 7 before the voltage code.

Example: LC1 K0910 becomes LC1 K09107.

Solder pins for printed circuit boards

In the references selected above, insert a figure 5 before the voltage code.

Example: LC1 K0910 becomes LC1 K09105.

3 or 4-pole silent contactors ⁽¹⁾

Recommended for use in areas sensitive to noise, high interference mains supplies, etc.

Coil with rectifier incorporated, suppressor fitted as standard.

Screw clamp connections

20	3	-	1	-	LC7K0910
					or LC7K1210
	3	-	-	1	LC7K0901
					or LC7K1201
	4	-	-	-	LC7K09004
					or LC7K12004
	2	2	-	-	LC7K09008

Faston connectors, 1 x 6.35 or 2 x 2.8

In the references selected above, insert a figure 7 before the voltage code.

Example: LC7 K0910 becomes LC7 K09107.

Solder pins for printed circuit boards

In the references selected above, insert a figure 5 before the voltage code.

Example: LC7 K0910 becomes LC7 K09105.

⁽¹⁾ Selection between 9 and 12 A ratings according to number of operating cycles, see AC-1 curve on page A6/30.

⁽²⁾ Standard control circuit voltages (for other voltages, please consult your Regional Sales Office):

a.c. supply ⁽⁵⁾

Contactors LC1 K (0.8...1.15 Uc) (0.85...1.1 Uc)

Volts	12	20	24 ⁽³⁾	36	42	48	110	115	120	127	200/208	220/230	230	230/240
50 Hz ⁽⁶⁾			B5		D5	E5							P5	
50/60 Hz	J7	Z7	B7	C7	D7	E7	F7	FE7	G7	FC7	L7	M7	P7	U7
Volts	256	277	380/400		400	400/415	440	480	500	575	600	660/690		
50/60 Hz	W7	UE7	Q7		V7	N7	R7	T7	S7	SC7	X7	Y7		

Up to and including 240 V, coil with integral suppression device available: add 2 to the code required. Example: J72.

Contactors LC7 K (0.8...1.1 Uc)

Volts	24	42	48	110	115	220	230/240
50/60 Hz	B7	D7	E7	F7	FE7	M7	U7

⁽³⁾ For mains supplies with a high level of interference (voltage surge > 800 V), use a suppressor module LA4 KE1FC (50...129 V) or LA4 KE1UG (130...250 V), see page B8/50.

⁽⁴⁾ For LC●K●●●●●3 / LP●K●●●●●3 with spring terminal, lth max = 10 A.

⁽⁵⁾ (0.8...1.15 Uc) for single voltage coil; (0.85...1.1 Uc) for dual voltage coil, exemple 200/208 V AC.

⁽⁶⁾ Only available for 'screw clamp terminals' versions.

TeSys contactors

Contactors for control in category AC-1, 20 A

Control circuit: d.c. or low consumption

Contactor selection according to utilisation category, see pages A6/30 and A6/31.

Mounting on 35 mm rail or Ø4 screw fixing.

Screws in the open "ready-to-tighten" position.

Add-on auxiliary contact blocks and accessories, see pages B8/49 to B8/51.

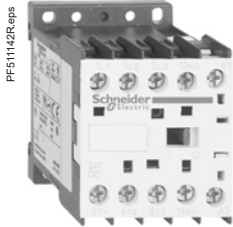

LC1 K09004●●



LC1 K09103●●

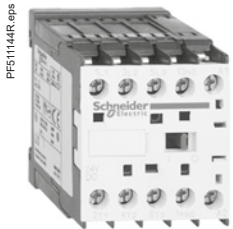

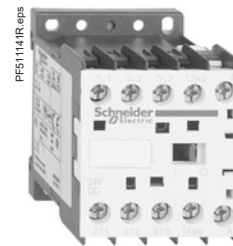

LC1 K09105●●



LC1 K09004●●

3 and 4-pole contactors, d.c. supply ⁽¹⁾

Non-inductive loads Category AC-1 Maximum current at $\theta \leq 50^\circ\text{C}$	Number of poles 	Instantaneous auxiliary contacts 	Basic reference, to be completed by adding the voltage code ⁽²⁾⁽³⁾
--	---	--	---

A

Screw clamp connections

20	3	-	1	-	LP1K0910●● or LP1K1210●●
	3	-	-	1	LP1K0901●● or LP1K1201●●
	4	-	-	-	LP1K09004●● or LP1K12004●●
	2	2	-	-	LP1K09008●●

Spring terminal connections ⁽⁴⁾

In the references selected above, insert a figure 3 before the voltage code.

Example: LP1 K0910●● becomes LP1 K09103●●.

Faston connectors, 1 x 6.35 or 2 x 2.8

In the references selected above, insert a figure 7 before the voltage code.

Example: LP1 K0910●● becomes LP1 K09107●●.

Solder pins for printed circuit boards

In the references selected above, insert a figure 5 before the voltage code.

Example: LP1 K0910●● becomes LP1 K09105●●.

3 or 4-pole low consumption contactors ⁽¹⁾

Compatible with programmable controller outputs.

Wide range coil (0.7...1.30 Uc), suppressor fitted as standard, consumption 1.8 W.

Screw clamp connections

20	3	-	1	-	LP4K0910●●● or LP4K1210●●●
	3	-	-	1	LP4K0901●●● or LP4K1201●●●
	4	-	-	-	LP4K09004●●● or LP4K12004●●●
	2	2	-	-	LP4K09008●●●

Spring terminal connections

In the references selected above, insert a figure 3 before the voltage code.

Example: LP4 K0910●● becomes LP4 K09103●●.

Faston connectors, 1 x 6.35 or 2 x 2.8

In the references selected above, insert a figure 7 before the voltage code.

Example: LP4 K0910●● becomes LP4 K09107●●.

Solder pins for printed circuit boards

In the references selected above, insert a figure 5 before the voltage code.

Example: LP4 K0910●● becomes LP4 K09105●●.

⁽¹⁾ Selection between 9 and 12 A ratings according to number of operating cycles, see AC-1 curve on page A6/30.

⁽²⁾ Standard control circuit voltages (for other voltages, please consult your Regional Sales Office):

d.c. supply (contactors LP1 K: 0.8...1.15 Uc)

Volts ∴	12	20	24 ⁽³⁾	36	48	60	72	100	110	125	155	174	200	220	230	240	250
Code	JD	ZD	BD	CD	ED	ND	SD	KD	FD	GD	PD	QD	LD	MD	MPD	MUD	UD

Coil with integral suppression device available: add 3 to the code required. Example: JD3.

Low consumption (contactors LP4 K: 0.7...1.3 Uc)

Volts ∴	12	20	24	48	72	110	120
Code	JW3	ZW3	BW3	EW3	SW3	FW3	GW3

Coil with integral suppression device fitted as standard, by bi-directional peak limiting diode.

⁽³⁾ For LP1 K only, when connecting an electronic sensor or timer in series with the contactor coil, select a 20 V coil (~ control circuit voltage code Z7, ∴ control circuit voltage code ZD) so as to compensate for the incurred voltage drop.

⁽⁴⁾ For LC●K●●●●3 / LP●K●●●●3 with spring terminal, I_{th} max = 10 A.

TeSys contactors

Reversing contactors for motor control, 6 to 16 A in category AC-3 and 6 to 12 A in category AC-4

Control circuit: a.c.

Reversing contactor selection according to utilisation category, see pages A6/25 to A6/29 and A6/32 to A6/35. Integral mechanical interlock.

It is essential to link the contacts of the electrical interlock.

Pre-wired power circuit connections as standard on screw clamp versions.

Mounting on 35 mm rail or Ø4 screw fixing. Screws in the open "ready-to-tighten" position.

Add-on auxiliary contact blocks and accessories, see pages B8/49 to B8/51.

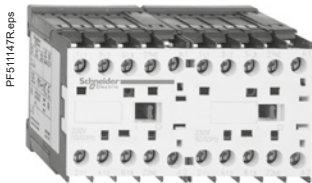

LC2 K0910●●

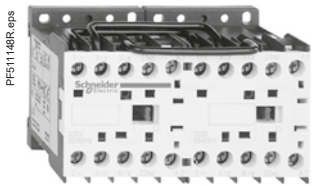

LC2 K09105●●

3-pole reversing contactors for standard applications

Standard power ratings of 3-phase motors 50/60 Hz in category AC-3			Rated operational current in category AC-3 440 V up to	Instantaneous auxiliary contacts per contactor	Basic reference, to be completed by adding the voltage code ⁽¹⁾⁽²⁾
220 V 230 V	380 V 415 V	440/500 V 660/690 V			
kW	kW	kW	A		
Screw clamp connections					
1.5	2.2	3	6	1 -	LC2K0610●●
				- 1	LC2K0601●●
2.2	4	4	9	1 -	LC2K0910●●
				- 1	LC2K0901●●
3	5.5	4 (> 440) 5.5 (440)	12	1 -	LC2K1210●●
				- 1	LC2K1201●●
4	7.5	4 (> 440) 5.5 (440)	16	1 -	LC2K1610●●
				- 1	LC2K1601●●

Spring terminal connections ⁽³⁾

For 6 to 12 A ratings only, in the references selected above, insert a figure 3 before the voltage code. Example: LC2 K0610●● becomes LC2 K06103●●.

Faston connectors, 1 x 6.35 or 2 x 2.8

For 6 to 16 A ratings, in the references selected above, insert a figure 7 before the voltage code. Example: LC2 K0610●● becomes LC2 K06107●●.

Solder pins for printed circuit boards

For 6 to 16 A ratings, in the references selected above, insert a figure 5 before the voltage code. Example: LC2 K0610●● becomes LC2 K06105●●.

3-pole silent reversing contactors

Recommended for use in areas sensitive to noise, high interference mains supplies, etc. Coil with rectifier incorporated, suppressor fitted as standard.

Screw clamp connections

1.5	2.2	3	6	1 -	LC8K0610●●
				- 1	LC8K0601●●
2.2	4	4	9	1 -	LC8K0910●●
				- 1	LC8K0901●●
3	5.5	4 (> 440) 5.5 (440)	12	1 -	LC8K1210●●
				- 1	LC8K1201●●

Faston connectors, 1 x 6.35 or 2 x 2.8

In the references selected above, insert a figure 7 before the voltage code. Example: LC8 K0610●● becomes LC8 K06107●●.

Solder pins for printed circuit boards

In the references selected above, insert a figure 5 before the voltage code. Example: LC8 K0610●● becomes LC8 K06105●●.

⁽¹⁾ Standard control circuit voltages (for other voltages, please consult your Regional Sales Office):

a.c. supply ⁽⁴⁾

Reversing contactors LC2 K (0.8...1.15 Uc) (0.85...1.1 Uc)

Volts	12	20	24 ⁽²⁾	36	42	48	110	115	120	127	200/208	220/230	230	230/240
50/60 Hz	J7	Z7	B7	C7	D7	E7	F7	FE7	G7	FC7	L7	M7	P7	U7
Volts	256	277	380/400	400	400/415	440	480	500	575	600	660/690			
50/60 Hz	W7	UE7	Q7	V7	N7	R7	T7	S7	SC7	X7	Y7			

Up to and including 240 V, coil with integral suppression device available: add 2 to the code required. Example: J72.

Reversing contactors LC8 K (0.8...1.1 Uc)

Volts	24	42	48	110	115	220	230/240
50/60 Hz	B7	D7	E7	F7	FE7	M7	U7

⁽²⁾ For mains supplies with a high level of interference (voltage surge > 800 V), use a suppressor module LA4 KE1FC (50...129 V) or LA4 KE1UG (130...250 V), see page B8/50.

⁽³⁾ For LC●K●●●●3 / LP●K●●●●3 with spring terminal, lth max = 10 A.

⁽⁴⁾ (0.8...1.15 Uc) for single voltage coil; (0.85...1.1 Uc) for dual voltage coil, exemple 200/208 V AC.

TeSys contactors

Reversing contactors for motor control, 6 to 12 A in categories AC-3 and AC-4

Control circuit: d.c. or low consumption

Reversing contactor selection according to utilisation category, see pages A6/25 to A6/29 and A6/32 to A6/35. Integral mechanical interlock.

It is essential to link the contacts of the electrical interlock.

Pre-wired power circuit connections as standard on screw clamp versions.

Mounting on 35 mm rail or Ø4 screw fixing.

Screws in the open "ready-to-tighten" position.

Add-on auxiliary contact blocks and accessories, see pages B8/49 to B8/51.

3-pole reversing contactors, d.c. supply

Standard power ratings of 3-phase motors 50-60 Hz in category AC-3				Rated operational current in category AC-3 440 V up to	Instantaneous auxiliary contacts per contactor	Basic reference, to be completed by adding the voltage code ⁽¹⁾⁽²⁾
220 V	380 V	440/500 V				
230 V	415 V	660/690 V				
kW	kW	kW	A			
Screw clamp connections						
1.5	2.2	3	6	1	–	LP2K0610●●
				–	1	LP2K0601●●
2.2	4	4	9	1	–	LP2K0910●●
				–	1	LP2K0901●●
3	5.5	4 (> 440)	12	1	–	LP2K1210●●
		5.5 (440)		–	1	LP2K1201●●

Spring terminal connections ⁽³⁾

In the references selected above, insert a figure 3 before the voltage code.

Example: LP2 K0610●● becomes LP2 K06103●●.

Faston connectors, 1 x 6.35 or 2 x 2.8

In the references selected above, insert a figure 7 before the voltage code.

Example: LC2 K0610●● becomes LC2 K06107●●.

Solder pins for printed circuit boards

For 6 to 16 A ratings, in the references selected above, insert a figure 5 before the voltage code.

Example: LC2 K0610●● becomes LC2 K06105●●.

3-pole low consumption reversing contactors

Compatible with programmable controller outputs.

Wide range coil (0.7...1.30 Uc), suppressor fitted as standard, consumption 1.8 W.

Screw clamp connections

1.5	2.2	3	6	1	–	LP5K0610●●
				–	1	LP5K0601●●
2.2	4	4	9	1	–	LP5K0910●●
				–	1	LP5K0901●●
3	5.5	4 (> 440)	12	1	–	LP5K1210●●
		5.5 (440)		–	1	LP5K1201●●

Spring terminal connections

In the references selected above, insert a figure 3 before the voltage code.

Example: LP5 K0610●● becomes LP5 K06103●●.

Faston connectors, 1 x 6.35 or 2 x 2.8

In the references selected above, insert a figure 7 before the voltage code.

Example: LP5 K0610●● becomes LP5 K06107●●.

Solder pins for printed circuit boards

In the references selected above, insert a figure 5 before the voltage code.

Example: LP5 K0610●● becomes LP5 K06105●●.

⁽¹⁾ Standard control circuit voltages (for other voltages, please consult your Regional Sales Office):

d.c. supply

Reversing contactors LP2 K (0.8...1.15 Uc)

Volts	12	20	24 ⁽²⁾	36	48	60	72	100	110	125	155	174	200	220	230	240	250
Code	JD	ZD	BD	CD	ED	ND	SD	KD	FD	GD	PD	QD	LD	MD	MPD	MUD	UD

Coil with integral suppression device available: add 3 to the code required. Example: JD3.

Low consumption

Reversing contactors LP5 K (0.7...1.3 Uc)

Volts	12	20	24	48	72	110	120
Code	JW3	ZW3	BW3	EW3	SW3	FW3	GW3

Coil with integral suppression device fitted as standard, by bi-directional peak limiting diode.

⁽²⁾ For LP2 K only, when connecting an electronic sensor or timer in series with the contactor coil, select a 20 V coil (~ control circuit voltage code Z7, --- control circuit voltage code ZD) so as to compensate for the incurred voltage drop.

⁽³⁾ For LC●K●●●●3 / LP●K●●●●3 with spring terminal, I_{th} max = 10 A.

TeSys contactors

Reversing contactors for control in category AC-1, 20 A

Control circuit: a.c.

Warning: reversing contactors LC2 K0910●● and LC2 K0901●● are pre-wired for reverse motor operation as standard.

Reversing contactor selection according to utilisation category, see pages A6/30 and A6/31.

Integral mechanical interlock.

It is essential to link the contacts of the electrical interlock.

Mounting on 35 mm rail or Ø4 screw fixing.

Screws in the open "ready-to-tighten" position.

Add-on auxiliary contact blocks and accessories, see pages B8/49 to B8/51.

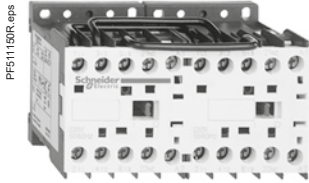

LC2 K0910●●

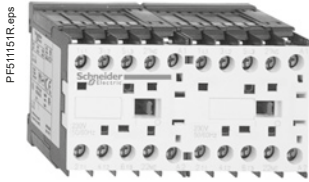

LC2 K09105●●

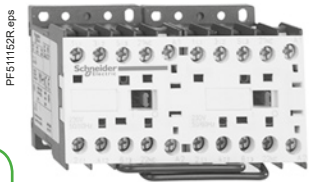

LC2 K09004●●

3 or 4-pole reversing contactors for standard applications ⁽¹⁾

Non-inductive loads Category AC-1 Maximum current at θ ≤ 50 °C	Number of poles	Instantaneous auxiliary contacts per contactor	Basic reference, to be completed by adding the voltage code ^{(2) (3)}

A	Screw clamp connections				
20	3	-	1	-	LC2K0910●● or LC2K1210●●
	3	-	-	1	LC2K0901●● or LC2K1201●●
	4	-	-	-	LC2K09004●● or LC2K12004●●

Spring terminal connections ⁽⁴⁾

In the references selected above, insert a figure 3 before the voltage code.

Example: LC2 K0910●● becomes LC2 K09103●●.

Faston connectors, 1 x 6.35 or 2 x 2.8

In the references selected above, insert a figure 7 before the voltage code.

Example: LC2 K0910●● becomes LC2 K09107●●.

Solder pins for printed circuit boards

In the references selected above, insert a figure 5 before the voltage code.

Example: LC2 K0910●● becomes LC2 K09105●●.

3 or 4-pole silent reversing contactors ⁽¹⁾

Recommended for use in areas sensitive to noise, high interference mains supplies, etc.

Coil with rectifier incorporated, suppressor fitted as standard.

A	Screw clamp connections				
20	3	-	1	-	LC8K0910●● or LC8K1210●●
	3	-	-	1	LC8K0901●● or LC8K1201●●
	4	-	-	-	LC8K09004●● or LC8K12004●●

Faston connectors, 1 x 6.35 or 2 x 2.8

In the references selected above, insert a figure 7 before the voltage code.

Example: LC8 K0910●● becomes LC8 K09107●●.

Solder pins for printed circuit boards

In the references selected above, insert a figure 5 before the voltage code.

Example: LC8 K0910●● becomes LC8 K09105●●.

⁽¹⁾ Selection between 9 and 12 A ratings according to number of operating cycles, see AC-1 curve on page A6/30.

⁽²⁾ Standard control circuit voltages (for other voltages, please consult your Regional Sales Office):

a.c. supply ⁽⁵⁾

Reversing contactors LC2 K (0.8...1.15 Uc) (0.85...1.1 Uc)

Volts	12	20	24 ⁽³⁾	36	42	48	110	115	120	127	200/208	220/230	230	230/240
50/60 Hz	J7	Z7	B7	C7	D7	E7	F7	FE7	G7	FC7	L7	M7	P7	U7
Volts	256	277	380/400	400	400/415	440	480	500	575	600	660/690			
50/60 Hz	W7	UE7	Q7		V7	N7		R7	T7	S7	SC7	X7	Y7	

Up to and including 240 V, coil with integral suppression device available: add 2 to the code required. Example: J72.

Reversing contactors LC8 K (0.8...1.1 Uc)

Volts	24	42	48	110	115	220	230/240
50/60 Hz	B7		D7	E7	F7	FE7	M7
							U7

⁽³⁾ For mains supplies with a high level of interference (voltage surge > 800 V), use a suppressor module LA4 KE1FC (50...129 V) or LA4 KE1UG (130...250 V), see page B8/50.

⁽⁴⁾ For LC●K●●●●3 / LP●K●●●●3 with spring terminal, lth max = 10 A.

⁽⁵⁾ (0.8...1.15 Uc) for single voltage coil; (0.85...1.1 Uc) for dual voltage coil, exemple 200/208 V AC.

TeSys contactors

Reversing contactors for control in category AC-1, 20 A

Control circuit: d.c. or low consumption

Warning: reversing contactors LP2 K0910●● and LP2 K0901●● are pre-wired for reverse motor operation as standard.

Reversing contactor selection according to utilisation category, see pages A6/30 and A6/31.

Integral mechanical interlock.



It is essential to link the contacts of the electrical interlock.

Mounting on 35 mm rail or Ø4 screw fixing.

Screws in the open "ready-to-tighten" position.

Add-on auxiliary contact blocks and accessories, see pages B8/49 to B8/51.

3 or 4-pole reversing contactors, d.c. supply ⁽¹⁾

Non-inductive loads Category AC-1 Maximum current at $\theta \leq 50^\circ\text{C}$	Number of poles	Instantaneous auxiliary contacts per contactor	Basic reference, to be completed by adding the voltage code ^{(2) (3)}		
					
A					
Screw clamp connections					
20	3	-	1	-	LP2K0910●● or LP2K1210●●
	3	-	-	1	LP2K0901●● or LP2K1201●●
	4	-	-	-	LP2K09004●● or LP2K12004●●

Spring terminal connections ⁽⁴⁾

In the references selected above, insert a figure 3 before the voltage code.

Example: LP2 K0910●● becomes LP2 K09103●●.

Faston connectors, 1 x 6.35 or 2 x 2.8

In the references selected above, insert a figure 7 before the voltage code.

Example: LP2 K0910●● becomes LP2 K09107●●.

Solder pins for printed circuit boards

In the references selected above, insert a figure 5 before the voltage code.

Example: LP2 K0910●● becomes LP2 K09105●●.

3 or 4-pole low consumption reversing contactors ⁽¹⁾

Compatible with programmable controller outputs.

Wide range coil (0.7...1.30 U_c), suppressor fitted as standard, consumption 1.8 W.

Screw clamp connections

20	3	-	1	-	LP5K0910●●●● or LP5K1210●●●●
	3	-	-	1	LP5K0901●●●● or LP5K1201●●●●
	4	-	-	-	LP5K09004●●●● or LP5K12004●●●●

Spring terminal connections

In the references selected above, insert a figure 3 before the voltage code.

Example: LP5 K0910●● becomes LP5 K09103●●.

Faston connectors, 1 x 6.35 or 2 x 2.8

In the references selected above, insert a figure 7 before the voltage code.

Example: LP5 K0910●● becomes LP5 K09107●●.

Solder pins for printed circuit boards

In the references selected above, insert a figure 5 before the voltage code.

Example: LP5 K0910●● becomes LP5 K09105●●.

⁽¹⁾ Selection between 9 and 12 A ratings according to number of operating cycles, see AC-1 curve on page A6/30.

⁽²⁾ Standard control circuit voltages (for other voltages, please consult your Regional Sales Office):

d.c. supply (reversing contactors LP2 K: 0.8...1.15 U_c)

Volts ---	12	20	24 ⁽³⁾	36	48	60	72	100	110	125	155	174	200	220	230	240	250
Code	JD	ZD	BD	CD	ED	ND	SD	KD	FD	GD	PD	QD	LD	MD	MPD	MUD	UD

Coil with integral suppression device available: add 3 to the code required. Example: JD3.

Low consumption (reversing contactors LP5 K: 0.7...1.3 U_c)

Volts ---	12	20	24	48	72	110	120
Code	JW3	ZW3	BW3	EW3	SW3	FW3	GW3

Coil with integral suppression device fitted as standard, by bi-directional peak limiting diode.

⁽³⁾ For LP2 K only, when connecting an electronic sensor or timer in series with the contactor coil, select a 20 V coil (~ control circuit voltage code Z7, --- control circuit voltage code ZD) so as to compensate for the incurred voltage drop.

⁽⁴⁾ For LC●K●●●●3 / LP●K●●●●3 with spring terminal, I_{th} max = 10 A.



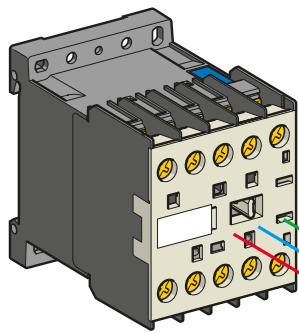

LC1, LC7, LP1 K

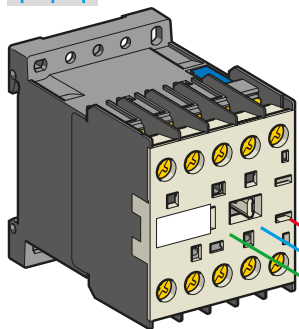

LC1, LC7, LP1 K

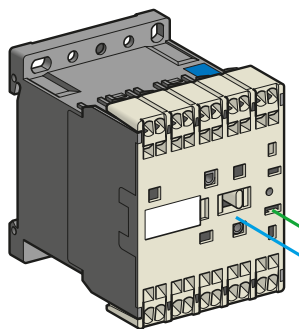

LC1, LP1 K

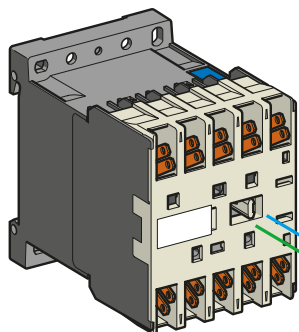

LC1, LC7, LP1 K



Contactor

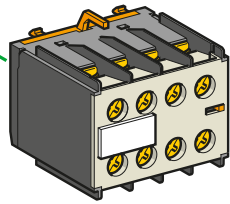

LA1 KN...M

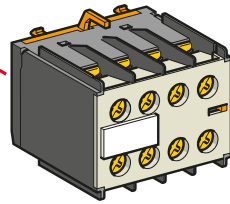

LA1 KN...

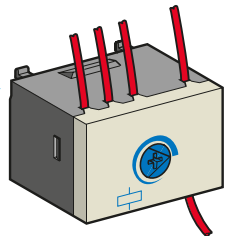

LA2 KT2...

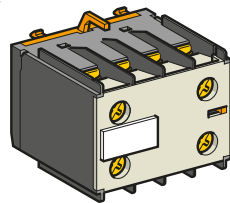

LA1 KN...P

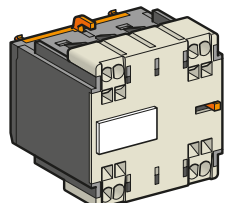

LA1 KN...3

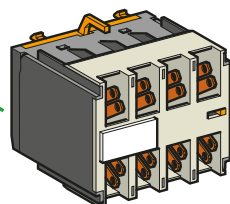

LA1 KN...7

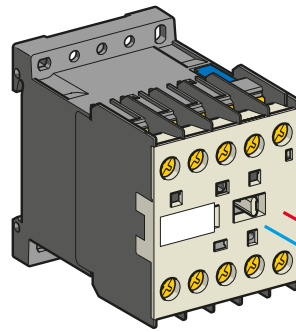

LP4

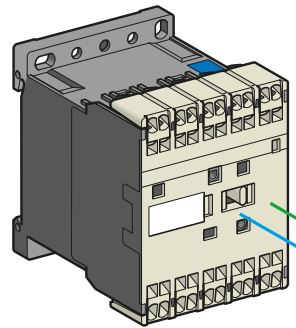

LP4

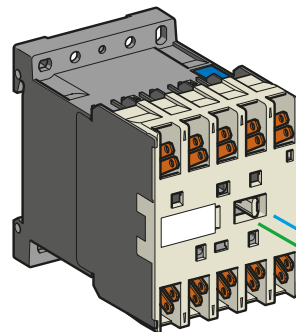

LP4

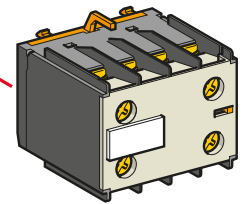

LA1 KN...

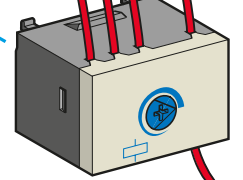

LA2 KT2...

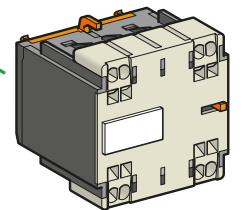

LA1 KN...3

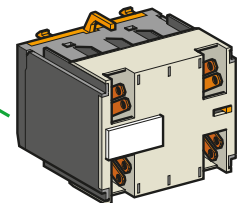

LA1 KN...7



TeSys contactors

TeSys K contactors and reversing contactors

Auxiliary contact blocks

Instantaneous auxiliary contact blocks

Recommended for standard applications. Clip-on front mounting, 1 block per contactor

Connection	For use on contactors	Composition		Reference
				
Screw clamp terminals	All products with screw clamp terminals	2	–	LA1KN20
		–	2	LA1KN02
		1	1	LA1KN11
	All products with screw clamp terminals except low consumption	4	–	LA1KN40
		3	1	LA1KN31
		2	2	LA1KN22
		1	3	LA1KN13
–	4	LA1KN04		
Spring terminals	All products with spring terminals	2	–	LA1KN203
		–	2	LA1KN023
		1	1	LA1KN113
	All products with spring terminals except low consumption	4	–	LA1KN403
		3	1	LA1KN313
		2	2	LA1KN223
		1	3	LA1KN133
–	4	LA1KN043		
Faston connectors, 1 x 6.35 or 2 x 2.8	All products with Faston connectors	2	–	LA1KN207
		–	2	LA1KN027
		1	1	LA1KN117
	All products with Faston connectors except low consumption	4	–	LA1KN407
		3	1	LA1KN317
		2	2	LA1KN227
		1	3	LA1KN137
–	4	LA1KN047		

With terminal referencing to standard EN 50012. Clip-on front mounting, 1 block per contactor

Screw clamp terminals with referencing conforming to standard EN 50012	All 3-pole + N/O products with screw clamp terminals except LP4 and LP5 K12	–	2	LA1KN02M
		1	1	LA1KN11M
	All 3-pole + N/O products with screw clamp terminals except LP4 or LP5 K06, K09 and K12	3	1	LA1KN31M
		2	2	LA1KN22M
		1	3	LA1KN13M
All 4-pole products with screw clamp terminals except LP4 or LP5 K12	1	1	LA1KN11P	
All 4-pole products with screw clamp terminals except LP4 or LP5 K09 and K12	2	2	LA1KN22P	

Electronic time delay auxiliary contact blocks

Relay output with common point changeover contact, ~ or ≡ 240 V, 2 A maximum.

Control voltage 0.85...1.1 Uc.

Maximum switching capacity 250 VA or 150 W.

Operating temperature -10...+60 °C.

Reset time: 1.5 s during the time delay period, 0.5 s after the time delay period.

Clip-on front mounting, 1 block per contactor

Voltage	Type	Timing range	Composition	Reference
				
V		s		
~ or ≡ 24...48	On-delay	1...30	1	LA2KT2E
~ 110...240	On-delay	1...30	1	LA2KT2U

Contactors

TeSys contactors

TeSys K contactors and reversing contactors

Suppressor modules incorporating LED indicator

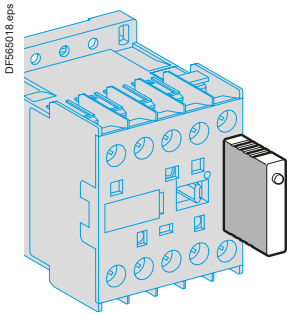

LA4 K●●●

References

Mounting and connection	Type	For voltages	Sold in lots of	Unit reference
Clip-on fixing on the front of contactors LC1 and LP1, with locating device. No tools required.	Varistor ⁽¹⁾	~ and ≍ 12...24 V	5	LA4KE1B
		~ and ≍ 32...48 V	5	LA4KE1E
		~ and ≍ 50...129 V	5	LA4KE1FC
		~ and ≍ 130...250 V	5	LA4KE1UG
Diode + Zener diode ⁽²⁾		≍ 12...24 V	5	LA4KC1B
		≍ 32...48 V	5	LA4KC1E
	RC ⁽³⁾	~ 110...250 V	5	LA4KA1U

(1) Protection provided by limiting the transient voltage to 2 Uc max.
Maximum reduction of transient voltage peaks.
Slight increase in drop-out time (1.1 to 1.5 times the normal time).

(2) No overvoltage or oscillating frequency.

Polarised component.

Slight increase in drop-out time (1.1 to 1.5 times the normal time).

(3) Protection by limiting the transient voltage to 3 Uc max. and limitation of the oscillating frequency.

Slight increase in drop-out time (1.2 to 2 times the normal time).

TeSys contactors

TeSys K contactors and reversing contactors

Accessories

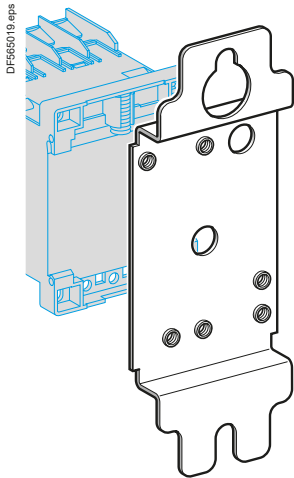

DX1 AP25

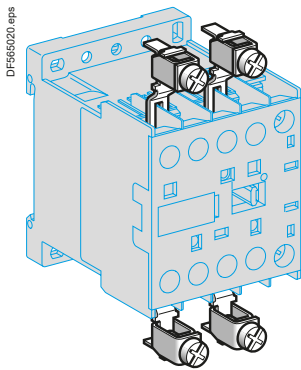

LA9 E01

Mounting and marking accessories

Description	Application		Sold in lots of	Unit reference
Mounting plates ⁽¹⁾	For fixing on 1 rail	Clip-on	1	LA9D973
	For fixing on 2 rails	110/120 mm fixing centres	10	DX1AP25
Marker holder	Clip-on	Onto front of contactor	100	LA9D90
Clip-in markers	4 maximum per contactor	Strips of 10 identical numbers 0...9	25	AB1R● ⁽²⁾
		Strips of 10 identical letters A...Z	25	AB1G● ⁽²⁾

Connection accessories

Description	Application		Sold in lots of	Unit preference
Paralleling links	For 2 poles	With screw clamps	4	LA9E01
	For 4 poles	With screw clamps	2	LA9E02
Set of 6 power connections	For 3-pole reversing contactors for motor control	For contactors with screw clamp terminals	100	LA9K0969
Set of 4 power connections	For 4-pole changeover contactor pairs	For contactors with screw clamp terminals	100	LA9K0970

⁽¹⁾ Order 1 mounting plate for fixing a contactor and 2 mounting plates for fixing a reversing contactor.

⁽²⁾ Complete the reference by replacing the dot with the required character.

TeSys contactors

Mini-contactors TeSys LC1 SKGC, for use in modular panels

- Mounting on 35 mm rail or fixing by four Ø4 screws, except for LC1 SKGC200.
- Connection by connectors.
- Mini-contactor fitted with transparent, sealable protective cover to prevent front face access.



LC1 SKGC200

Mini-contactors, width 27 mm

Standard power ratings of 3-phase motors 50/60 Hz in category AC-3			Rated operational current in AC-3 up to 400 V	Non inductive loads category AC-1 maximum current $\theta \leq 50^\circ\text{C}$	No. of poles			Basic reference, to be completed by adding the voltage code ⁽¹⁾
220 V	380 V	660 V						
230 V	415 V	690 V	A	A	2	-	-	LC1SKGC200●●
kW	kW	kW	A	A				
-	-	-	5	20				

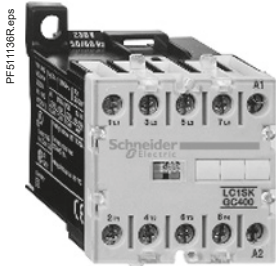

LC1 SKGC400

Mini-contactors, width 45 mm

Standard power ratings of 3-phase motors 50/60 Hz in category AC-3			Rated operational current in AC-3 up to 400 V	Non inductive loads category AC-1 maximum current $\theta \leq 50^\circ\text{C}$	No. of poles			Basic reference, to be completed by adding the voltage code ⁽¹⁾
220 V	380 V	660 V						
230 V	415 V	690 V	A	A	3	1	-	LC1SKGC310●●
kW	kW	kW	A	A				
1.1	4	4	9	20	3	1	-	LC1SKGC301●●
					3	-	1	LC1SKGC301●●
					4	-	-	LC1SKGC400●●

(1) Standard control circuit voltages (for other voltages, please consult your Regional Sales Office):

Volts ~ 50/60 Hz	24	48	110	120	220	230	240	380	400
Code	B7	E7	F7	G7	M7	P7	U7	Q7	V7

TeSys contactors

Mini-contactors TeSys LC1 SKGC, for use in modular panels

Suppressor modules



Suppressor modules

Connection without need for tools by clipping onto right-hand side of contactor

For use on contactors	Type	For voltages	Sold in lots of	Unit reference
LC1SKGC	Varistor ⁽¹⁾	~ and ≡ 24...48 V	10	LA4SKE1E
		~ and ≡ 110...250 V	10	LA4SKE1U
	Diode ⁽²⁾	≡ 24...250 V	10	LA4SKC1U

(1) Protection provided by limiting the transient voltage to 2 U_c max.
Maximum reduction of transient voltage peaks.

Slight increase in drop-out time (1.1 to 1.5 times the normal time).

(2) No overvoltage or oscillating frequency.

Slight increase in drop-out time (1.1 to 1.5 times the normal time).

Modular equipment
Standard contactors TeSys GC



GC 2520



GC 4040



GC 10020

Standard contactors, TeSys GC								
No. of poles	Diagram	Number of 17.5 mm modules	Commercial reference 50 Hz coil - different voltages					Sold in lots of
			12 V	24 V	48 V	110 V	220/240 V	
Maximum current rating category AC-7a - 16 A								
1	—	1	GC1610J5	GC1610B5	GC1610E5	GC1610F5	GC1610M5	★ 12
1	1	1	GC1611J5	GC1611B5	—	GC1611F5	GC1611M5	★ 12
2	—	1	GC1620J5	GC1620B5	GC1620E5	GC1620F5	★ GC1620M5	★ 12
2	2	2	—	GC1622B5	GC1622E5	GC1622F5	★ GC1622M5	6
3	—	2	—	—	—	—	GC1630B5	6
							GC1630M5	★
4	—	2	—	GC1640B5	—	GC1640F5	GC1640M5	★ 6
Maximum current rating category AC-7a - 25 A								
—	2	1	—	GC2502B5	GC2502E5	★	GC2502M5	★ 12
—	4	2	—	GC2504B5	GC2504E5	★	GC2504M5	★ 6
1	—	1	—	GC2510B5	—	—	GC2510M5	★ 12
1	1	1	—	GC2511B5	—	GC2511F5	GC2511M5	★ 12
2	—	1	GC2520J5	GC2520B5	GC2520E5	GC2520F5	★ GC2520M5	★ 12
2	2	2	—	GC2522B5	GC2522E5	GC2522F5	★ GC2522M5	★ 6
3	—	2	—	GC2530B5	—	GC2530F5	★ GC2530M5	★ 6
3	1	2	—	—	—	—	GC2531M5	★ 6
4	—	2	GC2540J5	GC2540B5	GC2540E5	GC2540F5	★ GC2540M5	★ 6
Maximum current rating category AC-7a - 40 A								
—	2	2	—	GC4002B5	—	—	GC4002M5	★ 6
—	4	3	—	GC4004B5	—	GC4004F5	★ GC4004M5	4
1	1	2	—	GC4011B5	—	—	GC4011M5	★ 6
2	—	2	—	GC4020B5	—	GC4020F5	★ GC4020M5	★ 6
2	2	3	—	—	—	—	GC4022M5	4
3	—	3	—	GC4030B5	—	GC4030F5	★ GC4030M5	★ 4
4	—	3	—	GC4040B5	GC4040E5	GC4040F5	★ GC4040M5	★ 4
Maximum current rating category AC-7a - 63 A								
—	2	2	—	—	—	—	GC6302M5	6
—	4	3	—	GC6304B5	—	—	GC6304M5	4
1	1	2	—	—	—	—	GC6311M5	6
2	—	2	—	—	—	—	GC6320M5	6
2	2	3	—	—	—	GC6322F5	★ GC6322M5	4
3	—	3	—	GC6330B5	—	GC6330F5	★ GC6330M5	★ 4
4	—	3	—	GC6340B5	GC6340E5	GC6340F5	★ GC6340M5	★ 4
Maximum current rating category AC-7a - 100 A								
2	—	3	—	—	—	—	GC10020M5	4
4	—	6	—	GC10040B5	—	—	★ GC10040M5	★ 2

★ for 60 Hz coil replace last figure 5 by 6.

References - TeSys GY

Modular equipment

TeSys GY "dual tariff" contactors

PB113083_13.eps



GY 2520M5

PB113087_26.eps



GY 6340M5

TeSys GY "dual tariff" contactors							
No. of poles	Number of 17.5 mm modules	Commercial reference 50 Hz coil - different voltages					Sold in lots of
		12 V	24 V	48 V	110 V	220/240 V	
Maximum current rating category AC-7a - 16 A							
2	1	–	GY1620B5	–	–	GY1620M5	12
4	2	–	–	–	–	GY1640M5	6
Maximum current rating category AC-7a - 25 A							
2	1	–	GY2520B5	–	–	GY2520M5 ★	12
3	2	–	–	–	–	GY2530M5	6
4	2	–	GY2540B5	–	–	GY2540M5	6
Maximum current rating category AC-7a - 40 A							
2	2	–	–	–	–	GY4020M5	6
3	3	–	–	–	–	GY4030M5	4
4	3	–	GY4040B5	–	–	GY4040M5	4
Maximum current rating category AC-7a - 63 A							
2	2	–	–	–	–	GY6320M5	6
4	3	–	GY6340B5	–	–	GY6340M5	4

★ for 60 Hz coil replace last figure 5 by 6.

References - TeSys GF

Modular equipment

TeSys GF impulse relays



GF 1611M7

TeSys GF impulse relays						
Maximum current rating category AC-1	Composition	Coil voltages		Sold in lots of	Unit reference	
		~ 50/60 Hz	DC			
A		V	V			
16	1	-	12	6	12	GF1610J7
			24	12	12	GF1610B7
			48	24	12	GF1610E7
			110	48	12	GF1610F7
			220	-	12	GF1610M7
			230/240	110	12	GF1610U7
	2	-	12	6	12	GF1620J7
			24	12	12	GF1620B7
			48	24	12	GF1620E7
			110	48	12	GF1620F7
			220	-	12	GF1620M7
			230/240	110	12	GF1620U7
1	1	12	6	12	GF1611J7	
		24	12	12	GF1611B7	
		48	24	12	GF1611E7	
		110	48	12	GF1611F7	
		220	-	12	GF1611M7	
		230/240	110	12	GF1611U7	

Modular equipment

TeSys GC, GY accessories



GAP 23



GAC 5



A9A15922



A9A15923

Instantaneous auxiliary contact blocks

Number of contacts	Number of poles			Reference
2				
	1	1	-	GAC0521
	-	2	-	GAC0531
-	-	1		GAC0511

Accessories

Description	For use on contactor	Number of modules	Operational voltage in V	Sold in lots of	Unit reference
Coil suppression blocks comprising 2 RC circuits	-	1	12...48	1	GAP21
	-	-	110...240	1	GAP23
Ventilation 1/2 module clips onto rail	-	1/2	-	10	GAC5
Set of screw shields (10 top parts + 10 bottom parts)	40 or 63 A	2	-	1	A9A15922
	40 or 63 A	3	-	1	A9A15923
					2 contacts
					3 or 4 contacts

Technical Data for Designers

Contents

TeSys D, TeSys D Green:

- > characteristics.....B8/61 to B8/73
- > dimensions.....B8/74 to B8/87

TeSys SK:

- > characteristics.....B8/88 to B8/91
- > dimensions.....B8/92

TeSys K:

- > characteristics.....B8/93 to B8/96
- > dimensions.....B8/97 to B8/100

TeSys SKGC:

- > characteristics.....B8/101 to B8/104
- > dimensions.....B8/105

TeSys GC:

- > characteristics.....B8/106 to B8/113
- > dimensions.....B8/114 and B8/115

TeSys GY:

- > characteristics.....B8/116 to B8/119
- > dimensions.....B8/120 and B8/78

TeSys GF:

- > characteristics.....B8/122 to B8/125
- > dimensions.....B8/126

Standard IEC tests - Contactors
conforming to UL/CSA.....B8/127

TeSys contactors

TeSys D, TeSys D Green contactors

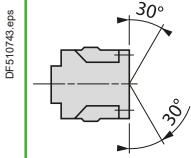
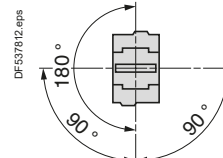
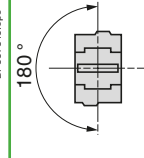
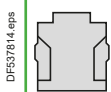
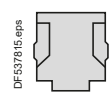
Environment							
Contactor type LC1		D09...D18 DT20 and DT25	D25...D38 DT32 and DT40	D40A...D80A DT60A and DT80A	D80...D95	D115 and D150	
Rated insulation voltage (Ui)	Conforming to IEC 60947-4-1, overvoltage category III, degree of pollution: 3	V	690			1000	
	Conforming to UL, CSA	V	600				
Rated impulse withstand voltage (Uimp)	Conforming to IEC 60947	kV	6			8	
Conforming to standards			IEC/EN 60947-4-1, IEC/EN 60947-5-1, UL 60947-4-1, CSA C22.2 n° 60947-4-1, UL 60947-5-1, CSA C22.2 n° 60947-5-1, GB/T 14048.4				
Product certifications ⁽¹⁾			UL, CSA, CCC, EAC, CB certification, EU-MR-RO by DNV-GL		UL, CSA, CCC, EAC, CB certification, DNV-GL, RINA, BV, LRoS		
Degree of protection ⁽²⁾ (front face)	Conforming to IEC 60529						
	Power circuit connections		Protection against direct finger contact IP20				
	Coil connection		Protection against direct finger contact IP20				
Climatic withstand			According to IACS E10 and IEC 60947-1 Annex Q category D		According to IACS E10		
Ambient air temperature around the device	Storage	°C	-60...+80				
	Operation ⁽³⁾	°C	-40...+60				
	Allowed with derating ^{(3) (4)}	°C	+60...+70 at U _c to 1.●● x U _c				
Maximum operating altitude	Without derating	m	3000				
Operating positions ⁽⁵⁾	Without derating in the following positions		AC and DC coils AC/DC and "BBE" coils 	AC coils AC/DC and "BBE" coils 	DC coils 		
	Positions that are not allowed		For --- contactors LC1 D09 to LC1 D150.  				
Flame resistance	Conforming to IEC 60695-2-11	°C	850				
Shock resistance ⁽⁶⁾ 1/2 sine wave = 11 ms	Contactor open		10 gn	8 gn	10 gn	8 gn	6 gn
	Contactor closed		15 gn	15 gn	15 gn	10 gn	15 gn
Vibration resistance ⁽⁶⁾ 5...300 Hz	Contactor open		2 gn				
	Contactor closed		4 gn	4 gn	4 gn	3 gn	4 gn

(1) Contactor LC1 D95 with d.c. coil is not UL/CSA certified.
 (2) Protection provided for the cabling c.s.a.'s indicated on the next page and for connection by cable. For lug type: add a protective cover.
 (3) As per IEC60947-4-1, operating time and drop out voltage given and tested for -5...+40 °C.
 (4) Refer to operational current in AC1 (page A6/30).
 (5) When mounting on a vertical rail, use a stop.
 (6) Without modifying the power contact states, in the most unfavourable direction (coil energised at U_e).
 In case of vibration, it is recommended to mount the devices separately by screws on metal plate.

Contactors

TeSys contactors

TeSys D, TeSys D Green contactors

Pole characteristics TeSys D, TeSys D Green										
Contactor type		LC1	D09 (3P)	DT20 D098	D12 (3P)	DT25 D128	D18 (3P)	DT32 D188	D25 (3P)	DT40 D258
Rated operational current (Ie) (Ue ≤ 440 V)	In AC-3, θ ≤ 60 °C	A	9		12		18		25	
	In AC-1, θ ≤ 60 °C	A	25 ⁽¹⁾	20	25 ⁽¹⁾	25	32 ⁽¹⁾	32	40 ⁽¹⁾	40
Rated operational voltage (Ue)	Up to	V	690		690		690		690	
Frequency limits	Of the operational current	Hz	25...400		25...400		25...400		25...400	
Conventional thermal current (Ith)	θ ≤ 60 °C	A	25 ⁽¹⁾	20	25 ⁽¹⁾	25	32 ⁽¹⁾	32	40 ⁽¹⁾	40
Rated making capacity (440 V)	Conforming to IEC 60947	A	250		250		300		450	
Rated breaking capacity (440 V)	Conforming to IEC 60947	A	250		250		300		450	
Permissible short time rating No current flowing for preceding 15 minutes with θ ≤ 40 °C	For 1 s	A	210		210		240		380	
	For 10 s	A	105		105		145		240	
	For 1 min	A	61		61		84		120	
	For 10 min	A	30		30		40		50	
Fuse protection against short-circuits (U ≤ 690 V)	Without thermal overload relay, gG fuse	type 1	A	25	40	50	63			
		type 2	A	20	25	35	40			
	With thermal overload relay	A	See pages B11/4 and B11/5, for aM or gG fuse ratings corresponding to the associated thermal overload relay							
Average impedance per pole	At Ith and 50 Hz	mΩ	2.5		2.5		2.5		2	
Power dissipation per pole for the above operational currents	AC-3	W	0.20		0.36		0.8		1.25	
	AC-1	W	1.56		1.56		2.5		3.2	

Control circuit characteristics, a.c. supply TeSys D					
Rated control circuit voltage (Uc)	50/60 Hz	V	12...690		
Control voltage limits	50 or 60 Hz coils	Operation	-		
		Drop-out	-		
	50/60 Hz coils	Operation	0.8...1.1 Uc on 50 Hz and 0.85...1.1 Uc on 60 Hz at 60 °C		
		Drop-out	0.3...0.6 Uc at 60 °C		
Average consumption at 20 °C and at Uc	~ 50 Hz Inrush	50 Hz coil	VA	-	
		Cos φ		0.75	
		50/60 Hz coil	VA	70	
		Sealed	50 Hz coil	VA	-
			Cos φ		0.3
		50/60 Hz coil	VA	7	
	~ 60 Hz Inrush	60 Hz coil	VA	-	
		Cos φ		0.75	
		50/60 Hz coil	VA	70	
		Sealed	60 Hz coil	VA	-
			Cos φ		0.3
		50/60 Hz coil	VA	7.5	
Heat dissipation	50/60 Hz	W	2...3		
Operating time ⁽²⁾	Closing "C"	ms	12...22		
	Opening "O"	ms	4...19		
Mechanical durability in millions of operating cycles	50 or 60 Hz coil		-		
	50/60 Hz coil on 50 Hz		15		
Maximum operating rate at ambient temperature ≤ 60 °C	In operating cycles per hour		3600		

(1) Versions with spring terminal connections:

16 A for LC1 D093 and LC1 D123 (20 A possible with 2 x 2.5 mm² in parallel),

25 A for LC1 D183 to LC1 D323 (32 A possible for LC1 D183 connected with 2 x 4 mm² cables in parallel; 40 A possible for LC1 D253 and LC1 D323 connected with 2 x 4 mm² in parallel).

(2) The closing time "C" is measured from the moment the coil supply is switched on to closure of the main poles. The opening time "O" is measured from the moment the coil supply is switched off to the moment the main poles separate.

D32	D38	D40A	DT60A	D50A	D65A	D80A	DT80A	D80	D95	D115	D150
32	38	40	–	50	65	80	–	80	95	115	150
50 ⁽¹⁾	50	60	60	80	80	80	80	125	125	200	200
690	690	690	690	690	690	690	690	1000	1000	1000	1000
25...400	25...400	25...400	25...400	25...400	25...400	25...400	25...400	25...400	25...400	25...400	25...400
50	50	60	60	80	80	80	80	125	125	200	200
550	550	800	800	900	1000	1000	1000	1100	1100	1260	1660
550	550	800	800	900	1000	1000	1000	1100	1100	1100	1400
430	430	720	720	810	900	900	900	990	1100	1100	1400
260	310	320	320	400	640	640	640	640	800	950	1200
138	150	165	165	208	260	260	260	320	400	550	580
60	60	72	72	84	110	110	110	135	135	250	250
63	63	80	80	100	125	125	125	200	200	250	315
63	63	80	80	100	125	125	125	160	160	200	250

See pages B11/4 and B11/5 for aM or gG fuse ratings corresponding to the associated thermal overload relay

2	2	1.5	1.6	1.5	1.5	1.5	1.6	0.8	0.8	0.6	0.6
2	3	2.4	–	3.7	6.3	6.3	–	5.1	7.2	7.9	13.5
5	5	5.4	5.8	9.6	9.6	9.6	10.2	12.5	12.5	24	24

12...690	12...690							24...500
–	–	0.85...1.1 Uc at 55 °C						
–	–	0.3...0.6 Uc at 55 °C						0.3...0.5 Uc at 55 °C
0.8...1.1 Uc on 50 Hz and 0.85...1.1 Uc on 60 Hz at 60 °C	0.8...1.1 Uc on 50 Hz and 0.85...1.1 Uc on 60 Hz at 60 °C	0.8...1.1 Uc on 50 Hz and 0.85...1.1 Uc on 60 Hz at 55 °C						0.8...1.15 Uc on 50/60 Hz at 55 °C
0.3...0.6 Uc at 60 °C	0.3...0.6 Uc at 60 °C	0.3...0.6 Uc at 55 °C						0.3...0.5 Uc at 55 °C
–	–	200						300
0.75	0.75	0.75						0.8
70	160	245						280...350
–	–	20						22
0.3	0.3	0.3						0.3
7	15	26						2...18
–	–	220						300
0.75	0.75	0.75						0.8
70	140	245						280...350
–	–	22						22
0.3	0.3	0.3						0.3
7.5	13	26						2...18
2...3	4...5	6...10						3...8
12...22	12...26	12...26	12...26	12...26	12...26	12...26	20...35	
4...19	4...19	4...19	4...19	4...19	4...19	4...19	6...20	
–	–	–	–	–	–	–	10	
15	6	6	6	6	6	6	4	
3600	3600	3600	3600	3600	3600	3600	3600	
							2400	
							1200	

d.c. control circuit characteristics TeSys D							
Contactor type			LC1 D09...D38 LC1 DT20...DT40	LC1 D40A...D80A LC1 DT60A and DT80A	LC1 or LP1 D80 LC1 D95	LC1 D115 and LC1 D150	
Rated control circuit voltage (Uc) ---		V	12...440	12...440		24...440	
Rated insulation voltage	Conforming to IEC 60947-1	V	690				
	Conforming to UL, CSA	V	600				
Control voltage limits	Operation	Standard coil	0.7...1.25 Uc at 60 °C	0.75...1.25 Uc at 60 °C	0.85...1.1 Uc at 55 °C	0.75...1.2 Uc at 55 °C	
		Wide range coil	–	–	0.75...1.2 Uc at 55 °C	–	
	Drop-out		0.1...0.25 Uc at 60 °C	0.1...0.3 Uc at 60 °C	0.1...0.3 Uc at 55 °C	0.15...0.4 Uc at 55 °C	
Average consumption at 20 °C and at Uc	---	Inrush	W	5.4	19	22	270...365
		Sealed	W	5.4	7.4	22	2.4...5.1
Operating time ⁽¹⁾ average at Uc	Closing	"C"	ms	63 ±15 %	50 ±15%	95...130	20...35
	Opening	"O"	ms	20 ±20 %	20 ±20%	20...35	40...75
			<i>Note: The arcing time depends on the circuit switched by the poles. For all normal 3-phase applications, the arcing time is less than 10 ms. The load is isolated from the supply after a time equal to the sum of the opening time and the arcing time.</i>				
Time constant (L/R)		ms	28	34	75	25	
Mechanical durability at Uc	In millions of operating cycles		30	10	10	8	
Maximum operating rate at ambient temperature ≤ 60 °C	In operating cycles per hour		3600	3600	3600	1200	

Low consumption control circuit characteristics TeSys D					
Rated insulation voltage	Conforming to IEC 60947-1	V	690	–	
	Conforming to UL, CSA	V	600	–	
Maximum voltage	Of the control circuit on ---	V	250	–	
Average consumption d.c. at 20 °C and at Uc	Wide range coil (0.8...1.25 Uc)	Inrush	W	2.4	–
		Sealed	W	2.4	–
Operating time ⁽¹⁾ at Uc and at 20 °C	Closing	"C"	ms	77 ±15 %	–
	Opening	"O"	ms	25 ±20 %	–
Voltage limits (θ ≤ 60 °C) of the control circuit	Operation		0.8 to 1.25 Uc	–	
	Drop-out		0.1...0.3 Uc	–	
Time constant (L/R)		ms	40	–	
Mechanical durability	In millions of operating cycles		30	–	
Maximum operating rate at ambient temperature ≤ 60 °C	In operating cycles per hour		3600	–	

(1) The operating times depend on the type of contactor electromagnet and its control mode.
 The closing time "C" is measured from the moment the coil supply is switched on to initial contact of the main poles.
 The opening time "O" is measured from the moment the coil supply is switched off to the moment the main poles separate.

Characteristics

TeSys D Green

Contactors with AC/DC coil

Wide band TeSys D Green AC/DC coil circuit characteristics									
Rated control circuit voltage (Uc)		V	AC/DC 24...250						
Operation		V	0.85 Uc mini...1.1 Uc maxi at 60 °C in AC or DC (BNE coil: 0.8 Uc mini at 24 VDC, 0.85 Uc mini in AC).						
Drop-out		V	0.1 Uc maxi (e.g. 100 to 250 V = 25 V at 60 °C)						
Contactor type		LC1 D09...D38			LC1 D40A...D80A, LC1 DT60A, LC1 DT80A				
Coil code		BNE	EHE	KUE	BBE	BNE	EHE	KUE	
Rated control circuit voltage (Uc)		24-60	48-130	100-250	24 DC	24-60	48-130	100-250	
AC supply at 20°C	Consumption inrush	VA	15	25	25	-	15	23	18
	Consumption sealed	VA	0.9	1.3	1.6	-	1	1.4	1.8
	Consumption sealed	mA	28	15	9	-	35	17	9.5
	Heat dissipation	W	0.6	0.8	1.1	-	0.8	0.9	1.3
DC supply at 20°C	Consumption inrush	W	14	24	18	11	16	19	14
	Consumption sealed	mA	23	13	7	20	30	15	7.7
	Heat dissipation	W	0.6	0.8	1.1	0.5	0.7	0.9	1.2
Max operating time ⁽²⁾	Closing "C"	ms	50 ±5 ms			60 ±5 ms			
	Opening "O"	ms	20...90 ms			20...80 ms			
EMC immunity			Meets IEC 60947-4-1 standard, table 14						
EMC emission		IEC 60947-4-1 §9.4.3	Environment A ⁽¹⁾						
Maximum operating rate at ambient temperature ≤ 60°C		cycle/h	3600						
Mechanical durability at Uc In millions of operating cycles			15			6			

⁽¹⁾ Use of this product in EMC environment B may require mitigation measures to avoid unwanted disturbance.

⁽²⁾ The closing time "C" is measured from the moment the coil supply is switched on to closure of the main poles. The opening time "O" is measured from the moment the coil supply is switched off to the moment the main poles separates.

TeSys contactors

TeSys D, TeSys D Green contactors

Power circuit connections

Screw clamp terminal connections TeSys D, TeSys D Green

Contactor type		LC1	D09 and D12 DT20 and DT25	D18 (3P)	D25 (3P)	D32	D38	D18 and D25 (4P) DT32 and DT40	D40A to D80A DT60A and DT80A ⁽¹⁾	D80 and D95	D115 and D150
Tightening			Screw clamp terminals				Connector 2 inputs	Screw clamp terminals	Connector 1 input	Connector 2 inputs	
Flexible cable without cable end	1 conductor	mm ²	1...4	1.5...6	2.5...10			2.5...10	1...35	4...50	10...120
	2 conductors	mm ²	1...4	1.5...6	2.5...10			2.5...10	1...25 and 1...35	4...25	10...120 + 10...50
Flexible cable with cable end	1 conductor	mm ²	1...4	1...6	1...10			2.5...10	1...35	4...50	10...120
	2 conductors	mm ²	1...2.5	1...4	1.5...6			2.5...10	1...25 and 1...35	4...16	10...120 + 10...50
Solid cable without cable end	1 conductor	mm ²	1...4	1.5...6	1.5...10			2.5...16	1...35	4...50	10...120
	2 conductors	mm ²	1...4	1.5...6	2.5...10			2.5...16	1...25 and 1...35	6...25	10...120 + 10...50
Screwdriver	Philips		N° 2	N° 2	N° 2			N° 2	–	–	–
	Flat screwdriver Ø		Ø6	Ø6	Ø6			Ø6	–	Ø6...Ø8	–
Hexagonal key			–	–	–			–	4	4	4
Tightening torque		N.m	1.7	1.7	2.5			1.8	5: ≤ 25 mm ² 8: 35 mm ²	9	12

Spring terminal connections ⁽²⁾ TeSys D

Flexible cable without cable end	1 conductor	mm ²	2.5 (4: DT25)	4	4	4	–	10	–	–
	2 conductors	mm ²	2.5 (except DT25)	4	4	4	–	–	–	–

Connection by bars or lugs TeSys D

Bar c.s.a.			–	–	–	–	–	–	3 x 16	5 x 25
Lug external Ø		mm	8	8	10	10	8	16.5	17	25
Ø of screw		mm	M3.5	M3.5	M4	M4	M3.5	M6	M6	M8
Screwdriver	Philips		N° 2	N° 2	N° 2	N° 2	N° 2	–	–	–
	Flat screwdriver Ø		Ø6	Ø6	Ø6	Ø6	Ø6	–	Ø8	–
Key for hexagonal headed screw			–	–	–	–	–	10	10	13
Tightening torque		N.m	1.7	1.7	2.5	2.5	1.8	6	9	12

Control circuit connections

Connection by cable (tightening via screw clamps) TeSys D, TeSys D Green

Flexible cable without cable end	1 conductor	mm ²	1...4	1...4	1...4	1...4	1...4	1...4	1...4	1...2.5
	2 conductors	mm ²	1...4	1...4	1...4	1...4	1...4	1...4	1...4	1...2.5
Flexible cable with cable end	1 conductor	mm ²	1...4	1...4	1...4	1...4	1...4	1...4	1...2.5	1...2.5
	2 conductors	mm ²	1...2.5	1...2.5	1...2.5	1...2.5	1...2.5	1...2.5	1...2.5	1...2.5
Solid cable without cable end	1 conductor	mm ²	1...4	1...4	1...4	1...4	1...4	1...4	1...4	1...2.5
	2 conductors	mm ²	1...4	1...4	1...4	1...4	1...4	1...4	1...4	1...2.5
Screwdriver	Philips		N° 2	N° 2	N° 2	N° 2	N° 2	N° 2	N° 2	N° 2
	Flat screwdriver Ø		Ø6	Ø6	Ø6	Ø6	Ø6	Ø6	Ø6	Ø6
Tightening torque		N.m	1.7	1.7	1.7	1.7	1.7	1.7	1.7	1.2

Spring terminal connections ⁽²⁾ TeSys D

Flexible cable without cable end	1 conductor	mm ²	2.5	2.5	2.5	2.5	–	2.5	0.75...2.5	–	–
	2 conductors	mm ²	2.5	2.5	2.5	2.5	–	2.5	0.75...2.5	–	–

Connection by bars or lugs TeSys D

Lug external Ø		mm	8	8	8	8	8	8	8	8
Ø of screw		mm	M3.5	M3.5	M3.5	M3.5	M3.5	M3.5	M3.5	M3.5
Screwdriver	Philips		N° 2	N° 2	N° 2	N° 2	N° 2	N° 2	N° 2	N° 2
	Flat screwdriver Ø		Ø6	Ø6	Ø6	Ø6	Ø6	Ø6	Ø6	Ø6
Tightening torque		N.m	1.7	1.7	1.7	1.7	1.7	1.7	1.7	1.2

⁽¹⁾ BTR screws: hexagon socket head. In accordance with local electrical wiring regulations, a size 4 insulated Allen key must be used (reference **LAD ALLEN4**, see page B8/29).

⁽²⁾ If cable ends are used, choose the next size down (example: for 2.5 mm², use 1.5 mm²) and square crimp the cable ends using a special tool.

TeSys contactors

TeSys D, TeSys D Green contactors

Characteristics of auxiliary contacts incorporated in the contactor

Mechanically linked contacts	Conforming to IEC 60947-5-1		Each contactor has 2 N/O and N/C contacts mechanically linked on the same movable contact holder
Mirror contact	Conforming to IEC 60947-4-1		The N/C contact on each contactor represents the state of the power contacts and can be connected to a PREVENTA safety module
Rated operational voltage (Ue)	Up to	V	690
Rated insulation voltage (Ui)	Conforming to IEC 60947-1	V	690
	Conforming to UL, CSA	V	600
Conventional thermal current (Ith)	For ambient temperature ≤ 60 °C	A	10
Frequency of the operational current		Hz	25...400
Minimum switching capacity $\lambda = 10^{-8}$	U min	V	17
	I min	mA	5
Short-circuit protection	Conforming to IEC 60947-5-1		gG fuse: 10 A
Rated making capacity	Conforming to IEC 60947-5-1, I rms	A	~: 140, ---: 250
Short-time rating	Permissible for	1 s	A 100
		500 ms	A 120
		100 ms	A 140
Insulation resistance		MΩ	> 10
Non-overlap time	Guaranteed between N/C and N/O contacts	ms	1.5 (on energisation and on de-energisation)
Tightening torque	Phillips head n° 2 and Ø6	N.m	1.7

Operational power of contacts conforming to IEC 60947-5-1

a.c. supply, categories AC-14 and AC-15

Electrical durability (valid for up to 3600 operating cycles/hour) on an inductive load such as the coil of an electromagnet: making current ($\cos \varphi 0.7$) = 10 times the power broken ($\cos \varphi 0.4$).

Operating cycles	V	24	48	115	230	400	440	600
1 million	VA	60	120	280	560	960	1050	1440
3 million	VA	16	32	80	160	280	300	420
10 million	VA	4	8	20	40	70	80	100

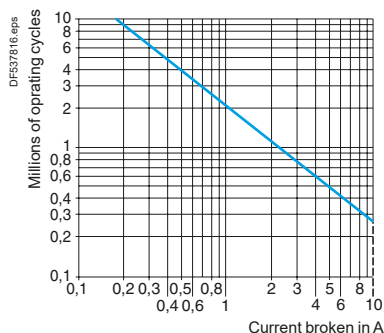

AC-15

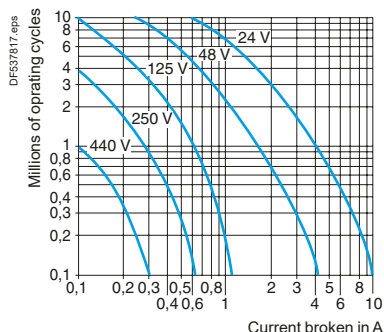

DC-13

d.c. supply, category DC-13

Electrical durability (valid for up to 1200 operating cycles/hour) on an inductive load such as the coil of an electromagnet, without economy resistor, the time constant increasing with the load.

Operating cycles	V	24	48	125	250	440
1 million	W	96	76	76	76	44
3 million	W	48	38	38	32	—
10 million	W	14	12	12	—	—

TeSys contactors

Auxiliary contact blocks without dust and damp protected contacts for TeSys D, TeSys D Green contactors

Environment						
Contact block type			LAD N or LAD C	LAD T and LAD S	LAD R	LAD 8
Conforming to standards			IEC/EN 60947-5-1, UL 60947-5-1, CSA C22.2 n° 60947-5-1, GB/T 14048.5			
Product certifications			UL, CSA, CCC, EAC, CB certification			
Degree of protection	Conforming to IEC 60529		Protection against direct finger contact IP 2X			
Ambient air temperature around the device	Storage	°C	-60...+80			
	Operation	°C	-5...+60			
Maximum operating altitude	Without derating	m	3000			
Connection by cable	Phillips n° 2 and Ø6 mm Flexible or solid cable with or without cable end	mm ²	Min: 1 x 1; max: 2 x 2.5			
Tightening torque		N.m	1.7			
Spring terminal connections	Flexible or solid cable without cable end	mm ²	Max: 2 x 2.5			

Instantaneous and time delay contact characteristics						
Number of contacts			1, 2 or 4	2	2	2
Rated operational voltage (U _e)	Up to	V	690			
Rated insulation voltage (U _i)	Conforming to IEC 60947-5-1	V	690			
	Conforming to UL, CSA	V	600			
Conventional thermal current (I _{th})	For ambient temperature ≤ 60 °C	A	10			
Frequency of the operational current		Hz	25...400			
Minimum switching capacity	U min	V	17			
	I min	mA	5			
Short-circuit protection	Conforming to IEC 60947-5-1 gG fuse	A	10			
Rated making capacity	Conforming to IEC 60947-5-1 I rms	A	~: 140; ∴: 250			
Short-time rating	Permissible for	1 s	A	100		
		500 ms	A	120		
		100 ms	A	140		
Insulation resistance		MΩ	> 10			
Non-overlap time	Guaranteed between N/C and N/O contacts	ms	1.5 (on energisation and on de-energisation)			
Overlap time	Guaranteed between N/C and N/O contacts on LAD C22	ms	1.5	–	–	–
Time delay (LADT, R and S contact blocks) Accuracy only valid for setting range indicated on the front face	Ambient air temperature for operation	°C	–	-40...+70	-40...+70	–
	Repeat accuracy		–	±2 %	±2 %	–
	Drift up to 0.5 million operating cycles		–	+15 %	+15 %	–
	Drift depending on ambient air temperature		–	0.25 % per °C	0.25 % per °C	–
Mechanical durability	In millions of operating cycles		30	5	5	30
Operational power of contacts			See page B8/70			

Characteristics - TeSys D, TeSys D Green

TeSys contactors

Auxiliary contact blocks with dust and damp protected contacts for TeSys D, TeSys D Green contactors

Environment							
Contact block type			LA1 DX	LA1 DZ		LA1 DY	
			Protected	Protected	Non protected	Protected	
Conforming to standards			IEC/EN 60947-5-1, UL 60947-5-1, CSA C22.2 n° 60947-5-1, GB/T 14048.5				
Product certifications			UL, CSA, CCC, EAC, CB certification				
Degree of protection	Conforming to IEC 60529		Protection against direct finger contact IP 2X				
Ambient air temperature	Storage and operation		°C	-25...+70			
Cabling	Phillips n° 2 and Ø6 mm Flexible or solid conductor with or without cable end		mm ²	Min: 1 x 1; max: 2 x 2.5			
Tightening torque			N.m	1.7			
Number of contacts			2	2	2	2	
Contact characteristics							
Rated operational voltage (Ue)	Up to		Vac	125	125	690	125
			Vdc	30	30		30
Rated insulation voltage (Ui)	Conforming to IEC 60947-5-1 Conforming to UL, CSA		V	250	250	690	250
			V	–	–	600	–
Conventional thermal current (Ith)	For ambient temperature ≤ 40 °C		A	–	–	10	–
Maximum operational current (Ie)			mA	100	100	–	100
Frequency of the operational current			Hz	–	–	25...400	–
Minimum switching capacity	U min I min		V	5	5	17	5
			mA	1	1	5	1
Short-circuit protection	Conforming to IEC 60947-5-1 gG fuse		A	–	–	10	–
Rated making capacity	Conforming to IEC 60947-5-1		I rms	A	–	–	~:140; ∞: 250
Short-time rating	Permissible for	1 s	A	–	–	100	–
		500 ms	A	–	–	120	–
		100 ms	A	–	–	140	–
Insulation resistance			MΩ	> 10	> 10	> 10	> 10
Mechanical durability			In millions of operating cycles	5	5	30	5
Materials and technology used for dust and damp protected contacts				Gold alloy - Single break	Gold alloy - Single break	–	Gold alloy - Single break with crossed bars

TeSys contactors

Auxiliary contact blocks without dust and damp protected contacts for TeSys D, TeSys D Green contactors

Rated operational power of contacts (conforming to IEC 60947-5-1)

a.c. supply, categories AC-14 and AC-15

Electrical durability (valid for up to 3600 operating cycles/hour) on an inductive load such as the coil of an electromagnet: making current ($\cos \phi 0.7$) = 10 times the power broken ($\cos \phi 0.4$).

Operating cycles	V	24	48	115	230	400	440	600
1 million	VA	60	120	280	560	960	1050	1440
3 million	VA	16	32	80	160	280	300	420
10 million	VA	4	8	20	40	70	80	100

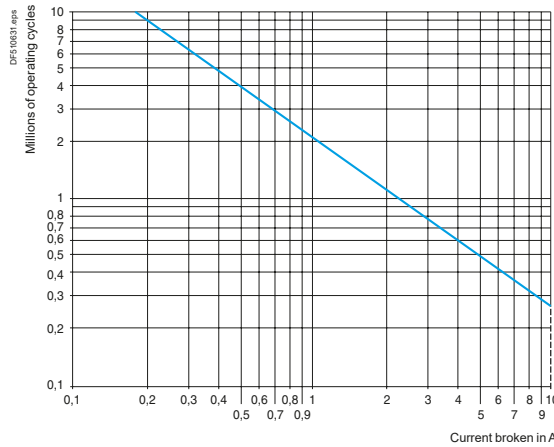

d.c. supply, category DC-13

Electrical durability (valid for up to 1200 operating cycles/hour) on an inductive load such as the coil of an electromagnet, without economy resistor, the time constant increasing with the load.

Operating cycles	V	24	48	125	250	440
1 million	W	96	76	76	76	44
3 million	W	48	38	38	32	—
10 million	W	14	12	12	—	—

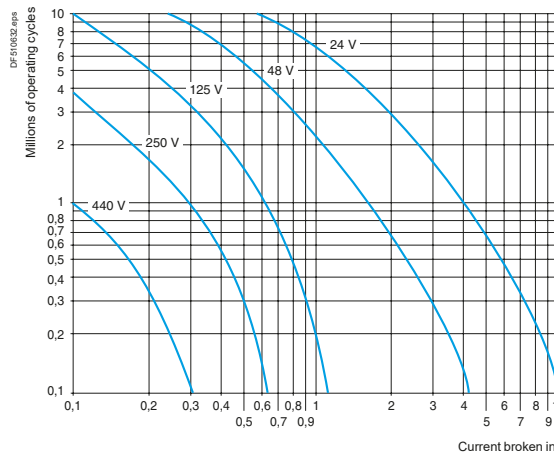

Characteristics - TeSys D, TeSys D Green

TeSys contactors

Control modules, coil suppressor modules and mechanical latch blocks for TeSys D, TeSys D Green contactors

Environment			
Conforming to standards			IEC/EN 60947-5-1, UL 60947-5-1, CSA C22.2 n° 60947-5-1, GB/T 14048.5
Product certifications			UL, CSA
Degree of protection	Conforming to IEC 60529		Protection against direct finger contact IP 2X
Ambient air temperature around the device	Storage	°C	-40...+80
	Operation	°C	-25...+55
	Permissible for operation at Uc	°C	-25...+70

Suppressor modules TeSys D						
Module type			LA4 DA, LAD 4RC, LAD 4RC3	LA4 DB, LAD 4T, LAD 4T3	LA4 DC, LAD 4D3	LA4 DE, LAD 4V, LAD 4V3
Type of protection			RC circuit	Bidirectional peak limiting diode	Diode	Varistor
Rated control circuit voltage (Uc)		V	~ 24...415	~ or --- 24...440	--- 12...250	~ or --- 24...250
Maximum peak voltage			3 Uc	2 Uc	Uc	2 Uc
Natural RC frequency	24/48 V	Hz	400	–	–	–
	50/127 V	Hz	200	–	–	–
	110/240 V	Hz	100	–	–	–
	380/415 V	Hz	150	–	–	–

Mechanical latch blocks ⁽¹⁾ TeSys D, TeSys D Green					
Mechanical latch block type			LAD 6K10	LA6 DK20	
For use on contactor			LC1 D09...D80A DT20...DT80A	LC1 D80...D150 LP1 D80 and LC1 D115	
Product certifications			UL, CSA	UL, CSA	
Rated insulation voltage	Conforming to IEC 60947-5-1	V	690	690	
Rated control circuit voltage	~ 50/60 Hz and ---	V	24...415	24...415	
Power required	For unlatching	~	VA	25	
		---	W	30	
Maximum operating rate	In operating cycles/hour		1200	1200	
On-load factor			10 %	10 %	
Mechanical durability at Uc	In millions of operating cycles		0.5	0.5	

⁽¹⁾ Unlatching can be manually operated or electrically controlled (pulsed).

The LA6 DK or LAD 6K latch coil and the LC1 D operating coil must not be energised simultaneously.

The duration of the LA6 DK or LAD 6K and LC1 D control signals must be ≥ 100 ms.

TeSys contactors

Electronic serial timer module for TeSys D, TeSys D Green contactors

Environment TeSys D, TeSys D Green			
Module type		LA4 DT (On-delay)	
Conforming to standards			IEC 60255-5
Product certifications			UL, CSA
Degree of protection	Conforming to IEC 60529		Protection against direct finger contact IP 2X
Ambient air temperature around the device	Storage	°C	-40...+80
	Operation	°C	-25...+55
	For operation at U _c	°C	-25...+70
Rated insulation voltage (U _i)	Conforming to IEC 60947-1	V	250
Cabling	Phillips n° 2 and Ø6 mm Flexible or solid conductor with or without cable end	mm ²	Min: 1 x 1; max: 2 x 2.5
Tightening torque		N.m	1.7

Control circuit characteristics			
Built-in protection	Of the input		By varistor
	Contactors coil suppression		By varistor
Rated control circuit voltage (U _c)		V	~ or ≡: 24...250
Permissible variation			0.8...1.1 U _c
Type of control			By mechanical contact only

Timing characteristics			
Timing ranges		s	0.1...2; 1.5...30; 25...500
Repeat accuracy	0...40 °C		±3 % (10 ms minimum)
Reset time	During time delay period	ms	150
	After time delay period	ms	50
Immunity to microbreaks	During time delay period	ms	10
	After time delay period	ms	2
Minimum control pulse duration		ms	–
Time delay signalling	By LED		Illuminates during time delay period

Switching characteristics (solid state type)			
Maximum power dissipated		W	2
Leakage current		mA	< 5
Residual voltage		V	3.3
Overvoltage protection			3 kV; 0.5 joule
Electrical durability	In millions of operating cycles		30

Function diagram

Electronic on-delay timer LA4 DT

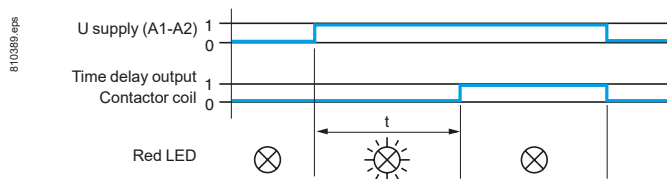

TeSys contactors

Interface modules for TeSys D, TeSys D Green contactors

Environment TeSys D, TeSys D Green			
Conforming to standards			IEC 60255-5
Product certifications			UL, CSA
Degree of protection	Conforming to IEC 60529		Protection against direct finger contact IP 2X
Ambient air temperature around the device	Storage	°C	-40...+80
	Operation	°C	-25...+55
	Permissible for operation at Uc	°C	-25...+70

Other characteristics

Module type			LA4 DFB for TeSys D With relay	LA4 DWB for TeSys D, TeSys D Green Solid state		
Conventional thermal current (Ith)	For ambient temperature ≤ 50 °C	A	8			
Rated insulation voltage	Conforming to IEC 60947-5-1	V	250			
Rated operational voltage	Conforming to IEC 60947-5-1	V	250			
Indication of input state			By integral LED which illuminates when the contactor coil is energised			
Input signals	Control voltage (E1-E2)	V	~ 24	~ 24		
	Permissible variation	V	17...30	5...30		
	Current consumption at 20 °C	mA	25	8.5 for 5 V 15 for 24 V		
	State "0" guaranteed for U	V	< 2.4	< 2.4		
	I	mA	< 2	< 2		
	State "1" guaranteed for U	V	17	5		
Built-in protection	Against reversed polarity		By diode	By diode		
	Of the input		By diode	By diode		
Electrical durability at 220 A/240 V	In millions of operating cycles		10	20		
Maximum immunity to microbreaks		ms	4	1		
Power dissipated	At 20 °C	W	0.6	0.4		
Direct mounting on contactor	With coil	~ 24...250 V	LC1 D80...D150	–		
		~ 100...250 V	–	LC1 D80...D115		
		~ 380...415 V	–	–		
Mounting with cabling adapter LAD 4BB	With coil	~ 24...250 V	LC1 D09...D38, LC1 DT20...DT40	LC1 D09...D38, LC1 DT20...DT40		
		~ 380...415 V	–	–		
Mounting with cabling adapter LAD 4BB3	With coil	~ 24...250 V	LC1 D40A...D80A	LC1 D40A...D80A		
		~ 380...415 V	LC1 D40A...D80A	LC1 D40A...D80A		
Total operating time at Uc (of the contactor)	The operating times depend on the type of contactor electromagnet and its control mode. The closing time "C" is measured from the moment the coil supply is switched on to initial contact of the main poles. The opening time "O" is measured from the moment the coil supply is switched off to the moment the main poles separate.					
			LC1 D09...D38, LC1 DT20...DT40	LC1 D40A...D80A	LC1 D80 and D95	
	With LA4 DFB	"C"	ms	20...30	28...34	28...43
		"O"	ms	16...24	20...24	18...32
Cabling	Phillips n° 2 and Ø6 mm Flexible or solid cable with or without cable end	mm²	Min: 1 x 1; max: 2 x 2.5			
Tightening torque		N.m	1.7			

Dimensions - TeSys D

TeSys contactors

TeSys D contactors

Control circuit: a.c.

LC1 D09...D18 (3-pole)

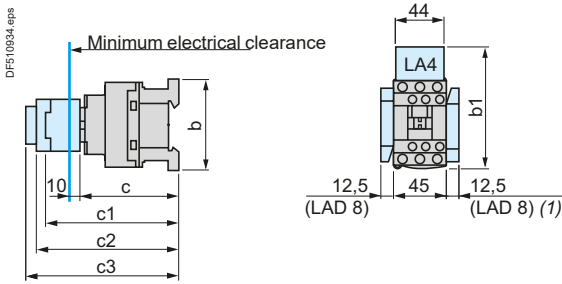

LC1 D25...D38 (3-pole), LC1 DT20...DT40 (4-pole)

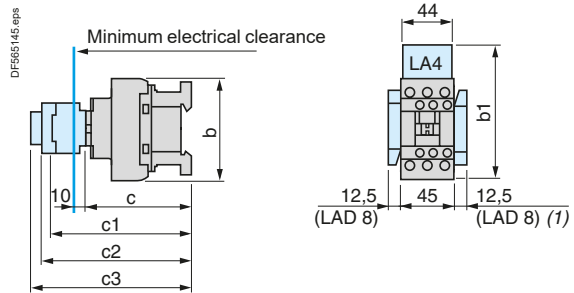

LC1	D09...D18	D093... D123	D099... D129	D25... D38	D183... D323	D098, D128, DT20 and DT25	DT203 and DT253	DT32 and DT40	D188, D258, DT323 and DT403
b without add-on blocks	77	99	80	85	99	85	99	91	105
b1 with LAD 4BB	94	107	95,5	98	107	98	-	-	-
with LA4 D●2	110 ⁽¹⁾	123 ⁽¹⁾	111,5 ⁽¹⁾	114 ⁽¹⁾	123 ⁽¹⁾	114	-	-	-
with LA4 DF, DT	119 ⁽¹⁾	132 ⁽¹⁾	120,5 ⁽¹⁾	123 ⁽¹⁾	132 ⁽¹⁾	129	-	-	-
with LA4 DW, DL	126 ⁽¹⁾	139 ⁽¹⁾	127,5 ⁽¹⁾	130 ⁽¹⁾	139 ⁽¹⁾	190	-	-	-
c without cover or add-on blocks	84	84	84	90	90	90	90	97	97
with cover, without add-on blocks	86	86	86	92	92	92	92	99	99
c1 with LAD N or C (2 or 4 contacts)	117	117	117	123	123	123	123	131	131
c2 with LA6 DK10, LAD 6K10	129	129	129	135	135	135	135	143	143
c3 with LAD T, R, S	137	137	137	143	143	143	143	151	151
with LAD T, R, S and sealing cover	141	141	141	147	147	147	147	155	155

⁽¹⁾ Including LAD 4BB.

LC1 D40A...D80A (3-pole), LC1 DT60A...DT80A (4-pole)

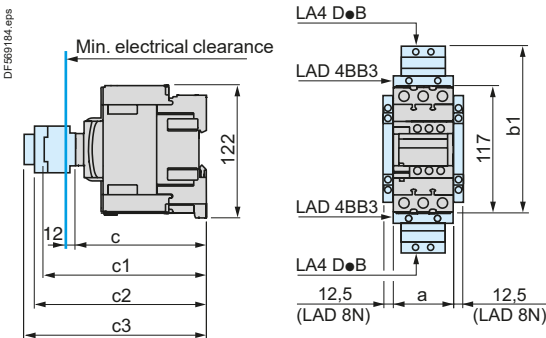

LC1 D80 and D95 (3-pole), LC1 D80004 and D80008 (4-pole), D40008 and D65008 (4-pole)

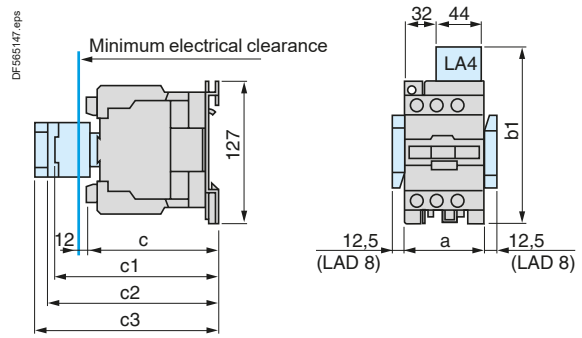

LC1	D40A...D80A	DT60A...DT80A	D40008	D80	D95, D65008	D80004	D80008
a	55	70	85	85	85	96	96
b1 with LA4 D●2	-	-	135	135	135	135	135
with LA4 DB3 or LAD 4BB3	136	-	-	135	-	-	-
with LA4 DF, DT	157	-	142	142	142	142	142
with LA4 DM, DW, DL	166	-	150	150	150	150	150
c without cover or add-on blocks	118	118	125	125	125	125	140
with cover, without add-on blocks	120	120	-	130	130	-	-
c1 with LAD N (1 contact)	-	-	139	150	150	150	150
with LAD N or C (2 or 4 contacts)	150	150	147	158	158	158	158
c2 with LAD 6K10 or LA6 DK	163	163	159	170	170	170	170
c3 with LAD T, R, S	171	171	167	178	178	178	178
with LAD T, R, S and sealing cover	175	175	171	182	182	182	182

LC1 D115 and D150 (3-pole), LC1 D115004 (4-pole)

LC1	D115, D150	D115004	D1150046
a	120	150	155
b1 with LA4 DA2	174	174	174
with LA4 DF, DT	185	185	185
with LA4 DM, DL	188	188	188
with LA4 DW	188	188	188
c without cover or add-on blocks	132	132	115
with cover, without add-on blocks	136	-	-
c1 with LAD N or C (2 or 4 contacts)	150	150	150
c2 with LA6 DK20	155	155	155
c3 with LAD T, R, S	168	168	168
with LAD T, R, S and sealing cover	172	172	172

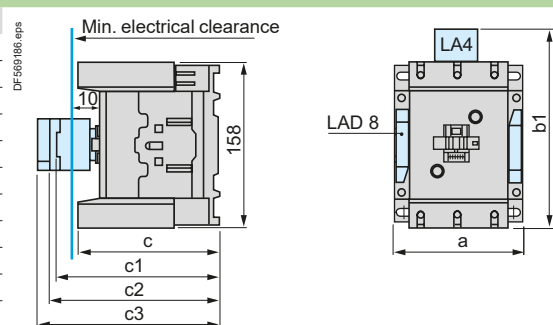

Dimensions - TeSys D

TeSys contactors

TeSys D contactors

Control circuit: d.c. or low consumption

LC1 D09...D18 (3-pole)

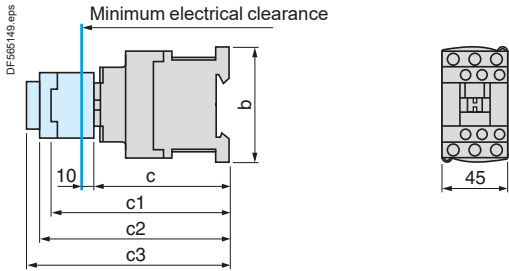

LC1 D25...D38 (3-pole)

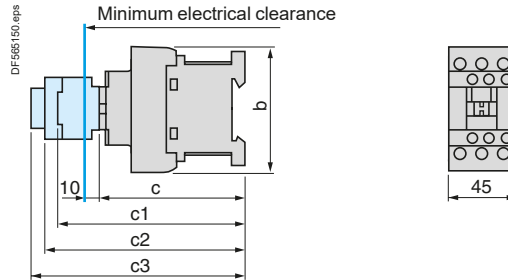

LC1	D09...D18	D093...D123	D099...D129	D25...D38	D183...D323
b	77	99	80	85	99
c without cover or add-on blocks	93	93	93	99	99
with cover, without add-on blocks	95	95	95	101	101
c1 with LAD N or C (2 or 4 contacts)	126	126	126	132	132
c2 with LA6 DK10	138	138	138	144	144
c3 with LAD T, R, S	146	146	146	152	152
with LAD T, R, S and sealing cover	150	150	150	156	156

LC1 DT20...DT40 (4-pole)

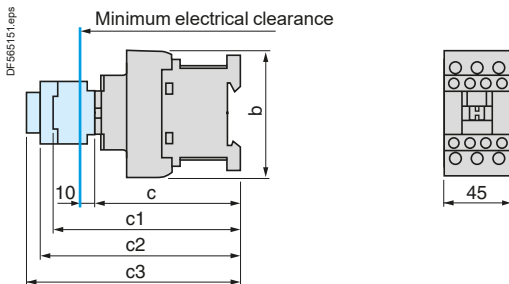

LC1	DT20 and DT25 D098 and D128	DT203 and DT253 D0983 and D1283	DT32 and DT40 D188...D258	DT323 and DT403 D1883 and D2583
b	85	99	91	105
c with cover	102	102	107	107
c1 with LAD N or C (2 or 4 contacts)	123	123	131	131
c2 with LA6 DK10	135	135	143	143
c3 with LAD T, R, S	143	143	151	151
with LAD T, R, S and sealing cover	147	147	155	155

LC1 D40A...D80A (3-pole), LC1 DT60A...DT80A (4-pole)

LC1 D80 and D95 (3-pole), LP1 D80004, LP1 D80008 (4-pole), LP1 D40008 and D65008 (4-pole)

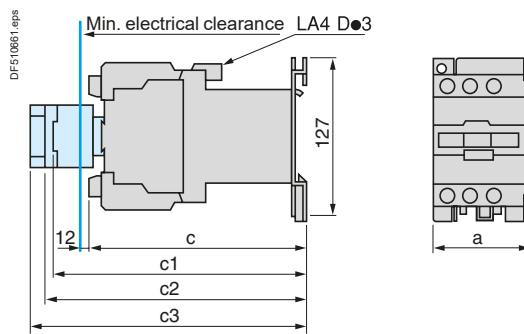
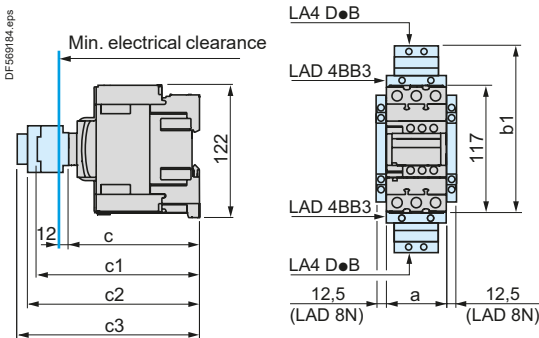

	LC1 D40A ... D80A	LC1 DT60A...DT80A	LP1 D40008 and D65008	LC1 D80 and D95	LP1 D80004	LP1 D80008
a	55	72	85	85	96	96
b1 with LAD 4BB3	136	136	-	-	-	-
with LA4 DF, DT	157	157	-	-	-	-
c without cover or add-on blocks	118	118	182	181	181	196
with cover, without add-on blocks	120	120	-	186	-	-
c1 with LAD N (1 contact)	-	-	196	204	204	204
with LAD N or C (2 or 4 contacts)	150	150	202	210	210	210
c2 with LA6 DK10	163	163	213	221	221	221
c3 with LAD T, R, S	171	171	221	229	229	229
with LAD T, R, S and sealing cover	175	175	225	233	233	233

LC1 D115●●● and LC1 D150●●● with ∴ coil: see page B8/74.

Mounting - TeSys D

TeSys contactors

TeSys D contactors

LC1 D09...D38, DT20...DT40

On mounting rail AM1 DP200, DR200 or AM1 DE200 (width 35 mm)

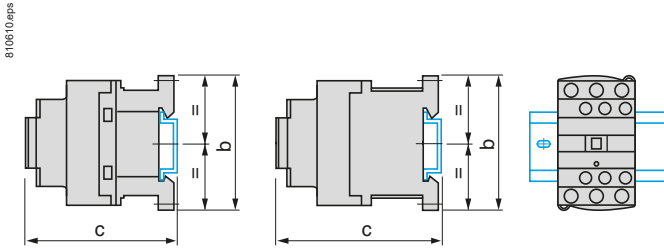

LC1 D40A...D80A, LC1 DT60A and DT80A, LC1 D80 and D95, LC1 D40008 and D65008

On mounting rail AM1 DL200 or DL201 (width 75 mm) ⁽²⁾
On mounting rail AM1 ED●●● or AM1 DE200 (width 35 mm)

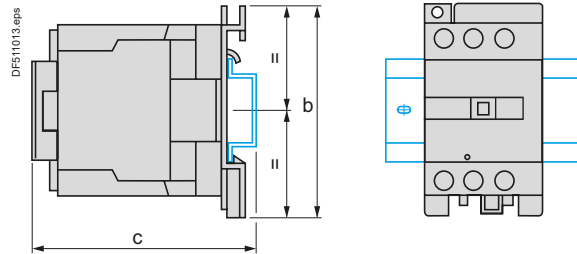

Control circuit: a.c.

LC1	D09... D18	D25... D38	DT20 and DT25	DT32 and DT40
b	77	85	85	100
c (AM1 DP200 or DR200) ⁽¹⁾	88	94	94	109
c (AM1 DE200) ⁽¹⁾	96	102	102	117

Control circuit: a.c.

LC1	D40A...D80A DT60A...DT80A	D80 and D95	D40008 and D65008
b	122	127	127
c (AM1 DL200) ⁽¹⁾	–	147	143
c (AM1 DL201) ⁽¹⁾	–	137	133
c (AM1 ED●●● or DE200) ⁽¹⁾	128	137	133

Control circuit: d.c.

LC1	D09... D18	D25... D38	DT20 and DT25	DT32 and DT40
b	77	85	94	109
c (AM1 DP200 or DR200) ⁽¹⁾	97	103	103	118
c (AM1 DE200) ⁽¹⁾	105	110	111	126

Control circuit: d.c.

LC1	D40A...D80A DT60A...DT80A	D80 and D95	D40008 and D65008
c (AM1 DL200) ⁽¹⁾	–	205	200
c (AM1 DL201) ⁽¹⁾	–	195	190
c (AM1 ED●●● or DE200) ⁽¹⁾	128	–	190

⁽¹⁾ With safety cover.

⁽¹⁾ With safety cover.

⁽²⁾ Except for LC1 D40A...D80A, LC1 DT60A and DT80A.

LC1 D80 and D95, LP1 D80

On 2 mounting rails DZ5 MB on 120 mm centres

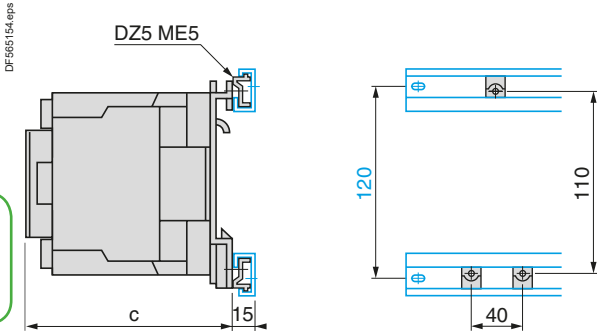

Control circuit: a.c.

LC1	D80 and D95
c with cover	130

Control circuit: d.c.

LC1	D80 and D95
c with cover	186

LP1	D80
c	181

LC1 D115, D150

On 2 mounting rails DZ5 MB on 120 mm centres

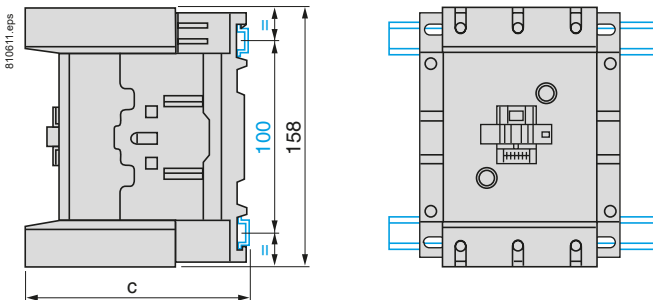

Control circuit: a.c. or d.c.

LC1	D115 and D150	D1156 and D1506
c (AM1 DP200 or DR200)	134.5	117.5
c (AM1 DE200 or ED●●●)	142.5	125.5

Mounting - TeSys D

TeSys contactors

TeSys D contactors

LC1 D09...D38 and LC1 DT20...DT40

On 2 mounting rails DZ5 MB

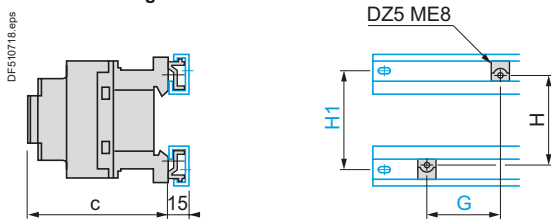

Control circuit:	a.c.		d.c.	
	D09...D18	D25...D38	D09...D18	D25...D38
LC1				
c with cover	86	92	95	101
G	35	35	35	35
H	60	60	70	70
H1	70	70	70	70

4-pole contactors

LC1	DT20 and DT25	DT32 and DT40	DT20 and DT25	DT32 and DT40
	c with cover	92	100	101
G	35	35	35	35
H	60	60	70	70
H1	70	70	70	70

LC1 D09...D38 and LC1 DT20...DT40

On pre-slotted mounting plate AM1 PA, PB, PC

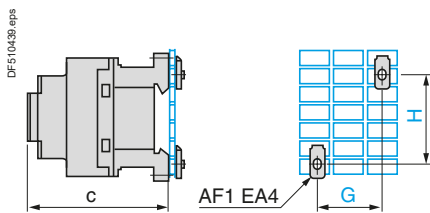

LC1 D40A...D80A, LC1 DT60A...DT80A

On pre-slotted mounting plate AM1 PA, PB, PC and panel mounted

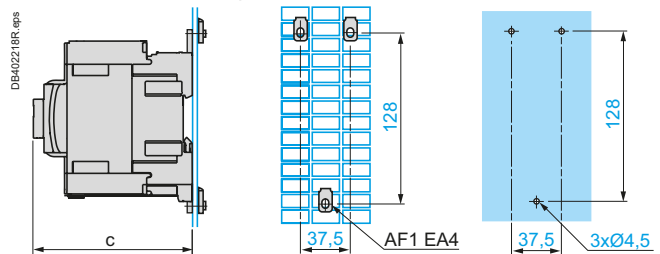

Control circuit:	a.c.		d.c.	
	D09...D18	D25...D38	D09...D18	D25...D38
LC1				
c with cover	86	92	95	101
G	35	35	35	35
H	60/70	60/70	70	70
LC1	DT20 and DT25	DT32 and DT40	DT20 and DT25	DT32 and DT40
c with cover	80	93	118	132
G	35	35	35	35
H	60	60	70	70

Control circuit:	a.c.		d.c.	
	D40A...D80A, DT60A...DT80A		D40A...65A, DT60A...DT80A	
LC1				
c with cover	120		120	

LC1 D09...D38, LC1 DT20...DT40

Panel mounted

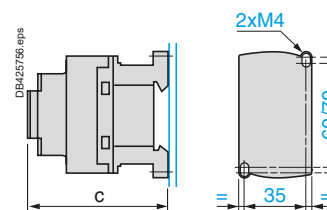

LC1 D80 and D95, LC1 D40008 and D65008, LP1 D80

On pre-slotted mounting plate AM1 PA, PB, PC and panel mounted

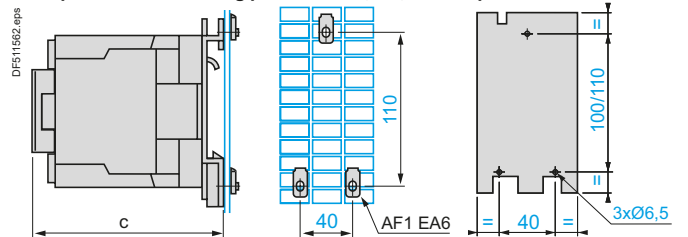

Control circuit:	a.c.		d.c.	
	D09...D18	D25...D38	D09...D18	D25...D38
LC1				
c with cover	86	92	95	101
4-pole contactors				
LC1	DT20 and DT25	DT32 and DT40	DT20 and DT25	DT32 and DT40
c with cover	90	98	90	98

Control circuit:	a.c.		d.c.	
	D80 and D95, D40008 and D65008		D80 and D95, D40008 and D65008	
LC1				
c with cover	130		186	
LP1	-	-	D80	
c without cover	-	-	181	

LC1 D115, D150

Panel mounted

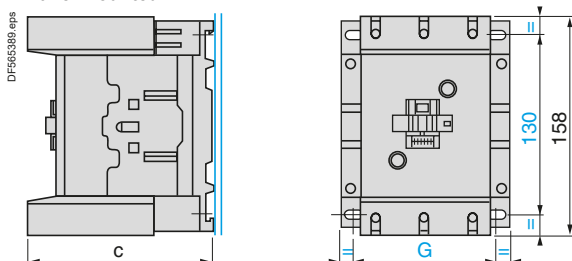

LC1	D115	D1156	D150	D1506
c	132	115	132	115
G (3-pole)	96/110	96/110	96/110	96/110
G (4-pole)	130/144	130/144	-	-

Selection: pages A6/25 to A6/49

Characteristics: pages B8/61 to B8/73

References: pages B8/2 to B8/5

Schemes: pages B8/81 to B8/82

Dimensions

TeSys D Green

Contactors with AC/DC coil

LC1 D09...D18 (3-pole), with AC/DC compatible coil

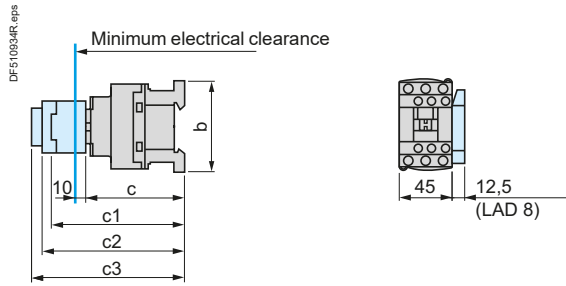

LC1 D25...D38 (3-pole), with AC/DC compatible coil

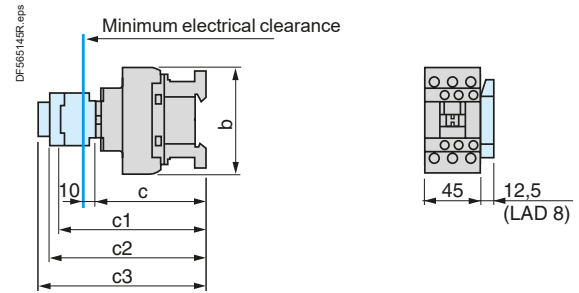

LC1	D09...D18	D25...D38
b without add-on blocks	77	85
c without cover or add-on blocks	84	90
with cover, without add-on blocks	86	92
c1 with LAD N or C (2 or 4 contacts)	117	123
c2 with LA6 DK10	129	135
c3 with LAD T, R, S	137	143
with LAD T, R, S and sealing cover	141	147

LC1 D40A...D80A (3-pole), LC1 DT60A...DT80A (4-pole), with AC/DC compatible coil

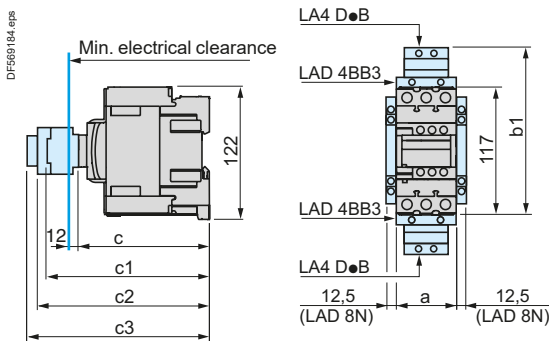

LC1	D40A...D80A	DT60A...DT80A
a	55	70
b1 LAD 4BB3	136	-
with LAD4DWB	166	-
c without cover or add-on blocks	118	118
with cover, without add-on blocks	120	120
c1 with LAD N (1 contact)	-	-
with LAD N or C (2 or 4 contacts)	150	150
c2 with LAD 6K10	163	163
c3 with LAD T, R, S	171	171
with LAD T, R, S and sealing cover	175	175

Mounting

TeSys D Green

Contactors with AC/DC coil

**LC1 D09...D38 (3-pole),
with AC/DC compatible coil**

On mounting rail **AM1 DP200, DR200 or AM1 DE200** (width 35 mm)

810610.eps

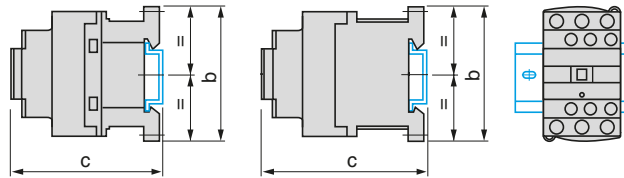

**LC1 D40A...D80A (3-pole), LC1 DT60A and DT80A (4-pole),
with AC/DC compatible coil**

On mounting rail **AM1 DL200 or DL201** (width 75 mm) ⁽²⁾
On mounting rail **AM1 ED●●● or AM1 DE200** (width 35 mm)

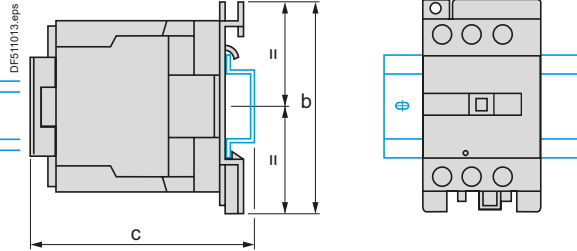

LC1	D09...D18	D25...D38
b	77	85
c (AM1 DP200 or DR200)	88	94
c (AM1 DE200)	96	102

LC1	D40A...D80A DT60A...DT80A
b	122
c (AM1 DL200)	—
c (AM1 DL201)	—
c (AM1 ED●●● or DE200)	128

Mounting

TeSys D Green

Contactors with AC/DC coil

LC1 D09...D38 (3-pole), with AC/DC compatible coil

On 2 mounting rails DZ5 MB

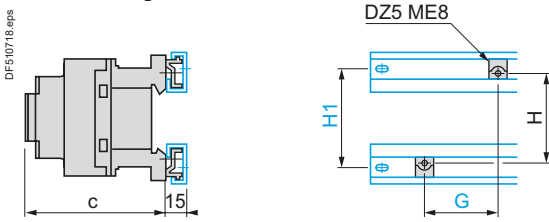

LC1	D09...D18	D25...D38
c with cover	86	92
G	35	35
H	60	60
H1	70	70

LC1 D09...D38 (3-pole), with AC/DC compatible coil

On pre-slotted mounting plate AM1 PA, PB, PC

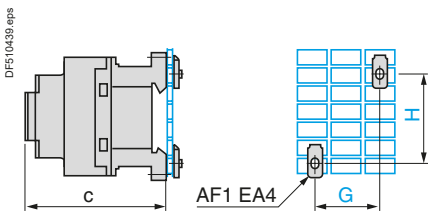

LC1	D09...D18	D25...D38
c with cover	86	92
G	35	35
H	60/70	60/70

LC1 D40A...D80A (3-pole), LC1 DT60A...DT80A (4-pole), with AC/DC compatible coil

On pre-slotted mounting plate AM1 PA, PB, PC and panel mounted

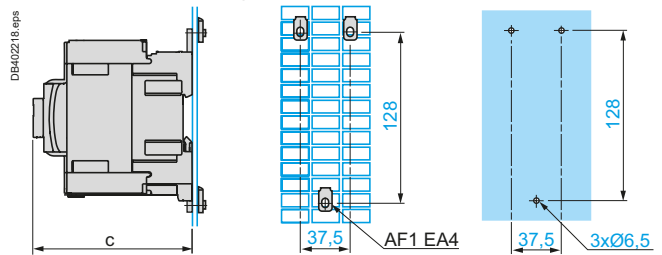

LC1	D40A...D80A, DT60A...DT80A
c with cover	120

LC1 D09...D38 (3-pole), with AC/DC compatible coil

Panel mounted

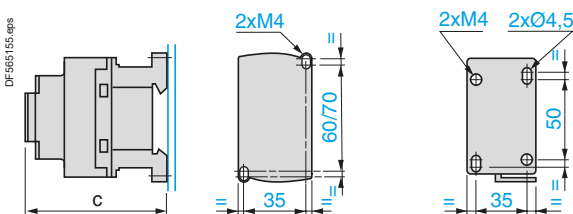

LC1	D09...D18	D25...D38
c with cover	86	92

TeSys contactors

TeSys D, TeSys D Green contactors

Contactors

TeSys D, TeSys D Green 3-pole contactors (References: pages B8/2 to B8/5)

LC1 D09 to D150

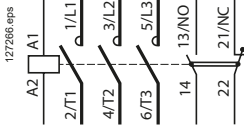

TeSys D 4-pole contactors (References: pages B8/6 and B8/7)

LC1 DT20 to DT80A

LC1 D115004

LC1 D098 to D258

LC1 and LP1 D4008 to D80008

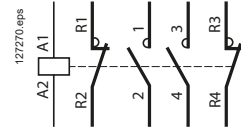
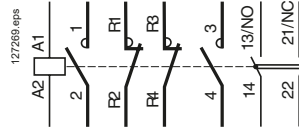
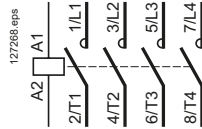
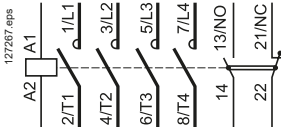

Front mounting add-on contact blocks

Instantaneous auxiliary contacts for TeSys D, TeSys D Green (References: page B8/23)

1 N/O LAD N10 ⁽¹⁾

1 N/C LAD N01 ⁽¹⁾

1 N/O + 1 N/C LAD N11

2 N/O LAD N20

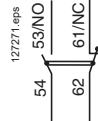
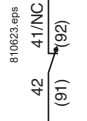
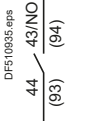

2 N/C LAD N02

2 N/O + 2 N/C LAD N22

1 N/O + 3 N/C LAD N13

4 N/O LAD N40

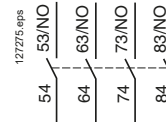
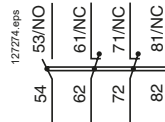
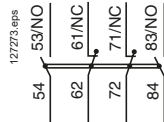

4 N/C LAD N04

2 N/O + 2 N/C including 1 N/O + 1 N/C make before break LAD C22

3 N/O + 1 N/C LAD N31

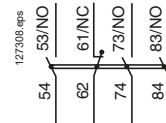
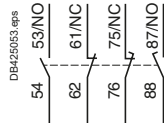
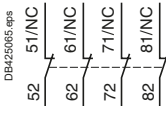

Instantaneous auxiliary contacts conforming to standard EN 50012 for TeSys D, TeSys D Green (References: page B8/23)

1 N/O + 1 N/C LAD N11G

1 N/O + 1 N/C LAD N11P

2 N/O + 2 N/C LAD N22G

2 N/O + 2 N/C LAD N22P

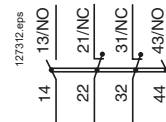
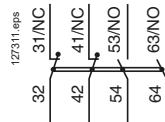
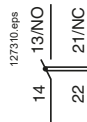
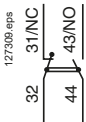

3 N/O + 1 N/C LAD N31G

3 N/O + 1 N/C LAD N31P

1 N/O + 3 N/C LAD N13G

1 N/O + 3 N/C LAD N13P

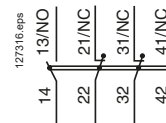
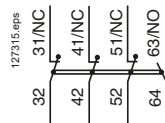
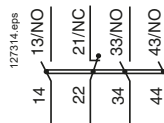
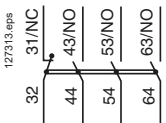

(1) Items in brackets refer to blocks mounted on right-hand side of contactor.

TeSys contactors

TeSys D, TeSys D Green contactors

Front mounting add-on contact blocks for TeSys D, TeSys D Green

Dust and damp protected instantaneous auxiliary contacts (References: page B8/23)

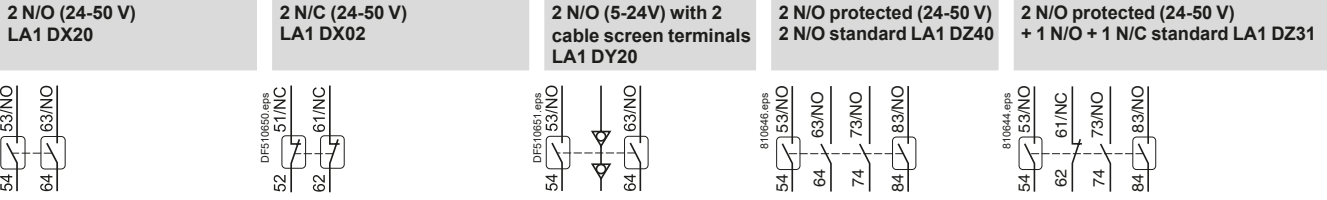

Time delay auxiliary contacts (References: page B8/24)



Mechanical latch blocks for TeSys D, TeSys D Green (References: page B8/24)

LAD 6K10 and LA6 DK20

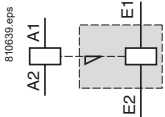

Side mounting add-on contact blocks for TeSys D, TeSys D Green

Instantaneous auxiliary contacts (References: page B8/23)

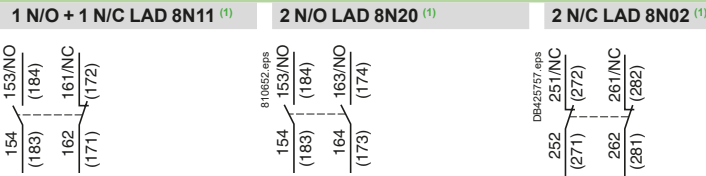

⁽¹⁾ Items in brackets refer to blocks mounted on right-hand side of contactor.

Electronic serial timer modules for TeSys D, TeSys D Green

On-delay LA4 DT●U

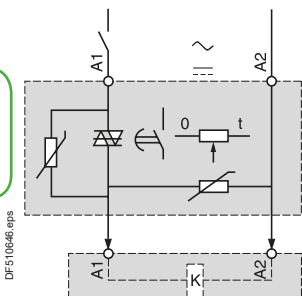

Contactors

Interface modules

Relay output for TeSys D
LA4 DFB

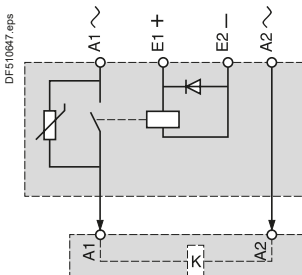

Solid state for TeSys D, TeSys D Green
LA4 DWB

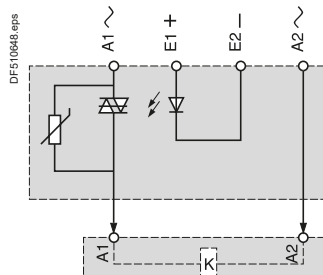

References: page B8/85.

Selection:
pages A6/25 to A6/49

Characteristics:
pages B8/61 to B8/73

References:
pages B8/2 to B8/27

Dimensions:
pages B8/74 and B8/75

Dimensions - TeSys D, TeSys D Green

TeSys contactors

TeSys D, TeSys D Green reversing and changeover contactors

LC2 D09 to D38 TeSys D, TeSys D Green

2 x LC1 D09 to D38

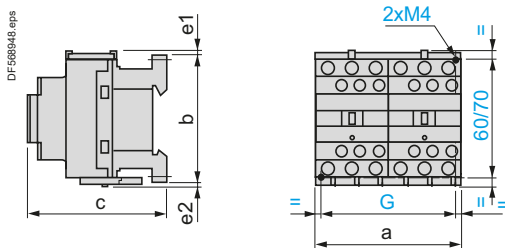

LC2 or 2 x LC1	a	b	c ⁽¹⁾	e1	e2	G
D09 to D18 AC, AC/DC	90	77	86	4	1.5	80
D093 to D123 AC	90	99	86	–	–	80
D09 to D18 DC	90	77	95	4	1.5	80
D093 to D123 DC	90	99	95	–	–	80
D25 to D38 AC, AC/DC	90	85	92	9	5	80
D183 to D383 AC	90	99	92	–	–	80
D25 to D32 DC	90	85	101	9	5	80
D183 to D383 DC	90	99	101	–	–	80

e1 and e2: including cabling.

(1) With safety cover, without add-on block.

LC2 DT20 to DT40 TeSys D

2 x LC1 DT20 to DT40

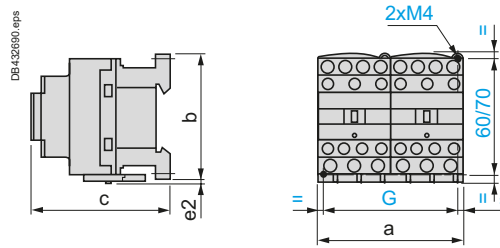

LC2 or 2 x LC1	a	b	c	G	e2
DT20 and DT25 AC	90	85	92	80	20
DT32 and DT40 AC	90	91	99	80	22
DT20 and DT25 DC	90	85	102	80	20
DT32 and DT40 DC	90	91	109	80	22

c, e: including cabling.

LC2 D40A to D80A for TeSys D, TeSys D Green

2 x LC1 D40A to D80A

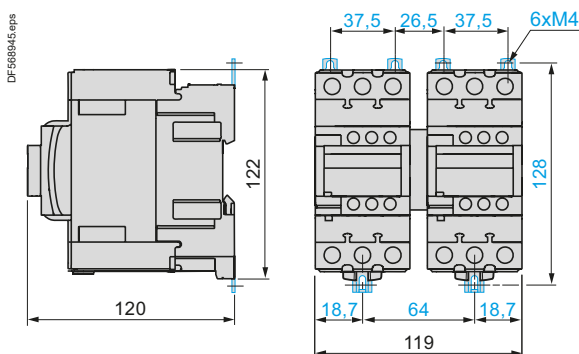

Dimensions - TeSys D

TeSys contactors

TeSys D reversing and changeover contactors

LC2 D80 and D95

2 x LC1 D80 and D95 ~

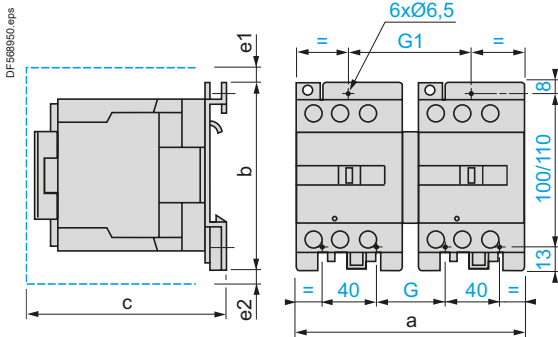

LC2 or 2 x LC1	a	b	c	e1	e2	G	G1
D80 and D95 ~	182	127	158	13	-	57	96
D80004 ~	207	127	158	-	20	71	111

c, e1 and e2: including cabling.

2 x LC1 D80 and D95 ---

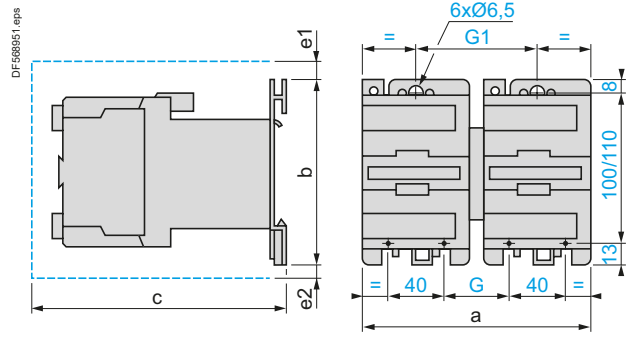

2 x LC1	a	b	c	e1	e2	G	G1
D80 and D95	207	127	215	13	20	96	111

c, e1 and e2: including cabling.

LC2 D115 and D150

2 x LC1 D115 and D150

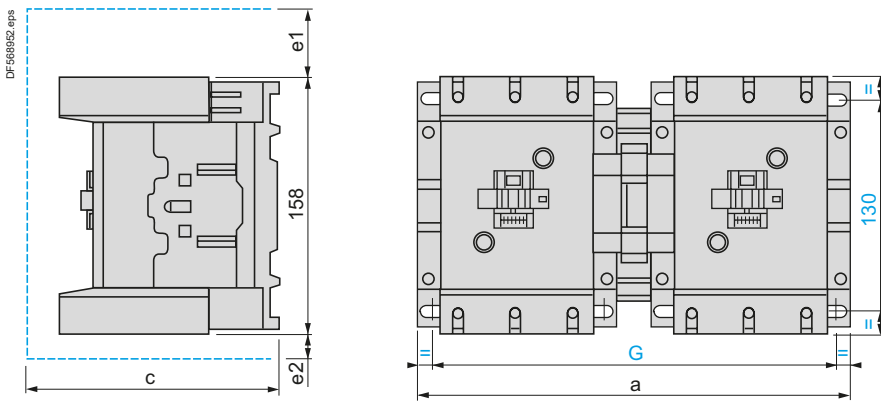

LC2 or 2 x LC1	a	c	e1	e2	G
D115 and D150	266	148	56	18	242/256
D115004	334	148	-	60	310/324

c, e1 and e2: including cabling.

TeSys contactors

TeSys D, TeSys D Green reversing and changeover contactors

Reversing contactors for motor control

LC2 D09...D80A TeSys D , TeSys D Green LC2D80...D150 TeSys D

Horizontally mounted

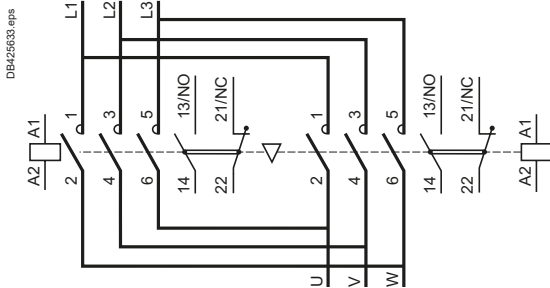

LAD 9R1V TeSys D, TeSys D Green

With integral electrical interlocking

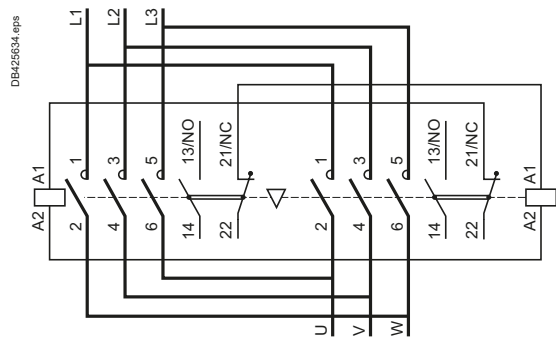

Changeover contactor pairs TeSys D

LC2 DT20...DT40

Horizontally mounted

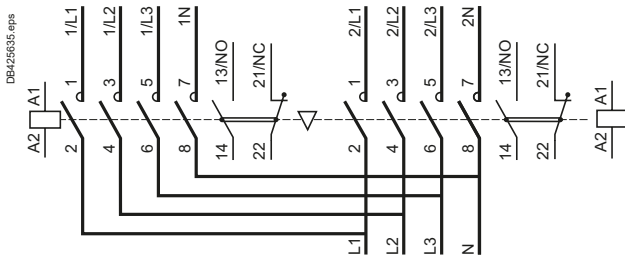

LAD T9R1V

With integral electrical interlocking

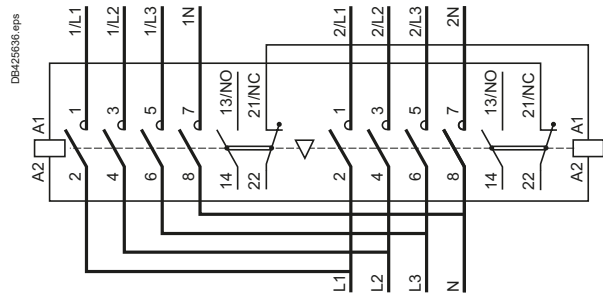

TeSys contactors

TeSys D, TeSys D Green reversing and changeover contactors

Electrical interlocking of TeSys D, TeSys D Green reversing contactors fitted with:

Mechanical interlock with integral electrical contacts
 LA9 D4002, LA9 D8002 and LA9 D11502

Mechanical interlock without integral electrical contacts
 LAD 9V2, LAD 4CM, LA9 D50978 and LA9 D80978

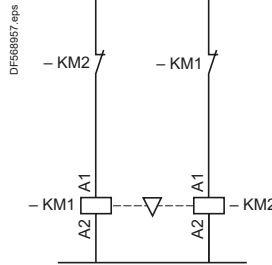
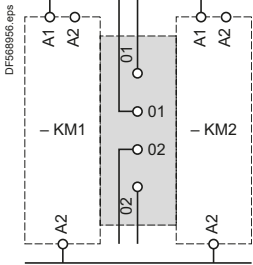

Low speed - High speed cabling kit, screw clamp terminals for LC1D09... D38 contactors (TeSys D, TeSys D Green)

Low speed - High speed cabling kit, spring terminals for LC1D09... D38 contactors (TeSys D)

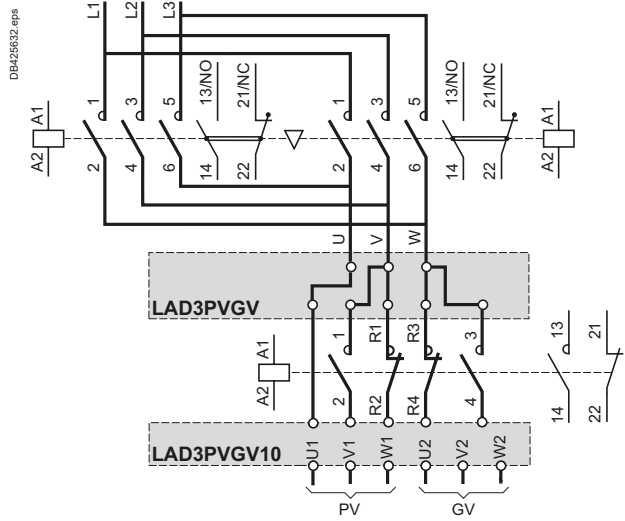
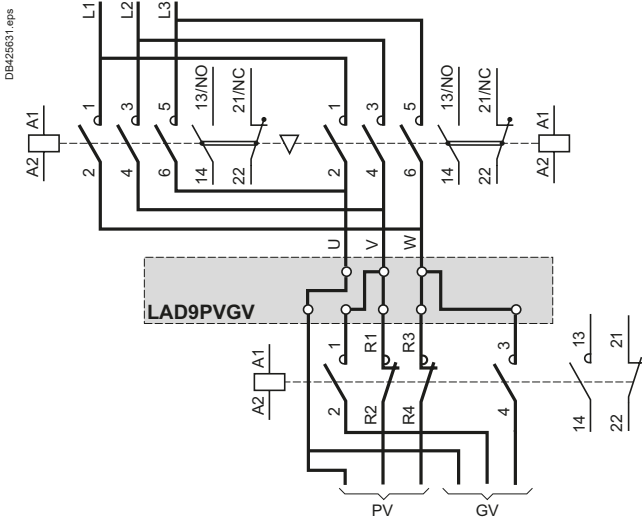

TeSys contactors

For switching 3-phase capacitor banks, used for power factor correction

Dimensions

LC1 DFK

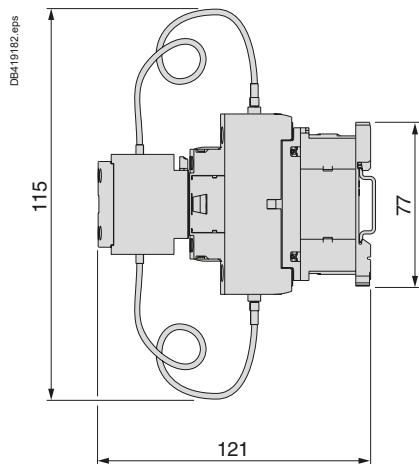

LC1 DGK, DLK, DMK

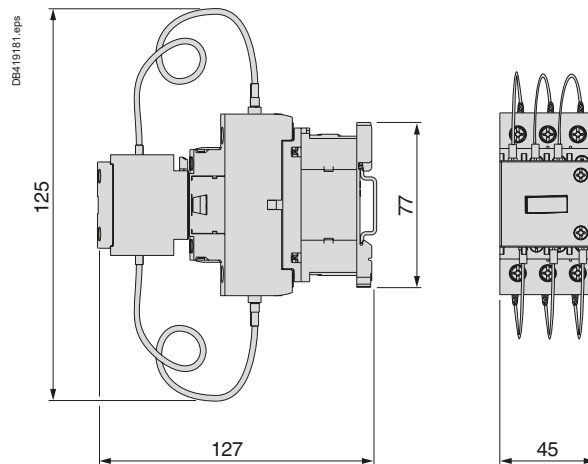

LC1 DPK, DTK

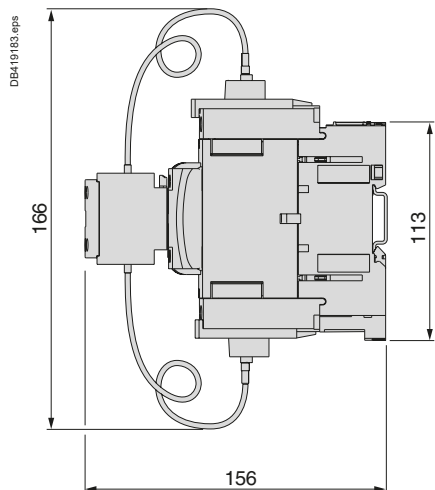

LC1 DWK

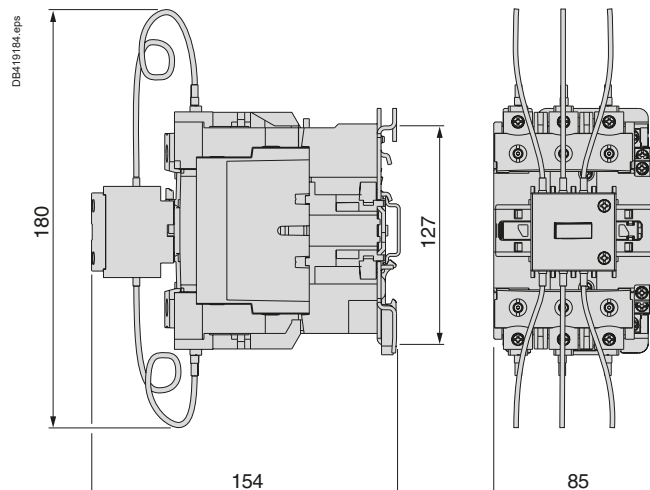

Schemes

LC1 D•K

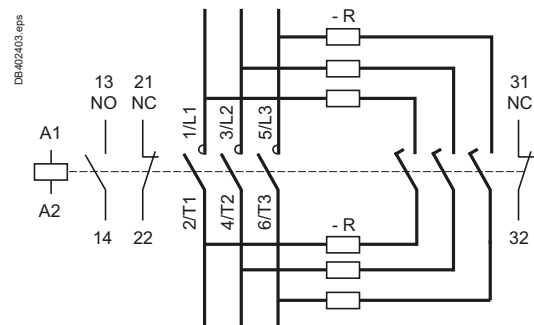

R = Pre-wired resistor connections.

TeSys contactors

Mini-contactors TeSys LC1 SK and LP1 SK

Environment			
Rated insulation voltage (Ui)	Conforming to 60947	V	690
Conforming to standards			IEC/EN 60947-4-1, UL 60947-4-1, CSA C22.2 n° 60947-4-1
Approvals			cULus, CCC, EAC, CB certification
Degree of protection	Conforming to IEC 60529		Protection against direct finger contact IP2x
Ambient air temperature around the device	Storage	°C	-50...+70
	Operation	°C	-20...+50
Maximum operating altitude	Without derating	m	2000
Operating position			<div style="display: flex; justify-content: space-around;"> <div style="text-align: center;"> <p>Vertical axis</p> <p>Without derating</p> </div> <div style="text-align: center;"> <p>Horizontal axis</p> <p>Without derating</p> </div> </div>
Cabling, screw clamp terminals			Min Max
	Solid conductor	mm²	1 x 1.5 or 2 x 1.5 1 x 6 or 2 x 4
	Flexible cable without cable end	mm²	1 x 0.5 or 2 x 0.35 1 x 6 or 2 x 2.5
	Flexible cable with cable end	mm²	1 x 0.35 or 2 x 0.35 1 x 6 or 2 x 1.5
Tightening torque	Pozidriv n° 1 head	N.m	0.8
Terminal referencing			Conforming to standards En 50005

TeSys contactors

Mini-contactors TeSys LC1 SK and LP1 SK

Pole characteristics			
Conventional thermal current (I _{th})	For ambient temperature ≤ 55 °C	A	12
Rated operational frequency		Hz	50/60
Frequency limits of the operational current		Hz	Up to 400
Rated operational voltage (U _e)		V	690
Rated making capacity	I _{rms} conforming to IEC 60947-1	A	66
Rated breaking capacity (for U _e ≤ 400 V)	Conforming to IEC 60947-1	A	52
Short time rating	In free air for a time "t" from cold state (θ ≤ 55 °C)	A	50
Short-circuit protection	gl fuse U ≤ 440 V	A	16
Average impedance per pole	At I _{th} and 50 Hz	mΩ	4
Maximum rated operational current			
For a temperature ≤ 55 °C	AC-3 ⁽¹⁾ (U _e ≤ 400 V)	A	6
	AC-1	A	12
Utilisation in category AC-1 resistive circuits, heating, lighting (U _e ≤ 440 V)	Increase in operational current by paralleling of poles	A	20

Auxiliary contact characteristics of add-on blocks			
Rated operational voltage (U _e)	Up to	V	690
Rated insulation voltage (U _i)	Conforming to IEC 60947, IEC 60947-1	V	690
Conventional thermal current (I _{th})	For ambient temperature ≤ 55 °C	A	10
Frequency of operational current		Hz	Up to 400
Short-circuit protection	Conforming to IEC 60947 and IEC 60947-1, gl fuse	A	10

Operational power of contacts conforming to IEC 60947

a.c. supply, category AC-15

Electrical durability (valid up to 3600 operating cycles per hour) on an inductive load such as the coil of an electromagnet: making current (cos φ 0.7) = 10 times the breaking current (cos φ 0.4).

	V	24	48	110/127	220/230	380/400	440
1 million operating cycles	VA	48	96	240	440	800	880
3 million operating cycles	VA	17	34	86	158	288	317
10 million operating cycles	VA	7	14	36	66	120	132
Occasional making capacity	VA	1000	2050	5000	10000	14000	13000

d.c. supply, category DC-13

Electrical durability (valid up to 1200 operating cycles per hour) on an inductive load such as the coil of an electromagnet, without economy resistor, the time constant increasing with the load.

	V	24	48	110	220	440	440
1 million operating cycles	W	120	80	60	52	51	880
3 million operating cycles	W	55	38	30	28	26	317
10 million operating cycles	W	15	11	9	8	7	132
Occasional making capacity	W	720	600	400	300	230	13000

⁽¹⁾ For LC1 contactors.

TeSys contactors

Mini-contactors TeSys LC1 SK and LP1 SK

Control circuit characteristics				
Type			LC1 SK06	LP1 SK06
Rated control circuit voltage (Uc)		V	~ 24...400	~ 12...72
Control voltage limits (q ≤ 50 °C)	For operation		0.85...1.1 Uc	0.85...1.1 Uc
	For drop-out		≥ 0.20 Uc	≥ 0.10 Uc
Average coil consumption at 20 °C and at Uc	Inrush		16 VA	2.2 W
	Sealed		4.2 VA	2.2 W
Heat dissipation		W	1.4	2.2
Operating time at 20 °C and at Uc	Between coil energisation and	opening of the N/C contacts	ms	8...16
		closing of the N/O contacts	ms	7...14
	Between coil de-energisation and	opening of the N/O contacts	ms	6...8
		closing of the N/C contacts	ms	8...10
Maximum operating rate	In operating cycles per hour		1200	1200
Mechanical durability at Uc In millions of operating cycles	50/60 Hz coil		10	–
	~ coil		–	10

TeSys contactors

Mini-contactors TeSys LC1 SK and LP1 SK

Use in category AC-3 ($U_e \leq 440\text{ V}$)

Control of 3-phase asynchronous squirrel cage motors with breaking whilst running.

The current broken (I_c) in category AC-3 is equal to the rated operational current (I_e) of the motor.

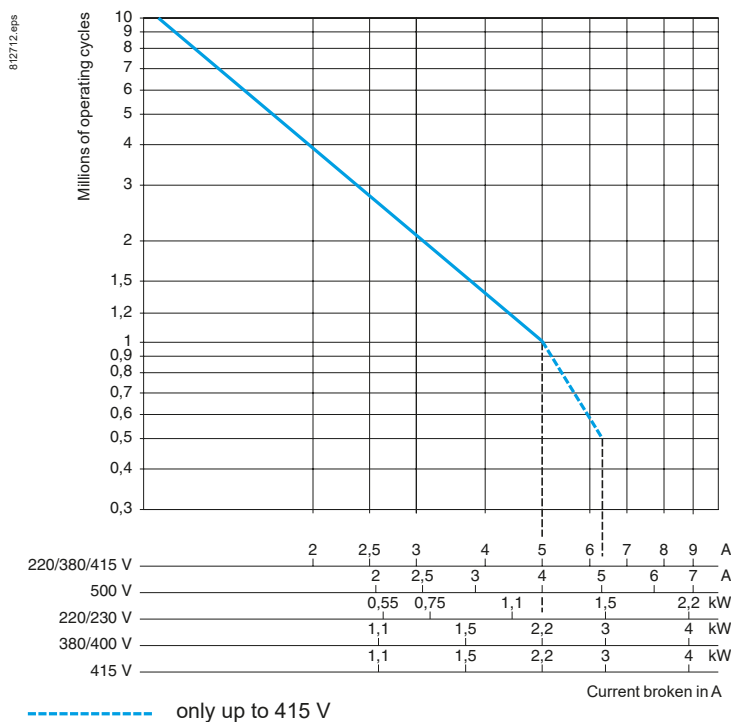

Use in category AC-1 ($U_e \leq 440\text{ V}$)

Control of resistive circuits ($\cos \varphi \geq 0.95$).

The current broken (I_c) in category AC-1 is equal to the current (I_e) normally drawn by the load.

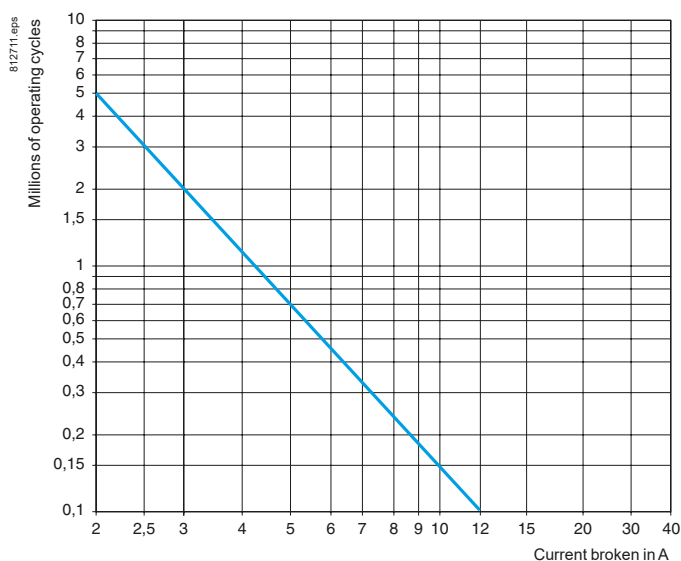

Contactors

TeSys contactors

Mini-contactors TeSys LC1 SK and LP1 SK

Dimensions

Mini-contactors

LC1 and LP1 SK06

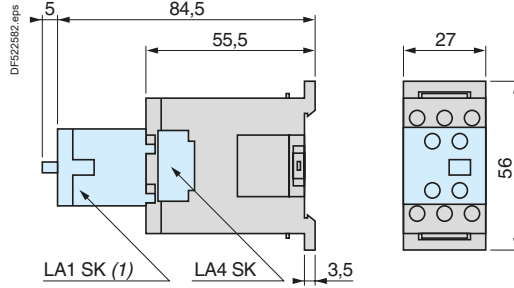

(1) Only on LC1 SK06.

Mounting

Mini-contactors

LC1 and LP1 SK06

On mounting rail AM1 DP200 or AM1 DE200 (≈ 35 mm)

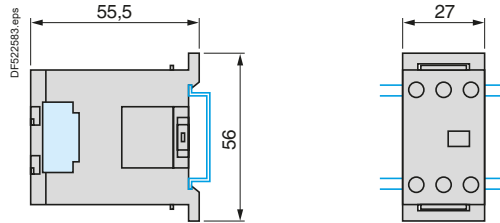

Schemes

2-pole mini-contactors

LC1 and LP1 SK06

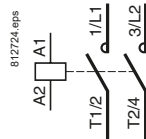

Add-on power pole block

1 pole + 1 "N/O" aux.

LA1 SK10



1 pole + 1 "N/C" aux.

LA1 SK01



Instantaneous auxiliary contacts

2 "N/O"

LA1 SK20

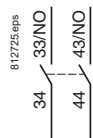

2 "N/C"

LA1 SK02

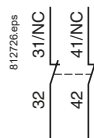

1 "N/O" + 1 "N/C"

LA1 SK11



TeSys contactors

TeSys K contactors and reversing contactors

Environment characteristics									
Conforming to standards		IEC/EN 60947-4-1, IEC/EN 60947-5-1, UL 60947-4-1, CSA C22.2 n° 60947-4-1, UL 60947-5-1, CSA C22.2 n° 60947-5-1, GB/T 14048.4							
Product certifications	LC● and LP● K06 to K12	UL, CSA, CCC, EAC, CB certification							
Operating positions									
Connection	Screw clamp terminals	Solid conductor	mm²	Min.	1 x 1.5	Max.	2 x 4	Max. to IEC 60947	1 x 4 + 1 x 2.5
		Flexible conductor without cable end	mm²	1 x 0.75	2 x 4	2 x 2.5			
		Flexible conductor with cable end	mm²	1 x 0.34	1 x 1.5 + 1 x 2.5	1 x 1.5 + 1 x 2.5			
	Spring terminals	Solid conductor	mm²	1 x 0.75	1 x 1.5	2 x 1.5			
		Flexible conductor without cable end	mm²	1 x 0.75	1 x 1.5	2 x 1.5			
	Faston connectors	Clip	mm	2 x 2.8 or 1 x 6.35					
	Solder pins for printed circuit board			With locating device between power and control circuits pins length 5 mm Recommended minimum width and thickness layer for power printed circuit board track : 4mm x 35 microns					
Tightening torque	of screw-clamp terminals only Philips head n° 2 and Ø6	N.m	0.8						
Terminal referencing	Conforming to standards EN 50005 and EN 50012		Up to 5 contacts, depending on model						
Rated insulation voltage (Ui)	Conforming to IEC 60947-4-1	V	690						
	Conforming to CSA 22-2 n° 60947-4-1, UL 60947-4-1	V	600						
Rated impulse withstand voltage (Uimp)		kV	8						
Degree of protection	Conforming to IEC 60529		Protection against direct finger contact IP2x						
Ambient air temperature around the device	Storage	°C	-50...+80						
	Operation	°C	-25...+50 in AC3, -25...+60 in AC1						
Maximum operating altitude	Without derating	m	2000						
Vibration resistance 5 ... 300 Hz	Contacteur open		2 gn						
	Contacteur closed		4 gn						
Flame resistance	according to IEC 60695-2-10	°C	850						
Shock resistance (1/2 sine wave, 11 ms)	Contacteur open		On X axis: 6 gn On Y and Z axes: 10 gn						
	Contacteur closed		On X axis: 10 gn On Y and Z axes: 15 gn						

TeSys contactors

TeSys K contactors and reversing contactors

Pole characteristics								
Type	LC● or LP●			K06	K09	K12	K16	
Conventional thermal current (Ith)	For ambient temperature ≤ 60 °C		A	20 ⁽¹⁾				
Rated operational frequency			Hz	50/60				
Frequency limits of the operational current			Hz	Up to 400				
Rated operational voltage (Ue)			V	690				
Rated making capacity	I rms conforming to IEC 60947		A	110	110	144	160	
Rated breaking capacity	I rms conforming to IEC 60947	220/230 V	A	110	110	–	–	
		380/400 V	A	110	110	–	–	
		415 V	A	110	110	–	–	
		440 V	A	110	110	110	110	
		500 V	A	80	80	80	80	
		660/690 V	A	70	70	70	70	
Permissible short time rating	In free air for a time "t" from cold state (θ ≤ 50 °C)	1 s	A	90	90	115	115	
		5 s	A	85	85	105	105	
		10 s	A	80	80	100	100	
		30 s	A	60	60	75	75	
		1 min	A	45	45	55	55	
		3 min	A	40	40	50	50	
		≥ 15 min	A	20	20	25	25	
Short-circuit protection	gG fuse U ≤ 440 V (aM fuse, see page 22009/2)		A	25				
Average impedance per pole	At Ith and 50 Hz		mΩ	3				
Use in category AC-1 resistive circuits, heating, lighting (Ue ≤ 440 V)	Maximum rated operational current for a temperature ≤ 50 °C		A	20				
	Maximum rated operational current for a temperature ≤ 70 °C		A	16 for Ue only				
	Rated operational current limits in relation to the on-load factor and operating frequency			On-load factor		90 %	60 %	30 %
			A	300 operating cycles/hour		13	15	18
			A	120 operating cycles/hour		15	18	19
			A	30 operating cycles/hour		19	20	20
	Increase in rated operational current by paralleling of poles			Apply the following coefficients to the above currents; these coefficients take into account an often unbalanced distribution of current between the poles				
			2 poles in parallel: K = 1.60					
			3 poles in parallel: K = 2.25					
			4 poles in parallel: K = 2.80					
Use in category AC-3 squirrel cage motors	Operational power according to the voltage. Voltage 50 or 60 Hz	115 V single-ph.	kW	0.37	0.55	–	–	
		220 V single-ph.	kW	0.75	1.1	–	–	
		220/230 V 3-ph.	kW	1.5	2.2	3	4	
		380/415 V 3-ph.	kW	2.2	4	5.5	7.5	
		440/480 V 3-ph.	kW	3	4	5.5/4 (480)	5.5/4 (480)	
		500/600 V 3-ph.	kW	3	4	4	4	
		660/690 V 3-ph.	kW	3	4	4	4	
		Maximum operating rate (in operating cycles/hour in relation to % of rated power)			Op. cycles/h		600	900
				Power		100 %	75 %	50 %

(1) For LC●K●●●●●3 / LP●K●●●●●3 with spring terminal, Ith max = 10 A.

TeSys contactors

TeSys K contactors and reversing contactors

Control circuit characteristics									
Type		LC1	LC2	LC7	LC8	LP1	LP2	LP4	LP5
Rated control circuit voltage (Uc)	V	~ 12...690 ⁽¹⁾		~ 24...240 ⁽¹⁾		~ 12...250 ⁽¹⁾		~ 12...120	
Control voltage limits (≤ 50 °C) single voltage coil	Operation	0.8...1.15 Uc ⁽²⁾		0.85...1.1 Uc		0.8...1.15 Uc		0.7...1.30 Uc	
	Drop-out	≥ 0.20 Uc		≥ 0.10 Uc		≥ 0.10 Uc		≥ 0.10 Uc	
Average consumption at 20 °C and at Uc	Inrush	30 VA		3 VA		3 W		1.8 W	
	Sealed	4.5 VA		3 VA		3 W		1.8 W	
Heat dissipation	W	1.3		3		3		1.8	
Operating time at 20 °C and at Uc									
Between coil energisation and:	- opening of the N/C contacts	ms	5...15		25...35		25...35		25...35
	- closing of the N/O contacts	ms	10...20		30...40		30...40		30...40
Between coil de-energisation and:	- opening of the N/O contacts	ms	10...20		30		10		10...20
	- closing of the N/C contacts	ms	15...25		40		15		15...25
Maximum immunity to microbreaks		ms	2		2		2		2
Maximum operating rate	In operating cycles per hour		3600		3600		3600		3600
Mechanical durability at Uc In millions of operating cycles	50/60 Hz coil		10	5	10	5	-	-	-
	--- coil		-	-	-	-	10	5	-
	Wide range coil, Low consumption		-	-	-	-	-	-	30 5

(1) For mains supplies with a high level of interference (voltage surge > 800 V), use a suppressor module **LA4 KE1FC** (50...129 V) or **LA4 KE1UG** (130...250 V), see page B8/50.

(2) **LC1K12, LC1K16...** : 0.85...1.15 Uc.

TeSys contactors

TeSys K contactors and reversing contactors

Auxiliary contact characteristics of contactors and instantaneous contact blocks

Number of auxiliary contacts	On LC● K or LP● K 3-pole On LA1 K		1 2 or 4
Rated operational voltage (Ue)	Up to	V	690
Rated insulation voltage (Ui)	Conforming to IEC 60947	V	690
	Conforming to UL 60947-5-1, CSA C22.2 n° 60947-5-1	V	600
Conventional thermal current (Ith)	For ambient temperature ≤ 50 °C	A	10
Frequency of the operational current		Hz	Up to 400
Minimum switching capacity	U min	V	17
	I min	mA	5
Short-circuit protection	Conforming to IEC 60947, gG fuse	A	10
Rated making capacity	Conforming to IEC 60947	I rms	A 110
Short-time rating	Permissible for	1 s	A 80
		500 ms	A 90
		100 ms	A 110
Insulation resistance		MΩ	> 10
Non-overlap distance	LA1 K: linked contacts conforming to INRS, BIA and CNA specifications	mm	0.5 (see schemes pages B8/98 and B8/100)

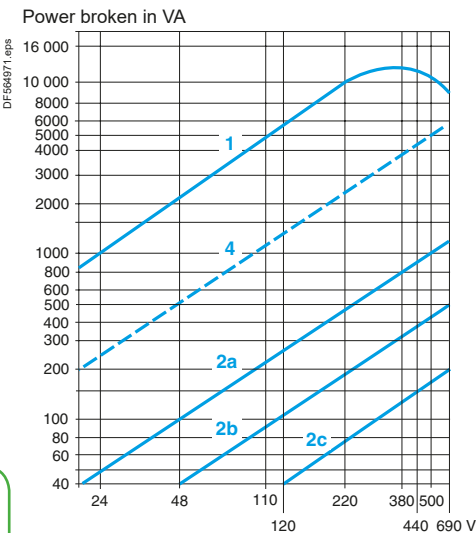

Operational power of contacts conforming to IEC 60947 a.c. supply, category AC-15

Electrical durability (valid for up to 3600 operating cycles/hour) on an inductive load such as the coil of an electromagnet: making current (cos φ 0.7) = 10 times the power broken (cos φ 0.4).

Operating cycles	V	24	48	110/127	220/230	380/400	440	600/690
1 million operating cycles	VA	48	96	240	440	800	880	1200
3 million operating cycles	VA	17	34	86	158	288	317	500
10 million operating cycles	VA	7	14	36	66	120	132	200
Occasional making capacity	VA	1000	2050	5000	10000	14000	13000	9000

d.c. supply, category DC-13

Electrical durability (valid for up to 1200 operating cycles/hour) on an inductive load such as the coil of an electromagnet, without economy resistor, the time constant increasing with the load.

Operating cycles	V	24	48	110	220	440	600
1 million operating cycles	W	120	80	60	52	51	50
3 million operating cycles	W	55	38	30	28	26	25
10 million operating cycles	W	15	11	9	8	7	6
Occasional making capacity	W	720	600	400	300	230	200

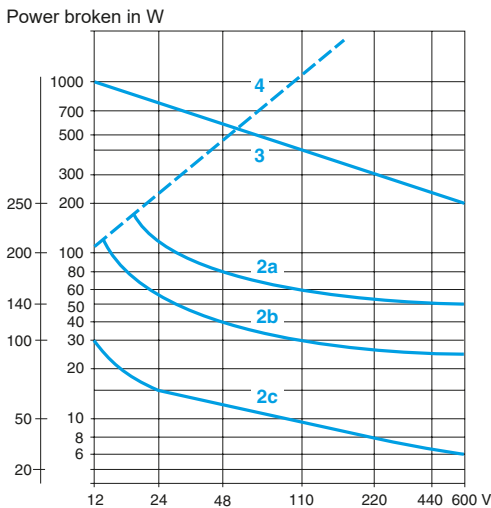

- Breaking limit of contacts valid for:
 - maximum of 50 operating cycles at 10 s intervals (power broken = making current x cos φ 0.7).
- Electrical durability of contacts for:
 - 1 million operating cycles (2a)
 - 3 million operating cycles (2b)
 - 10 million operating cycles (2c).
- Breaking limit of contacts valid for:
 - maximum of 20 operating cycles at 10 s intervals with current passing for 0.5 s per operating cycle.
- Thermal limit.

Dimensions, mounting - TeSys K

TeSys contactors

TeSys K contactors

Contactors

LC1 K, LC7 K, LP1 K, LP4 K

On panel

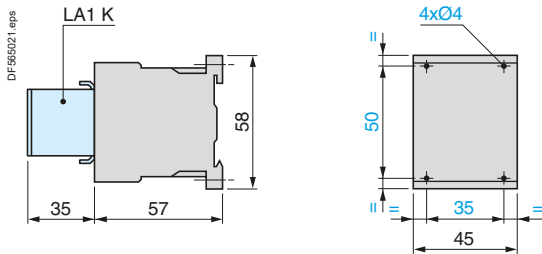

On mounting rail AM1 DP200 or AM1 DE200 (L 35 mm)

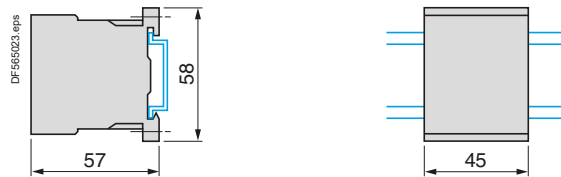

LA9 D973

On one asymmetrical rail DZ5 MB with clip-on mounting plates

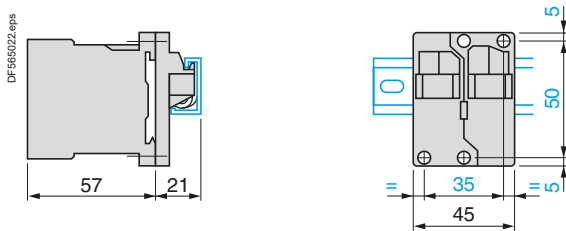

DX1 AP25

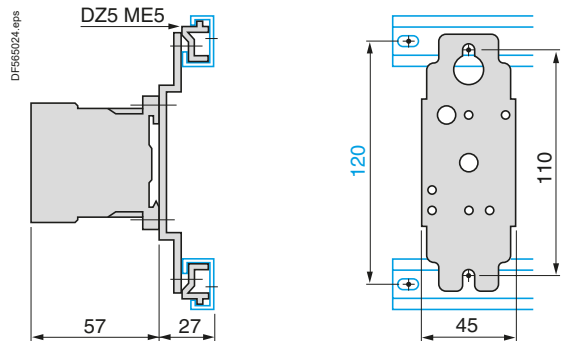

On printed circuit board

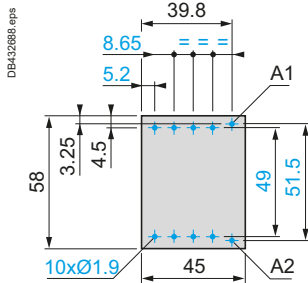

Electronic time delay contact blocks

LA2 KT



On contactor

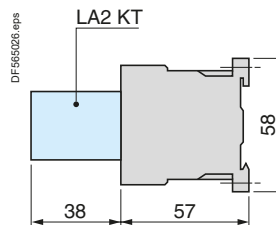

Suppressor modules

LA4 K●



On contactor LC1 K or LP1 K

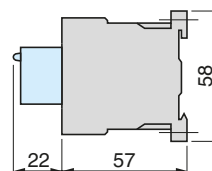

3-pole contactors

3 P + N/O

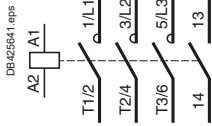

3 P + N/C

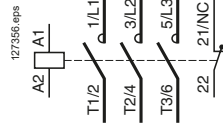

With integral suppression device

LC7 K

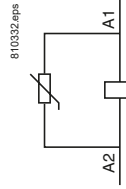

LP4 K

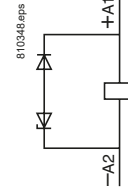

4-pole contactors

4 P

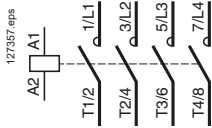

2 P N/O + 2 P N/C

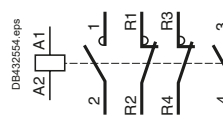

With integral suppression device

LC7 K

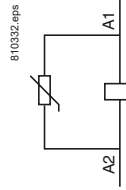

LP4 K

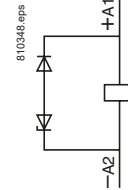

Instantaneous auxiliary contacts LA1 K

LA1 KN20, KN207, KN203

2 N/O

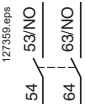

LA1 KN02, KN027, KN023

2 N/C

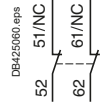

LA1 KN11, KN117, KN113

1 N/O + 1 N/C



LA1 KN40, KN407, KN403

4 N/O



LA1 KN31, KN317, KN313

3 N/O + 1 N/C

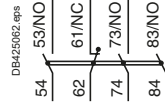

LA1 KN22, KN227, KN223

2 N/O + 2 N/C

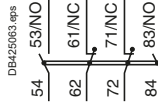

LA1 KN13, KN137, KN133

1 N/O + 3 N/C

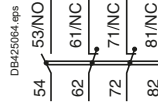

LA1 KN04, KN047, KN043

4 N/C

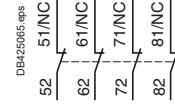

Terminal referencing conforming to standard EN 50012

LA1 KN02M

2 N/C

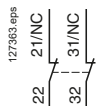

LA1 KN11M

1 N/O + 1 N/C

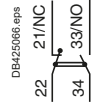

LA1 KN31M

3 N/O + 1 N/C

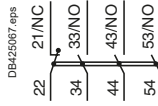

LA1 KN22M

2 N/O + 2 N/C

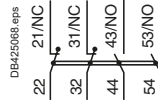

LA1 KN13M

1 N/O + 3 N/C

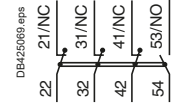

LA1 KN11P

1 N/O + 1 N/C

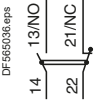

LA1 KN22P

2 N/O + 2 N/C

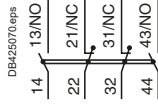

Electronic time delay contact blocks

LA2 KT

1 C/O

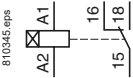

Suppressor modules

LA4 KC

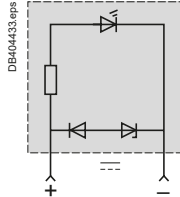

LA4 KE

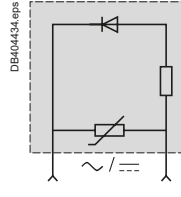

TeSys contactors

TeSys K reversing contactors

Reversing contactors

LC2 K, LC8 K, LP2 K, LP5 K

On panel

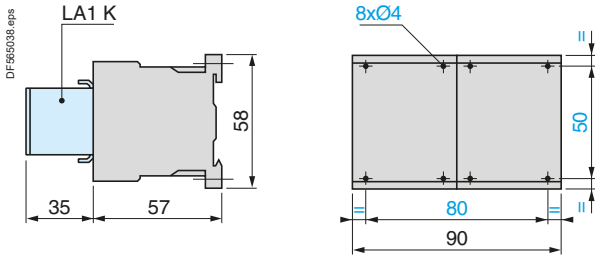

On mounting rail AM1 DP200 or AM1 DE200 (└ 35 mm)

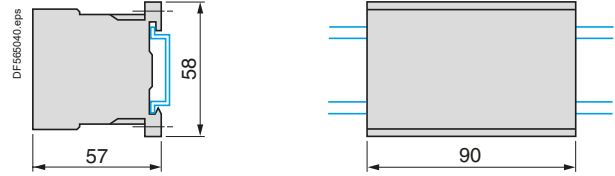

2 x LA9 D973

2 x DX1 AP25

On one asymmetrical mounting rail DZ5 MB with 2 clip-on mounting plates LA9 D973 or on 2 mounting plates DX1 AP25.

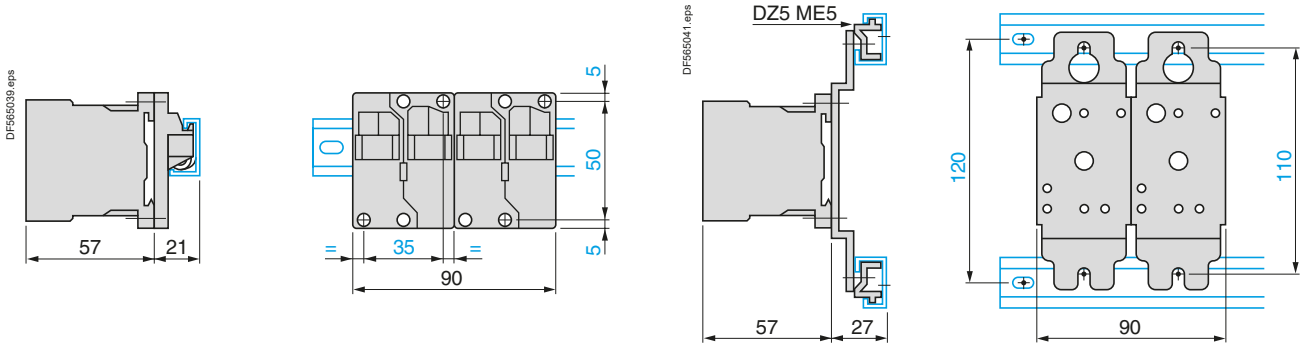

On printed circuit board for reversing contactors or 2 contactors mounted side by side.

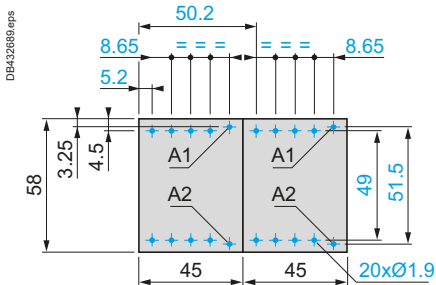

Electronic time delay contact blocks

LA2 KT

On reversing contactors

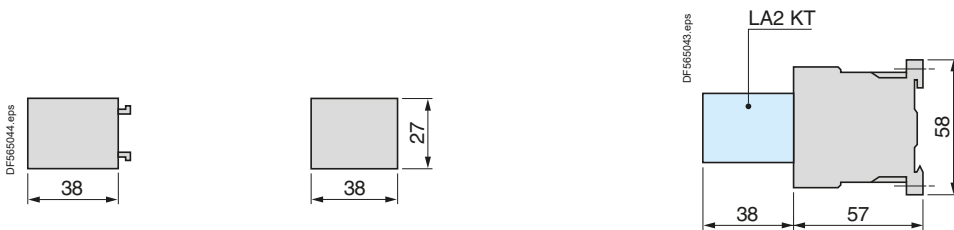

Suppressor modules

LA4 K

On reversing contactors LC2 K or LP2 K



3-pole reversing contactors

With screw clamp connections

3 P + N/O

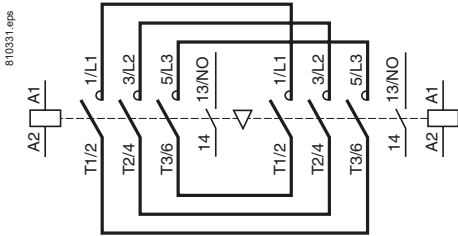

3 P + N/C

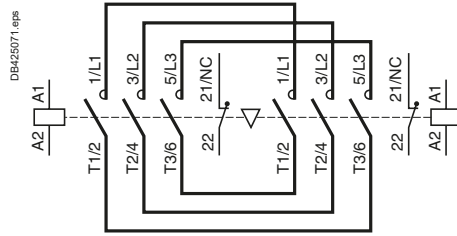

With integral suppression device

LC8 K

LP5 K

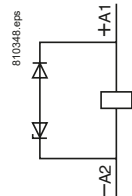
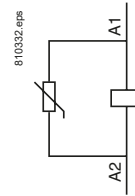

With Faston connectors or solder pins (printed circuit board)

3 P + N/O

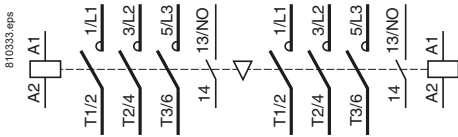

3 P + N/C

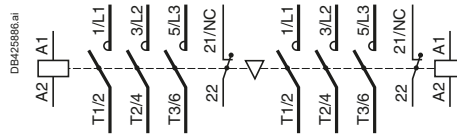

4-pole reversing contactors

With screw clamp connections

4 P

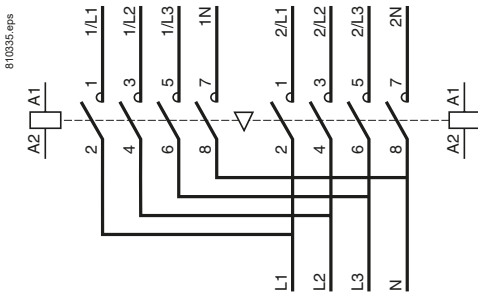

4 P

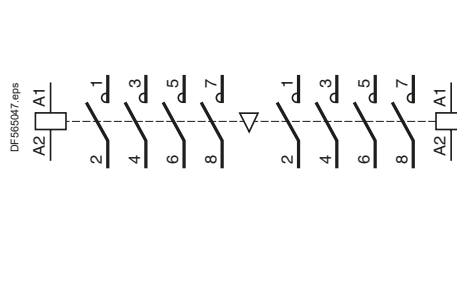

Integral suppression device

LC8 K

LP5 K

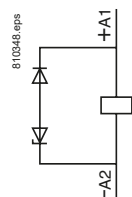
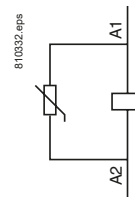

Instantaneous auxiliary contacts LA1 K

Terminal referencing conforming to standard EN 50012

LA1 KN20, KN207, KN203

LA1 KN02, KN027, KN023

LA1 KN11, KN117, KN113

LA1 KN02M

LA1 KN11M

LA1 KN11P

2 N/O

2 N/C

1 N/O + 1 N/C

2 N/C

1 N/O + 1 N/C

1 N/O + 1 N/C

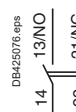
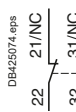
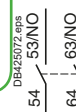

LA1 KN40, KN407, KN403

LA1 KN31, KN317, KN313

LA1 KN22, KN227, KN223

LA1 KN13, KN137, KN133

LA1 KN04, KN047, KN043

4 N/O

3 N/O + 1 N/C

2 N/O + 2 N/C

1 N/O + 3 N/C

4 N/C

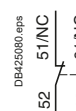
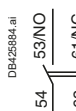
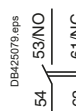
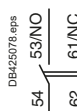

Electronic time delay contact blocks

LA2 KT

1 C/O

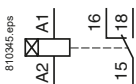

Suppressor modules

LA4 KC

LA4 KE

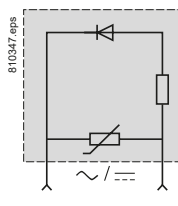
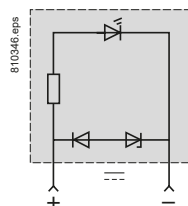

TeSys contactors

Mini-contactors TeSys LC1SKGC, for use in modular panels

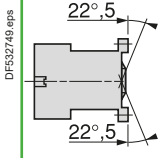
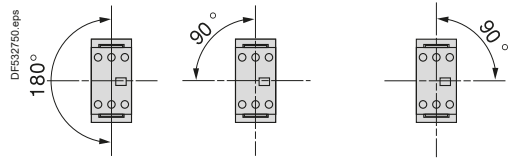
Environment			
Rated insulation voltage (Ui)	Conforming to IEC 60947	V	690
Conforming to standards			IEC 60947, UL 60947-4-1, CSA C22.2 n° 60947-4-1
Approvals			cULus
Degree of protection	Conforming to IEC 60529		Protection against direct finger contact
Ambient air temperature around the device			
	Storage	°C	-50...+70
	Operation	°C	-20...+50
Maximum operating altitude	Without derating	m	2000
Operating position			<p>Vertical axis</p>  <p>Horizontal axis</p> 
Cabling, connectors			Min.
	Solid conductor	mm²	1 x 1.5 or 2 x 1.5
	Flexible cable without cable end	mm²	1 x 0.5 or 2 x 0.35
	Flexible cable with cable end	mm²	1 x 0.35 or 2 x 0.35
			Max.
			1 x 6 or 2 x 4
			1 x 6 or 2 x 2.5
			1 x 6 or 2 x 1.5
Tightening torque	Pozidriv n° 1 head	N.m	0.8
Terminal referencing			Conforming to standards EN 50005

TeSys contactors

Mini-contactors TeSys LC1SKGC, for use in modular panels

Pole characteristics					
Mini-contactor type		LC1 SKGC2	LC1 SKGC3 and LC1 SKGC4		
Conventional thermal current (I _{th})	For ambient temperature ≤ 55 °C	A	20	20	
Rated operational frequency		Hz	50/60		
Frequency limit of the operational current		Hz	up to 400		
Rated operational voltage (U _e)		V	690		
Rated making capacity	I rms conforming to IEC 60947	A	50	85	
Rated breaking capacity (for U _e ≤ 400 V)	Conforming to IEC 60947 (I rms)	A	40	68	
Permissible short time rating	In free air for a time "t" from cold state (θ ≤ 55 °C)	A	40	60	
Short-circuit protection	gl fuse U ≤ 440 V	A	20	20	
Average impedance per pole	At I _{th} and 50 Hz	mΩ	4	4	
Maximum rated operational current	For temperature ≤ 55 °C	AC-3 (U _e ≤ 400 V)	A	5	9
		AC-1	A	20	20
Use in category AC-1 resistive circuits, heating, lighting (U _e ≤ 440 V)	Increase in rated operational current by paralleling of 2 poles	A	32	32	

Auxiliary contact characteristics of mini-contactors			
Rated operational voltage (U _e)	Up to	V	690
Rated insulation voltage (U _i)	Conforming to IEC 60947	V	690
Conventional thermal current (I _{th})	For ambient temperature ≤ 55 °C	A	10
Frequency of the operational current		Hz	Up to 400
Short-circuit protection	Conforming to IEC 60947, gl fuse	A	10

Operational power of contacts conforming to IEC 60947

a.c. supply, category AC-15

Electrical durability (valid for up to 3600 operating cycles/hour) on an inductive load such as the coil of an electromagnet: making current (cos φ 0.7) = 10 times the power broken (cos φ 0.4).

	V	24	48	110/ 127	220/ 230	380/ 400	440
1 million operating cycles	VA	48	96	240	440	800	880
3 million operating cycles	VA	17	34	86	158	288	317
10 million operating cycles	VA	7	14	36	66	120	132
Occasional making capacity	VA	1000	2050	5000	10000	14000	13000

d.c. supply, category DC-13

Electrical durability (valid for up to 1200 operating cycles/hour) on an inductive load such as the coil of an electromagnet, without economy resistor, the time constant increasing with the load.

	V	24	48	110	220	440	440
1 million operating cycles	W	120	80	60	52	51	880
3 million operating cycles	W	55	38	30	28	26	317
10 million operating cycles	W	15	11	9	8	7	132
Occasional making capacity	W	720	600	400	300	230	13000

TeSys contactors

Mini-contactors TeSys LC1SKGC, for use in modular panels

Control circuit characteristics			
Mini-contactor type		LC1 SKGC2	LC1 SKGC3 and LC1 SKGC4
Rated control circuit voltage (Uc)	V	~ 24...400	
Control voltage limits ($\theta \leq 55\text{ }^{\circ}\text{C}$)	Operation	0.85...1.1 Uc	
	For drop-out	$\geq 0.20\text{ }U_c$	
Average coil consumption at 20 °C and at Uc	Inrush	VA 16	23
	Sealed	VA 4.2	4.9
Heat dissipation	W	1.4	1.5
Operating time at 20 °C and at Uc	Between coil energisation and	opening of the N/C contacts	ms 8...16
		closing of the N/O contacts	ms 7...14
	Between coil de-energisation and	opening of the N/O contacts	ms 6...8
		closing of the N/C contacts	ms 8...10
Maximum operating rate	In operating cycles per hour	1200	
Mechanical durability at Uc	50/60 Hz coil in millions of operating cycles	10	

TeSys contactors

Mini-contactors TeSys LC1SKGC, for use in modular panels

Use in category AC-3 ($U_e \leq 440\text{ V}$)

Control of 3-phase asynchronous squirrel cage motors with breaking whilst running. The current broken (I_c) in category AC-3 is equal to the rated operational current of the motor.

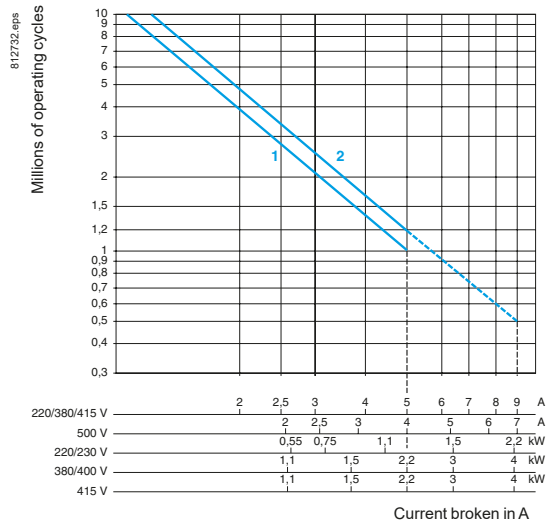

1. LC1 SKGC2
 2. LC1 SKGC3 and SKGC4
- only up to 415 V

Use in category AC-1 ($U_e \leq 440\text{ V}$)

Control of resistive circuits ($\cos \varphi \geq 0.95$).

The current broken (I_c) in category AC-1 is equal to the current (I_e) normally drawn by the load.

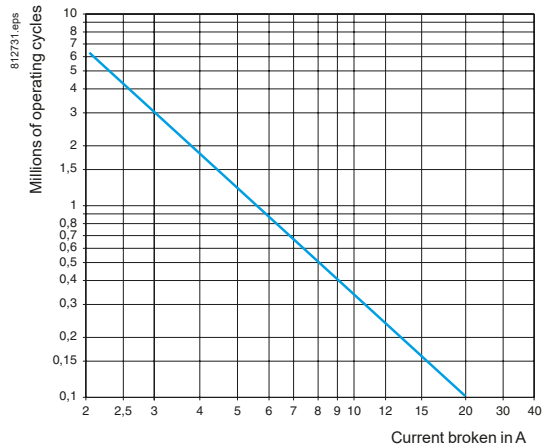

Dimensions, mounting, schemes - TeSys SKGC

TeSys contactors

Mini-contactors TeSys LC1SKGC, for use in modular panels

Dimensions	Mounting
Mini-contactors LC1 SKGC2	On mounting rail AM1 DP200 or AM1 DE200 (└ 35 mm)

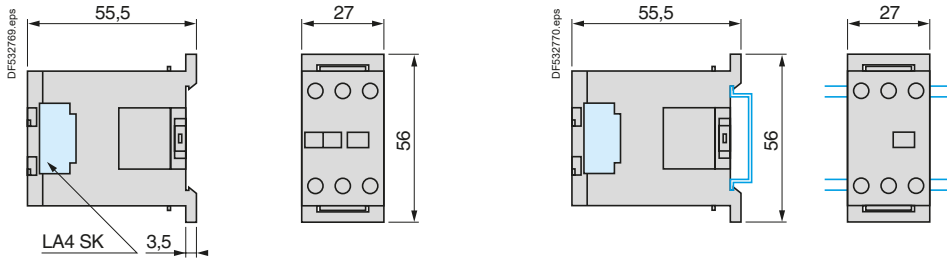

Dimensions	Mounting
Mini-contactors LC1 SKGC3 and SKGC4	On panel On mounting rail AM1 DP200 or AM1 DE200 (└ 35 mm)

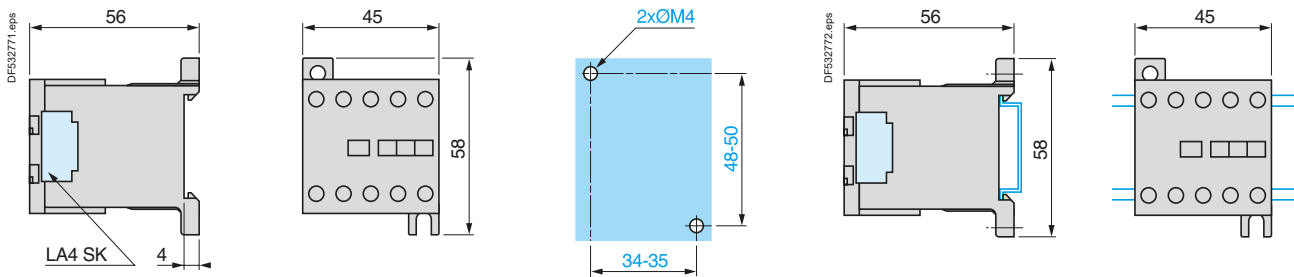

2-pole mini-contactors

LC1 SKGC2

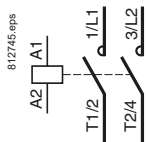

3-pole mini-contactors

LC1 SKGC310 LC1 SKGC301

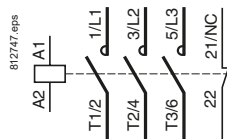
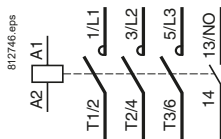

4-pole mini-contactors

LC1 SKGC400

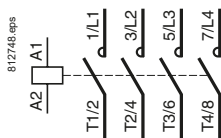

Modular equipment

Standard contactors TeSys GC



GC 25

Presentation

TeSys GC contactors are designed for use in modular panels and enclosures. These contactors feature:

■ Easy installation:

- quick clip-on fixing and locking onto 35 mm omega rail
- easy connection by means of ready-to-tighten, captive, pozidrive screw terminals.

■ Compact size:

All units have a common depth of 60 mm and width in modules of 17.5 mm (width of one module: 17.5 mm).

■ User safety:

- use of materials conforming to strictest fire safety standards
- live parts protected against direct finger contact
- completely safe operation
- state indication on front panel.

Standards

This range of modular contactors has been designed taking into account the requirements of international standard IEC 61095.

This standard is specific to "Electromagnetic contactors for domestic and similar use".

It has very strict requirements, meeting the expectations of users, with regard to the safety of equipment and persons in "premises and areas accessible to the public". Conformity with this standard makes it possible to obtain the following quality labels without the need for additional tests: NF-USE, VDE, CEBEC, etc.

Applications

TeSys GC modular contactors are designed for switching all single-phase, 3-phase or 4-phase loads up to 100 A.

Power switching

These contactors have multiple applications in industrial, agricultural and commercial premises, hospitals and the home, i.e. wherever switching of a specific supply is required:

- lighting
- heating
- ventilation
- motorised shutters or gates.

Setting-up precautions

The contactor controls must be bounce free. If not, connect a coil suppression block **1** (GAP 21 or 23) across the coil terminals y 250 V.

When several contactors which operate at the same time are mounted side by side, a GAC 5 ventilation 1/2 module **2** must be fitted every 2 contactors.

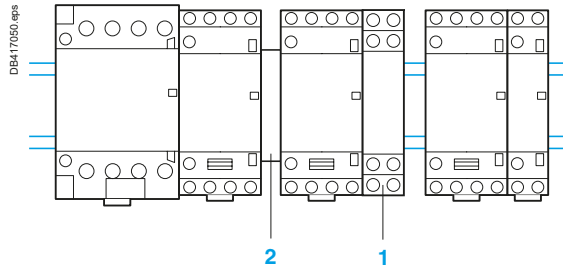

It is advisable to mount electronic units at the bottom of the modular panel and to separate them from electromechanical units by a space **3** equal to one module, or by 2 ventilation 1/2 modules (GAC 5).

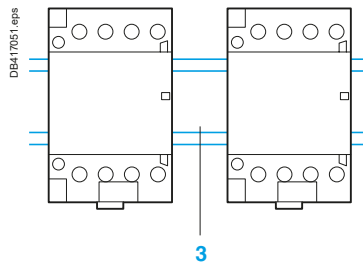

Derating of contactors mounted in a modular enclosure if the temperature within the enclosure is $> 40\text{ }^{\circ}\text{C}$.

Contactor rating	40 °C	50 °C	60 °C ⁽¹⁾
16 A	16 A	14 A	13 A
25 A	25 A	22 A	20 A
40 A	40 A	36 A	32 A
63 A	63 A	57 A	50 A
100 A	100 A	87 A	80 A

⁽¹⁾ Ventilation 1/2 module must be fitted.

Lighting (Maximum number of lamps depending on the power of each unit) Presentation of installations according to type of supply

■ Single-phase circuit, 230 V

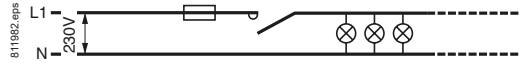

■ 3-phase circuit, 230 V

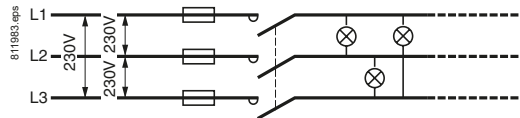

The maximum number of lamps which can be operated per phase is equal to the number of lamps in the "single phase 230 V" table divided by $\sqrt{3}$.

■ 3-phase circuit, 400 V (with neutral)

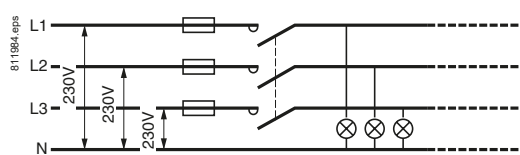

The maximum number of lamps which can be operated per phase is equal to the total number of lamps in the "single-phase 230 V" table.

Contactor rating for a single-phase 230 V circuit (single-pole)

Fluorescent lamps with starter

Single fitting	Non corrected					With parallel correction					Contactor rating
	P (W)	I_B (A)	C (μ F)	Maximum number of lamps		P (W)	I_B (A)	C (μ F)	Maximum number of lamps		
Twin fitting	20	0.39	-	22	30	20	0.19	5	15	20	16 A
	40	0.43	-	20	28	40	0.29	5	15	15	25 A
	50	0.70	-	13	17	40	0.46	7	10	15	40 A
	80	0.80	-	10	15	40	0.57	7	10	10	63 A
Twin fitting	110	1.2	-	7	10	110	0.79	16	5	7	63 A
	20	0.44	-	22	30	20	0.26	3.5	15	20	16 A
	40	0.82	-	20	16	40	0.48	4.5	17	10	25 A
	50	1.34	-	13	10	50	0.78	7	10	9	40 A
Twin fitting	80	1.64	-	10	8	80	0.96	9	10	6	63 A
	140	2.2	-	7	6	140	1.3	18	5	4	63 A
	20	0.44	-	22	30	20	0.26	3.5	15	20	16 A
	40	0.82	-	20	16	40	0.48	4.5	17	10	25 A
Twin fitting	50	1.34	-	13	10	50	0.78	7	10	9	40 A
	80	1.64	-	10	8	80	0.96	9	10	6	63 A
	140	2.2	-	7	6	140	1.3	18	5	4	63 A
	20	0.44	-	22	30	20	0.26	3.5	15	20	16 A
Twin fitting	40	0.82	-	20	16	40	0.48	4.5	17	10	25 A
	50	1.34	-	13	10	50	0.78	7	10	9	40 A
	80	1.64	-	10	8	80	0.96	9	10	6	63 A
	140	2.2	-	7	6	140	1.3	18	5	4	63 A

High pressure mercury vapour lamps

	Non corrected						With parallel correction						Contactor rating
	P (W)	I_B (A)	C (μ F)	Maximum number of lamps			P (W)	I_B (A)	C (μ F)	Maximum number of lamps			
	50	0.6	-	15	20	50	0.35	7	10	15	20	16 A	
	80	0.8	-	10	15	80	0.50	8	10	10	15	25 A	
	125	1.15	-	8	10	125	0.7	10	18	10	6	40 A	
	250	2.15	-	4	6	250	1.5	18	25	4	2	63 A	
	400	3.25	-	2	4	400	2.4	40	40	2	1	63 A	
	700	5.4	-	1	2	700	4	60	60	1	1	63 A	
	50	0.6	-	15	20	50	0.35	7	10	15	20	16 A	
	80	0.8	-	10	15	80	0.50	8	10	10	15	25 A	
	125	1.15	-	8	10	125	0.7	10	18	10	6	40 A	
	250	2.15	-	4	6	250	1.5	18	25	4	2	63 A	
	400	3.25	-	2	4	400	2.4	40	40	2	1	63 A	
	700	5.4	-	1	2	700	4	60	60	1	1	63 A	

I_B : value of current drawn by each lamp at its rated voltage.

C: unit capacitance for each lamp.

I_B and C correspond to values normally quoted by lamp manufacturers

Contactor rating for a single-phase 230 V circuit (single-pole) (continued)

Low pressure sodium vapour lamps

	Non corrected						With parallel correction						Contactor rating
P (W)	18	35	55	90	135	180	18	35	55	90	135	180	–
I _B (A)	0.35	1.4	1.4	2.1	3.1	3.1	0.35	0.6	0.6	0.9	0.9	0.9	–
C (µF)	–	–	–	–	–	–	5	20	20	26	45	40	–
Maximum number of lamps	18	4	5	3	2	2	14	3	3	2	1	1	16 A
	34	9	9	6	4	4	21	5	5	4	2	2	25 A
	57	14	14	9	6	6	40	10	10	8	4	5	40 A
	91	24	24	19	10	10	60	15	15	11	6	7	63 A

High pressure sodium vapour lamps

	Non corrected					With parallel correction					Contactor rating
P (W)	70	150	250	400	1000	70	150	250	400	1000	–
I _B (A)	1	1.8	3	4.4	10.3	0.6	0.7	1.5	2.5	6	–
C (µF)	–	–	–	–	–	12	20	32	45	100	–
Maximum number of lamps	8	4	2	1	–	6	6	2	2	1	16 A
	12	7	4	3	1	9	9	3	4	2	25 A
	20	13	8	5	2	18	18	6	8	4	40 A
	32	18	11	8	3	25	25	9	12	6	63 A

Metal iodine or halogen vapour lamps

	Non corrected						With parallel correction						Contactor rating	
P (W)	35	70	150	250	400	1000	39	70	150	250	400	1000	2000	–
I _B (A)	0.3	0.5	1	1.5	2.5	6	0.3	0.5	1	1.5	2.5	6	5.5	–
C (µF)	–	–	–	–	–	–	6	12	20	32	45	85	60	–

Maximum number of lamps	27	16	8	5	3	1	12	6	4	3	2	–	1	16 A
	40	24	12	8	5	2	18	9	6	4	3	1	2	25 A
	68	42	20	14	8	4	31	16	10	7	5	3	3	40 A
	106	64	32	21	13	5	50	25	15	10	7	4	5	63 A

Incandescent and halogen lamps

										Contactor rating
P (W)	60	75	100	150	200	300	500	1000		–
I _B (A)	0.26	0.32	0.44	0.65	0.87	1.3	2.17	4.4		–
Maximum number of lamps	30	25	19	12	10	7	4	2		16 A
	45	38	28	18	14	10	6	3		25 A
	85	70	50	35	26	18	10	6		40 A
	125	100	73	50	37	25	15	8		63 A

Halogen lamps used with transformer

					Contactor rating
P (W)	60	80	105	150	–
I _B (A)	0.26	0.35	0.45	0.65	–
Maximum number of lamps	9	8	6	4	16 A
	14	12	9	6	25 A
	27	23	18	13	40 A
	40	35	27	19	63 A

I_B value of current drawn by each lamp at its rated voltage.

C: unit capacitance for each lamp.

I_B and C correspond to values normally quoted by lamp manufacturers

Heating (AC-7a)

Single-phase, 2-pole switching

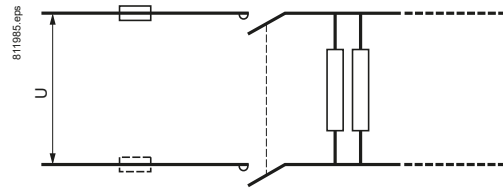

3-phase switching

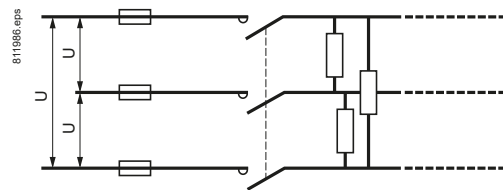

Heating by resistive elements or by infra-red radiators, convectors or radiators, heating ducts, industrial furnaces. The current peak between the hot and cold states must not exceed 2 to 3 I_n at the moment of switch-on.

Contactor selection according to power and required electrical life

Electrical durability (in operating cycles)	Maximum power (kW)					Contactor rating
	100×10^3	150×10^3	200×10^3	500×10^3	10^6	
Single-phase switching 230 V (2-pole)	3.5	3	2.2	1	0.8	16 A
	5.4	4.6	3.5	1.6	1.2	25 A
	8.6	7.4	5.6	2.6	1.9	40 A
	13.6	11.6	8.8	4	3	63 A
	21.6	18.4	14	6.4	4.8	100 A
3-phase switching 400 V (3-pole)	10	9	6.5	3.2	2.2	16 A
	16	14	10	5	3.5	25 A
	26	22	17	7.5	6	40 A
	41	35	26.5	12	9	63 A
	64.8	55.2	42	19.2	14.4	100 A

Motor control (AC-7b)

Single-phase circuit, 230 V

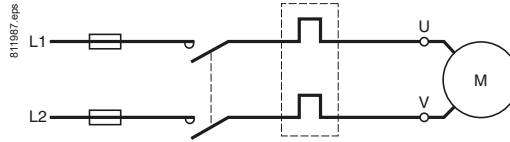

3-phase circuit, 400 V

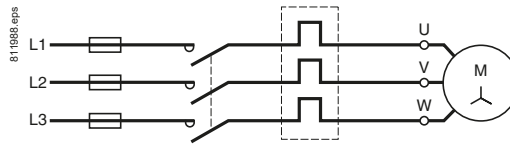

Contactor selection according to maximum power in kW

230 V single-phase capacitor motor (2-pole)	400 V 3-phase motor	Contactor rating (Ith)
0.55	2.2	16 A
1.1	4	25 A
2.2	7.5	40 A
4	11	63 A

Environment								
Contactor type			GC16	GC25	GC40	GC63	GC100	
Rated insulation voltage (Ui)	Conforming to IEC 61095	V	500					
	Conforming to VDE 0110	V	500					
Rated impulse withstand voltage (Uimp)		kV	4 in enclosure					
Conforming to standards			IEC 61095 and IEC 60947-5-1 for auxiliary contacts					
Degree of protection	Conforming to IEC 60529		Protection against direct finger contact (IP 20 open, IP 40 in enclosure)					
Ambient air temperature around the device	Storage	°C	-40...+70					
	Operation	°C	-5...+50 (0.85...1.1 Uc)					
Maximum operating altitude	Without derating	m	3000					
Operating positions	Without derating		±30° in relation to normal vertical mounting plane					
Shock resistance 1/2 sine wave = 10 ms	Contact open		10 gn					
	Contact closed		15 gn					
Vibration resistance 5...300 Hz	Contact open		2 gn					
	Contact closed		3 gn					
Flame resistance			Conforming to IEC 61095					
Pole characteristics								
Number of poles			2, 3 or 4					
Rated operational current (Ie) (Ue ≤ 440 V)	In AC-7a (heating)	A	16	25	40	63	100	
	In AC-7b (motor control)	A	5	8.5	15	25	–	
Rated operational voltage (Ue)	Up to	V	250 two-pole contactors, 415 three and four-pole contactors					
Frequency limits	Of the operating current	Hz	400					
Conventional thermal current (Ith)	θ ≤ 50 °C	A	16	25	40	63	100	
Rated breaking and making capacity	Conforming to IEC 61095 (AC-7b) I rms 400 V 3-phase	A	40	68	120	200	–	
Permissible short time rating no current flowing for preceding 15 minutes with q ≤ 40 °C	For 10 s	A	128	200	320	504	800	
	For 30 s	A	40	62	100	157	250	
Short-circuit protection by fuse or circuit breaker U ≤ 440 V	gl fuse	A	16	25	40	63	100	
	Circuit breaker I ² t (at 3 kA rms prospective)	230 V	A ² s	5000	10000	16000	18000	–
		400 V	A ² s	9000	14000	17500	20000	–
Electrical durability in operating cycles	AC-7a, AC-7b		100000	100000	100000	100000	30000	
Average impedance per pole	At Ith and 50 Hz	mΩ	2.5	2.5	2	2	1	
Power dissipated per pole	For the above operational currents	W	0.65	1.6	3.2	8	10	
Maximum cabling c.s.a.	Flexible cable without cable end	1 conductor	mm ²	6	6	25	25	35
		2 conductors	mm ²	4	4	16	16	–
	Flexible cable with cable end	1 conductor	mm ²	6	6	16	16	35
		2 conductors	mm ²	1.5	1.5	4	4	–
	Solid cable without cable end	1 conductor	mm ²	6	6	25	25	35
		2 conductors	mm ²	4	4	6	6	10
Tightening torque	Power circuit connections	N.m	0.8	0.8	3.5	3.5	3.5	

Control circuit characteristics							
Contactor type			GC16, GC25 single or 2-pole	GC16, GC25 3 or 4-pole GC40, GC63 2-pole	GC40, GC63 3 or 4-pole GC100 2-pole	GC100 4-pole	
Rated control circuit voltage (Uc)	50 or 60 Hz	V	12...240 V, for other voltages, please consult your Regional Sales Office				
Control voltage limits ($\theta \leq 50\text{ }^{\circ}\text{C}$)	50 Hz coils	Operational	0.85...1.1 Uc				
		Drop-out	0.2...0.75 Uc				
Average coil consumption at 20 °C and at Uc	~ 50 Hz	Inrush	VA	15	34	53	106
		Sealed	VA	3.8	4.6	6.5	13
Maximum heat dissipation	50/60 Hz	W	1.3	1.6	2.1	4.2	
Operating time	Closing "C"	ms	10...30				
	Opening "O"	ms	10...25				
Mechanical durability	In operating cycles		10 ⁶				
Maximum operating rate at ambient temperature $\leq 50\text{ }^{\circ}\text{C}$	In operating cycles per hour		300				
Maximum cabling c.s.a.	Flexible cable without cable end	1 or 2 conductors	mm²	2.5			
	Flexible cable with cable end	1 conductor	mm²	2.5			
		2 conductors	mm²	1.5			
	Solid cable without cable end	1 or 2 conductors	mm²	1.5			
Tightening torque		N.m	0.8				
Instantaneous auxiliary contact characteristics							
Rated operational voltage (Ue)	Up to	V	250				
Rated insulation voltage (Ui)	Conforming to IEC 60947-5	V	500				
	Conforming to VDE 0110	V	500				
Conventional thermal current (Ith)	For ambient $\theta \leq 50\text{ }^{\circ}\text{C}$	A	5				
Mechanical durability	Operating cycles		10 ⁶				
Maximum cabling c.s.a.	Flexible or solid conductor	mm²	2.5				
Tightening torque		N.m	0.8				

Dimensions

Contactors

Common side view

GC 1610, 1611, 1620
GC 2502, 2510, 2511, 2520

1 module

GC 1622, 1640
GC 2504, 2522, 2530, 2540

2 modules

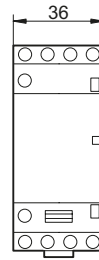
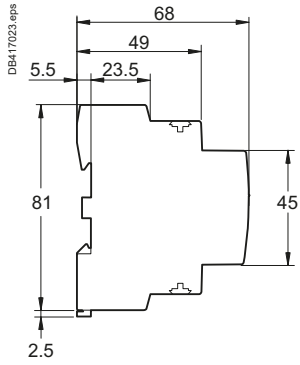

Common side view

GC 4002, 4011, 4020
GC 6302, 6311, 6320

2 modules

GC 4004, 4022, 4030, 4040
GC 6304, 6322, 6330, 6340

3 modules

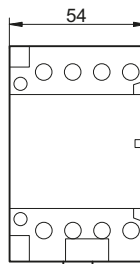
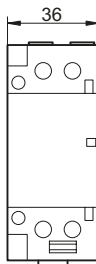
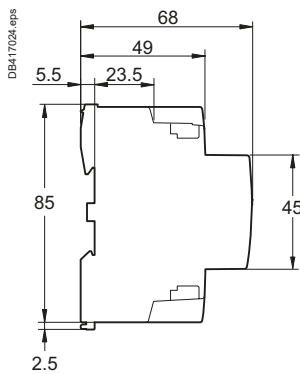

Common side view

GC 10020

3 modules

GC 10040

6 modules

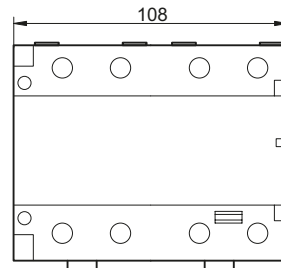
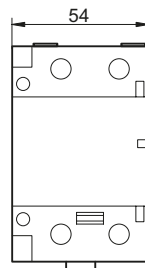
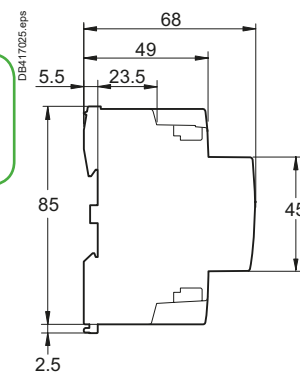

Contactors

Modular equipment

TeSys GC standard contactors

Dimensions

Auxiliary contacts

GAC 0511, 0531 and 0521

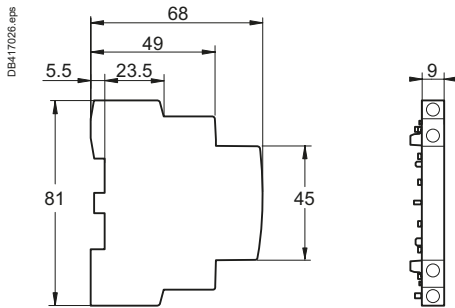

Coil suppression blocks

GAP 21 and 23

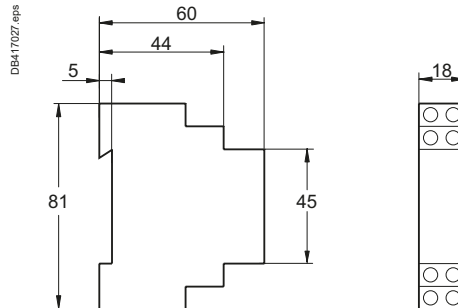

Clip-on ventilation 1/2 module

GAC 5

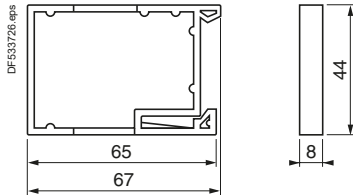

Schemes

Contactors

GC ●●10

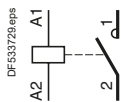

GC ●●20

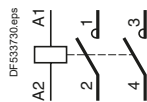

GC ●●30

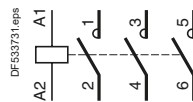

GC ●●40

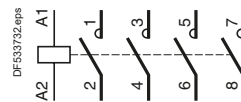

GC ●●11

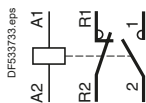

GC ●●22

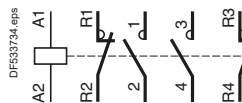

GC ●●02

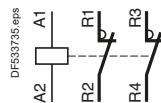

GC ●●04

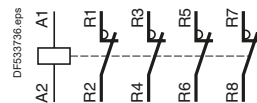

Auxiliary contacts

GAC 0521

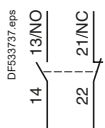

GAC 0531



GAC 0511



Modular equipment

TeSys GY "dual tariff" contactors



GY 25

Presentation

TeSys GY "dual tariff" contactors are designed for use in modular panels and enclosures.

These contactors feature:

■ **Easy installation:**

- quick clip-on fixing and locking onto 35 mm omega rail
- easy connection by means of ready-to-tighten captive, pozidrive screw terminals.

■ **Compact size**

All units have a common depth of 60 mm and width in modules of 17.5 mm (width of one module: 17.5 mm).

■ **User safety:**

- use of materials conforming to strictest fire safety standards
- live parts protected against direct finger contact
- completely safe operation
- state indication on front panel.

"Dual tariff" contactors are designed for use with Electricity Supply Authority dual tariffs.

They have a 4-position selector switch on the front panel:

"Stop" (O)	For switching off the load, e.g. for prolonged periods of absence.
"Off peak" Automatic start (A)	The contactor switches automatically during "off peak" hours as set by the Supply Authority remote control and thus supplies the load, (washing machine, dishwasher, convector heater, water heater) during this period, at an economy rate to the user.
"Peak time" Manual start (I)	In this position, the contactor supplies the load to cater for additional requirements for hot water, heating, etc., but at the standard rate. The contactor returns automatically to the "off-peak" position at the start of the "off-peak" period.
"Peak time" Manual override with lock	Facility for setting the contactor to continuous manual operation, ignoring the automation system and the Supply Authority control; setting and locking is achieved by means of a tool, with manual return to the "AUTO" position.

Standards

This range of modular contactors has been designed taking into account the requirements of international standard IEC 61095.

This standard is specific to "Electromagnetic contactors for domestic and similar use".

It has very strict requirements, meeting the expectations of users, with regard to the safety of equipment and persons in "premises and areas accessible to the public".

Conformity with this standard makes it possible to obtain the following quality labels without the need for additional tests: NF-USE, VDE, CEBEC, etc.

"Dual tariff" modular contactors are designed for switching all single-phase, 3-phase or 4-phase loads up to 63 A.

TeSys GY contactors have multiple applications in industrial, agricultural and commercial premises, hospitals and the home, i.e. wherever switching of a specific supply is required:

- lighting,
- heating, ventilation,
- motorised shutters or gates.

Modular equipment

TeSys GY "dual tariff" contactors

Setting-up precautions

The contactor controls must be bounce free. If not, connect a coil suppression block **1** (GAP 21 or 23) across the coil terminals ≤ 250 V.

When several contactors which operate at the same time are mounted side by side, a GAC 5 ventilation 1/2 module **2** must be fitted every 2 contactors.

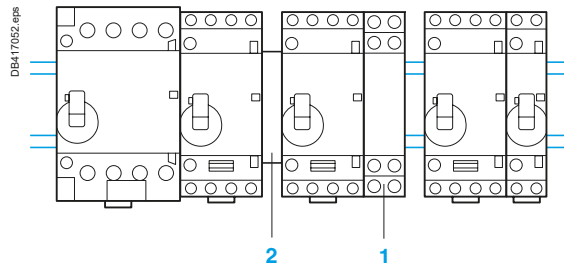

It is advisable to mount electronic units at the bottom of the modular panel and to separate them from electromechanical units by a space equal to one module **3** or by 2 ventilation 1/2 modules GAC 5.

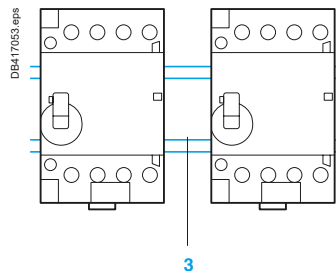

Derating of contactors mounted in a modular enclosure if the temperature within the enclosure is > 40 °C.

Contactor rating	40 °C	50 °C	60 °C ⁽¹⁾
16 A	16 A	14 A	13 A
25 A	25 A	22 A	20 A
40 A	40 A	36 A	32 A
63 A	63 A	57 A	50 A

⁽¹⁾ Ventilation 1/2 module must be fitted.

Modular equipment

TeSys GY "dual tariff" contactors

Environment						
Type			GY 16	GY 25	GY 40	GY 63
Rated insulation voltage (Ui)	Conforming to IEC 61095	V	500			
	Conforming to VDE 0110	V	500			
Rated impulse withstand voltage (Uimp)		kV	4 in enclosure			
Conforming to standards			IEC 61095 and IEC 60947-5-1 for auxiliary contacts			
Product certifications			NF-USE, VDE, CEBEC, ÖVE			
Degree of protection	Conforming to IEC 60529		Protection against direct finger contact IP 20 open, IP 40 in enclosure			
Ambient air temperature around the device	Storage	°C	-40...+70			
	Operation	°C	-5...+50 (0.85...1.1 Uc)			
Maximum operating altitude	Without derating	m	3000			
Operating positions	Without derating		±30° in relation to normal vertical mounting plane			
Shock resistance 1/2 sine wave = 11 ms	Contacteur open		10 gn			
	Contacteur closed		15 gn			
Vibration resistance 5...300 Hz	Contacteur open		2 gn			
	Contacteur closed		3 gn			
Flame resistance			Conforming to IEC 61095			

Pole characteristics						
Number of poles			2, 3 or 4			
Rated operational current (Ie) (Ue ≤ 440 V)	In AC-7a (heating)	A	16	25	40	63
	In AC-7b (motor control)	A	5	8.5	15	25
Rated operational voltage (Ue)	Up to	V	250 - 2-pole contactors, 415 - 3 and 4-pole contactors			
Frequency limits	Of the operating current	Hz	400			
Conventional thermal current (Ith)	θ ≤ 50 °C	A	16	25	40	63
Rated breaking and making capacity	Conforming to IEC 61095 (AC-7b) I rms 400 V 3-phase	A	40	68	120	200
Short time rating with no current flow for the previous 15 minutes with θ ≤ 40 °C	For 10 s	A	128	200	320	504
	For 30 s	A	40	62	100	157
Short-circuit protection by fuse or circuit breaker U ≤ 440 V						
gl fuse		A	16	25	40	63
Circuit breaker I²t (at 3 kA rms prospective)	230V	A²s	5000	10000	16000	18000
	400V	A²s	9000	14000	17500	20000
Electrical durability in operating cycles	AC-7a, AC-7b		100000	100000	100000	100000
Average impedance per pole	At Ith and 50 Hz	mΩ	2.5	2.5	2	2
Power dissipated per pole	For the above operational currents	W	0.65	1.6	3.2	8
Maximum cabling c.s.a.						
Flexible cable without cable end	1 conductor	mm²	6	6	25	25
	2 conductors	mm²	4	4	16	16
Flexible cable with cable end	1 conductor	mm²	6	6	16	16
	2 conductors	mm²	1.5	1.5	4	4
Solid cable without cable end	1 conductor	mm²	6	6	25	25
	2 conductors	mm²	4	4	6	6
Tightening torque	Power circuit connections	N.m	0.8	0.8	3.5	3.5

Modular equipment

TeSys GY "dual tariff" contactors

Control circuit characteristics					
Type			GY 16, GY 25 single or 2-pole	GY 16, GY 25 3 or 4-pole GY 40, GY 63 2-pole	GY 40, GY 63 3 or 4-pole
Rated control circuit voltage (Uc)	50 or 60 Hz	V	12...240 V, for other voltages, please consult your Regional Sales Office		
Control voltage limits ($\theta \leq 50$ °C) 50 Hz coils	Operational		0.85...1.1 Uc		
	Drop-out		0.2...0.75 Uc		
Average consumption at 20 °C and at Uc ~ 50 Hz	Inrush	VA	15	34	53
	Sealed	VA	3.8	4.6	6.5
Heat dissipation	50/60 Hz	W	1.3	1.6	2.1
Operating time	Closing "C"	ms	10 ... 30		
	Opening "O"	ms	10 ... 25		
Mechanical durability	In operating cycles		10 ⁶		
Maximum operating rate at ambient temperature ≤ 50 °C	In operating cycles per hour		300		
Maximum cabling c.s.a.	Flexible cable without cable end	1 or 2 conductors	mm ²	2.5	
	Flexible cable with cable end	1 conductor	mm ²	2.5	
		2 conductors	mm ²	1.5	
	Solid cable without cable end	1 or 2 conductors	mm ²	1.5	
Tightening torque		N.m	0.8		
Instantaneous auxiliary contact characteristics					
Rated operational voltage (Ue)	Up to	V	250		
Rated insulation voltage (Ui)	Conforming to IEC 60947-5	V	500		
	Conforming to VDE 0110	V	500		
Conventional thermal current (Ith)	For ambient $\theta \leq 50$ °C	A	5		
Mechanical durability	In operating cycles		10 ⁶		
Maximum cabling c.s.a.	Flexible or solid conductor	mm ²	2.5		
Tightening torque		N.m	0.8		

Modular equipment

TeSys GY "dual tariff" contactors

Dimensions

"Dual tariff" contactors

Common side view

GY 1620
GY 2520

1 module

GY 2530, 2540

2 modules

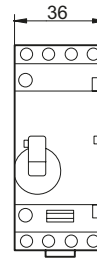
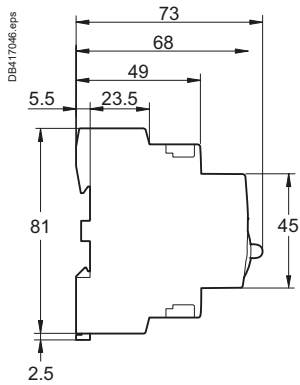

Common side view

GY 4020
GY 6320

2 modules

GY 4030, 4040
GY 6330, 6340

3 modules

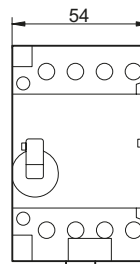
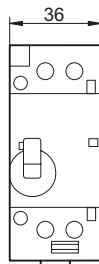
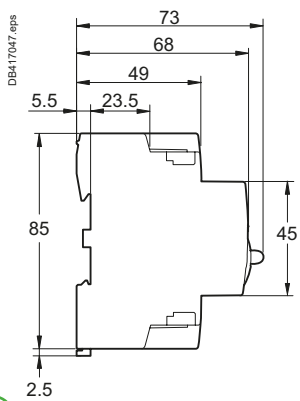

Modular equipment

TeSys GY "dual tariff" contactors

Dimensions

Auxiliary contacts

GAC 0511, 0531 and 0521

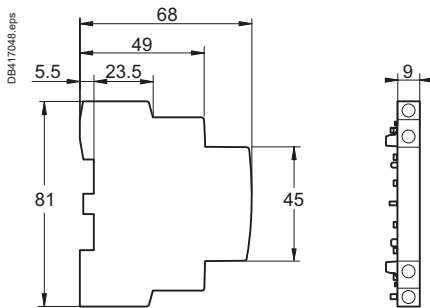

Coil suppression block

GAP 21 and 23

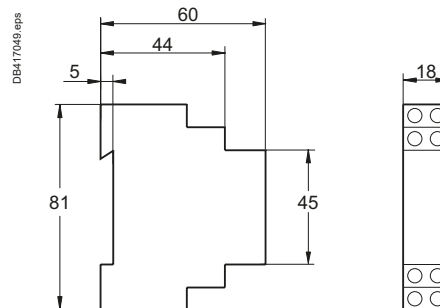

Clip-on ventilation 1/2 module

GAC 5

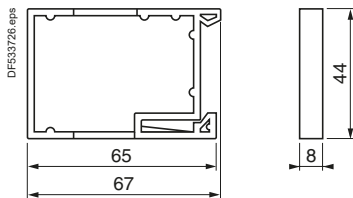

Schemes

Contactors

GY ●●20

GY ●●30

GY ●●40

GY ●●11

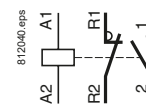
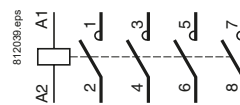
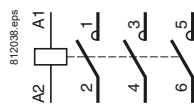
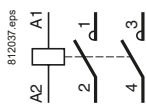

Auxiliary contacts

GAC 0521

GAC 0531

GAC 0511

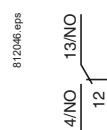
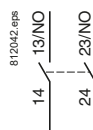
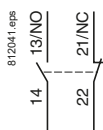



GF 1611M7

Presentation

TeSys GF impulse relays are designed for use in modular enclosures.

They feature:

■ Easy installation:

- quick clip-on fixing and locking onto 35 mm omega rail
- easy connection by means of ready-to-tighten captive, pozidrive screw terminals.

■ Compact size

Units have a common depth of 60 mm and width of 18 mm.

■ User safety:

- live parts protected against direct finger contact
- completely safe operation
- state indication on front panel.

Standards

This range of modular impulse relays has been designed taking into account the requirements of international standard IEC 60669-2.

This standard is specific to "Impulse relays".

Conformity with this standard makes it possible to obtain the following quality labels without the need for additional tests: NF-USE, VDE, CEBEC, etc.

Functions

Modular impulse relays are designed for opening and closing of circuits which are remotely controlled by impulses. The position is mechanically maintained.

These impulse relays are used in lighting circuits when there are more than two switching points.

Power switching

TeSys GF impulse relays have multiple applications in industrial, agricultural and commercial premises, hospitals and the home, i.e. wherever switching of a specific lighting supply is required.

Selection for lighting and heating circuits - TeSys GF

Modular equipment

TeSys GF impulse relays

Lighting circuits

Fluorescent lamps with starter

Single fitting	Non corrected			With parallel correction		
	18	36	58	18	36	58
Power in W	18	36	58	18	36	58
Number of lamps	70	35	21	50	25	16

Twin fitting

With series correction

Twin fitting	With series correction		
	2 x 18	2 x 36	2 x 58
Power in W	2 x 18	2 x 36	2 x 58
Number of lamps	56	28	17

Incandescent lamps: filament lamps

Power in W	40	60	75	100	200
Number of lamps	40	25	20	16	8

Incandescent lamps: halogen lamps

Power in W	300	500	1000	1500
Number of lamps	5	3	1	1

Incandescent lamps: very low voltage halogen lamps

Power in W	20	50	75	100
Number of lamps	70	28	19	4

Low pressure sodium vapour lamps

Non corrected

Power in W	55	90	135	180
Number of lamps	24	15	10	7

High pressure sodium vapour lamps

Non corrected

Power in W	250	400	1000
Number of lamps	5	3	1

Heating circuits

Single-phase 230 V, 2-pole

Power in kW	3.6
-------------	-----

Modular equipment

TeSys GF impulse relays

Environment			
Rated insulation voltage (Ui)	Conforming to IEC 60947-1-5	V	400
	Conforming to VDE 0110	V	400
Rated impulse withstand voltage (Uimp)		kV	4 in enclosure
Conforming to standards			IEC 60669-1 and 60669-2
Product certifications			NF-USE, CEBC, ASE, KEMA, N, S, D, FI, VDE
Degree of protection	Conforming to IEC 60529		Protection against direct finger contact IP 20 open, IP 40 in enclosure
Ambient air temperature around the device	Storage	°C	-40...+80
	Operation	°C	-20...+50
Maximum operating altitude	Without derating	m	2000
Operating positions	Without derating		±90° in relation to normal vertical mounting plane
Shock resistance 1/2 sine wave = 10 ms	Impulse relay open		Please consult your Regional Sales Office
	Impulse relay closed		Please consult your Regional Sales Office
Vibration resistance 5...300 Hz	Impulse relay open		4 gn
	Impulse relay closed		4 gn

Pole characteristics							
Number of poles			1 or 2				
Rated operational current (Ie) (Ue ≤ 250 V)	In AC-7a (heating)	A	16				
Rated operational voltage		V	250				
Conventional thermal current (Ith)	θ ≤ 50 °C	A	16				
Permissible short time rating no current flowing for preceding 15 minutes with θ ≤ 40 °C	For 1 s	A	320				
	For 10 s	A	96				
	For 30 s	A	48				
Short-circuit protection by fuse or circuit breaker	gl fuse	A	16				
	Circuit breaker I ² t (at 3 kA rms prospective)	A ² s	5000				
Average impedance per pole	At Ith and 50 Hz	mΩ	4				
Power dissipated per pole		W	1				
Maximum cabling c.s.a.	Flexible cable without cable end	1 conductor	mm ²	Min.	0.5	Max.	6
		2 conductors	mm ²	0.5	4		
	Flexible cable with cable end	1 conductor	mm ²	0.5	6		
		2 conductors	mm ²	0.5	4		
	Solid cable without cable end	1 conductor	mm ²	0.5	6		
		2 conductors	mm ²	0.5	4		
Tightening torque	Power circuit connections	N.m	0.8				

Modular equipment

TeSys GF impulse relays

Control circuit characteristics				
Rated control circuit voltage (Uc)		V	12...240 V, for other voltages, please consult your Regional Sales Office	
Control voltage limits ($\theta < 50\text{ }^{\circ}\text{C}$)	Operating threshold, dual frequency 50/60 Hz	V	0.85...1.1 Uc	
Average consumption at 20 °C and at Uc	Inrush at 50 Hz	VA	19	
Operating time	Closing "C"	ms	70	
	Opening "O"	ms	70	
Minimum impulse time		ms	70	
Mechanical durability			10 ⁶ operating cycles	
Electrical durability	AC-21		200000 operating cycles	
	AC-22		100000 operating cycles	
Maximum operating rate	Operating cycles per hour		900	
Maximum cabling c.s.a.	Flexible cable without cable end	1 or 2 conductors	mm²	2.5
		1 conductor	mm²	2.5
	Flexible cable with cable end	2 conductors	mm²	1.5
		1 or 2 conductors	mm²	1.5
	Solid cable without cable end	1 or 2 conductors	mm²	1.5
Tightening torque		N.m	0.8	

Dimensions

GF 1610, GF 1611, GF 1620

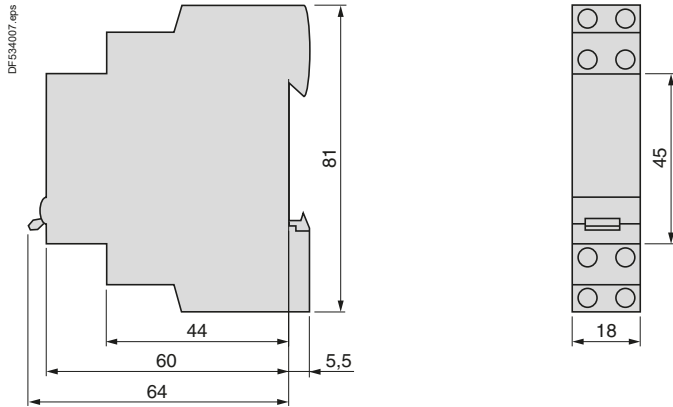

Schemes

GF 1610

GF 1611

GF 1620

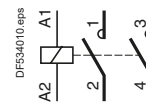
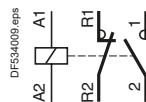
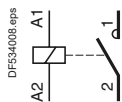

Technical information

Tests according to standard utilisation categories conforming to IEC 60947-4-1 and 5-1

Contactors													
a.c. supply													
Typical applications	Utilisation category	Electrical durability: making and breaking conditions						Occasional duty: making and breaking conditions					
		Making			Breaking			Making			Breaking		
		I	U	cos φ	I	U	cos φ	I	U	cos φ	I	U	cos φ
Resistors, non inductive or slightly inductive loads	AC-1	1e	Ue	0.95	1e	Ue	0.95	1.5 1e	1.05 Ue	0.8	1.5 1e	1.05 Ue	0.8
Motors													
Slip ring motors: starting, breaking.	AC-2	2.5 1e	Ue	0.65	2.5 1e	Ue	0.65	4 1e	1.05 Ue	0.65	4 1e	1.05 Ue	0.65
Squirrel cage motors: starting, breaking whilst motor running.	AC-3	1e ≤ ⁽¹⁾	Ue	0.65	1 1e	0.17 Ue	0.65	10 1e	1.05 Ue	0.45	8 1e	1.05 Ue	0.45
		1e > ⁽²⁾	Ue	0.35	1 1e	0.17 Ue	0.35	10 1e	1.05 Ue	0.35	8 1e	1.05 Ue	0.35
Squirrel cage motors: starting, reversing, inching	AC-4	1e ≤ ⁽¹⁾	Ue	0.65	6 1e	Ue	0.65	12 1e	1.05 Ue	0.45	10 1e	1.05 Ue	0.45
		1e > ⁽²⁾	Ue	0.35	6 1e	Ue	0.35	12 1e	1.05 Ue	0.35	10 1e	1.05 Ue	0.35
d.c. supply													
Typical applications	Utilisation category	Making			Breaking			Making			Breaking		
		I	U	L/R (ms)	I	U	L/R (ms)	I	U	L/R (ms)	I	U	L/R (ms)
Resistors, non inductive or slightly inductive loads	DC-1	1e	Ue	1	1e	Ue	1	1.5 1e	1.05 Ue	1	1.5 1e	1.05 Ue	1
Shunt wound motors: starting, reversing, inching	DC-3	2.5 1e	Ue	2	2.5 1e	Ue	2	4 1e	1.05 Ue	2.5	4 1e	1.05 Ue	2.5
Series wound motors: starting, reversing, inching	DC-5	2.5 1e	Ue	7.5	2.5 1e	Ue	7.5	4 1e	1.05 Ue	15	4 1e	1.05 Ue	15
Control relays and auxiliary contacts													
a.c. supply													
Typical applications	Utilisation category	Electrical durability: making and breaking conditions						Occasional duty: making and breaking conditions					
		Making			Breaking			Making			Breaking		
		I	U	cos φ	I	U	cos φ	I	U	cos φ	I	U	cos φ
Electromagnets													
≤ 72 VA	AC-14	-	-	-	-	-	-	6 1e	1.1 Ue	0.7	6 1e	1.1 Ue	0.7
> 72 VA	AC-15	10 1e	Ue	0.7	1e	Ue	0.4	10 1e	1.1 Ue	0.3	10 1e	1.1 Ue	0.3
d.c. supply													
Typical applications	Utilisation category	Making			Breaking			Making			Breaking		
		I	U	L/R (ms)	I	U	L/R (ms)	I	U	L/R (ms)	I	U	L/R (ms)
Electromagnets	DC-13	1e	Ue	6 P ⁽³⁾	1e	Ue	6 P ⁽³⁾	1.1 1e	1.1 Ue	6 P ⁽³⁾	1.1 1e	1.1 Ue	6 P ⁽³⁾

(1) 1e ≤ 17 A for electrical durability, 1e ≤ 100 A for occasional duty.

(2) 1e > 17 A for electrical durability, 1e > 100 A for occasional duty.

(3) The value 6 P (in watts) is based on practical observations and is considered to represent the majority of d.c. magnetic loads up to the maximum limit of P = 50 W i.e. 6 P = 300 ms = L/R. Above this, the loads are made up of smaller loads in parallel. The value 300 ms is therefore a maximum limit whatever the value of current drawn.

TeSys contactors

For the North American market

Conforming to UL and CSA

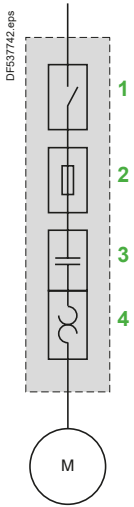

- 1 Motor Disconnect (Disconnect switch)
- 2 Motor Branch Circuit Protection (Short-circuit protection)
- 3 Motor Controller (Contactor)
- 4 Motor Overload Protection (Thermal overload relay)

Starters for the North American market

In recent years, the North American market has started to harmonise UL, CSA and ANCE standards, as well as the industrial installation codes provided by national regulations (NEC for the United States, CEC for Canada and MEC for Mexico). ⁽¹⁾ Major improvements, carried out by the Canena ⁽²⁾ are aimed at harmonising product requirements based on IEC ⁽³⁾ standards. However, the North American codes use specific terminology for defining the functions of a starter. These functions can be fulfilled by standard IEC products, accompanied by appropriate certifications.

Combination Starters

Combination Starters are the most common type of packaged motor starter. They are called "Combination" because of their structure and their combined functions. The figure opposite shows the four combined functions that constitute a complete motor starter circuit, defined as a "Motor branch circuit" by the NEC (US National Electric Code) in article 430. Standard UL508 currently gives different types of combination starter that meet the requirements of a "Motor branch circuit".

Type E, called "self-protected combination starter", covers all these functions and can be controlled manually (thermal-magnetic circuit breaker) or remotely (starter-controller). Type E starters withstand faults within their declared nominal rating without sustaining damage, after which they can be put back into service. In addition, they can withstand more severe short-circuit and durability performance tests without welding or excessive wear of the contact tips.

Type F, called "Combination motor starter", consists of a type E manual starter (thermal-magnetic circuit breaker) combined with a contactor. These starters are evaluated by means of basic short-circuit tests, but are not considered as "self-protected".

For this combination, the type E starter must be marked "Combination Motor Controller when used with ...", followed by the reference of the load side contactor.

⁽¹⁾ **UL**: Underwriters Laboratories, **CSA**: Canadian Standards Association, **ACNE**: Association of Standardization and Certification, **NEC**: National Electric Code, **CEC**: Canadian Electrical Code, **MEC**: Mexican Electrical Code.
⁽²⁾ **Canena**: Council for Harmonization of Electrotechnical Standardization of North America.
⁽³⁾ **IEC**: International Electrotechnical Commission.

TeSys contactors

For the North American market

Conforming to UL and CSA

Control panels

To help users properly coordinate their motor control equipment with their distribution system in the event of a fault, article 409 of the 2005 NEC requires panel builders to list the short-circuit withstand rating of their motor control panels. According to standard UL508A, manufacturers must use the short-circuit withstand value of the lowest rated device as the nominal withstand rating of the panel, unless the devices have been tested together for a higher coordinated rating. The minimum “**short-circuit current rating**” (SCCR), on motor control components for horsepower ratings of 50 hp or below is 5000 A.

Using a **type E** or **type F** combination starter eliminates the coordination problems of using individual components for the “motor branch circuit protection”, “motor controller” and “motor overload protection” functions. The panel builder uses the declared short-circuit current rating for the combination starter. This value is generally higher than 5000 A. This makes it easier to list the short-circuit current ratings and to check the compatibility of a UL508A motor control panel within a given distribution system.

Group protection

Article 430.53 of the NEC allows a single short-circuit protection device to be used for more than one motor circuit if the components used are marked and listed for such use.

Components suitable for use in group protection, known as “**motor group installations**”, can be marked in one of the following two ways:

Case n° 1

The contactor and the motor overload relay are both listed as suitable for group installation.

An inverse time circuit breaker can be used as the short-circuit protection device if it is also listed as suitable for group installation.

The panel builder must therefore make sure that the short-circuit protection device selected (fuses or inverse time circuit breaker) does not exceed the value allowed by article 430.40 for the smallest overload relay used in the circuit.

Once these conditions have been met, the panel builder can reduce the size of the conductor connecting the short-circuit protection device to the individual motor contactor/overload relay, to one third of the size of the upstream circuit conductor supplying the protection device.

The panel builder must limit the length of the motor starter conductor (connecting the short-circuit protection device to the motor contactor/overload relay) to a maximum of 7.6 m (25 feet).

Case n° 2

The motor contactor and overload relay are listed as suitable for “**tap conductor protection**” in group installations.

This category allows the panel designer to reduce the size of the conductor connecting the short-circuit protection device to the individual motor contactor/overload relay, to one tenth of the size of the upstream circuit conductor supplying the protection device.

The designer must limit the length of this conductor to a maximum of 3.05 m (10 feet).

In both cases, the supply circuits must not be less than 125 % of the connected motor FLA (Full Load Amps) rating.

For panel builders, using **type F** combination starters in group installations simplifies group motor considerations.

Each starter is a fully coordinated motor branch circuit.

The panel builder follows the same NEC requirements for sizing the supply conductors as those required for single motor branch circuits.

The size of the supply conductors can be reduced in accordance with the specifications of article 430.28.

This allows the same flexibility in conductor sizing as that offered in article 430.53 (D), without a requirement to check the short-circuit protection rating marked on the components and the overload relay limit.

A UL508A panel does not need a short-circuit protection device when each motor starter installed is a **type F**.

The upstream short-circuit protection device supplying the starter protects the panel. The panel builder only has to consider the panel/enclosure disconnect requirements specified by the NEC or local codes.

