



Easy Series

Solutii de protectie si control

Oferta de produse Easy de la A la Z

se.com/ro

Life Is On

Schneider
Electric

A woman with dark curly hair is shown in profile, focused on her work. She is using a green-handled screwdriver to adjust a component on a complex electrical control panel. The panel is densely packed with various electrical components, including green terminal blocks, switches, and wiring. In the background, a large white circular fan is visible, suggesting a server room or industrial control environment. The overall scene conveys a sense of technical expertise and precision.

Eficienta in protectie si automatizare

Catalogul in care veti gasi toate componentele necesare pentru a furniza panouri de protectie si control sau masini industriale de inalta performanta.

Cresteti eficienta in selectarea echipamentelor cu ajutorul catalogului Easy.

Noile produse

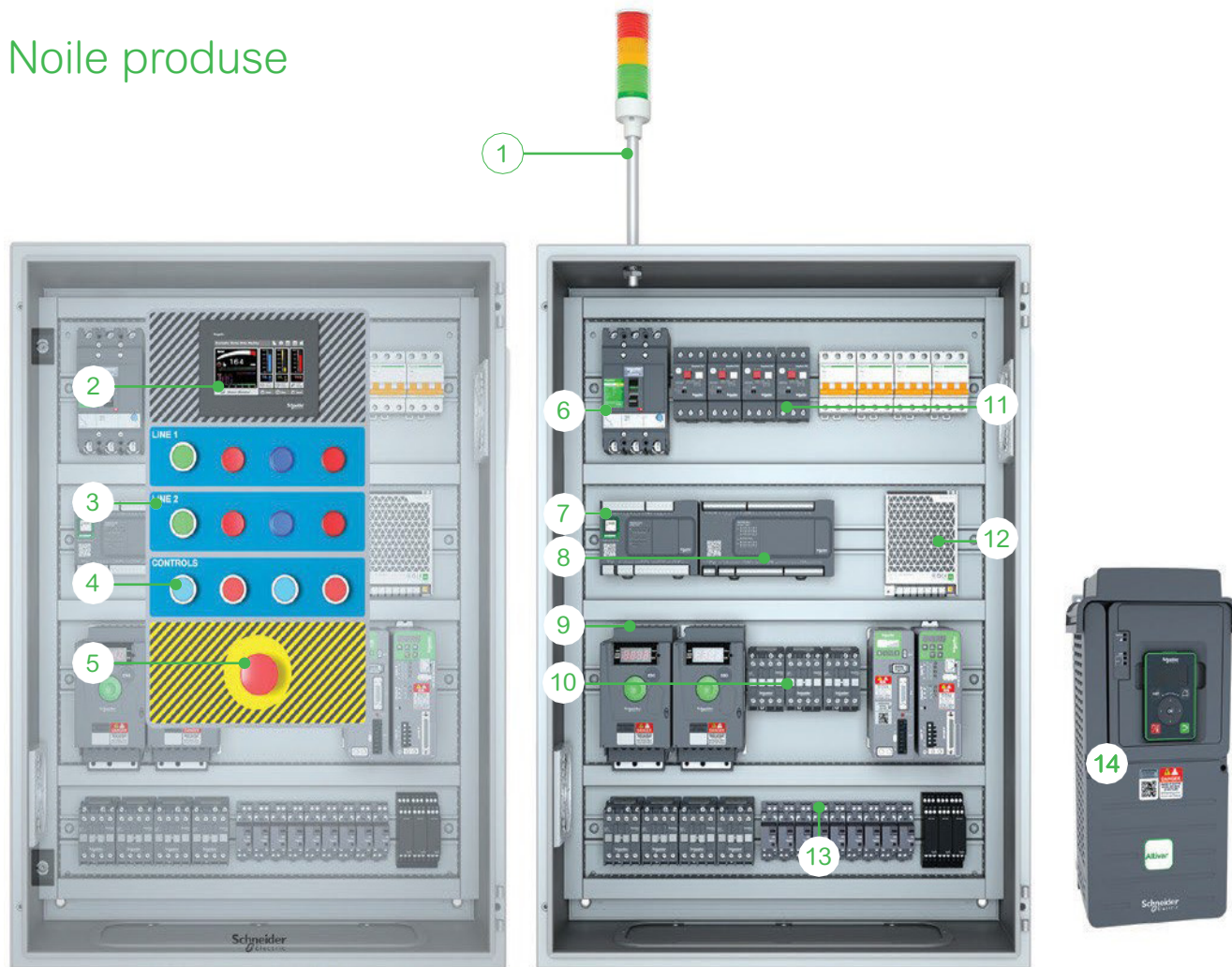

- | | |
|--|---|
| 1 Coloane luminoase Easy Harmony XVG | 9 Variatoare de viteza Easy Altivar ATV310 |
| 2 Terminale programabile (HMI) Easy Harmony ET6 | 10 Contactoare EasyPact TVS |
| 3 Panouri de legenda personalizabile Harmony | 11 Intreruptoare magneto-termice EasyPact TVS |
| 4 Butoane de comanda metalice Easy Harmony XA2 | 12 Surse de alimentare Easy Modicon ABL2 |
| 5 Butoane de avarie | 13 Relee electromecanice Easy Harmony RXM*LB |
| 6 Protectia sistemelor de distributie EasyPact CVS | 14 Variatoare de viteza Easy Altivar ATV610 |
| 7 Controlere logice Easy Modicon M100 | 15 PC-uri industriale Easy Harmony Smart iPC |
| 8 Controlere logice Easy Modicon M200 | |



Puteti afla mai multe detalii despre seria de produse Easy de la partenerii nostri oficiali!

Continut general

01. Control si semnalizare Easy Harmony	6
02. Terminale programabile Easy Harmony ET6.....	13
03. Variatoare de viteza Easy Altivar	17
04. Relee electromecanice Easy Harmony.....	24
05. Surse de alimentare Easy Modicon	26
06. Intreruptoare EasyPact de la 100 A la 3200 A	28
07. Solutii de porniri motoare EasyPact	39
08. Controlere Logice Easy Modicon	44
09. Panouri industriale Easy Harmony Smart iPC...	49
10. Solutii de control pentru motoarele trifazate asincrone.....	51



01. Control si semnalizare Easy Harmony

Easy Harmony XVG - Coloane luminoase Ø 60



1 Cu fixare directa

Sursa de lumina		LED pentru lumina constanta				
Culori (1)		● Rosu, ● Verde	● Rosu, ● Portocaliu, ● Verde		● Rosu, ● Portocaliu, ● Verde, ● Albastru	
Tensiune		24 VAC/VDC	220~240VAC	24 VAC/VDC	220~240VAC	24 VAC/VDC
Referinta	Fara sonerie, IP53	XVGB2W	XVGM2W	XVGB3W	XVGM3W	XVGB4W
	Cu sonerie, IP42	XVGB2SW	XVGM2SW	XVGB3SW	XVGM3SW	XVGB4SW

2 Cu montare directa pe tub de aluminiu

Sursa de lumina		LED pentru lumina constanta				
Culori (1)		● Rosu, ● Verde	● Rosu, ● Portocaliu, ● Verde		● Rosu, ● Portocaliu, ● Verde, ● Albastru	
Tensiune		24 VAC/VDC	220~240VAC	24 VAC/VDC	220~240VAC	24 VAC/VDC
Referinta	Fara sonerie, IP23	XVGB2T	XVGM2T	XVGB3T	XVGM3T	XVGB4T
	Cu sonerie, IP23	XVGB2ST	XVGM2ST	XVGB3ST	XVGM3ST	XVGB4ST

3 Cu montare pe tub de aluminiu si suport in L

Sursa de lumina		LED pentru lumina constanta				
Culori (1)		● Rosu	● Rosu, ● Verde	● Rosu, ● Portocaliu, ● Verde	● Rosu, ● Portocaliu, ● Verde, ● Albastru	
Tensiune		24 VAC/VDC	220~240VAC	24 VAC/VDC	220~240VAC	24 VAC/VDC
Referinta	Lumina intermitenta cu sonerie	XVGB1SFA	XVGM1SFA	-	-	-
	Fara sonerie IP23	XVGB1A	XVGM1A	XVGB2	XVGM2	XVGB3
	Cu sonerie, IP23	XVGB1SA	XVGM1SA	XVGB2S	XVGM2S	XVGB3S

4 Cu montare pe tub de aluminiu si placa de fixare

Sursa de lumina		LED pentru lumina constanta				
Culori (1)		● Rosu, ● Verde	● Rosu, ● Portocaliu, ● Verde		● Rosu, ● Portocaliu, ● Verde, ● Albastru	
Tensiune		24 VAC/VDC	220~240VAC	24 VAC/VDC	220~240VAC	24 VAC/VDC
Referinta	Fara sonerie, IP53	XVGB2H	XVGM2W	XVGB3H	XVGM3H	XVGB4H
	Cu sonerie, IP42	XVGB2SH	XVGM2SW	XVGB3SH	XVGM3SH	XVGB4SH

5 Cu montare pe tub de aluminiu si suport pliabil

Sursa de lumina		LED pentru lumina constanta				
Culori (1)		● Rosu	● Rosu, ● Verde	● Rosu, ● Portocaliu, ● Verde	● Rosu, ● Portocaliu, ● Verde, ● Albastru	
Tensiune		24 VAC/VDC	220~240VAC	24 VAC/VDC	220~240VAC	24 VAC/VDC
Referinta	Lumina intermitenta cu sonerie	XVGB1SMFA	XVGM1SMFA	-	-	-
	Fara sonerie, IP53	XVGB1MA	XVGM1MA	XVGB2M	XVGM2M	XVGB3M
	Cu sonerie, IP42	XVGB1SMA	XVGM1SMA	XVGB2SM	XVGM2SM	XVGB3SM

6 Accesorii (pentru asociere)

Culoare	● Alb
Tipul de unitate	Suport de montare rabatabil pentru montarea tubului de sustinere
Referinta	XVGZ02 (2)
	Suport de montare pe perete
	XVMZ02W (3)

(1) Culorile sunt enumerate in aceeasi ordine ca si ordinea de montare a unitatilor iluminate (de sus in jos).

(2) Compatibil cu XVGBpH, XVGBpSH, XVGBpMp, XVGBpSMp, XVGMpH, XVGMpSH, XVGMpMp, XVGMpSM.

(3) Compatibil cu XVGBpT, XVGBpST, XVGMpT, XVGMpST.

Easy Harmony XA2 - Butoane din plastic



1 Butoane de control fara marcaj

Culoare	○ Alb	● Negru	● Verde	● Rosu	● Galben	● Albastru	
Contact	NO			NC	NO		
Conexiune	Terminale cu clema si surub						
Produs complet pentru montare standard	Cu revenire	XA2EA11	XA2EA21	XA2EA31	XA2EA42	XA2EA51	XA2EA61
	Cu retinere	-	XA2EH021	XA2EH031	XA2EH042	XA2EH051	XA2EH061

2 Butoane de control cu marcaj

Culoare	○ Alb	● Negru	● Verde	● Rosu	● Rosu	
Marcaj	A	↑	"I" (alb)	"O" (alb)	"STOP" (alb)	
Contact	NO			NC	NC	
Conexiune	Terminale cu clema si surub					
Produs complet pentru montare standard	XA2EA3341	XA2EA3351	XA2EA3311	XA2EA4322	XA2EA4342	



3 Butoane tip ciuperca de avarie

Culoare	● Rosu				
Diametru	Ø 40	Ø 30	Ø 40	Ø 60	Ø 30
Contact	NC Apasa-trage	NC Revenire prin rasucire			
Conexiune	Terminale cu clema si surub				
Produs complet pentru montare standard	XA2ET42	XA2ES442	XA2ES542	XA2ES642	XA2ES422

4 Butoane tip ciuperca cu revenire

Culoare	● Negru	● Verde	● Rosu	● Galben	● Negru
Diametru	Ø 40	Ø 40	Ø 40	Ø 40	Ø 60
Contact	NO		NC	NO	
Conexiune	Terminale cu clema si surub				
Produs complet pentru montare standard	XA2EC21	XA2EC31	XA2EC42	XA2EC51	XA2ER21



5 Butoane selectoare

Pozitii	2 ∨	2 ∇	2 ∨	3 ∨	3 ∇	
Contact	NO		NO + NC	2 NO		
Conexiune	Terminale cu clema si surub					
Produs complet pentru montare standard	Maner standard	XA2ED21	XA2ED41	XA2ED25	XA2ED33	XA2ED53
	Maner lung	XA2EJ21	-	XA2EJ25	XA2EJ33	XA2EJ53

6 Comutatoare cu cheie

Pozitii	2 ∨	2 ∇	2 ∇	3 ∇	3 ∨	3 ∨	
Contact	NO	2 NO					
Conexiune	Terminale cu clema si surub						
Produs complet pentru montare standard	Comutator cu cheie (No. 455)	XA2EG21	XA2EG43	XA2EG63	XA2EG73	XA2EG33	XA2EG03

Easy Harmony XA2 - Butoane din plastic



1 Lampa cu LED integrat

Culoare	Alb	Verde	Rosu	Portocaliu	Albastru	Galben	Bicolor(Rosu/Verde)	
Conexiune	Terminale cu clema si surub							
Produs complet	12 V AC/DC	XA2EVJ1LC	XA2EVJ3LC	XA2EVJ4LC	XA2EVJ5LC	XA2EVJ6LC	XA2EVJ8LC	-
	24 V AC/DC	XA2EVB1LC	XA2EVB3LC	XA2EVB4LC	XA2EVB5LC	XA2EVB6LC	XA2EVB8LC	XA2EVB34LC
	30 V AC/DC	XA2EVC1LC	XA2EVC3LC	XA2EVC4LC	XA2EVC5LC	XA2EVC6LC	XA2EVC8LC	-
	48 V AC/DC	XA2EVE1LC	XA2EVE3LC	XA2EVE4LC	XA2EVE5LC	XA2EVE6LC	XA2EVE8LC	-
	63.5 V AC/DC	XA2EVEE1LC	XA2EVEE3LC	XA2EVEE4LC	XA2EVEE5LC	XA2EVEE6LC	XA2EVEE8LC	-
	110 V AC/DC	XA2EVF1LC	XA2EVF3LC	XA2EVF4LC	XA2EVF5LC	XA2EVF6LC	XA2EVF8LC	-
	220...230 V AC	XA2EVM1LC	XA2EVM3LC	XA2EVM4LC	XA2EVM5LC	XA2EVM6LC	XA2EVM8LC	XA2EVM34LC
	220 V DC	XA2EVM1LC	XA2EVM3LC	XA2EVM4LC	XA2EVM5LC	XA2EVM6LC	XA2EVM8LC	-
	380...400 V AC	XA2EVQ1LC	XA2EVQ3LC	XA2EVQ4LC	XA2EVQ5LC	XA2EVQ6LC	XA2EVQ8LC	-

2 Indicatoare cu LED-uri integrate

Tip		Indicator comutator de izolare	Indicator intreruptor de circuit	Indicator PE
Produs complet	110 V AC	XA2EVF34SPC	XA2EVM34SPC	XA2EVQ34SPC
	220 V AC	XA2EVF34BPC	XA2EVM34BPC	XA2EVQ34BPC
(Verde/Rosu)	380 V AC	XA2EVF34GPC	XA2EVM34GPC	XA2EVQ34GPC

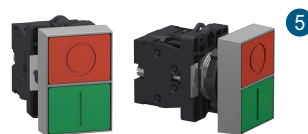
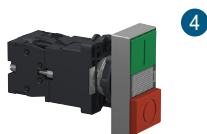

3 Butoane luminoase cu LED integrat

Culoare	Alb	Verde	Rosu	Galben	Albastru	Rosu	
Contact	NO					NC	
Conexiune	Terminale cu clema si surub						
Produs complet	24 V AC/DC	XA2EW31B1	XA2EW33B1	XA2EW34B1	XA2EW35B1	XA2EW36B1	XA2EW34B2
	220...230 V AC	XA2EW31M1	XA2EW33M1	XA2EW34M1	XA2EW35M1	XA2EW36M1	XA2EW34M2
	380...400 V AC	XA2EW31Q1	-	-	-	-	XA2EW34Q2

4 Butoane cu doua capete, cu revenire si lumina de control incorporata

Produs complet	24 V AC/DC	XA2EW7L3741B5			
(Verde/Rosu)	220...230 V AC	XA2EW7L3741M5			

5 Butoane cu doua capete standard, cu revenire

Produs complet	XA2EA7A3415			
(Verde/Rosu)	-			

Easy Harmony XA2 - Accesorii pentru butoanele din plastic

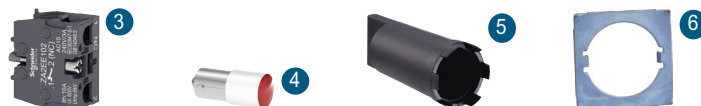

3 Functii de contact (pentru toate butoanele si comutatoarele XA2)

Tip	Functia de contact	
Contact	NO	NC
Conexiune	Terminale cu clema si surub	
Referinta	ZA2EE101	ZA2EE102

4 Becuri cu soclu BA 9s si accesorii asociate

Culoare	<input type="radio"/> Alb	<input type="radio"/> Verde	<input type="radio"/> Rosu	<input type="radio"/> Galben	<input type="radio"/> Albastru
Tensiune	24 VAC/VDC				
Referinta	DL1LED241	DL1LED243	DL1LED244	DL1LED245	DL1LED246

5 Instrument de strangere

Aplicare	Strangere piulita de fixare a butonului
Referinta	ZB5AZ905

6 Placa anti-rotatie

Aplicare	Impiedica rotatia butonului
Referinta	ZB5AZ902

Easy Harmony XB2 - Butoane din metal



1 Butoane de control nemarcate

Culoare	○ Alb	● Negru	● Verde	● Rosu	● Galben	● Albastru
Contact	NO			NC	NO	
Conexiune	Terminale cu clema si surub					
Produs complet pentru montare standard	XB2BA11C	XB2BA21C	XB2BA31C	XB2BA42C	XB2BA51C	XB2BA61C

2 Butoane de control marcate

Culoare	○ Alb	● Negru	● Verde	● Rosu
Marcaj	"Sageata"	"Sageata"	"I" (alb)	"O" (alb)
Contact	NO			
Conexiune	Terminale cu clema si surub			
Produs complet pentru montare standard	XB2BA3341C	XB2BA3351C	XB2BA3311C	XB2BA4322C

3 Butoane in relief nemarcate

Culoare	● Verde	● Rosu
Contact	NO	NC
Conexiune	Terminale cu clema si surub	
Produs complet pentru montare standard	XB2BL31C	XB2BL42C



1 Butoane cu protectie din silicon, nemarcate

Culoare	● Negru	● Verde	● Rosu
Contact	NO		NC
Conexiune	Terminale cu clema si surub		
Produs complet pentru montare standard	XB2BP21C	XB2BP31C	XB2BP42C

2 Butoane tip ciuperca cu revenire

Culoare	● Negru	● Verde	● Rosu	● Galben	● Negru
Diametru	Ø 40				Ø 60
Contact	NO		NC	NO	
Conexiune	Terminale cu clema si surub				
Produs complet pentru montare standard	XB2BC21C	XB2BC31C	XB2BC42C	XB2BC51C	XB2BR21C



1 Butoane de avarie (1)

Culoare	● Rosu
Diametru	Ø 40
Contact	NC Push -pull
Conexiune	Terminale cu clema si surub
Produs complet pentru montare standard	XB2BT842C

2 Butoane de avarie (1)

Culoare	● Rosu
Diameter of head	Ø 40
Contact	NC Push -pull
Conexiune	Terminale cu clema si surub
Produs complet pentru montare standard	XB2BT42C

(1) Butoanele de avarie pot functiona cu un maxim de 4 contacte instalate, doar 2 randuri de contacte.

Easy Harmony XB2 - Butoane din metal



Butoane selectoare

Pozitii	2 ∨	2 ∩	3 ∨	3 ∩	2 ∨			
Contact	NO	NO + NC	NO	NO + NC	2 NO			
Conexiune	Terminale cu clema si surub							
Produs complet pentru montare standard	1 Maner standard	XB2BD21C	XB2BD25C	XB2BD41C	XB2BD45C	XB2BD33C	XB2BD53C	XB2BD73C
	2 Maner lung	XB2BJ21C	XB2BJ25C	-	-	XB2BJ33C	XB2BJ53C	-

3 Comutatoare cu cheie (cheie tip 455)

Pozitii	2 ∨	2 ∩	2 ∩	3 ∨	3 ∩	3 ∩	
Conexiune	Terminale cu clema si surub						
Produs complet pentru montare standard	NO	XB2BG21C	XB2BG41C	XB2BG61C	-	-	-
	2 NO	-	-	-	XB2BG33C	XB2BG53C	XB2BG03C
	NO + NC	XB2BG25C	XB2BG45C	XB2BG65C	-	-	-



Butoane luminoase cu LED integrat

Culoare	○ Alb	● Verde	● Rosu	● Galben	● Albastru	
Contact	NO					
Conexiune	Terminale cu clema si surub					
Produs complet pentru montare standard	1 24 V AC/DC	XB2BW31B1C	XB2BW33B1C	XB2BW34B1C	XB2BW35B1C	XB2BW36B1C
	2 220...230 V AC	XB2BW31M1C	XB2BW33M1C	XB2BW34M1C	XB2BW35M1C	XB2BW36M1C



Joysticks

Mecanism	Cu revenire in pozitia initiala	Fara revenire in pozitia initiala
2 directii	XD2PA22CR	XD2PA12CR
4 directii	XD2PA24CR	XD2PA14CR



Sonarii

Caracteristici	Neiluminat 1	Iluminat 2
24 V AC/DC	XB2BSBC	XB2BSB4LC
220...230 V AC	XB2BSMC	XB2BSM4LC

Nota: Pentru lampile cu LED integrat, va rugam sa consultati gama Easy Harmony XA2.



02. Terminale programabile Easy Harmony ET6

Easy Harmony ET6 - Terminale programabile (HMI)



Modele Easy Harmony ET6 Modbus cu grad de protectie IP65

Dimensiunea ecranului	7" ¹	10" ²
Rezolutia ecranului (pixeli)	800 x 480 WVGA	1024 x 600 WSVGA
Ecran tactil sau tastatura	Ecran tactil	Ecran tactil
Software	Vijeo Designer Basic	Vijeo Designer Basic
Capacitatea de memorie	Memorie interna	256 MB
	Memorie de backup	128 KB
Comunicatie	Comunicatie seriala	Mufa SUB-D 9 pini, RS-232C (COM1) + Mufa SUB-D 9 pini, RS-422/RS485 (COM2)
	Conexiune USB	1x USB 2.0 Micro-B
Temperatura de operare	0...50 °C	0...50 °C
Certificari industriale	UL/cUL 61010-2-201, KC, EAC, UKCA, RCM, European RoHS/China RoHS, REACH, WEEE	
Decupaj (mm)	190 x 135	255 x 185
Dimensiuni (mm)	205.5 x 150.5 x 45	270.5 x 200.5 x 47
Referinta	HMIET6401	HMIET6500



Modele Easy Harmony ET6 ETH cu grad de protectie IP65

Dimensiunea ecranului	7" ³	10" ⁴	12" ⁵	15" ⁶
Rezolutia ecranului (pixeli)	800 x 480 WVGA	1024 x 600 WSVGA	1280 x 800 WXGA	1366 x 768 FWXGA
Ecran tactil sau tastatura	Ecran tactil			
Software	Vijeo Designer Basic V1.2 sau mai mult			
Capacitatea de memorie	Memorie interna	256 MB	256 MB	256 MB
	Memorie de backup	128 KB	128 KB	128 KB
Comunicatie	Port Ethernet	Ethernet 10/100BASE-TX		
	Comunicatie seriala	Mufa SUB-D 9 pini, RS-232C (COM1) + Mufa SUB-D 9 pini, RS-422/RS485 (COM2)		
	Conexiune USB	1 conector de tip A + 1 conector micro-B		
Temperatura de operare	0...50 °C	0...50 °C	0...50 °C	0...50 °C
Certificari industriale	UL/cUL 61010-2-201, KC, EAC, UKCA, RCM, European RoHS/China RoHS, REACH, WEEE			
Decupaj (mm)	190 x 135 mm	255 x 185 mm	295 x 217 mm	394 x 250 mm
Dimensiuni (mm)	206 x 151 x 45 mm	271 x 201 x 47 mm	311 x 233 x 50 mm	412 x 268 x 50 mm
Referinta	HMIET6400	HMIET6500	HMIET6600	HMIET6700

Easy Harmony ET6 - Software de programare si accesorii



Vijeo Designer Basic, software de programare pentru Harmony ET6

Compatibilitate	Toate terminalele programabile Easy Harmony ET6 (V1.2 sau o versiune superioara)
Referinta	Pentru a descarca acest software, vizitati site-ul web Schneider Electric



Piese de schimb

Descriere	Suruburi de fixare ¹	Conector de alimentare ²
Compatibilitate	Modele Easy Harmony ET6 de 7"-12"	Toate modelele Easy Harmony ET6
Referinta	HMIZGFIX3	HMIZGPWS1



Accesorii de conectare

Tipul de conexiune	1 conector USB micro-B (tata) + 1 conector USB micro-B (mama) ³	1 conector USB tip A (tata) + 1 conector USB tip A (mama) ⁴
Descriere	Cablu de extensie care ataseaza interfata USB (micro-B) la panoul frontal al incintei	Permite conectarea unui PC (port USB tip A) la terminalele Easy Harmony ET6 (port USB micro-B, toate modelele) pentru a transfera aplicatii dezvoltate cu Vijeo Designer Basic.
Lungimea cablului (m)	1	1,8
Referinta	HMIZSUSBB2	HMIZG936



Cabluri pentru conectarea terminalelor programabile (HMI) Easy Harmony ET6

Compatibilitatea gamei	Modicon M221, M241, M251, M262, M340, M218, M238, M258	Modicon M100, M200	Demaroare TeSys U/T, variatoare Altivar, demaroare Altistart, control al miscarii Lexium, Preventa XPS MC
Tipul de conexiune	1 conector tata RJ45 + 1 conector mama 9 way Sub-D ⁵	1 conector mama Sub-D + 1 cablu de legatura la celalalt capat ⁶	1 conector tata RJ45 + 1 conector mama cu 9 way Sub-D ⁷
Interfata	RS 485	-	Modbus
Protocol de comunicatie	-	-	Modbus
Compatibilitate	Toate terminale programabile Easy Harmony ET6		
Lungimea cablului (m)	2,5		
Referinta	XBTZ9008	XBTZG9722	XBTZ9008

Easy Harmony ET6 - Accesorii



Cabluri universale pentru PLC-uri

PLC-uri de la terți	Mitsubishi, Melsec			Omron, Sysmac		Siemens, Simatic	Cabluri personalizabile
Compatibilitate	Toate modelele Easy Harmony ET6						
Cabluri de conectare	Q Link (SIO)	Q CPU (SIO)	FX (CPU)	Link (SIO)	FINS (SIO)	MPI port, S7 200 S7 300/400	RS 422
Tipul de conexiune	9-pini SUB-D/ 9-pini SUB-D ①	9-pini SUB-D/mini-DIN ②		9-pini SUB-D/ 25-pini SUB-D ③	9-pini SUB-D/ 9-pini SUB-D ①		9-pini SUB-D ④
Interfata	RS 232C		RS 422	RS 232C		RS 485	RS 422
Lungimea cablului (m)	5						
Referinta	XBTZG9772	XBTZG9774	XBTZG9775	XBTZG9731	XBTZG9740	XBTZG9740	(1) XBTZG9722

(1) Cablu personalizat cu un conector Siemens PB 6ES7972-0Bx12-0XA0



Conectarea terminalelor programabile Easy Harmony ET6 prin Modbus

Descriere	Conexiune seriala Modbus
Compatibilitate	Toate modelele Easy Harmony ET6
Unitati de deconectare	Cutie de divizare Modbus cu 8 porturi LU9GC32-port-tap junction TWDXCAISO si TWDXCAT3RJ
Protocol de comunicare	Modbus
Tipul de conexiune	1 conector tata RJ45/9-pini SUB-D
Interfata	RS 485
Lungimea cablului (m)	2,5
Referinta	XBTZ9008

A man with short, light-colored hair, wearing safety glasses and a dark long-sleeved shirt, is focused on working on a green industrial machine. He is leaning forward, with his hands on the machine. The background shows a factory environment with blue structural elements and various cables. A semi-transparent green banner is overlaid at the bottom of the image, containing the text.

03. Variatoare de viteza Easy Altivar

Easy Altivar 610 - Variatoare IP20 (0,75...160 kW)



Tensiune de alimentare trifazata: 380...460 V 50/60 Hz, cu filtru EMC integrat de categoria C3.

ND: Sarcina normala(2),HD:Sarcina grea(3)			ND	HD	ND	HD	ND	HD	ND	HD	ND	HD
Motor (1)	Puterea inscrisa pe placuta de identificare	kW	0,75	0,37	1,5	0,75	2,2	1,5	3	2,2	4	3
		HP	1	0,5	2	1	3	2	4	3	5	–
Easy Altivar 610	Curent de iesire continuu max. (1)	A	2,2	1,5	4,0	2,2	5,6	4,0	7,2	5,6	9,3	7,2
Dimensiuni: A x l x L (mm)	Placa EMC nu este montata (mm)		145 x 297 x 203 ①									
Referinta			ATV610U07N4		ATV610U15N4		ATV610U22N4		ATV610U30N4		ATV610U40N4	

ND: Sarcina normala(2),HD: Sarcina grea(3)			ND	HD	ND	HD	ND	HD	ND	HD	ND	HD		
Motor (1)	Puterea inscrisa pe placuta de identificare	kW	5,5	4	7,5	5,5	11	7,5	15	11	18,5	15		
		HP	7,5	5	10	7,5	15	10	20	15	25	20		
Easy Altivar 610	Curent de iesire continuu max. (1)	A	12,7	9,3	15,8	12,7	23,5	16,5	31,7	23,5	39,2	31,7		
Dimensiuni: A x l x L (mm)	Placa EMC nu este montata (mm)		145 x 297 x 203 ①				171 x 360 x 233 ②				211 x 495 x 232 ③			
Referinta			ATV610U55N4		ATV610U75N4		ATV610D11N4		ATV610D15N4		ATV610D18N4			

ND: Sarcina normala(2),HD: Sarcina grea (3)			ND	HD	ND	HD	ND	HD	ND	HD	ND	HD		
Motor (1)	Puterea inscrisa pe placuta de identificare	kW	22	18,5	30	22	37	30	45	37	55	45		
		HP	30	25	40	30	50	40	60	50	75	60		
Easy Altivar 610	Curent de iesire continuu max. (1)	A	46,3	39,2	61,5	46,3	74,5	59,6	88	74,5	106	88		
Dimensiuni: A x l x L (mm)	Placa EMC nu este montata (mm)		211 x 495 x 232 ③			226 x 613 x 271 ④			290 x 762 x 323 ⑤					
Referinta			ATV610D22N4		ATV610D30N4		ATV610D37N4		ATV610D45N4		ATV610D55N4			

ND: Sarcina normala(2),HD:Sarcina grea(3)			ND	HD	ND	HD	ND	HD	ND	HD	ND	HD
Motor (1)	Puterea inscrisa pe placuta de identificare	kW	75	55	90	75	110	90	132	110	160	132
		HP	100	75	125	100	149	125	178	149	216	178
Easy Altivar 610	Curent de iesire continuu max. (1)	A	145	106	173	145	211	173	250	211	302	250
Dimensiuni: A x l x L (mm)	Placa EMC nu este montata (mm)		290 x 762 x 323 ⑤				320 x 852 x 390 ⑥					
Referinta			ATV610D75N4		ATV610D90N4		ATV610C11N4		ATV610C13N4		ATV610C16N4	

(1) Aceste valori sunt date pentru o frecventa de comutare nominala de 4 kHz pana la ATV610D45N4 sau de 2,5 kHz pentru ATV610D55N4...C16N4 pentru utilizare in regim de functionare continua. Frecventa de comutare este reglabila de la 2...12 kHz pana la ATV610D45N4, sau de la 1...8 kHz pentru ATV610D55N4...C16N4. Peste 2,5 sau 4 kHz (in functie de valoarea nominala), variatorul va reduce automat frecventa de comutare in cazul unei cresteri excesive a temperaturii. Pentru o functionare continua peste frecventa de comutare nominala, reduceti curentul nominal al variatorului (consultati curbe de declasangere cu temperatura de pe site-ul nostru web).

(2) Valori indicate pentru aplicatii care necesita o usoara suprasarcina (pana la 110 % pentru 60 s sau 120 % pentru 20 s).

(3) Valori indicate pentru aplicatii care necesita o usoara suprasarcina (pana la 150 % timp de 60 s).

(4) Cu un kit de conformitate IP21.

Easy Altivar 610 - Instrumente de configurare si timp de executie, circuite si retele de comunicatii



Terminal de afisare a textului simplu

Gradul de protectie	IP21
Tipul de afisaj	Ecan LCD, alb
Rezolutia pixelului	128 x 64
Referinta	VW3A1113



Kit de montare la distanta

Tipul de produs	Kit de montare la distanta pentru terminalul de afisare 1	Instrument de strangere pentru kitul de montare 2	Set de cabluri de montare la distanta (echipat cu 2 conectori RJ45) 3			
Gradul de protectie	IP20	-	-	-	-	-
Lungime (m)	-	-	1	3	5	10
Tipul de conector	-	-	RJ45			
Referinta	VW3A1114	ZB5AZ905	VW3A1104R10	VW3A1104R30	VW3A1104R50	VW3A1104R100



Module I/O (optiune)

Tip I/O	Intrari digitale	6	-
	Iesiri digitale	2	-
	Intrari analogice	2 (1)	-
	Iesiri cu releu	-	3 (2)
Referinta	VW3A3203	VW3A3204	



Modul de comunicatie optional PROFIBUS DP V1

Conexiune electrica	1 conector mama SUB-D 9
Rata de transmisie	9,6 kbps...12 Mbps
Tipul de afisaj	1 LED pentru RUN, 1 LED pentru defect de retea
Profilul bus-ului	PROFIdrive, CiA 402
Referinta	VW3A3607

(1) Intrari analogice diferentiale configurabile prin software ca intrari de curent (0-20 mA/4-20 mA) sau de sonda (PTC, PT100 sau PT1000 cu 2 sau 3 fire). Atunci cand sunt configurate ca intrari de sonda PTC, acestea nu trebuie sa fie utilizate niciodata pentru a proteja un motor ATEX in aplicatii in atmosfere explozive. Va rugam sa consultati ghidul ATEX de pe site-ul nostru web.
(2) NU exista contacte.

Easy Altivar 610 - Accesorii pentru montarea variatoarelor de viteza



Kit pentru conformitate IP 21

Pentru utilizare cu variatoare de viteza	ATV610C11N4... C16N4
Putere	kW 110...160
	HP 149...216
Referinta	VW3A9704

Easy Altivar 310 - Variatoare IP20 (380...460 V 50/60 Hz)



Tensiune de alimentare trifazata: 380...460 V 50/60 Hz, fara filtru EMC

Motor	0,37 0,5	0,75 1	1,5 2	22 3	3 4
Easy Altivar 310	1,5	2,3	4,1	5,5	7,1
Dimensiuni: A x l x L (mm)	72 x 143 x 130 ①	72 x 143 x 140 ①	105 x 143 x 151 ②		140 x 184 x 151 ③
Referinta	ATV310H037N4E	ATV310H075N4E	ATV310HU15N4E	ATV310HU22N4E	ATV310HU30N4E

Motor	4 5	5,5 7,5	7,5 10	11 15
Easy Altivar 310	9,5	12,6	17	24
Dimensiuni: A x l x L (mm)	140 x 151 x 184 ④	140 x 184 x 151 ③	150 x 232 x 171 ⑤	
Referinta	ATV310HU40N4E	ATV310HU55N4E	ATV310HU75N4E	ATV310HD11N4E

(1) Aceste valori sunt date pentru o frecventa de comutare nominala de 4 kHz, pentru utilizare in regim de functionare continua. Daca functionarea peste 4 kHz trebuie sa fie continua, curentul nominal de comanda trebuie redus cu 10% pentru 8 kHz si cu 20% pentru 12 kHz.



Instrumente de configurare Simple Loader, Multi-Loader si cablu asociat

Descriere	Instrumentul Simple Loader ⑥ Pentru duplicarea configuratiei unui variator pe un alt variator. Variatoarele trebuie sa fie sub tensiune.	Instrumentul Multi-Loader ⑦ Pentru copierea unei configuratii de pe un PC sau de pe un variator si duplicarea acestuia pe un alt variator. Nu este necesar ca variatoarele sa fie alimentate cu energie electrica.	Set de cabluri pentru instrumentul Multi-Loader ⑧ Pentru conectarea dispozitivului Multi-Loader la variatorul Easy Altivar 310 in ambalajul sau.
Compozitia kitului	Instrumentul Simple Loader 1 set de cabluri cu 2 conectori RJ45	Instrumentul Multi-Loader 1 adaptor RJ45 mama/mama 4 baterii AA/LR6 1,5 V 1 set de cabluri cu 2 conectori RJ45 1 card de memorie SD 2 Go 1 set de cabluri cu 1 conector USB tip A si 1 conector USB tip mini B	Echizat cu un conector RJ45 care nu se blocheaza, cu prindere mecanica speciala la capatul de actionare si un conector RJ45 la capatul Multi-Loader.
Pentru utilizare cu	ATV310H●●●N4E	ATV310H●●●N4E	ATV310H●●●N4E
Referenta	VW3A8120	VW3A8121	VW3A8126

Terminalele de afisare la distanta si cablurile aferente

Descriere	Terminale de afisare la distanta ⑨ Pentru fixarea interfeței HMI pe usa unei incinte cu grad de protectie IP 54 sau IP 65. Este necesar, de asemenea, un set de cabluri de fixare la distanta VW3A1104Rp.	Cabluri de fixare la distanta ⑩ Echizat cu 2 conectori RJ45. Pentru conectarea terminalului de afisare la distanta VW3 A1006 sau VW3A1007 la variatorul Easy Altivar 310.
Pentru utilizare cu	ATV310H●●●N4E ATV310H●●●N4E	ATV310H●●●N4E ATV310H●●●N4E
Grad de protectie	IP54 IP65	-
Dimensiuni: A x l x L (mm)	50 x 70 x 22,7 66 x 106 x 26,7	Hossz: 1 m/3,28 ft Hossz: 3 m/9,84 ft
Referinta	VW3A1006 VW3A1007	VW3A1104R10 VW3A1104R30

Easy Altivar 310 - Bobine de linie si bobine de motor



Bobine de linie						
Se utilizeaza cu		ATV310H037N4E	ATV310H075N4E	ATV310HU15N4E	ATV310HU22N4E	ATV310HU30N4E
Curent de linie cu inductor	380 V	1,1	1,9	3,5	5,1	6,6
	460 V	1	1,7	2,9	4,4	5,6
Curent de linie fara inductor	380 V	2,1	3,5	6,5	8,8	11,1
	460 V	1,8	3,1	5,4	7,2	9,2
Dimensiuni: A x l x L (mm)		100 x 135 x 60		130 x 155 x 90		
Referinta		VW3A4551		VW3A4552		
Se utilizeaza cu		ATV310HU40N4E	ATV310HU55N4E	ATV310HU75N4E	ATV310HD11N4E	
Curent de linie cu inductor	380 V	8,5	11,6	15,2	22	
	460 V	7,1	9,9	12,8	18,9	
Curent de linie fara inductor	380 V	13,7	21,3	26,6	36,1	
	460 V	11,4	14,3	22,4	30,4	
Dimensiuni: A x l x L (mm)		130 x 155 x 90		155 x 170 x 135		
Referinta		VW3A4553		VW3A4554		
Bobine de motor						
Se utilizeaza cu		ATV310HU22N4E	ATV310HU55N4E	ATV310HU75N4E		
Pierderi (W)		65	75	90		
Curent nominal (A)		10	16	30		
Dimensiuni: A x l x L (mm)		130 x 155 x 90		155 x 170 x 135		
Referinta		VW3A4552	VW3A4553	VW3A4554		

Easy Altivar 310 - Rezistori de franare

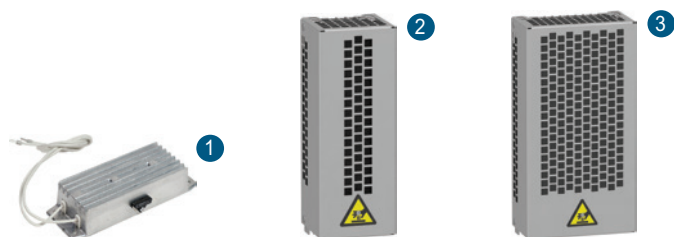

Rezistori de franare				
Rezistor (IP00)				
Se utilizeaza cu	ATV310HU15N4E	ATV310HU22N4E	ATV310HU30N4E	ATV310HU40N4E
Valoarea ohmica minima (Ω)	80	60	36	36
Valoarea ohmica la 20° C (Ω)	100		100	
Putere disponibila la 50° C (kW) (2)	0,028		0,035	
Dimensiuni: A x l x L (mm)	60 x 170 x 30		62 x 212 x 36	
Referinta	VW3A7723 1		VW3A7725 1	
Rezistor (IP20 sau 23)				
Se utilizeaza cu	ATV310HU15N4E	ATV310HU22N4E	ATV310HU30N4E	ATV310HU40N4E
Valoarea ohmica minima (Ω)	80	60	36	36
Valoarea ohmica la 20° C (Ω)	100			
Putere disponibila la 50° C (kW) (2)	0,1			
Dimensiuni: A x l x L (mm)	105 x 295 x 100			
Referinta	VW3A7730 2			
Rezistor (IP20 sau 23)				
Se utilizeaza cu	ATV310HU55N4E	ATV310HU75N4E	ATV310HD11N4E	
Valoarea ohmica minima (Ω)	28	28	28	
Valoarea ohmica la 20° C (Ω)	60		28	
Putere disponibila la 50° C (kW) (2)	0,16		0,3	
Dimensiuni: A x l x L (mm)	105 x 345 x 100		175 x 345 x 100	
Referinta	VW3A7731 2		VW3A7732 3	

(1) Pentru rezistorii IP00, adaugati un dispozitiv de suprasarcina termica.

(2) Factorul de sarcina pentru rezistori: valoarea puterii medii care poate fi disipata la 50 °C din rezistenta in carcasa este determinata pentru un factor de sarcina in timpul franarii care corespunde majoritatii aplicatiilor normale.

Pentru VW3A7730...733:

- 2 s de franare cu un cuplu de franare de 0,6 Tn pentru un ciclu de 40 s

- franare de 0,8 s cu un cuplu de franare de 1,5 Tn pentru un ciclu de 40 s

Easy Altivar 310 - Legatura seriala Modbus



Legatura seriala Modbus

Conectare prin intermediul cutiei de divizare si a conectorilor RJ45

Descriere	Cutie de divizare Modbus 1 10 conectori RJ45 si 1 terminal cu surub	Cabluri pentru legatura seriala Modbus 2 echipat cu 2 conectori RJ45		
Lungime (m)	-	0,3	1	3
Referinta	LU9GC3	VW3A8306R03	VW3A8306R10	VW3A8306R30



Descriere	Cutii de jonctiune T Modbus 3 (cu un cablu integrat)		Terminatori de linie 4 Pentru conectorul RJ45	
Lungime (m)	0,3	1	-	-
Referinta	VW3A8306TF03	VW3A8306TF10	VW3A8306RC	VW3A8306R



ACHTUNG!
Bei unsicherem Zustand
Hilfsmittel oder Sperrmaße
ATTENTION!
Hilfsmittel oder Sperrmaße
ATTENTION!
Hilfsmittel oder Sperrmaße

CIRCUIT IOT

04. Relee electromecanice Easy Harmony

Easy Harmony RXM*LB - Relee miniaturale



Easy Harmony RXM*LB relee miniaturale

Tip	Cu LED - Relee miniaturale fara buton de testare blocabil		
Contact	2 CO		4 CO
Curent termic inchis (Ithe)	5 A		3 A
Probus complet	12 VDC	RXM2LB2JD	RXM4LB2JD
	24 VDC	RXM2LB2BD	RXM4LB2BD
	36 VDC	-	RXM4LB2CD
	48 VDC	RXM2LB2ED	RXM4LB2ED
	110 VDC	RXM2LB2FD	RXM4LB2FD
	24 VAC	RXM2LB2B7	RXM4LB2B7
	120 VAC	RXM2LB2F7	RXM4LB2F7
	230 VAC	RXM2LB2P7	RXM4LB2P7

Tip	Fara LED - Relee miniaturale fara buton de testare blocabil		
Contact	2 CO		4 CO
Curent termic inchis (Ithe)	5 A		3 A
Probus complet	12 VDC	RXM2LB1JD	RXM4LB1JD
	24 VDC	RXM2LB1BD	RXM4LB1BD
	24 VAC	RXM2LB1B7	RXM4LB1B7
	120 VAC	RXM2LB1F7	RXM4LB1F7
	230 VAC	RXM2LB1P7	RXM4LB1P7



Se utilizeaza cu	RXM2	RXM4
Soclu cu clema si surub	RXZE1M2C	RXZE1M4C



Se utilizeaza cu	RXZE1M●C	RXZE1M2C
Clema metalica de mentinere	RXZ410	RXZ420

Nota: daca este necesar un modul de protectie, va rugam sa folositi prize RXZE cu modulul de protectie asociat RXM0. Puteti gasi mai multe detalii in catalogul de relee electromecanice Harmony - sectiunea gama RXM AB.



05. Surse de alimentare Easy Modicon

Easy Modicon ABL2K - Surse de alimentare si accesorii



ABL2 surse de alimentare de 24 V DC in comutatie 1

Modalitate de racire	Convectie naturala			
Resetare automata a protectiei	Da			
Comutare de tensiune	Automat			
Tensiune de intrare monofazata (47~63Hz)	100...240 V AC			
Tensiunea de iesire	24 V DC			
Putere (W)	35		50	
Curent de iesire (A)	1.5		2.2	
Protectie impotriva socurilor de suprasarcina (%)	110-160		170-190	
Referinta	ABL2REM24015K	ABL2REM24020K	ABL2REM24015KQ	ABL2REM24020KQ

Modalitate de racire	Convectie naturala			
Resetare automata a protectiei	Da			
Comutare de tensiune	Automat		Manual	
Tensiune de intrare monofazata (47~63Hz)	100...240 V AC		100...120 V AC, 200...240 V AC	
Tensiunea de iesire	24 V DC			
Putere (W)	100		150	
Curent de iesire (A)	4.5		6.5	
Protectie impotriva socurilor de suprasarcina (%)	110-160		170-190	
Referinta	ABL2REM24045K	ABL2REM24065K	ABL2REM24045KQ	ABL2REM24065KQ

Modalitate de racire	Convectie naturala	Racire forzata a aerului prin ventilator DC incorporat	
Resetare automata a protectiei	Da		
Comutare de tensiune	Manual		
Tensiune de intrare monofazata (47~63Hz)	100...120 V AC, 200...240 V AC		
Tensiunea de iesire	24 VDC		
Putere (W)	200	250	350
Curent de iesire (A)	8.3	10.5	14.6
Protectie impotriva socurilor de suprasarcina (%)	110-150		
Referinta	ABL2REM24085K	ABL2REM24100K	ABL2REM24150K



Optiuni pentru sursele de alimentare ABL2

Tipul de accesoriu de montare	Suport cu 4 colturi 2	Placa de montare cu clips 3	Accesorii de tip L 4	
Descriere	Pentru montare directa pe panoul din spate. Suruburile de montare nu sunt furnizate. Utilizare recomandata: Suruburi M4 (6 mm/0,24 in) sau M4 (8 mm/0,31 in).	Pentru montare pe sina DIN de 35 mm (1,37 in.)	Dimensiune: Mic L	Dimensiune: Mare L
Pentru sursele de alimentare	ABL2REM24085K, ABL2REM24100K, ABL2REM24150K	Toate modelele	ABL2REM24015K, ABL2REM24020K, ABL2REM24045K, ABL2REM24065K	ABL2REM24085K, ABL2REM24100K, ABL2REM24150K
Referinta	ABL2K01	ABL2K02	ABL2K03A	ABL2K03B



06. Intreruptoare EasyPact
de la 100 la 3200 A

EasyPact CVS 100/160/250 - Intreruptoare in carcasa turnata



EasyPact CVS 100/160/250B, 25 kA 380/415 V -TM-D cu unitate de declansare magneto-termica

EasyPact CVS100B (25 kA 380/415 V)			
Clasificare	3P 3d	4P 3d	4P 4d
TM16D	LV510300	LV510311	-
TM25D	LV510301	LV510341	LV510321
TM32D	LV510302	LV510312	LV510322
TM40D	LV510303	LV510313	LV510323
TM50D	LV510304	LV510314	LV510324
TM63D	LV510305	LV510315	LV510325
TM80D	LV510306	LV510316	LV510326
TM100D	LV510307	LV510317	LV510327

EasyPact CVS160B (25 kA la 380/415 V)			
Clasificare	3P 3d	4P 3d	4P 4d
TM100D	LV516301	LV516311	-
TM125D	LV516302	LV516312	LV516322
TM160D	LV516303	LV516313	LV516323

EasyPact CVS250B (25 kA la 380/415 V)			
Clasificare	3P 3d	4P 3d	4P 4d
TM160D	LV525301	-	-
TM200D	-	LV525312	LV525322
TM250D	-	LV525313	LV525323

EasyPact CVS 100/160/250F, 36 kA 380/415 V -TM-D cu unitate de declansare magneto-termica

EasyPact CVS100F (36 kA 380/415 V)			
Clasificare	3P 3d	4P 3d	4P 4d
TM16D	LV510330	LV510340	-
TM25D	LV510331	LV510341	-
TM32D	LV510332	LV510342	LV510352
TM40D	LV510333	LV510343	LV510353
TM50D	LV510334	LV510344	LV510354
TM63D	LV510335	LV510345	LV510355
TM80D	LV510336	LV510346	LV510356
TM100D	LV510337	LV510347	LV510357

EasyPact CVS160F (36 kA 380/415 V)			
Clasificare	3P 3d	4P 3d	4P 4d
TM100D	LV516331	LV516341	-
TM125D	LV516332	LV516342	LV516352
TM160D	LV516333	LV516343	LV516353

EasyPact CVS250F (36 kA 380/415 V)			
Clasificare	3P 3d	4P 3d	4P 4d
TM160D	LV525331	-	-
TM200D	LV525332	LV525342	LV525352
TM250D	LV525333	LV525343	LV525353

EasyPact CVS 100/160/250N, 50 kA 380/415 V -TM-D cu unitate de declansare magneto-termica

EasyPact CVS100N (50 kA 380/415 V)			
Clasificare	3P 3d	4P 3d	
TM16D	LV510470	LV510480	
TM25D	LV510471	LV510481	
TM32D	LV510472	LV510482	
TM40D	LV510473	LV510483	
TM50D	LV510474	LV510484	
TM63D	LV510475	LV510485	
TM80D	LV510476	LV510486	
TM100D	LV510477	LV510487	

EasyPact CVS160N (50 kA 380/415 V)			
Clasificare	3P 3d	4P 3d	
TM100D	LV516461	LV516466	
TM125D	LV516462	LV516467	
TM160D	LV516463	LV516468	

EasyPact CVS250N (50 kA 380/415 V)			
Clasificare	3P 3d	4P 3d	
TM200D	LV525452	LV525457	
TM250D	LV525453	LV525458	

EasyPact CVS 100/160/250 - Intreruptoare in carcasa turnata

EasyPact CVS 100/160/250F, 36kA - ETS 2.2 cu declansator electronic (LS0I)		
EasyPact CVS100F (36 kA 380/415 V)		
Clasificare	3P 3d	4P 3d, 4d, 3d + N/2
40	LV510552	LV510582
100	LV510553	LV510583
EasyPact CVS160F (36 kA 380/415 V)		
Clasificare	3P 3d	4P 3d, 4d, 3d + N/2
160	LV516506	LV516509
EasyPact CVS250F (36 kA 380/415 V)		
Clasificare	3P 3d	4P 3d, 4d, 3d + N/2
250	LV525506	LV525509
EasyPact CVS 100/160/250N, 50 kA 380/415 V - ETS 2.2 cu declansator electronic (LS0I)		
EasyPact CVS100N (50 kA 380/415 V)		
Clasificare	3P 3d	4P 3d, 4d, 3d + N/2
40	LV510554	LV510555
100	LV510584	LV510585
EasyPact CVS160N (50 kA 380/415 V)		
Clasificare	3P 3d	4P 3d, 4d, 3d + N/2
160	LV516507	LV516510
EasyPact CVS250N (50 kA 380/415 V)		
Clasificare	3P 3d	4P 3d, 4d, 3d + N/2
250	LV525507	LV525510
EasyPact CVS 100/160/250 NA - separator de sarcina		
EasyPact CVS100 NA		
Clasificare	3P	4P
100	LV510425	LV510426
EasyPact CVS160 NA		
Clasificare	3P	4P
160	LV516425	LV516426
EasyPact CVS250 NA		
Clasificare	3P	4P
250	LV525425	LV525426
EasyPact CVS 100/160/250F, 36 kA 380/415 V - MA cu unitate de declansare magnetica		
EasyPact CVS100F (36 kA 380/415 V)		
Clasificare	3P 3d	
MA2,5	LV510430	
MA6,3	LV510431	
MA12,5	LV510432	
MA25	LV510433	
MA50	LV510434	
MA100	LV510435	
EasyPact CVS160F (36 kA 380/415 V)		
Clasificare	3P 3d	
MA100	LV516439	
MA150	LV516440	
EasyPact CVS250F (36 kA 380/415 V)		
Clasificare	3P 3d	
MA220	LV525439	
EasyPact CVS 100/160/250N, 50 kA 380/415 V - MA cu unitate de declansare magnetica		
EasyPact CVS100N (50 kA 380/415 V)		
Clasificare	3P 3d	
MA2,5	LV510450	
MA6,3	LV510451	
MA12,5	LV510452	
MA25	LV510453	
MA50	LV510454	
MA100	LV510455	
EasyPact CVS160N (50 kA 380/415 V)		
Clasificare	3P 3d	
MA100	LV516450	
MA150	LV516451	
EasyPact CVS250N (50 kA 380/415 V)		
Clasificare	3P 3d	
MA220	LV525442	

EasyPact CVS 100/160/250 - Intreruptoare in carcasa turnata

EasyPact CVS 160/250B, - TM-G cu unitate de declansare magneto-termica

EasyPact CVS160B (25 kA la 380/415 V)

Clasificare	3P 3d	4P 3d
TM80G	LV510736	LV510748
TM100G	LV510737	LV510749
TM125G	LV516732	LV516742
TM160G	LV516733	LV516743

EasyPact CVS250B (25 kA la 380/415 V)

Clasificare	3P 3d	4P 3d
TM200G	LV525732	LV525733
TM250G	LV525742	LV525743

EasyPact CVS 100/160/250 - Accesorii



Accesorii de conectare din cupru sau aluminiu

Descriere	Conectori pentru cabluri goale, otel 1		Conectori din aluminiu 2				Conectori din aluminiu pentru 2 cabluri (1) 3	
	1 x (1,5-95 mm ²); ≤ 160 A		1 x (25-95 mm ²); ≤ 250 A		1 x (120-185 mm ²); ≤ 250 A		2 x (50-120 mm ²); ≤ 250 A	
	Set de 3	Set de 4	Set de 3	Set de 4	Set de 3	Set de 4	Set de 3	4 Set de 4
Referinta	LV429242	LV429243	LV429227	LV429228	LV429259	LV429259	LV429218	LV429219



Descriere	Piesa marire pas polar Pas de 45 mm(1) 4		Papuci pentru cabluri din cupru (1) 5					
	-		Pentru cablu de 120 mm ²		Pentru cablu de 150 mm ²		Pentru cablu de 185 mm ²	
	Set de 3	Set de 4	Set de 3	Set de 4	Set de 3	Set de 4	Set de 3	Set de 4
Referinta	LV431563	LV431564	LV429252	LV429256	LV429253	LV429257	LV429254	LV429258



Descriere	Papuci pentru cablu din aluminiu (1) 6			
	Pentru cablu de 150 mm ²		Pentru cablu de 185 mm ²	
	Set de 3	Set de 4	Set de 3	Set de 4
Referinta	LV429504	LV429505	LV429506	LV429507



Descriere	Accesorii de izolare							
	1 capac scurt pentru bornele intrruptorului 7		1 capac lung pentru intrruptor 8		Bariere intre faze 9		2 ecrane spate (pas 45 mm) 10	
	3 P	4 P	3 P	4 P	Set de 6	3 P	4 P	
Referinta	LV429515	LV429516	LV429517	LV429518	LV429329	LV429330	LV429331	



Manete rotative

Descriere	Maneta rotativa directa - cu maner negru 11				Maneta rotativa extinsa - cu maner negru 12			
Referinta	LV429337				LV429338			

(1) Echipat cu separatoare de 2 sau 3 faze.

Telecomanda

Descriere	110-230V AC/DC 50/60Hz				400V AC 50/60Hz			
Referinta	LV435001				LV435002			

Protectie diferentiala - Vigi

Descriere	CVS100/160 Vigi 200-440V 3P		CVS100/160 Vigi 200-440V 4P		CVS250 Vigi 200-440V 3P		CVS250 Vigi 200-440V 4P	
Referinta	LV529488		LV529489		LV529492		LV529493	

Contacte auxiliare si bobine de declansare

Descriere	Contact auxiliar OF,SD,SDE 6 A-240 V	Adaptor SDE	MX bobina de declansare 110-130V AC	MX bobina de declansare 220-240V AC	MX bobina de declansare 24V DC	MN bobina de declansare 110-130V AC	MN bobina de declansare 220-240V AC	MN bobina de declansare 24V DC
Referinta	29450	LV429451	LV429386	LV429387	LV429390	LV429406	LV429407	LV429410

EasyPact CVS 400/630 - Intreruptoare in carcasa turnata



EasyPact CVS400/630F 36 kA 380/415 V - TM-D cu unitate de declansare magneto-termica			
EasyPact CVS400F (36 kA 380/415 V)			
Clasificare	3P 3d	4P 3d	4P 4d
TM320D	LV540305	LV540308	LV540311
TM400D	LV540306	LV540309	LV540312
EasyPact CVS630F (36 kA 380/415 V)			
Clasificare	3P 3d	4P 3d	4P 4d
TM500D	LV563305	LV563308	LV563311
TM630D	LV563306	LV563309	LV563312
EasyPact CVS 400/630N, 50 kA 380/415 V -TM-D cu unitate de declansare magneto-termica			
EasyPact CVS400N (50 kA 380/415 V)			
Clasificare	3P 3d	4P 3d	4P 4d
TM320D	LV540315	LV540318	-
TM400D	LV540316	LV540319	LV540322
EasyPact CVS630N (50 kA 380/415 V)			
Clasificare	3P 3d	4P 3d	4P 4d
TM500D	LV563315	LV563318	LV563321
TM630D	LV563316	LV563319	LV563322
EasyPact CVS 400/630H, 70 kA 380/415 V -TM-D cu unitate de declansare magneto-termica			
EasyPact CVS400H (70 kA 380/415 V)			
Clasificare	3P 3d	4P 3d	
TM320D	LV540325	LV540328	
TM400D	LV540326	LV540329	
EasyPact CVS630H (70 kA 380/415 V)			
Clasificare	3P 3d	4P 3d	
TM500D	LV563325	LV563326	
TM630D	LV563328	LV563329	
EasyPact CVS 400/630 F/N/H - MA cu unitate de declansare magnetica			
EasyPact CVS400F (36 kA 380/415 V)			
Clasificare	3P 3d		
MA320	LV540550		
EasyPact CVS400N (50 kA 380/415 V)			
Clasificare	3P 3d		
MA320	LV540552		
EasyPact CVS400H (50 kA 380/415 V)			
Clasificare	3P 3d		
MA320	LV540554		
EasyPact CVS630F (36 kA 380/415 V)			
Clasificare	3P 3d		
MA500	LV563550		
EasyPact CVS630N (50 kA 380/415 V)			
Clasificare	3P 3d		
MA500	LV563552		
EasyPact CVS630H (50 kA 380/415 V)			
Clasificare	3P 3d		
MA500	LV563554		
EasyPact CVS 400/630 NA - separator de sarcina			
EasyPact CVS400 NA			
Clasificare	3P	4P	
	LV540400	LV540401	
EasyPact CVS630 NA			
Clasificare	3P	4P	
	LV563400	LV563401	

EasyPact CVS 400/630 - Accesorii



Accesorii de conectare (Cu sau Al)

Descriere	Conectori din aluminiu 3		Conectori din aluminiu 4		Conector pentru masura de tensiune pentru 1 sau 2 cabluri de conectare din aluminiu 5			
	1x (35-300 mm ²)		2x (35-240 mm ²)		-			
	Set de 3	Set de 4 piese	Set de 3	Set de 4 piese	Set de 10 piese			
Referinta	LV432479	LV432480	LV432481	LV432482	LV429348			



Descriere	Piesa marire pas polar 6				Papuci pentru cablu de cupru ((1) 7			
	52,5 mm		70 mm		Pentru cablu de 240 mm ²		Pentru cablu de 300 mm ²	
	3P	4P	3P	4P	Set de 3	Set de 4 piese	Set de 3	Set de 4 piese
Referinta	LV432490	LV432491	LV432492	LV432493	LV432500	LV432501	LV432502	LV432503

Descriere	Papuci pentru cablu de aluminiu (1) 8			
	Pentru cablu de 240 mm ²		Pentru cablu de 240 mm ²	
	Set de 3	Set de 4 piese	Set de 3	Set de 4 piese
Referinta	LV432504	LV432505	LV432506	LV432507



Descriere	Accesorii de izolare								
	Capac borne scurt, 45 mm 9		Capac borne lung, 45 m (1 bucata) 10		Bariere intre faze 11	Capac borne lung pentru bornele cu papuci 12		Capac izolator spate 13	
	3 P	4 P	3 P	4 P	Set de 6 piese	3 P	4 P	3 P	4 P
Referinta	LV432591	LV432592	LV432593	LV432594	LV432570	LV432595	LV432596	LV432578	LV432579



Manete rotative

Descriere	Maneta rotativa directa - cu maner negru standard 14	Maneta rotativa extinsa standard 15
	Referinta	LV432597

(1) Echipat cu separatoare de 2 sau 3 faze.



Telecomanda

Descriere	110-230V AC/DC 50/60Hz	400V AC 50/60Hz
Referinta	LV435010	LV435005

Protectie diferentiala - Vigi

Descriere	CVS400/630 Vigi 200-440V 3P	CVS400/630 Vigi 200-440V 4P
Referinta	LV532464	LV532465

Contacte auxiliare si bobine de declansare

Descriere	Contact auxiliar OF,SD,SDE 6 A-240 V	Convertor SDE	MX bobina de declansare 110-130V AC	MX bobina de declansare 220-240V AC	MX bobina de declansare 24V DC	MN bobina de declansare 110-130V AC	MN bobina de declansare 220-240V AC	MN bobina de declansare 24V DC
	Referinta	29450	LV540050	LV429386	LV429387	LV429390	LV429406	LV429407

EasyPact MVS - Intreruptoare cu rupere in aer

Disponibile in doua dimensiuni

- > 100% produs de calitate Schneider Electric
- > Fiabilitate si siguranta superioara
- > Acopera 90% din nevoile dumneavoastra
- > Gama larga de accesorii

C 50kA					
	630A	800A	1000A	1250A	1600A

H 65kA							
N 50kA							
	800A	1000A	1250A	1600A	2000A	2500A	3200A

Icu (kA eff) 415 V AC tensiune

2 marimi



MVS 1: 630 - 1600A



MVS 2: 800 - 3200A

Pentru a selecta si configura produsul dumneavoastra, utilizati selectorul de produse MVS pe care il puteti accesa pe www.se.com/ro.

Informatii privind unitatile de declansare ET

Fiabilitate

Funcțiile de protecție sunt integrate într-un controler de tip ASIC care garantează un nivel ridicat de siguranță și fiabilitate la perturbări electromagnetice.

Funcțiile de măsurare ale protecțiilor ET sunt controlate de un microprocesor care este complet separat de funcțiile de protecție, asigurând o siguranță maximă.



Interpretarea codului

Tipul de protecție

- 2I Protecție de bază
- Protecție selectivă 5S
- 6G selectiv + protecție la pământ

Tipul de măsurare

- ET de bază
- Măsurarea curentului ETA
- ETV contorizarea energiei electrice și energetice

ET2I: protecție de bază

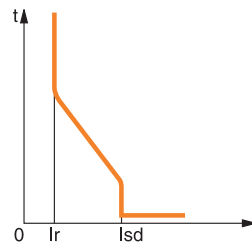

Protecție:
- pe termen lung (supracurent)
- moment

ET5S: protecție selectivă

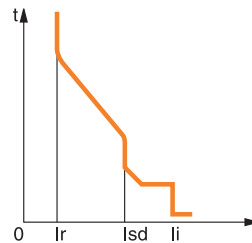





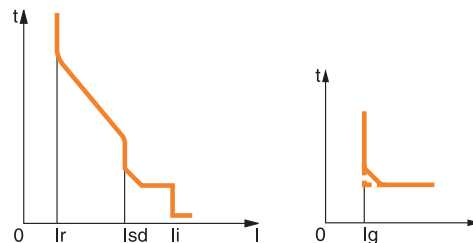



Protecție:
- pe termen lung (supracurent)
- scurt timp (scurtcircuit)
- moment

ET6G: selectiv + protecție la pământ



Protecție:
- pe termen lung (supracurent)
- scurt timp (scurtcircuit)
- moment
- punere la pământ

Informatii privind unitatile de declansare ET

Funcții de protecție și măsură		
ET	ETA	ETV
<ul style="list-style-type: none"> ■ Indicație de eroare ■ Setări de curent și ora (A și sec) 	<ul style="list-style-type: none"> ■ $I_1, I_2, I_3, I_N, I_{\text{defect de punere la pământ}}$ ■ Indicație de eroare ■ Setări de curent și ora (A și sec) 	<ul style="list-style-type: none"> ■ Toate funcțiile unității de declansare ETA: <ul style="list-style-type: none"> □ Tensiune, factor de putere, putere □ Cererea de energie electrică calculată □ Funcția "Vizualizare rapidă" afișarea ciclică a datelor în mod automat
2I	2I	2I
		
5S	5S	5S
		
6G	6G	6G
		

Conexiuni

Conexiune spate

Orizontala

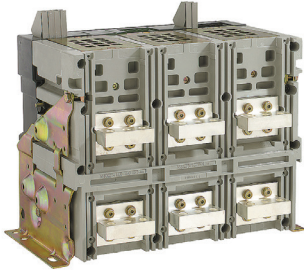

Verticala

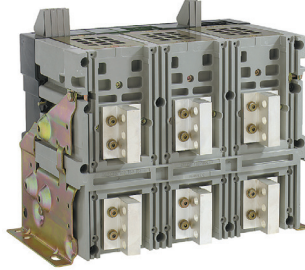

Mixta

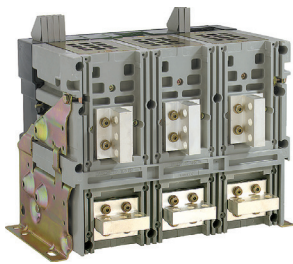

Conexiune frontala

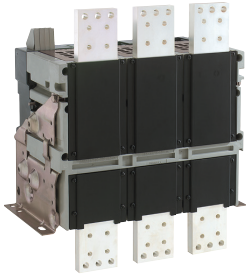

Prin utilizarea unei conexiuni laterale, puterea nominala de rupere a intreruptoarelor este redusa.

EasyPact TVS - Contactoare cu 3 poli (6...6300 A)



Contactoare EasyPact TVS cu 3 poli										
Dimensiune	1 1					2 2		3 3		
Curentul nominal AC-3 (A) (1)	6	9	12	18	25	32	38	40	50	65
Curentul nominal AC-1 (A) (2)	20	25		32	36	50		60	70	80
Puterea nominala AC-3 (kW)	220/230 V	1,1	2,2	3	4	5,5	7,5	9	11	15
	380/400 V	2,2	4	5,5	7,5	11	15	18,5	18,5	22
	415/440 V	2,2	4	5,5	9	11	15	18,5	22	25/30
	500 V	3	5,5	7,5	10	15	18,5	18,5	22	30
660/690 V	3	5,5	7,5	10	15	18,5	18,5	30	33	37
Latime (mm)	45					45,5	56		75	
Tensiunea nominala a bobinei	24...440 V AC in functie de codul de tensiune al bobinei									
Contact auxiliar incorporat	1 NO sau 1 NC							1 NO + 1 NC		
Accesorii compatibile	LAEN-bloc de contacte auxiliare, contact auxiliar intarziat LAETSD (de la un contactor de 25A) LAERC-filtru armonic cu comutator RC (pana la 95 A), LAEMP interblocaj mecanic LAEP-kit de conectare la retea (pana la 95 A)									
Referinta(3)	LC1E06	LC1E09	LC1E12	LC1E18	LC1E25	LC1E32	LC1E38	LC1E40	LC1E50	LC1E65



Dimensiune	4 4		5 5		6 7		7 7		8 7		9 8
Curentul nominal AC-3 (A) (1)	80	95	120	160	200	250	300	400	500	630	
Curentul nominal AC-1 (A) (2)	110	120	150	200	250	300	320	500	700	1000	
Puterea nominala AC-3 (kW)	220/230 V	22	25	37	45	55	75	90	110	147	185
	380/400 V	37	45	55	75	90	132	160	200	250	335
	415/440 V	45	45	59	80	100	140	160/185	220/250	280/295	375/400
	500 V	45	55	75	90	110	160	200	257	355	400
660/690 V	45	45	80	100	110	160	220	280	335	450	
Latime (mm)	85		120		168,5		213		233		309
Tensiunea nominala a bobinei	24...440 V AC in functie de codul tensiunii bobinei (a se vedea tabelul de mai jos)										
Contact auxiliar incorporat	1 NO + 1 NC					-					
Accesorii compatibile	LAEN-bloc de contacte auxiliare, contact auxiliar intarziat LAETSD (de la un contactor de 25A) LAERC-filtru armonic cu comutator RC (pana la 95 A), LAEMP interblocaj mecanic LAEP-kit de conectare la retea (pana la 95 A)										
Referinta (3)	LC1E80	LC1E95	LC1E120	LC1E160	LC1E200	LC1E250	LC1E300	LC1E400	LC1E500	LC1E360	

(1) Clasa AC-3: motoare.

(2) Clasa AC-1: sarcina de curent alternativ cu un cos minim de 0,95 (sarcina rezistiva, incalzire, distributie etc.).

(3) Pentru a selecta un numar de comanda complet, adaugati unul dintre codurile de tensiune a bobinei din tabelul de mai jos la codurile LC1Exx de mai sus. De exemplu: pentru un contactor cu 80 A si o tensiune a bobinei de 220 VAC 50 Hz: LC1E80M5"

Codul tensiunii bobinei disponibile pentru contactoarele cu 3 poli										
		24	48	110	220	230	240	380	415	440
LC1E06-300	50 Hz	B5	E5	F5	M5	-	U5	Q5	N5	R5
	60 Hz	B6	-	F6	M6	-	-	Q6	-	R6
LC1E06-95	50/60Hz	B7	E7	F7	M7	P7	-	Q7	-	-
LC1E400-630	50/60Hz	-	E7	F7	M7	-	U7	Q7	N7	-

EasyPact TVS - Relee de suprasarcina



Relee de suprasarcina EasyPact TVS

Referinta	Calibrare							
		LC1E06	LC1E09	LC1E12	LC1E18	LC1E25	LC1E32	LC1E38
LRE01	0.10...0.16 A	■	■	■	■	■	■	■
LRE02	0.16...0.25 A	■	■	■	■	■	■	■
LRE03	0.25...0.40 A	■	■	■	■	■	■	■
LRE04	0.40...0.63 A	■	■	■	■	■	■	■
LRE05	0.63...1 A	■	■	■	■	■	■	■
LRE06	1...1.6 A	■	■	■	■	■	■	■
LRE07	1.6...2.5 A	■	■	■	■	■	■	■
LRE08	2.5...4 A	■	■	■	■	■	■	■
LRE10	4...6 A	■	■	■	■	■	■	■
LRE12	5.5...8 A		■	■	■	■	■	■
LRE14	7...10 A		■	■	■	■	■	■
LRE16	9...13 A			■	■	■	■	■
LRE21	12...18 A				■	■	■	■
LRE22	16...24 A					■	■	■
LRE32	23...32 A					■	■	■
LRE35	30...38 A							■



Relee de suprasarcina EasyPact TVS

Referinta	Calibrare					
		LC1E40	LC1E50	LC1E65	LC1E80	LC1E95
LRE322	17...25 A	■	■	■	■	■
LRE353	23...32 A	■	■	■	■	■
LRE355	30...40 A	■	■	■	■	■
LRE357	37...50 A		■	■	■	■
LRE359	48...65 A			■	■	■
LRE361	55...70 A				■	■
LRE363	63...80 A				■	■
LRE365	80...104 A					■



Relee de suprasarcina EasyPact TVS

Referinta	Calibrare								
		LC1E120	LC1E160	LC1E200	LC1E250	LC1E300	LC1E400	LC1E500	LC1E630
LRE480	51...81A	■	■	□	□	□	□	□	□
LRE481	62...99A	■	■	□	□	□	□	□	□
LRE482	84...135A	■	■	□	□	□	□	□	□
LRE483	124...198A		□	■	□	□	□	□	□
LRE484	146...234A			□	■	■	■	□	□
LRE485	174...279A			□	■	■	■	□	□
LRE486	208...333A				■	■	■	□	□
LRE487	259...414A					■	■	□	□
LRE488	321...513A						□	■	□
LRE489	394...630A							□	■

Comentarii:

- Releul corespunde contactorului atat din punct de vedere electric, cat si mecanic.
- Releul poate fi conectat la contactor numai prin cablare (nu poate fi montat direct).

EasyPact GZ1E - Intreruptoare magneto-termice de protectie a motoarelor



Intreruptoare de protectie a motoarelor - Comanda cu buton

Valori normale de performanta	230 V	kW	–	–	–	–	–	–	0,37	0,75	1,1
400 V	kW	–	–	–	–	–	–	0,37	0,75	1,5	2,2
Trifazat	440 V	kW	–	–	–	–	–	0,55	1,1	1,5	3
Motoare 50/60 Hz	500 V	kW	–	–	–	–	0,37	0,75	1,1	2,2	3,7
In categoria AC-3	690 V	kW	–	–	–	0,37	0,55	1,1	1,5	3	4
Domeniu de reglare a protectiei termice (A)			0.1...0.16	0.16...0.25	0.25...0.40	0.40...0.63	0.63...1	1...1.6	1.6...2.5	2.5...4	4...6.3
Curent de declansare magnetica $I_d \pm 20\%$ (A)			1,5	2,4	5	8	13	22,5	33,5	51	78
Referinta			GZ1E01	GZ1E02	GZ1E03	GZ1E04	GZ1E05	GZ1E06	GZ1E07	GZ1E08	GZ1E10

Valori normale de performanta	230 V	kW	2,2	–	4	5,5	5,5	7,5
400 V	kW	4	5,5	7,5	9	11	15	
Trifazat	440 V	kW	4	5,5	9	11	15	
Motoare 50/60 Hz	500 V	kW	5,5	9	10	11	15	18,5
In categoria AC-3	690 V	kW	7,5	11	15	18,5	22	22
Domeniu de reglare a protectiei termice (A)			6...10	9...14	13...18	17...23	20...25	24...32
Curent de declansare magnetica $I_d \pm 20\%$ (A)			138	170	223	327	327	416
Referinta			GZ1E14	GZ1E16	GZ1E20	GZ1E21	GZ1E22	GZ1E32

EasyPact TVS - Accesorii



Accesorii cu 3 poli pentru contactorul LC1E

Interblocare mecanica pentru doua contactoare identice	LC1E06...E12	LC1E18/E25	LC1E32/E38	LC1E40...E65	LC1E80/E95	LC1E120/E160	LC1E200/E250	LC1E300	LC1E400	LC1E500	LC1E630
Referinta	LAEP1	LAEP12	LAEP2	LAEP3	LAEP4						
Kit de conectare la retea	1										
Interblocare mecanica	2	LAEM1	LAEM1	LAEM1	LAEM1	LAEM4	LAEM5	LAEM6	LAEM7	LAEM7	LAEM8



3 Descarcator de supratensiune RC

Ansamblu	Racord cu surub				
Pentru utilizare cu un contactor	Clasificare	LC1E06...E95			
	Tip	24...48 V~	50...127 V~	110...240 V~	380...415 V~
Referinta	LAERCE		LAERCG	LAERCU	LAERCN

■ Protectie eficienta pentru circuitele sensibile la interferentele de "inalta frecventa" si la tranzitul generat atunci cand infasurarea contactorului este oprita. Acesta poate fi utilizat numai in cazurile in care tensiunea este practic sinusoidală, adica mai puțin de 5% distorsiune armonica totala.

■ Tensiunea este de max. 3 Uc. si frecventa de vibratie este de max. 400 Hz.

■ Crestere usoara a timpului de eliberare (de 1,2-2 ori mai mult decat in mod normal).

EasyPact TVS - Accesorii



Blocuri de contacte auxiliare temporare cu suruburi (Pentru utilizare într-un mediu de operare normal)

Racord cu clips				
Numarul de contacte pe bloc	1 NO / 1 NC	2 NO	2 NC	2 NO / 2 NC
Referinta ①	LAEN11	LAEN20	LAEN02	LAEN22

Blocuri de contacte auxiliare temporizate 8 A - 690 V

Racord cu clips		
Numarul de contacte pe bloc	1 NO / 1 NC	
Tipul de temporizare	Retragerea intarziata	
Interval de setare	1...30 s	
Referinta ②	LAETSD (numai pentru LC1E25 - LC1E630)	



08. Controlere logice Easy Modicon

Easy Modicon M100 - Controlere logice

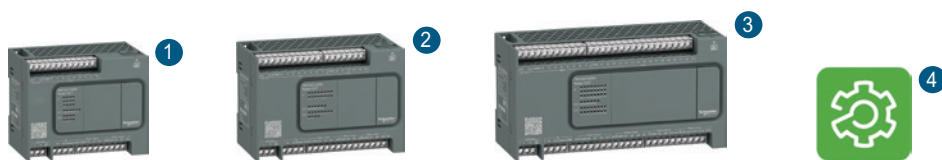

Controlere logice Easy Modicon M100 (1)

Numarul de I/O digitale	16 ¹	24 ²	32 ³	40 ³
Intrari digitale	<ul style="list-style-type: none"> ■ 9 sink/sursa ■ tensiune de intrare 24 VDC ■ 4 intrari rapide FC ■ 3 intrari standard ■ 2 intrari de mare viteza HSC 	<ul style="list-style-type: none"> ■ 14 sink/sursa ■ tensiune de intrare 24 VDC ■ 4 intrari rapide FC ■ 8 intrari standard ■ 2 intrari de mare viteza HSC 	<ul style="list-style-type: none"> ■ 20 sink/sursa ■ tensiune de intrare 24 VDC ■ 4 intrari rapide FC ■ 14 intrari standard ■ 2 intrari de mare viteza HSC 	<ul style="list-style-type: none"> ■ 24 sink/ sursa ■ tensiune de intrare 24 VDC ■ 4 intrari rapide FC ■ 18 intrari standard ■ 2 intrari de mare viteza HSC
Iesiri digitale (iesiri de releu)	7	10	12	16
<i>Legatura seriala (2)</i>	1			
Tensiunea de alimentare	110...220 VAC			
<i>Software de programare (3)</i>	EcoStruxure Machine Expert - Basic ⁴			
Referinta	TM100C16RN	TM100C24RN	TM100C32RN	TM100C40RN

(1) Controlerele M100 sunt furnizate cu:

- blocuri terminale cu suruburi fixe pentru conectarea I/O
- un bloc de borne cu suruburi fixe pentru conectarea sursei de alimentare
- un bloc de borne cu suruburi fixe pentru legatura seriala

(2) Fiecare controler logic M100 are un port de programare USB mini-B incorporat.

(3) PC-ul trebuie sa fie echipat cu Windows 7 sau 10 (32 sau 64 de biti). Pentru a descarca acest software, va rugam sa vizitati site-ul se.com/ro

Easy Modicon M200 - Controlere logice



Controlere logice Easy Modicon M200 (1)

Tensiune de alimentare	110...220 VAC		
Numarul de I/O digitale	16	24	32
Intrari digitale	<ul style="list-style-type: none"> ■ 9 sink/sursa ■ tensiune de intrare 24 VDC ■ 4 intrari rapide FC ■ 1 intrari standard ■ 4 intrari de mare viteza pentru HSC 	<ul style="list-style-type: none"> ■ 14 sink/sursa ■ tensiune de intrare 24 VDC ■ 4 intrari rapide FC ■ 6 intrari standard ■ 4 intrari de mare viteza HSC 	<ul style="list-style-type: none"> ■ 20 sink/sursa ■ tensiune de intrare 24 VDC ■ 4 intrari rapide FC ■ 12 intrari standard ■ 4 intrari de mare viteza HSC
Iesiri digitale (iesiri de releu)	7	10	12
Dimensiuni (A x l x L)	110 x 70 x 90 ¹	130 x 70 x 90 ²	175 x 70 x 90 ³
Ethernet (RJ 45)	–		1
Legatura seriala (2)	1		–
Referinta	TM200C16R	TM200C24R	TM200CE24R

Tensiune de alimentare	110...220 VAC		
Numarul de I/O digitale	32	40	60
Intrari digitale	<ul style="list-style-type: none"> ■ 20 sink/sursa ■ tensiune de intrare 24 VDC ■ 4 intrari rapide FC ■ 12 intrari standard ■ 4 intrari de mare viteza HSC 	<ul style="list-style-type: none"> ■ 24 sink/sursa ■ tensiune de intrare 24 VDC ■ 4 intrari rapide FC ■ 16 intrari standard ■ 4 intrari de mare viteza HSC 	<ul style="list-style-type: none"> ■ 36 sink/sursa ■ tensiune de intrare 24 VDC ■ 4 intrari rapide FC ■ 28 intrari standard ■ 4 intrari de mare viteza HSC
Iesiri digitale (iesiri de releu)	12	16	24
Dimensiuni (Ax l x L)	175 x 70 x 90 ³		225 x 70 x 90 ⁴
Ethernet (RJ 45)	1	–	1
Legatura seriala (2)	1		–
Referinta	TM200CE32R	TM200C40R	TM200CE40R

Tensiune de alimentare	24 VDC		
Numarul de I/O digitale	16		
Intrari digitale	<ul style="list-style-type: none"> ■ 9 sink/sursa ■ tensiune de intrare 24 VDC 	<ul style="list-style-type: none"> ■ 4 intrari rapide FC ■ 1 intrare regulata 	<ul style="list-style-type: none"> ■ 4 intrari de mare viteza HSC
Iesiri digitale	<ul style="list-style-type: none"> ■ 7 iesiri de coborare ■ 5 iesiri normale cu tranzistor ■ 2 iesiri rapide (PWM/PLS/PTO) 		<ul style="list-style-type: none"> ■ 7 iesiri sursa ■ 5 iesiri normale cu tranzistor ■ 2 iesiri rapide (PWM/PLS/PTO)
Dimensiuni (A x l x L)	110 x 70 x 90 ¹		
Ethernet (RJ 45)	–		
Legatura seriala (2)	1		
Referinta	TM200C16T		

Tensiune de alimentare	24 VDC		
Numarul de I/O digitale	24		
Intrari digitale	<ul style="list-style-type: none"> ■ 14 sink/sursa ■ tensiune de intrare 24 VDC 	<ul style="list-style-type: none"> ■ 4 intrari rapide FC ■ 6 intrari standard 	<ul style="list-style-type: none"> ■ 4 intrari de mare viteza HSC
Iesiri digitale	<ul style="list-style-type: none"> ■ 10 iesiri de coborare ■ 8 iesiri normale cu tranzistor ■ 2 iesiri rapide (PWM/PLS/PTO) 		
Dimensiuni (A x l x L)	130 x 70 x 90 ²		
Ethernet (RJ 45)	–		1
Legatura seriala (2)	1		
Referinta	TM200C24T		

Tensiune de alimentare	24 VDC		
Numarul de I/O digitale	40		
Intrari digitale	<ul style="list-style-type: none"> ■ 24 sink/sursa ■ tensiune de intrare 24 VDC 	<ul style="list-style-type: none"> ■ 4 intrari rapide pentru FC ■ 16 intrari standard 	<ul style="list-style-type: none"> ■ 4 intrari de mare viteza HSC
Iesiri digitale	<ul style="list-style-type: none"> ■ 16 iesiri de coborare ■ 14 iesiri normale cu tranzistor ■ 2 iesiri rapide (PWM/PLS/PTO) 		
Dimensiune (A x l x L)	130 x 70 x 90 ³		
Ethernet (RJ 45)	–	1	–
Legatura seriala (2)	1		1
Referinta	TM200C40U	TM200CE40U	TM200CE40T

(1) Controlerele M200 sunt furnizate cu:

- blocuri terminale cu suruburi detasabile pentru conectarea I/O
- o borna cu suruburi detasabile pentru conectarea alimentarii cu energie electrica
- un bloc de terminale cu suruburi detasabile pentru legatura seriala

(2) Fiecare controler logic M200 are incorporat un port de programare USB mini-B.

Easy Modicon M200 - Accesorii



Cartuse de extensie pentru controlere logice Easy Modicon M200 (1)

Descriere	Cartuse de extensie	
Detalii	1 legatura seriala suplimentara RS232C sau RS485, prindere cu surub	O conexiune aditionala RS485, prindere cu surub
Referinta	TMCR2SL1	TMCR2SL1A

Descriere	Cartuse I/O analogice		
Detalii	<ul style="list-style-type: none"> ■ 2 intrari analogice (rezolutie de 12 biti) configurabile ca: <ul style="list-style-type: none"> - 0...10 V tensiune - 0...20 mA/4...20 mA curent ■ conectare prin intermediul blocului de borne cu surub 	<ul style="list-style-type: none"> ■ 2 intrari analogice (rezolutie pe 12 biti) 0...10V/ 0...5V/ 0...20mA / 4...20mA ■ 1 iesire analogica (rezolutie pe 12 biti) 0...10V/ 0...5V/ 0...20mA / 4...20mA ■ conectare prin intermediul blocului de borne cu surub 	<ul style="list-style-type: none"> ■ 2 intrari de temperatura (rezolutie de 12 sau 14 biti in functie de semnalul de intrare) tip K, J, R, S, B, E, T, N, C, PT100, PT1000, NI100, NI1000 ■ conectare prin intermediul blocului de borne cu surub
Referinta	TMCR2AI2	TMCR2AM3	TMCR2TI2

Descriere	Cartuse I/O analogice	
Detalii	<ul style="list-style-type: none"> ■ 2 iesiri analogice (rezolutie pe 12 biti) 0...10 V tensiune ■ conectare prin intermediul blocului de borne cu surub 	<ul style="list-style-type: none"> ■ 2 iesiri analogice (rezolutie pe 12 biti) curent 4...20 mA ■ conectare prin intermediul blocului de borne cu surub
Referinta	TMCR2AQ2V	TMCR2AQ2C



Piese separate pentru controlerile logice Easy Modicon M200

Descriere	Capac pentru cartuse ¹	Baterie RTC ²
Referinta	TMARCOVER	TMARBAT1

Piese de schimb pentru controlerile logice Easy Modicon M200 ³

Descriere	Set de blocuri de borne pentru conectarea I/O la controlerile M200	
Detalii	Bloc terminal cu 3 cai pentru conectarea sursei de alimentare	Bloc terminal cu 4 cai pentru conectarea legaturii seriale
Referinta	TMARTB3	TMARTB4

Module de extensie

Descriere	Module de extensie Modicon TM3	
Detalii	Controlere logice Easy Modicon M200	
Referinta	(2)	

(1) Un cartus pentru controlere cu 16 si 24 I/O. Maximum doua cartuse pentru controlerile cu 32, 40 si 60 I/O, dintre care numai unul poate fi un cartus de comunicare.

(2) Consultati lista noastra de module de extensie compatibile pe pagina urmatoare.

Easy Modicon M200 controlere logice - Compatibilitate de produs

Compatibilitatea produselor										
Optiuni de extensie			Numarul si tipul de I/O	Controlere logice M200						
				TM200C16R	TM200C16U	TM200C16T				
Modicon TM3	Module digitale	TM3DI8	8 x 24V --- intrari sink/sursa							
		TM3DI16	16 x 24V --- intrari sink/sursa							
		TM3DI32K	32 x 24V --- intrari sink/sursa							
		TM3DQ8R	8 x 24V --- /240V iesiri releu							
		TM3DQ8T	8 x 24V --- iesiri tranzistori tip sursa							
		TM3DQ8U	8 x 24V --- iesiri tranzistori tip sink							
		TM3DQ16R	16 x 24V --- /240V iesiri releu							
		TM3DQ16T	16 x 24V --- iesiri tranzistori tip sursa							
		TM3DQ16U	16 x 24V --- iesiri tranzistori tip sink							
		TM3DQ32TK	16 x 24V --- sink tranzistor kimenet							
		TM2DRA16RT	32 x 24V --- iesiri tranzistori tip sink							
		TM3DM8R	4 x 24V --- intrari tip sink/sursa + 4 x 24V --- /240V iesiri releu							
		TM3DM24R	16 x 24V --- intrari sink/sursa + 8 x 24V --- /240V iesiri de releu							
		TM3RDM16R	8 x 24V --- intrari sink/sursa + 8 x 24V --- /240V iesiri de releu							
		TM3RDM32R	8 x 24V --- intrari sink/sursa + 8 x 24V --- /240V							
	Module analogice	TM3AI2H	2 intrari de tensiune/curent							
		TM3AI4	4 intrari de tensiune/curent							
		TM3TI4	4 intrari de tensiune/curent sau temperatura							
		TM3AI8	8 intrari de tensiune/curent							
		TM3TI8T	8 intrari de temperatura							
		TM3AQ2	2 iesiri de tensiune/curent							
		TM3AQ4	4 iesiri de tensiune/curent							
		TM3TM3	2 intrari de tensiune/curent sau temperatura + 1 iesire de tensiune/curent							
		TM3AM6	4 intrari de tensiune/curent + 2 iesiri de tensiune/curent							

Possible combinatii, pana la 4 module

Configuratie (1)(2)

Limite de configurare	Controlere logice							
	TM200C16R	TM200C16T	TM200C16U	TM200C24R TM200CE24R	TM200C24T TM200CE24T	TM200C24U TM200CE24U	TM200C32R TM200CE32R	TM200C40R TM200CE40R
Numarul maxim de iesiri tip tranzistor	130	137	137	130	140	140	132	132
Numarul maxim de iesiri tip releu	71	64	64	74	64	64	76	76

Limite de configurare	Controlere logice		
	TM200C40T TM200CE40T	TM200C40U TM200CE40U	TM200C60R
Numarul maxim de iesiri tip tranzistor	148	148	132
Numarul maxim de iesiri tip releu	64	64	88

(1) Modulele I/O digitale Modicon TM3 se conecteaza la controlerile logice Modicon M200 cu un maxim de 4 module I/O locale.

(2) Numarul maxim de module de expansiune Modicon TM3 poate fi redus de numarul de iesiri cu tranzistor sau iesiri cu releu utilizate.



09. Panouri industriale Easy Harmony Smart iPC

Easy Harmony Smart iPC - Panouri industriale all-in-one



Prezentare

Proiectate sa imbunatateasca capacitatile de fabricatie inteligente, de la control autonom pana la monitorizarea liniei de productie.

Caracteristici

15 inch / 15.6 inch (wide) / 18.5 inch (wide) - Ecran tactil analogic rezistiv

Disponibilitate

- 12~24V DC - tensiunea de intrare
- 0 - 55°C (temperatura de operare)
- Ecran tactil rezistiv potrivit aplicatiilor industriale
- Ecostruxure Machine SCADA expert preinstalat (variante trial)
- Suport pentru instalarea software-ului Vijeo Designer Windows Runtime
- Posibilitate de instalare Operator Terminal Expert Windows
- Timp de functionare

Usor de folosit

- Slot SATA 2.5 inch si slot M.2 usor de extins
- Port serial RS232/422/485
- Iesire video HDMI
- Instalarea panoului de sprijin si instalare tip VESA

Fiabilitate

- Carcasa din aliaj de aluminiu, proiectata pentru a imbunatati disiparea caldurii si imbunatateste stabilitatea echipamentului
- Memorie DDR integrata si unitate SSD mSATA preinstalata
- Grad de protectie IP65 a panoului frontal

Noul PC industrial Easy Harmony raspunde provocarilor IoT asigurand o comunicatie sigura de la produsele conectate pana la software-ul de aplicatii industriale.

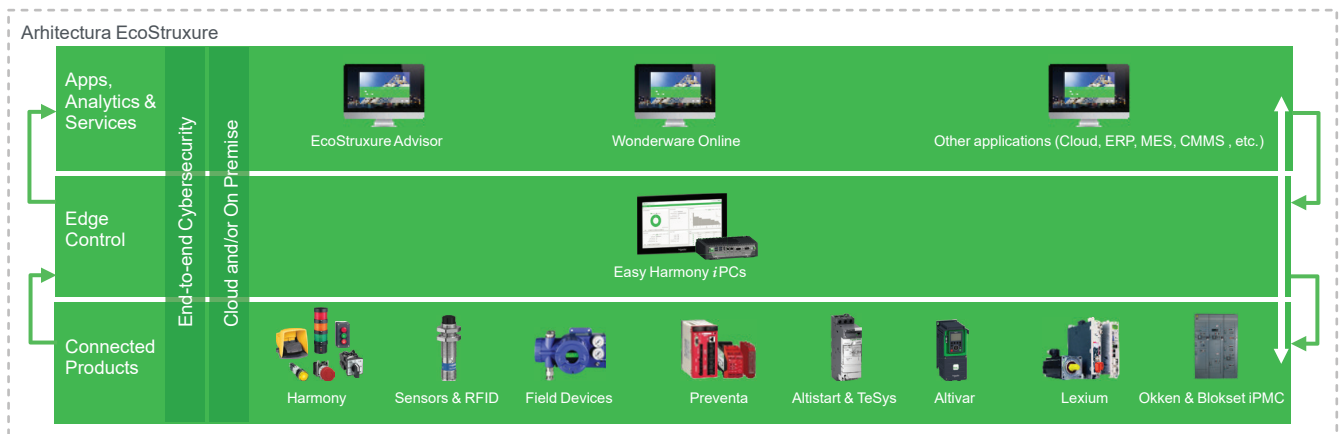

Easy Harmony Smart iPC - Panouri industriale all-in-one

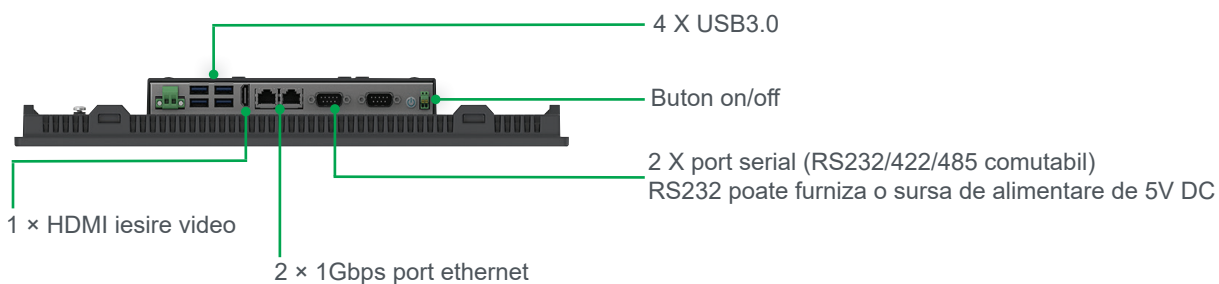
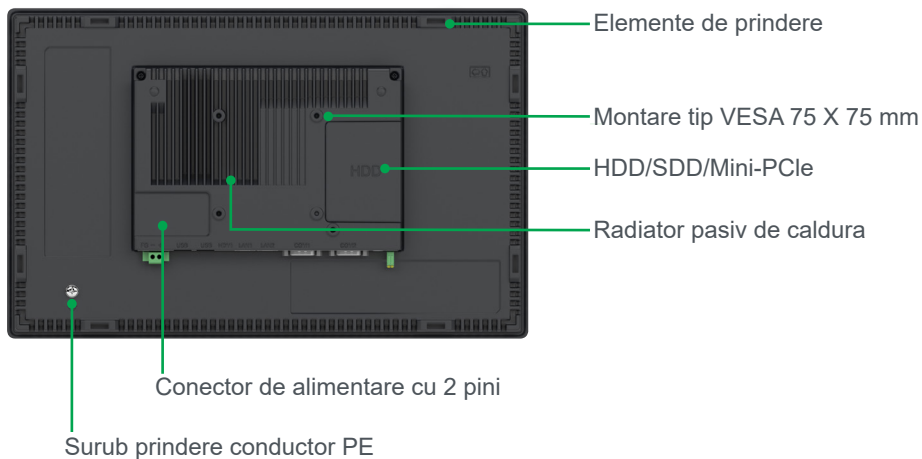

Ghid de selectie

Referinta comerciala	HMIPSOS742D1W01	HMIPSOS752D1W01	HMIPSPS752D1X01	HMIPSPS952D1X01
Vizualizare				
Dimensiune ecran	15"	15.6" (wide)		18.5" (wide)
Rezolutie LCD	XGA 1024 x 768 pizeli, 16M culori		FWXGA 1366 x 768 pixeli, 16M culori	
Performanta				
CPU	Intel Celeron 3855U 1.6GHz		Intel Core i5-6200U 2.3GHz	
Memorie DDR	4GB DDR4		8GB DDR4	
Stocare	1 x mSATA SSD 128GB			
Interfete				
Serial	2 x COMs (RS232/422/485)			
Ethernet	2 x RJ45 10/100/100Mbps			
USB	4 x USB3.0 Type A			
Video	1 x HDMI			
Slot de expansiune	1 x 2.5" SATAIII slot pentru HDD/SSD, 1 x M.2 (doar mSATA SSD)		1 x 2.5" SATAIII slot pentru HDD/SSD, 1 x M.2 (mSATA SSD / NVMe SSD)	
Alimentare si consum	12 ... 24Vdc (-15% ... +20%), maxim 60W			
Mediu	Temperatura de operare			
Umiditate	Cu stocare SSD si M.2: 0 ... 55°C (2 ... 131 °F), cu stocare HDD : 0 ... 45°C (2 ... 113 °F)			
Protectie IP	10 ... 95% RH, fara condens			
Metoda de racire	Panou fata IP65, spate IP20			
Tip de montare	Radiator pasiv, fara ventilator			
Certificate	Montarea panoului VESA			
Sistem de operare	CE			
Dimensiune si decupare	Win10 IoT Ent. LTSB (64bit EN MUI)			
	393 x 293 x 47 (mm) 383 x 283 (mm)	400 x 254 x 50.5 (mm) 390 x 244 (mm)	467 x 292.5 x 51.5 (mm) 457 x 283 (mm)	



10. Soluții de control pentru motoarele trifazate asincrone



Aplicatia 1

Sistem multipompa cu o pompa auxiliara - mentinerea unei presiuni constante in instalatia de apa menajera/ape uzate.

Solutia propusa

Folosirea unui convertizor de frecventa in mod automat, prin configurarea buclei PID, functie incorporata in convertizorul de frecventa **Easy Altivar 310**, si utilizarea unui traductor de presiune.

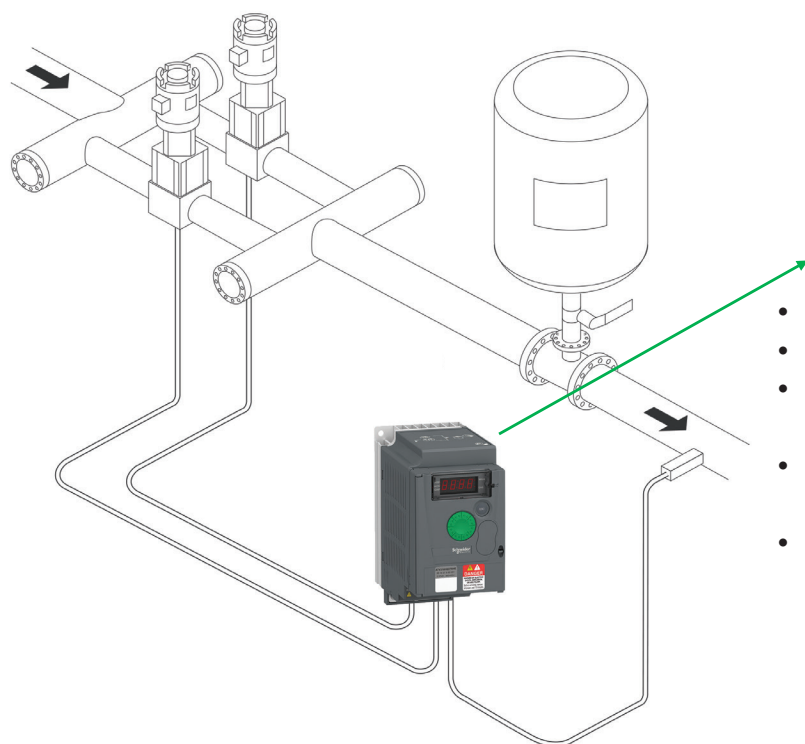

Easy Altivar 310

- Comunicatie Modbus integrata
- Functia PID incorporata
- Functii pornire oprire automata (Sleep/Wake-up)
- Reglarea limitarii curentului de pornire (mai mic de 1,5 In)
- Controlul unei pompe auxiliare de turatie fixa

Solutii de control pentru motoare trifazate asincrone

Aplicatia 2

O solutie de pornire a motoarelor asincrone ce mentine protectia in amonte de unitatea de actionare in cazul unui scurtcircuit.

Solutia propusa

Sunt posibile două tipuri de configuratii:

1. Unitate de actionare (Easy Altivar 310) + intreruptor de circuit (EasyPact TVS)
2. Unitate de actionare (Easy Altivar 310) + intreruptor de circuit (EasyPact TVS) si contactor: configuratie minimă cu un contactor atunci când este necesar un circuit de control



Intreruptor EasyPact TVS (protectie magneto-termica)

O solutie conceputa pentru controlul si protectia motoarelor de pana la 15kw



Contactor de linie EasyPact

Contactoarele cu 3 poli, de la 6 A la 630 A, sunt destinate aplicatiilor cu motor inductiv si contactoarele cu 4 poli, de la 16 A la 125 A, sunt pentru aplicatii AC1.



Easy Altivar 310

Convertizor de frecventa pentru motoare asincrone trifazate, de la 380 V la 460 V, cu o valoare nominala de la 0,37 kW / 0,5 CP la 11 kW / 15 CP

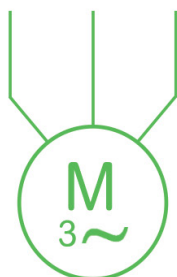

Motor asincron trifazat



Solutii de control pentru motoare trifazate asincrone

Aplicatia 3

Controlul mai multor motoare asincrone trifazate cu o singura unitate de frecventa variabila.

Solutia propusa

O unitate de frecventa variabila, din seria **Easy Altivar 310**, poate fi utilizata pentru a controla mai multe motoare in anumite aplicatii, cu conditia sa se ia in considerare proiectarea corecta si sa se asigure o protectie adecvata pentru fiecare motor.

Acest lucru ofera mai multe avantaje precum:

- un cost mai mic
- reducerea spatiului in tabloul electric
- reducerea complexitatii controlului

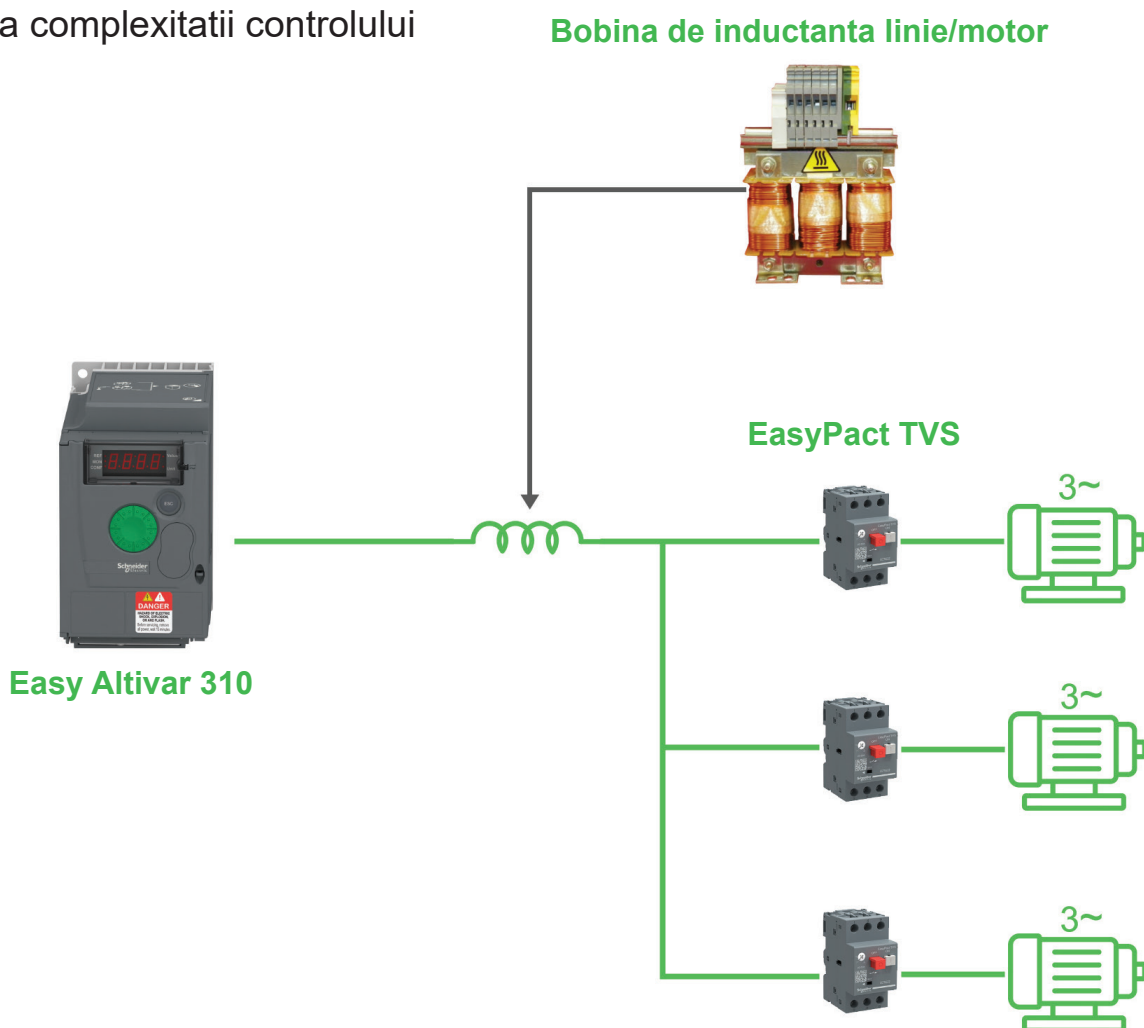

In momentul dimensionarii unei unitati de actionare cu frecventa variabila, valoarea nominala trebuie sa fie mai mare decat insumarea curentului tuturor motoarelor controlate.

Toate motoarele trebuie sa functioneze la aceeasi viteza in acelasi timp in momentul in care se doreste pornirea simultana a tuturor motoarelor



Aplicatia 4

Un grup industrial de pompare a apei menajere/apelor uzate.

Solutia propusa

Convertizoarele de frecventa **Easy Altivar 610** pot gestiona pana la 6 pompe pentru a mentine presiunea constanta in instalatia de apa.

In cazul unui sistem cu o singura pompa, in momentul in care se atinge turatia maxima, cererea crescuta va determina scaderea presiunii pe masura ce pompa isi parcurge curba, in timp ce in cazul unui sistem multipompa, scaderea presiunii determina pornirea celorlalte pompe succesiv in functie de necesarul de debit.

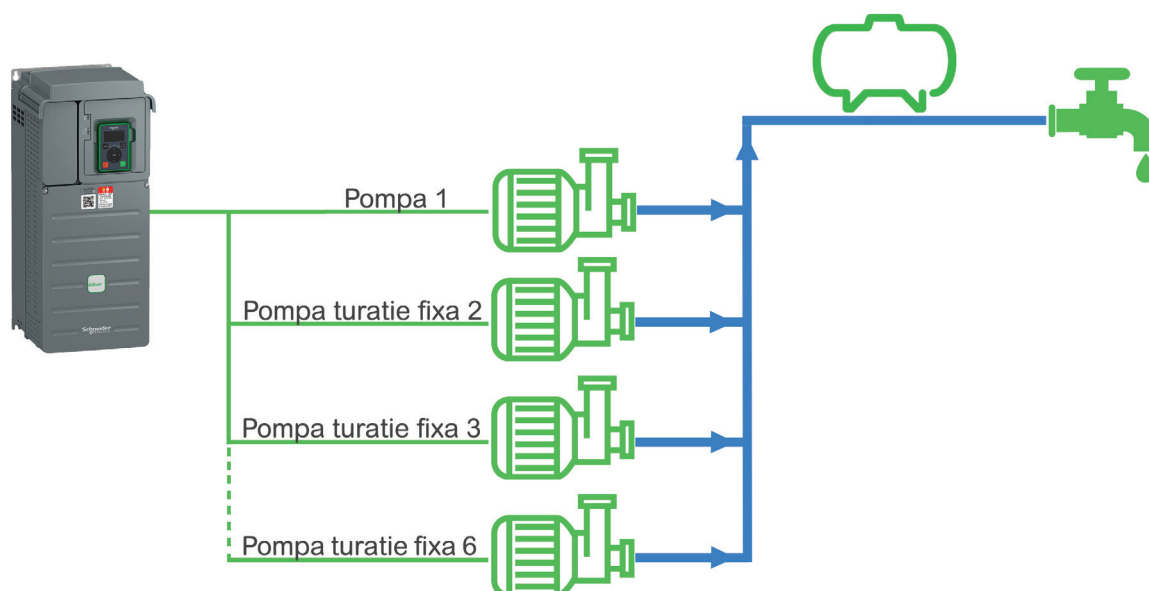

Life Is On

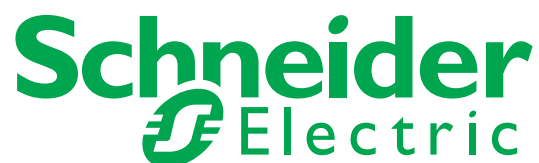

Aflati mai multe despre solutiile Easy accesand pagina web se.com/ro

Informatiile furnizate in aceasta documentatie contin descrieri generale si/sau caracteristici tehnice ale performantelor produselor cuprinse in ea. Aceasta documentatie nu este menita sa inlocuiasca si nu trebuie utilizata pentru a determina caracterul adecvat sau fiabilitatea acestor produse pentru aplicatiile specifice ale utilizatorilor. Este de datoria oricarui astfel de utilizator sau integrator sa efectueze o analiza de risc, o evaluare si o testare corespunzatoare si completa a produselor in ceea ce priveste aplicatia specifica relevanta sau utilizarea acestora. Nici Schneider Electric si nici una dintre filialele sau sucursalele sale nu vor fi responsabile sau raspunzatoare pentru utilizarea necorespunzatoare a informatiilor continute in prezentul document.

Schneider Electric Romania
Str. Gara Herastrau nr. 4,
Cladirea Green Court-A, Etaj 2,
Sector 2, Bucuresti, Romania
se.com/ro

© 2019 Schneider Electric. Toate drepturile rezervate. Life Is On Schneider Electric este o marca comerciala si este proprietatea Schneider Electric SE, a filialelor sale si a companiilor afiliate.