

## Circuit breakers - TeSys GV2, GV3, GV4, GV5 and GV6

Type of product	Range (400/415 V AC)	Pages
Presentation TeSys GV		B6/3
Magnetic and thermal magnetic circuit breakers TeSys GV2L, GV2LE, GV2P, GV2ME	0.06 or 15 kW	B6/11
Thermal magnetic circuit breakers - delayed tripping - For high current peak motors or 3-phase transformers TeSys GV2RT	0.09 or 11 kW	B6/18
Add-on blocks, accessories for GV2		
Magnetic and Thermal magnetic circuit breakers TeSys GV3L, GV3P	11 to 45 kW	B6/25
Add-on blocks, accessories		
Magnetic and Thermal magnetic circuit breakers TeSys GV4L, GV4LE, GV4P, GV4PE, GV4PEM, GV4PB	0.25 to 55 kW 1/2 to 60 HP	B6/31
Add-on blocks, accessories		
Thermal magnetic circuit breakers TeSys GV5P, GV6P	55 to 250 kW	B6/49
Add-on blocks, accessories		
<b>Equipement Circuit breakers - GB</b>		
Thermal magnetic circuit breakers TeSys GB		B6/57



# TeSys protection components

Motor circuit breakers GV2, GV3, GV4, GV5 and GV6

## Circuit breakers for motor protection and control

TeSys GV motor circuit breakers provide compact, reliable and efficient solutions for:

- isolation,
  - protection against short circuits and overloads,
  - On-Off manual control of motors from 0.06 to 250 kW.
- They are conforming to, depending of the versions, IEC/EN 60947-1, IEC/EN 60947-2, IEC/EN 60947-4-1 and UL 60497-4-1, CSA 22.2 n° 60497-4-1.

## TeSys GV protection technologies

TeSys GV are carried with 3 variants:

- Magnetic detection: GV2LE, GV2L, GV3L, GV4L, GV4LE for protection against short-circuit.
- Thermal-magnetic: GV2ME <sup>(1)</sup>, GV2P, GV3P, GV4P, GVAPE, GV5, GV6 for protection against short-circuits, overload, phase loss and phase unbalance.
- Advanced: GV4PEM combines GV4P protections and motor jam, long start, ground-fault protections.

With a magnetic circuit breaker, a thermal relay is frequently associated in order to have a short circuit protection and an overload protection.

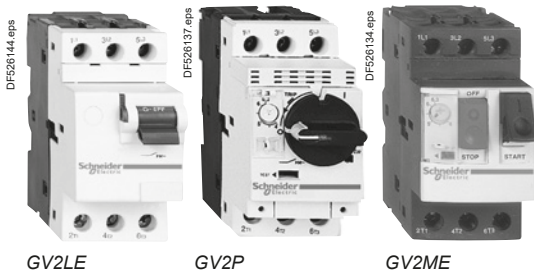

GV2LE

GV2P

GV2ME

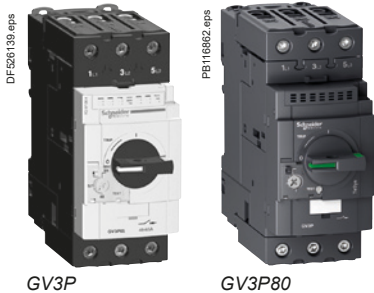

GV3P

GV3P80

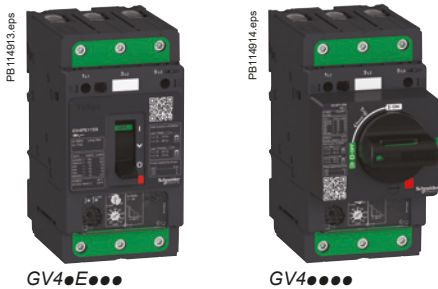

GV4E●●●

GV4●●●●



GV5P150F

GV6P500F

## GV2: 45 mm width, for motors up to 15 kW

The most commonly used circuit breaker. with a choice of about 100 auxiliaries and accessories. GV2 and TeSys D or K contactors can be easily assembled as a single block with one accessory.

The high GV2 electrical endurance (up to 100 000 operating cycles) makes it very suitable for direct manual motor control, especially GV2ME <sup>(1)</sup> (thermal-magnetic c.b., Ith up to 32 A).

Enclosure mounting is well adapted to GV2L and GV2P, with their possible extended rotary handle and visible trip indication.

## GV3: 55 mm width, for motors up to 45 kW

High performance breakers, high breaking capacity (Ics 100 kA/400 V for ratings up to 32 A, 50 kA up to 80 A).

Wide choice of auxiliaries / accessories, possible extended rotary handle. Visible tri indication.

Patented Everlink connectors provide everlasting connection (no re-tightening required).

Direct monoblock starter assembly with TeSys D contactors. No accessory required.

## GV4: 81 mm width, for motors up to 55 kW

State-of-the-art technology, GV4 is compact and robust. Electronic core of GV4P gives a great detection accuracy, with alarming and advanced protections for GV4PEM, GV4PB.

Magnetic, electronic thermal-magnetic, or electronic thermal magnetic with advanced protections versions.

Ratings up to 115 A with breaking capacity Ics of 25 kA/400 V (B series), 50 kA/400 V (N series) or 100 kA/400 V (S series).

## GV5: 105 mm width, for motors up to 110 kW / GV6: 140 mm width, for motors up to 250 kW

GV5 and GV6 with advanced thermal-magnetic trip unit provide more effective protection to high power motors in the most demanding appliances.

They provide protection to motors against overloads with selection of a trip class (5, 10 or 20), short-circuits, phase unbalance or phase loss.

Adjustable over-load and short circuit current settings provide flexibility.

Wide choice of auxiliaries/accessories are available for indication, control and operation.

<sup>(1)</sup> GV2ME●●AP are specific GV2ME references for CEE zone.

Circuit breakers

# TeSys protection components

Motor circuit breakers GV2, GV3, GV4, GV5 and GV6

## GV range overview

Molded case circuit breakers for motor protection and control

GV2							
	Protection against			Range (kW / 415 V AC)	Control	Terminals	Dimensions (W x H x D)
	Short-circuits	Overload	Jam, ground-fault, long start... (Multifunction - see page B6/6)				
GV2L	●			0.09 to 15	Rotary handle	Screw clamp	44.5 x 89 x 97 (with rotary handle)
GV2LE	●			0.06 to 15	Toggle	Screw clamp	44.5 x 89 x 78.5 (with toggle)
GV2P	●	●		0.06 to 15	Rotary handle	Screw clamp	44.5 x 89 x 97 (with rotary handle)
GV2ME <sup>(3)</sup>	●	●		0.06 to 11	Push button	Screw clamp, lug or spring	44.5 x 89 x 78.2 (with push button) <sup>(1)</sup>
GV3							
GV3L	●			11 to 45	Rotary handle	Lug, EverLink (BTR screw)	55 x 132 x 136 (with rotary handle)
GV3P	●	●		5.5 to 45			
GV4							
GV4L	●			0.25 to 55 kW	Rotary handle	Lug, EverLink (BTR screw)	81 x 156 x 116 (with toggle)
GV4LE	●				Toggle		81 X 156 x 165 (with rotary handle)
GV4P	●	●			Rotary handle		
GV4PE	●	●			Toggle		
GV4PEM	●	●	●		Toggle		
GV4PB	●	●	●	½ to 60 HP	Toggle		
GV5							
GV5P150●	●	●		55 to 110	Direct rotary handle	Lug, screw clamp	105 x 161 x 155 <sup>(2)</sup> (with direct rotary handle)
GV5P220●	●	●					
GV6							
GV6P320●	●	●		175 to 260	Direct rotary handle	Lug, screw clamp	140 x 255x 179 <sup>(2)</sup> (with direct rotary handle)
GV6P500●	●	●					

(1) 44.5 x 101 x 78.2 mm for GV2ME●●3.  
 (2) Depth without keylock.

Circuit breakers

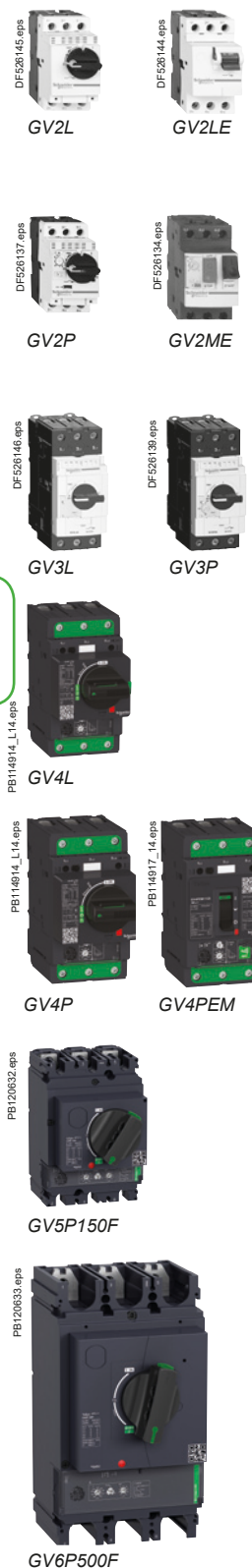

GV6P500F

# TeSys protection components

Motor circuit breakers GV2, GV3, GV4, GV5 and GV6

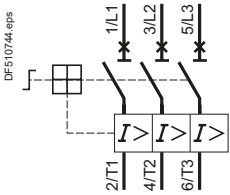

Thermal protection circuit breaker (with rotary control)

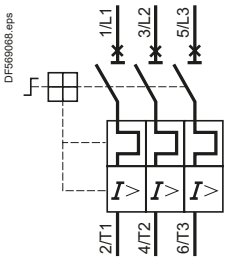

Thermal magnetic protection circuit breaker (with rotary control)

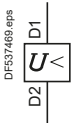

Voltage trip

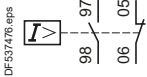

Fault signalling

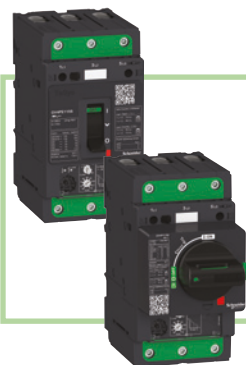

## Basic functions

### Short circuit protection (magnetic/thermal magnetic circuit breakers)

It provides a protection of the installation against short-circuit by an instantaneous trip of the circuit breaker. The tripping is obtained by means of a magnetic element incorporated in the motor circuit breaker or by an electronic detection (GV4P, GV5 and GV6).

The magnetic tripping threshold is not adjustable, except on GV4L, and is a fixed ratio of the maximum setting current  $I_n$ .

### Overload protection (thermal magnetic circuit breakers)

It provides a protection of the motor against overload. When current drawn by the motor is above its rated current, this continuous overcurrent lead to increase of motor internal temperature and reduce motor life time. Use of suitable protective device shall avoid this damage to the motor. This is obtained by means of a thermal element incorporated in the motor circuit breaker, or by sensors for electronic products (GV4P, GV5 and GV6).

An automatic compensation for ambient temperature variations is also provided. The rated operational current of the motor is displayed by turning a graduated knob.

### Motor ON/OFF control

The circuit breaker provides a local manual control of the motor when used on its own (without contactor). The operation is possible by push buttons, toggle, or a single rotary handle.

### Contacts position indication

Because they are suitable for isolation, the circuit breakers, in the open position, provide an adequate isolation distance and indicate the accurate position of the moving contacts by the position of the operators.

## Additional functions

They are provided by additional modules.

### Under voltage protection

Trips the circuit breaker in case of under voltage. The user is therefore protected against sudden starting of the machine when normal voltage is restored. Circuit breaker reset and/or start button "I" has to be pressed to restart the motor.

### Remote off-power

Circuit breaker can be remotely tripped with the addition of a shunt trip.

### Off-power locking

The operators on both open-mounted and enclosed motor circuit breakers can be locked in the off position "O" by up to 3 padlocks.

## Motor circuit breakers versus fuse protection ?

Circuit breakers are a common solution for protecting motor against short circuits and overloads.

As a comparison, a fuse based solution can only provide a partial protection depending on the choice of the fuse type and rating. The thermal magnetic circuit breaker is adjustable and can be fine-tuned to the practical motor load.

The fuse based solution offers a very fast protection.

## TeSys protection components

Motor circuit breakers GV2, GV3, GV4, GV5 and GV6

PB114517.eps



### Advanced protections embedded on GV4PEM, GV4PB (multifunction)

In addition to basic protections, GV4PEM, GV4PB embed protections against:

- Long start (high inertia, resistive torque machines)
- Jam (overtorque, machine failure)
- Ground-fault (reduced isolation)
- Unbalanced (phase currents are not equal)
- Phase loss (1 or 2 phases missing).

Fully configurable-advanced protections:

- wireless with 'EcoStruxure Power Device App' application for Android smartphone through NFC (near field communication).

DB424773.eps

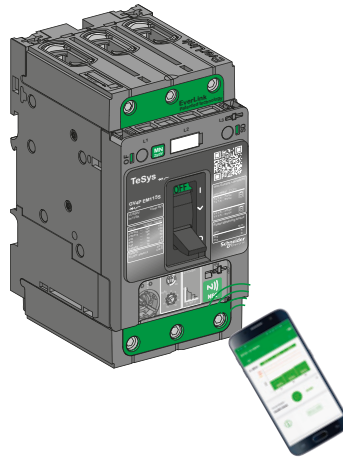

- with EcoStruxure Power Commission software on a computer connected to the test socket through a configuration and maintenance module.

DB424766.eps

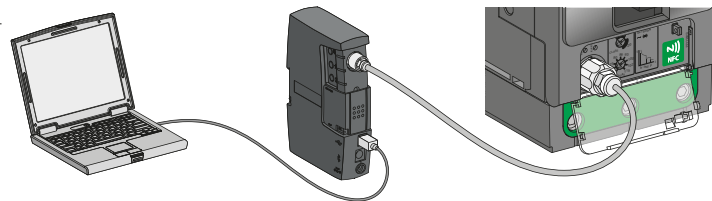

Remote indications:

GV4PEM, GV4PB circuit breaker may be equipped with an SDx alarming / fault differentiation module to prevent to trip or to identify the type of fault after a trip (see page B6/44).

DB424831.eps

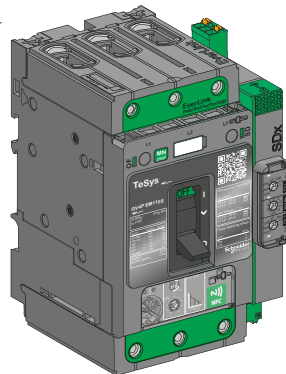

# TeSys protection components

Motor circuit breakers GV2, GV3, GV4, GV5 and GV6



## EverLink technology for TeSys GV3 and GV4

TeSys GV3 and GV4 features a cable connection method with patented creep-compensating technology built directly into the terminal — EverLink:

- With EverLink connectors, save space and time during panel assembly.
- Bare cable connections are as safe as compression lug ones.

### No overheating connections - EverLink creep-compensated terminals for GV3 and GV4

The EverLink patented technology for terminals dramatically reduces the risk of loose bare cables due to copper creeping. Vibration withstand is improved and periodic re-tightening is no longer needed.

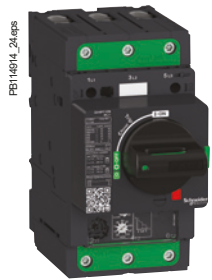

EverLink terminals, with BTR screws



The clamp connectors which don't need re-tightening.

#### Creeping phenomena

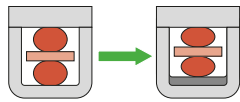

Copper conductors are subject to creep with the time, reducing the contact pressure in conventional clamps

During the tightening a force is applied on the conductors and on a spring.

Maintaining of cables assured by pressure of spring and crimping of conductor on the contact plate.

The spring compensates for cable conductor creep. Tightening force is assured.

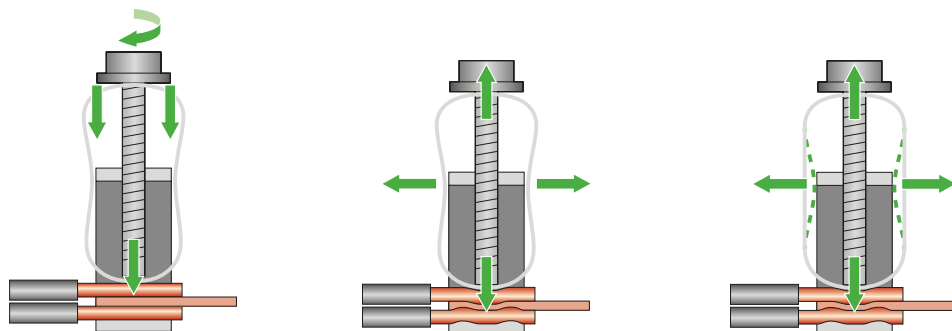

Circuit breakers

# TeSys protection components

Motor circuit breakers GV2, GV3, GV4, GV5 and GV6

## Auxiliary functions provided by add-on blocks

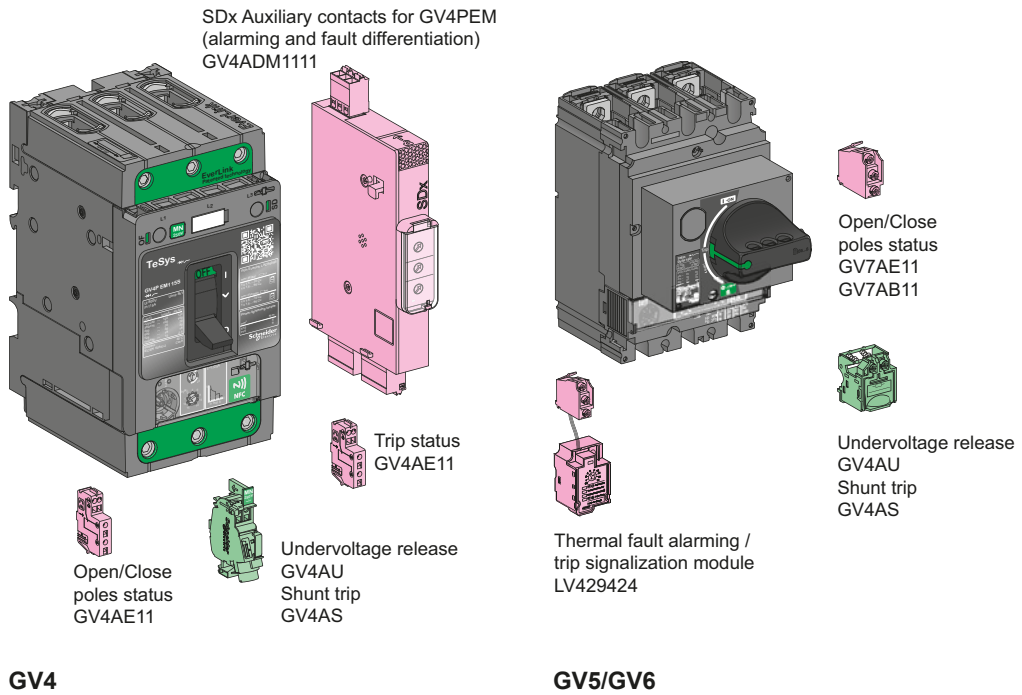
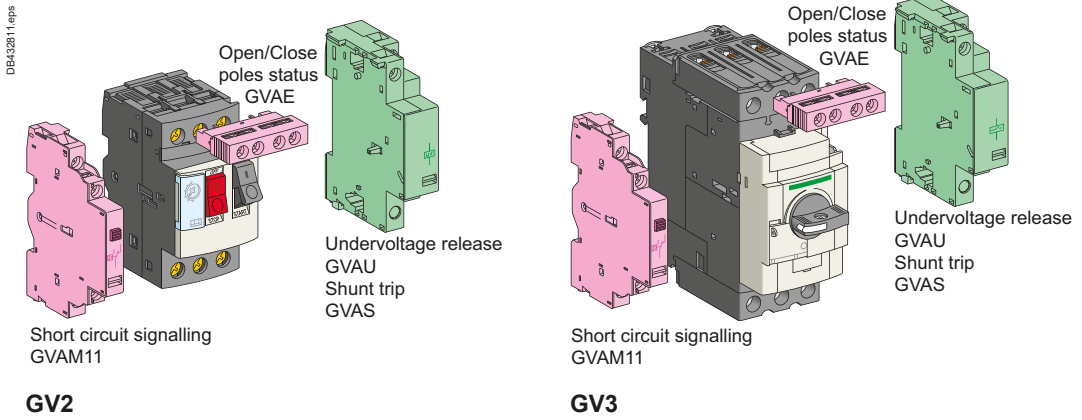

- Auxiliary contacts add-on blocks**  
 For control, alarms, automatic actions:
- Instantaneous indication of the position of the circuit breaker contacts
  - Trip indication,
  - Alarming.

- Trip units**  
 For remote tripping of circuit breaker:
- Shunt trip / MX, trips the circuit breaker when powered
  - Undervoltage release / MN, trips the circuit breaker when voltage is loss.

Circuit breakers



# TeSys protection components

Motor circuit breakers GV2, GV3, GV4, GV5 and GV6

## Compact power circuits wiring with of GV2 + TeSys D contactors <sup>(1)</sup>

### Busbars and combination blocks

Power busbars and combinations blocks provide a compact solution for assembling a group of motor starters. They save wiring time and provide a clear finish aspect.

These solutions are available for GV2 circuit breakers + TeSys D contactors.

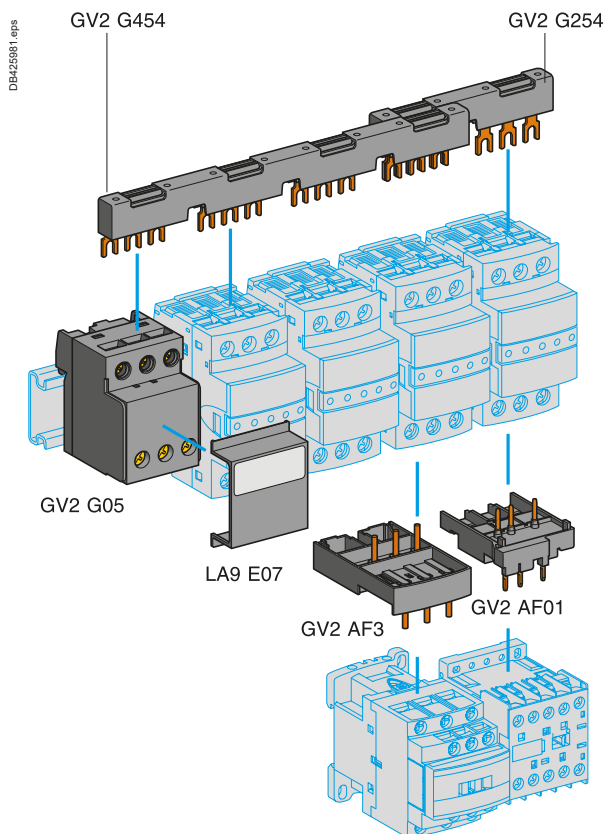

Circuit breakers

## Quick control circuits wiring of GV2, GV3 + TeSys D contactors <sup>(1)</sup>

### TeSys SoLink RJ45 connection modules

The LAD5C connection modules ensure compatibility of GV2, GV3 circuit breaker + TeSys D contactor assemblies with the RJ45 connection system. Require screw clamp terminals. Benefits are reduced wiring time, reliable connection.

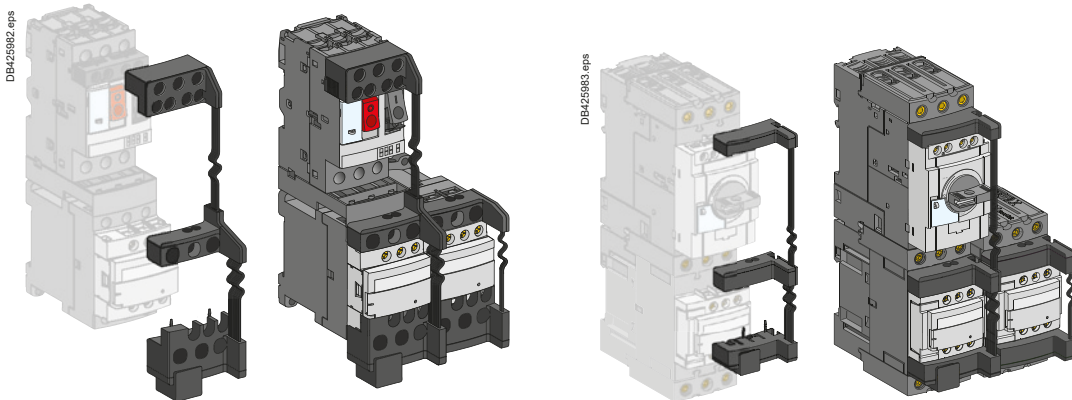

SoLink for GV2 + TeSys D Direct, Reverse assemblies

SoLink for GV3 + TeSys D Direct, Reverse assemblies

<sup>(1)</sup> Details on these solution in chapter B2 of TeSys catalogue.



# TeSys GV2

0.06 to 15 kW



Circuit  
breakers

## References - TeSys GV2 - 0.06 to 15 kW

### TeSys protection components

#### Magnetic motor circuit breakers GV2L



GV2L10

#### Motor circuit breakers from 0.09 to 15 kW

##### GV2L: Control by rotary knob, connection by screw clamp terminals

Standard power ratings of 3-phase motors 50/60 Hz in category AC-3									Magnetic protection rating	Tripping current I <sub>d</sub> ± 20 %	Use in association with thermal overload relay (class 10 A)	Reference
400/415 V			500 V			690 V						
P	I <sub>cu</sub>	I <sub>cs</sub> <sup>(1)</sup>	P	I <sub>cu</sub>	I <sub>cs</sub> <sup>(1)</sup>	P	I <sub>cu</sub>	I <sub>cs</sub> <sup>(1)</sup>				
kW	kA		kW	kA		kW	kA		A	A		
0.09	*	*	-	-	-	-	-	-	0.4	5	LRD 03	GV2L03
0.12	*	*	-	-	-	0.37	*	*	0.63	8	LRD 04	GV2L04
0.18	*	*	-	-	-	-	-	-	0.63	8	LRD 04	GV2L04
-	-	-	-	-	-	0.55	*	*	1	13	LRD 05	GV2L05
0.25	*	*	-	-	-	-	-	-	1	13	LRD 05	GV2L05
-	-	-	-	-	-	0.75	*	*	1	13	LRD 06	GV2L05
0.37	*	*	0.37	*	*	-	-	-	1	13	LRD 05	GV2L05
0.55	*	*	0.55	*	*	1.1	*	*	1.6	22.5	LRD 06	GV2L06
-	-	-	0.75	*	*	-	-	-	1.6	22.5	LRD 06	GV2L06
0.75	*	*	1.1	*	*	1.5	4	100	2.5	33.5	LRD 07	GV2L07
1.1	-	-	-	-	-	-	-	-	-	-	LRD 08	GV2L08
1.5	*	*	1.5	*	*	3	4	100	4	51	LRD 08	GV2L08
-	-	-	-	-	-	-	-	-	-	-	LRD 08	GV2L08
2.2	*	*	3	*	*	4	4	100	6.3	78	LRD 10	GV2L10
3	*	*	4	10	100	5.5	4	100	10	138	LRD 12	GV2L14
4	-	-	-	-	-	-	-	-	-	-	LRD 14	GV2L14
-	-	-	-	-	-	7.5	4	100	10	138	LRD 14	GV2L14
-	-	-	-	-	-	9	4	100	14	170	LRD 16	GV2L16
5.5	50	50	7.5	10	75	11	4	100	14	170	LRD 16	GV2L16
7.5	50	50	9	10	75	15	4	100	18	223	LRD 21	GV2L20
9	50	50	11	10	75	18.5	4	100	25	327	LRD 22	GV2L22
11	50	50	15	10	75	-	-	-	25	327	LRD 22	GV2L22
15	50	50	18.5	10	75	22	4	100	32	416	LRD 32	GV2L32

(1) As % of I<sub>cu</sub>. Associated current limiter or fuses, where required.

\* > 100 kA.

# References - TeSys GV2 - 0.06 to 15 kW

## TeSys protection components

### Magnetic motor circuit breakers GV2LE

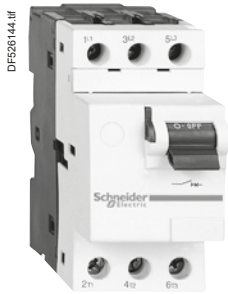

GV2LE10

Magnetic motor circuit breakers from 0.06 to 15 kW											Use in association with thermal overload relay	Reference
GV2LE: control by rocker lever, connection by screw clamp terminals												
Standard power ratings of 3-phase motors 50/60 Hz in category AC-3									Magnetic protection rating	Tripping current I <sub>d</sub> ± 20 %		
400/415 V			500 V			690 V						
P	I <sub>cu</sub>	I <sub>cs</sub> <sup>(1)</sup>	P	I <sub>cu</sub>	I <sub>cs</sub> <sup>(1)</sup>	P	I <sub>cu</sub>	I <sub>cs</sub> <sup>(1)</sup>	A	A		
kW	kA		kW	kA		kW	kA		A	A		
0.06	*	*	-	-	-	-	-	-	0.4	5	LR2 K0302	GV2LE03
0.09	*	*	-	-	-	-	-	-	0.4	5	LR2 K0304	GV2LE03
0.12	*	*	-	-	-	0.37	*	*	0.63	8	LR2 K0304	GV2LE04
0.18	*	*	-	-	-	-	-	-	0.63	8	LR2 K0305	GV2LE04
-	-	-	-	-	-	0.55	*	*	1	13	LR2 K0305	GV2LE05
0.25	*	*	-	-	-	-	-	-	1	13	LR2 K0306	GV2LE05
-	-	-	-	-	-	0.75	*	*	1	13	LR2 K0306	GV2LE05
0.37	*	*	0.37	*	*	-	-	-	1	13	LR2 K0306	GV2LE05
0.55	*	*	0.55	*	*	1.1	*	*	1.6	22.5	LR2 K0307	GV2LE06
-	-	-	0.75	*	*	-	-	-	1.6	22.5	LR2 K0307	GV2LE06
0.75	*	*	1.1	*	*	1.5	3	75	2.5	33.5	LR2 K0308	GV2LE07
1.1	*	*	-	-	-	-	-	-	2.5	33.5	LR2 K0308	GV2LE07
1.5	*	*	1.5	*	*	3	3	75	4	51	LR2 K0310	GV2LE08
-	-	-	2.2	*	*	-	-	-	4	51	LR2 K0312	GV2LE08
2.2	*	*	3	50	100	4	3	75	6.3	78	LR2 K0312	GV2LE10
3	*	*	4	10	100	5.5	3	75	10	138	LR2 K0314	GV2LE14
4	*	*	5.5	10	100	-	-	-	10	138	LR2 K0316	GV2LE14
-	-	-	-	-	-	7.5	3	75	10	138	LRD 14	GV2LE14
-	-	-	-	-	-	9	3	75	14	170	LRD 16	GV2LE16
5.5	15	50	7.5	6	75	11	3	75	14	170	LR2 K0321	GV2LE16
7.5	15	50	9	6	75	15	3	75	18	223	LRD 21	GV2LE20
9	15	40	11	4	75	18.5	3	75	25	327	LRD 22	GV2LE22
11	15	40	15	4	75	-	-	-	25	327	LRD 22	GV2LE22
15	10	50	18.5	4	75	22	3	75	32	416	LRD 32	GV2LE32

(1) As % of I<sub>cu</sub>.  
\* > 100 kA.

Circuit breakers

## TeSys protection components

## Thermal-magnetic motor circuit breakers GV2ME

DF526134.tif



GV2ME10

## Motor circuit breakers from 0.06 to 15 kW / 400 V, with screw clamp terminals

## GV2ME with pushbutton control

Standard power ratings of 3-phase motors  
50/60 Hz in category AC-3

400/415 V			500 V			690 V			Setting range of thermal trips <sup>(2)</sup>	Magnetic tripping current I <sub>d</sub> ± 20 %	Reference
P	I <sub>cu</sub>	I <sub>cs</sub> <sup>(1)</sup>	P	I <sub>cu</sub>	I <sub>cs</sub> <sup>(1)</sup>	P	I <sub>cu</sub>	I <sub>cs</sub> <sup>(1)</sup>			
kW	kA	%	kW	kA	%	kW	kA	%	A	A	
–	–	–	–	–	–	–	–	–	0.1...0.16	1.5	GV2ME01
0.06	*	*	–	–	–	–	–	–	0.16...0.25	2.4	GV2ME02
0.09	*	*	–	–	–	–	–	–	0.25...0.40	5	GV2ME03
0.12	*	*	–	–	–	0.37	*	*	0.40...0.63	8	GV2ME04
0.18	*	*	–	–	–	–	–	–			
0.25	*	*	–	–	–	0.55	*	*	0.63...1	13	GV2ME05
0.37	*	*	0.37	*	*	–	–	–	1...1.6	22.5	GV2ME06
0.55	*	*	0.55	*	*	0.75	*	*			
–	–	–	0.75	*	*	1.1	*	*			
0.75	*	*	1.1	*	*	1.5	3	75	1.6...2.5	33.5	GV2ME07
1.1	*	*	1.5	*	*	2.2	3	75	2.5...4	51	GV2ME08
1.5	*	*	2.2	*	*	3	3	75			
2.2	*	*	3	50	100	4	3	75	4...6.3	78	GV2ME10
3	*	*	4	10	100	5.5	3	75	6...10	138	GV2ME14
4	*	*	5.5	10	100	7.5	3	75			
5.5	15	50	7.5	6	75	9	3	75	9...14	170	GV2ME16
–	–	–	–	–	–	11	3	75			
7.5	15	50	9	6	75	15	3	75	13...18	223	GV2ME20
9	15	40	11	4	75	18.5	3	75	17...23	327	GV2ME21
11	15	40	15	4	75	–	–	–	20...25	327	GV2ME22 <sup>(3)</sup>
15	10	50	18.5	4	75	22	3	75	24...32	416	GV2ME32

## Motor circuit breakers from 0.06 to 15 kW / 400 V, with lugs

To order thermal magnetic circuit breakers with connection by lugs, add the digit **6** to the end of reference selected above.

Example: **GV2ME08** becomes **GV2ME086**.

## Thermal magnetic circuit breakers GV2 ME with built-in auxiliary contact block

With instantaneous auxiliary contact block (composition, see page B6/21):

- GV AE1, add suffix **AE1TQ** to the motor circuit breaker reference selected above.  
Example: **GV2ME01AE1TQ**.
- GV AE11, add suffix **AE11TQ** to the motor circuit breaker reference selected above.  
Example: **GV2ME01AE11TQ**.
- GV AN11, add suffix **AN11TQ** to the motor circuit breaker reference selected above.  
Example: **GV2ME01AN11TQ**.

These circuit breakers with built-in contact block are sold in lots of 20 units in a single pack.

<sup>(1)</sup> As % of I<sub>cu</sub>.

<sup>(2)</sup> The thermal trip setting must be within the range marked on the graduated knob.

<sup>(3)</sup> Maximum rating which can be mounted in enclosures **GV2MC** or **MP**, please consult your Regional Sales Office.

\* > 100 kA.

## TeSys protection components

Thermal-magnetic motor circuit breakers GV2ME - UL applications

DF520134-1R



GV2ME10

Motor circuit breakers from 3/4 to 20 HP / 460 V, with screw clamp terminals											
GV2ME with pushbutton control											
Thermal setting (A)	Maximum Horsepower ratings								Group Motor applications Max. Fuse or Circuit breaker (A)	Reference	
	Single-Phase			Three-Phase							
	115 V	200 V	230 V	115 V	200 V	230 V	460 V	575 V			
0.1...0.16	-	-	-	-	-	-	-	-	-	450	GV2ME01
0.16...0.25	-	-	-	-	-	-	-	-	-	450	GV2ME02
0.25...0.40	-	-	-	-	-	-	-	-	-	450	GV2ME03
0.40...0.63	-	-	-	-	-	-	-	-	-	450	GV2ME04
0.63...1	-	-	-	-	-	-	-	1/2	-	450	GV2ME05
1...1.6	-	-	1/10	-	-	-	3/4	3/4	-	450	GV2ME06
1.6...2.5	-	1/6	1/6	-	1/2	1/2	1	1.5	-	450	GV2ME07
2.5...4	1/8	1/4	1/3	-	3/4	3/4	2	3	-	450	GV2ME08
4...6.3	1/4	1/2	1/2	3/4	1	1.5	3	5	-	450	GV2ME10
6...10	1/2	1	1.5	1	2	3	5	7.5	-	450	GV2ME14
9...14	3/4	2	2	2	3	3	10	10	-	450	GV2ME16
13...18	1	2	3	2	5	5	10	15	-	450	GV2ME20
17...23	1.5	3	3	3	5	7.5	15	20	-	450	GV2ME21
20...25	2	-	-	-	7.5	7.5	15	20	-	450	GV2ME22
24...32	2	5	5	5	7.5	10	20	25	-	450	GV2ME32

Circuit breakers

# References - TeSys GV2 - 0.06 to 15 kW

## TeSys protection components

### Thermal-magnetic motor circuit breakers GV2ME

DF526135.tif



GV2ME●●3

#### Motor circuit breakers from 0.06 to 11 kW, with spring terminal connections

GV2ME <sup>(1)</sup> with pushbutton control									
Standard power ratings of 3-phase motors 50/60 Hz in category AC-3						Setting range of thermal trips <sup>(3)</sup>	Magnetic tripping current I <sub>d</sub> ± 20 %	Reference	
400/415 V			500 V						
P	I <sub>cu</sub>	I <sub>cs</sub> <sup>(2)</sup>	P	I <sub>cu</sub>	I <sub>cs</sub> <sup>(2)</sup>				
kW	kA	%	kW	kA	%	A	A		
-	-	-	-	-	-	0.1...0.16	1.5	GV2ME013	
0.06	*	*	-	-	-	0.16...0.25	2.4	GV2ME023	
0.09	*	*	-	-	-	0.25...0.40	5	GV2ME033	
0.12	*	*	-	-	-	0.40...0.63	8	GV2ME043	
0.18	*	*	-	-	-	0.63...1	13	GV2ME053	
0.25	*	*	0.37	*	*	1...1.6	22.5	GV2ME063	
0.37	*	*	0.37	*	*	1.6...2.5	33.5	GV2ME073	
0.55	*	*	0.55	*	*	2.5...4	51	GV2ME083	
0.75	*	*	0.75	*	*	4...6.3	78	GV2ME103	
1.1	*	*	1.1	*	*	6...10	138	GV2ME143	
1.5	*	*	1.5	*	*	9...14	170	GV2ME163	
2.2	*	*	2.2	*	*	13...18	223	GV2ME203	
3	*	*	3	50	100	17...23	327	GV2ME213	
4	*	*	4	10	100	20...25	327	GV2ME223	
5.5	15	50	5.5	6	75				
7.5	15	50	7.5	6	75				
9	15	40	9	4	75				
11	15	40	11	4	75				
11	15	40	15	4	75				

Contact blocks					
Description	Mounting	Maximum number	Type of contacts	Sold in lots of	Unit reference
Instantaneous auxiliary contacts	Front	1	N/O + N/C	10	GVAE113
			N/O + N/O	10	GVAE203
	LH side	2	N/O + N/C	1	GVAN113
			N/O + N/O	1	GVAN203

Accessory			
Description	Application	Sold in lots of	Unit reference
Cable end reducer	For connection of conductors from 1 to 1.5 mm <sup>2</sup>	20	LA9D99

(1) For connection of conductors from 1 to 1.5 mm<sup>2</sup>, the use of an LA9 D99 cable end reducer is recommended.  
 (2) Maximum rating which can be mounted in enclosures GV2MC or MP, please consult your Regional Sales Office  
 (3) The thermal trip setting must be within the range marked on the graduated knob.  
 \* > 100 kA.

Circuit breakers

DF53988.eps

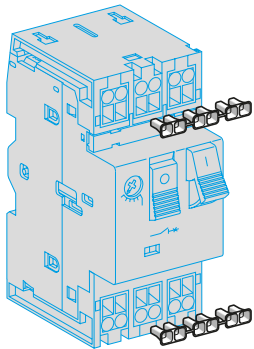

LA9 D99



# TeSys protection components

## Thermal-magnetic motor circuit breakers GV2P

DF526/137.fr



GV2P10

Motor circuit breakers from 0.06 to 30 kW / 400 V											
Standard power ratings of 3-phase motors 50/60 Hz in category AC-3									Setting range of thermal trips (2)	Magnetic tripping current I <sub>d</sub> ± 20 %	Reference
400/415 V			500 V			690 V					
P	I <sub>cu</sub>	I <sub>cs</sub> (1)	P	I <sub>cu</sub>	I <sub>cs</sub> (1)	P	I <sub>cu</sub>	I <sub>cs</sub> (1)	A	A	
<b>GV2 P: control by rotary knob</b>											
Screw clamp terminals											
–	–	–	–	–	–	–	–	–	0.1...0.16	1.5	GV2P01
0.06	*	*	–	–	–	–	–	–	0.16...0.25	2.4	GV2P02
0.09	*	*	–	–	–	–	–	–	0.25...0.40	5	GV2P03
0.12	*	*	–	–	–	0.37	*	*	0.40...0.63	8	GV2P04
0.18	*	*	–	–	–	–	–	–	–	–	–
0.25	*	*	–	–	–	0.55	*	*	0.63...1	13	GV2P05
0.37	*	*	0.37	*	*	–	–	–	1...1.6	22.5	GV2P06
0.55	*	*	0.55	*	*	0.75	*	*	–	–	–
0.75	*	*	1.1	*	*	1.5	8	100	1.6...2.5	33.5	GV2P07
1.1	*	*	1.5	*	*	2.2	8	100	2.5...4	51	GV2P08
2.2	*	*	3	*	*	4	6	100	4...6.3	78	GV2P10
3	*	*	5	50	100	5.5	6	100	6...10	138	GV2P14
5.5	*	*	7.5	42	75	9	6	100	9...14	170	GV2P16
–	–	–	–	–	–	11	6	100	–	–	–
7.5	50	50	9	10	75	15	4	100	13...18	223	GV2P20
9	50	50	11	10	75	18.5	4	100	17...23	327	GV2P21
11	50	50	15	10	75	–	–	–	20...25	327	GV2P22
15	50	50	18.5	10	75	22	4	100	24...32	416	GV2P32

How to use the table : select your load operating voltage, then select its standard power value (below, in the same column). The appropriate circuit breaker is in the extreme right column, in the corresponding row.

Example: GV2P04 can protect 0.12 and 0.18 kW under 400/415 V, and 0.18 kW under 440 V, and 0,37 kW under 690 V. No 500 V standard power value can fit GV2P04.

### Motor circuit breakers up to 50 HP / 600 V, UL 60947-4-1 type E

GV2 (3)

To obtain a GV2 P motor circuit breaker, UL 60947-4-1 type E, use the following with the circuit breaker:

- a "Large Spacing" adapter **GV2GH7**.

Circuit breakers

### Motor circuit breakers from 3/4 to 20 HP / 460 V, with screw clamp terminals

GV2P with rotary handle

Thermal setting (A)	Maximum Horsepower ratings (4)									Group Motor applications Max. Fuse or Circuit breaker (A)	Reference
	Single-Phase			Three-Phase							
	115 V	200 V	230 V	115 V	200 V	230 V	460 V	575 V			
0.1...0.16	–	–	–	–	–	–	–	–	–	450	GV2P01
0.16...0.25	–	–	–	–	–	–	–	–	–	450	GV2P02
0.25...0.40	–	–	–	–	–	–	–	–	–	450	GV2P03
0.40...0.63	–	–	–	–	–	–	–	–	–	450	GV2P04
0.63...1	–	–	–	–	–	–	–	1/2	1/2	450	GV2P05
1...1.6	–	–	1/10	–	–	–	3/4	3/4	3/4	450	GV2P06
1.6...2.5	–	1/6	1/6	–	1/2	1/2	1	1.5	1.5	450	GV2P07
2.5...4	1/8	1/4	1/3	–	3/4	3/4	2	3	3	450	GV2P08
4...6.3	1/4	1/2	1/2	3/4	1	1.5	3	5	5	450	GV2P10
6...10	1/2	1	1.5	1	2	3	5	7.5	7.5	450	GV2P14
9...14	3/4	2	2	2	3	3	10	10	10	450	GV2P16
13...18	1	2	3	2	5	5	10	15	15	450	GV2P20
17...23	1.5	3	3	3	5	7.5	15	20	20	450	GV2P21
20...25	2	–	–	–	7.5	7.5	15	20	20	450	GV2P22
24...32	2	5	5	5	7.5	10	20	25	25	450	GV2P32

(1) As % of I<sub>cu</sub>.

(2) The thermal trip setting must be within the range marked on the graduated knob.

(3) Accessory: see page B6/23.

(4) 3P FLA corresponding values: see page A6/58.

\* > 100 kA.

## TeSys protection components

## Thermal-magnetic circuit breakers GV2RT

PB111853.eps



GV2RT

## For motors with high current peak on starting

## Control by rocker lever

Standard power ratings of 3-phase motors 50/60 Hz in category AC-3					Setting range of thermal trips (1) A	Magnetic tripping current I <sub>d</sub> ± 20 % A	Reference
220/ 230 V	400/ 415 V	440 V	500 V	690 V			
kW	kW	kW	kW	kW			
0.06	0.09	0.09 0.12	–	–	0.25...0.40	8	GV2RT03
–	0.12 0.18	0.18	–	0.37	0.40...0.63	13	GV2RT04
0.09 0.12	0.25 0.37	0.25 0.37	0.37	0.55	0.63...1	22	GV2RT05
0.18 0.25	0.37 0.55	0.37 0.55	0.37 0.55 0.75	0.75 1.1	1...1.6	33	GV2RT06
0.37	0.75	0.75 1.1	1.1	1.5	1.6...2.5	51	GV2RT07
0.55 0.75	1.1 1.5	1.5	1.5 2.2	2.2 3	2.5...4	78	GV2RT08
1.1	2.2	2.2 3	3	4	4...6.3	138	GV2RT10
1.5 2.2	3 4	4	4 5.5	5.5 7.5	6...10	200	GV2RT14
2.2 3	5.5	5.5 7.5	7.5	9 11	9...14	280	GV2RT16
4	7.5	7.5 9	9	15	13...18	400	GV2RT20
5.5	9 11	11	11	18.5	17...23	400	GV2RT21

(1) The thermal trip setting must be within the range marked on the graduated knob.

## For primaries of 3-phase transformers

## Control by rocker lever

Standard power ratings					Setting range of thermal trips (2) A	Magnetic tripping current I <sub>d</sub> ± 20 % A	Reference
230/240 V	400/415 V	440 V	500 V	690 V			
kW	kW	kW	kW	kW			
–	–	–	–	–	0.25...0.40	8	GV2RT03
–	–	–	–	–	0.40...0.63	13	GV2RT04
–	–	0.63	0.63	1	0.63...1	22	GV2RT05
0.4	0.63	1	1	–	1...1.6	33	GV2RT06
0.63	1	–	1.6	1.6 2	1.6...2.5	51	GV2RT07
1	1.6 2	1.6 2	2 2.5	2.5	2.5...4	78	GV2RT08
1.6 2	2.5	2.5 4	4	4 5 6.3	4...6.3	138	GV2RT10
2.5	4 5	5	5 6.3	–	6...10	200	GV2RT14
4	6.3	6.3	–	10 12.5	9...14	280	GV2RT16
5 6.3	10	10	10 12.5	10	13...18	400	GV2RT20

## Accessory (3)

## Description

Padlockable external operator (IP 54)  
black handle, blue legend plate

Reference  
GV2AP03

(2) The thermal trip setting must be within the range marked on the graduated knob.

(3) Other accessories such as mounting, cabling and marking accessories are identical to those used for GV2 ME motor circuit breakers, see page B6/23.



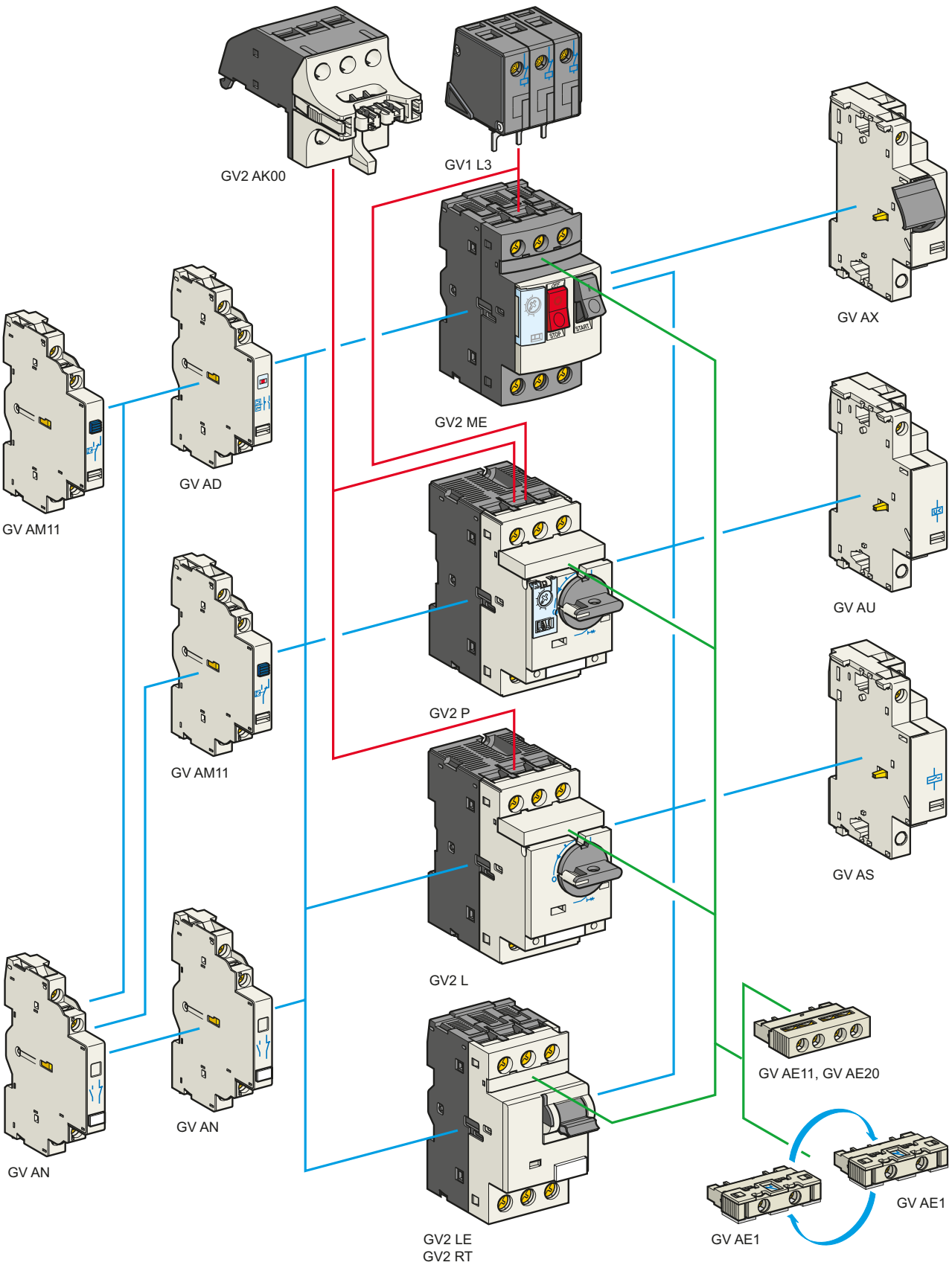

## TeSys protection components

Thermal-magnetic and magnetic motor circuit breakers GV2  
with screw clamp connections

Add-on blocks and accessories

Contact blocks						
Description	Mounting	Maximum number	Type of contacts	Sold in lots of	Unit reference	
Instantaneous auxiliary contacts	Front <sup>(1)</sup>	1	N/O or N/C <sup>(2)</sup>	10	GVAE1	
			N/O + N/C	10	GVAE11	
			N/O + N/O	10	GVAE20	
	Side (LH)	2	N/O + N/C	1	GVAN11	
			N/O + N/O	1	GVAN20	
Fault signalling contact + instantaneous auxiliary contact	Side <sup>(3)</sup> (LH)	1	N/O (fault)	+ N/O	1	GVAD1010
				+ N/C	1	GVAD1001
			N/C (fault)	+ N/O	1	GVAD0110
				+ N/C	1	GVAD0101
Short-circuit signalling contact	Side (LH)	1	C/O common point	1	GVAM11	

Electric trips			
Mounting	Voltage		Reference
<b>Undervoltage or shunt trips <sup>(4)</sup></b>			
Side (1 block on RH side of circuit breaker)	24 V	50 Hz	GVA●025
		60 Hz	GVA●026
	48 V	50 Hz	GVA●055
		60 Hz	GVA●056
	100 V	50 Hz	GVA●107
	100...110 V	60 Hz	GVA●107
	110...115 V	50 Hz	GVA●115
		60 Hz	GVA●116
	120...127 V	50 Hz	GVA●125
	127 V	60 Hz	GVA●115
	200 V	50 Hz	GVA●207
	200...220 V	60 Hz	GVA●207
	220...240 V	50 Hz	GVA●225
		60 Hz	GVA●226
	380...400 V	50 Hz	GVA●385
		60 Hz	GVA●386
	415...440 V	50 Hz	GVA●415
	415 V	60 Hz	GVA●416
	440 V	60 Hz	GVA●385
480 V	60 Hz	GVA●415	
500 V	50 Hz	GVA●505	
600 V	60 Hz	GVA●505	

**Undervoltage trip, INRS (can only be mounted on GV2 ME)  
Safety device for dangerous machines conforming to INRS and VDE 0113**

Side (1 block on RH side of circuit breaker GV2 ME)	110...115 V	50 Hz	GVAX115
		60 Hz	GVAX116
	127 V	60 Hz	GVAX115
	220...240 V	50 Hz	GVAX225
		60 Hz	GVAX226
	380...400 V	50 Hz	GVAX385
		60 Hz	GVAX386
	415...440 V	50 Hz	GVAX415
	440 V	60 Hz	GVAX385

**Limiter blocks**

Description	Mounting	Maximum number	Reference
Visible isolation block <sup>(5)</sup>	Front <sup>(1)</sup>	1	GV2AK00 <sup>(6)</sup>
Limiters	At top (GV2ME and GV2P)	1	GV1L3
	Independent	1	LA9LB920

- (1) Mounting of a GVAE contact block or a GV2AK00 visible isolation block on GV2P and GV2L.
- (2) Choice of N/C or N/O contact operation, depending on which way round the reversible block is mounted.
- (3) The GVAD is always mounted next to the circuit breaker.
- (4) To order an undervoltage trip: replace the dot (●) in the reference with a U, example: GVAU025.  
To order a shunt trip: replace the dot (●) in the reference with an S, example: GVAS025.
- (5) Visible isolation of the 3 poles upstream of circuit breaker GV2P and GV2L.
- (6) Ie Max = 32 A.

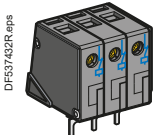

GV1L3

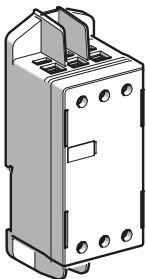

LA9LB920

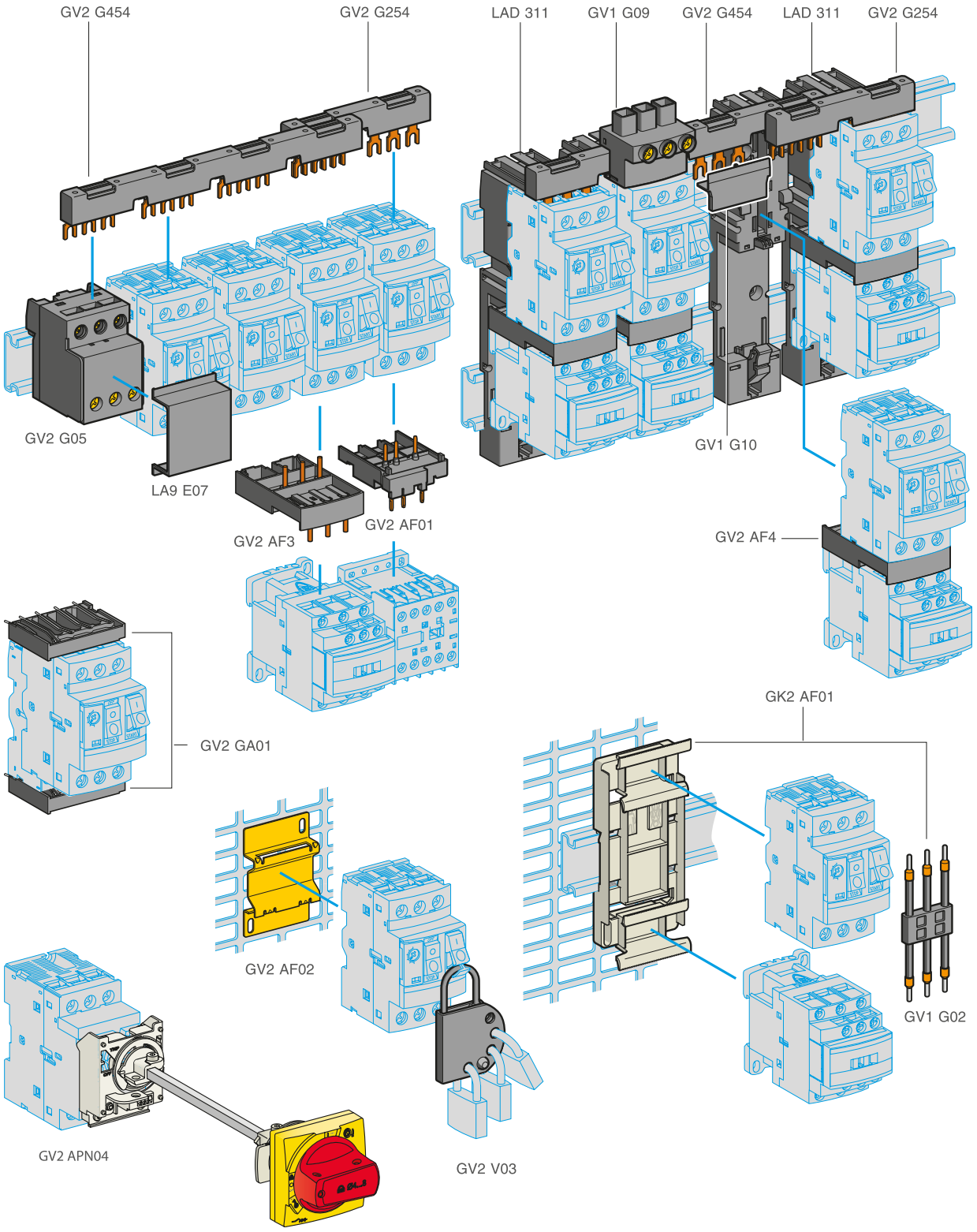

Circuit breakers

## TeSys protection components

Thermal-magnetic and magnetic motor circuit breakers GV2  
with screw clamp connections

Accessories

Accessories			
Description	Application	Sold in lots of	Unit reference
<b>Adapter plates</b>	For mounting a GV2 by screw fixing	10	<b>GV2AF02</b>
	For mounting a GV2ME and contactor LC1D09...D38 with front faces aligned	1	<b>LAD311</b>
<b>Height compensation plate</b>	7.5 mm to align GV2ME-GV2LE and GV2P-GV2L and allow the use of a common GV2G●●● busbar	10	<b>GV1F03</b>
<b>Combination blocks</b>	Between GV2 and contactor LC1K or LP1K	10	<b>GV2AF01</b>
	Between GV2 and contactor LC1D09...D38	10	<b>GV2AF3</b>
	Between GV2 mounted on LAD311 and contactor LC1D09...D38	10	<b>GV2AF4</b>
<b>Motor starter adapter plate</b>	With 3-pole connection for mounting a GV2 and a contactor LC1D09...D25	1	<b>GK2AF01</b>

Description	Application	Pitch	Reference
		mm	
<b>Sets of 3-pole Ie = 63 A busbars</b>	2 tap-offs	45	<b>GV2G245</b>
		54	<b>GV2G254</b>
		72	<b>GV2G272</b>
	3 tap-offs	45	<b>GV2G345</b>
		54	<b>GV2G354</b>
	4 tap-offs	45	<b>GV2G445</b>
		54	<b>GV2G454</b>
		72	<b>GV2G472</b>
	5 tap-offs	54	<b>GV2G554</b>

Description	Ie	Application	Sold in lots of	Unit reference
	A			
<b>Protective end cover</b>	-	For unused busbar outlets	5	<b>GV1G10</b>
<b>Terminal block</b> for supply to one or more GV2 G busbar sets	63	Connection from the top	1	<b>GV1G09</b>
	63	Can be fitted with current limiter GV1 L3 (GV2ME and GV2P)	1	<b>GV2G05</b>
<b>Cover for terminal block</b>	-	For mounting in modular panels	10	<b>LA9E07</b>
<b>Flexible 3-pole connection</b> for connecting a GV2 to a contactor LC1-D09...D25	25	Centre distance between mounting rails: 100...120 mm	10	<b>GV1G02</b>
<b>Set of connections</b> upstream/downstream	16	For connecting GV2 ME to a printed circuit board	10	<b>GV2GA01</b>
<b>"Large Spacing" adapter</b> UL 60947-4-1 type E	-	For GV2 P●● (except 32 A)	1	<b>GV2GH7</b>
<b>Clip-in marker holders</b> (supplied with each circuit breaker)	-	For GV2P, GV2L, GV2LE and GV2RT (8 x 22 mm)	100	<b>LA9D92</b>

PB 119241.eps



GV1 G09

Circuit  
breakers

## TeSys protection components

Thermal-magnetic and magnetic motor circuit breakers GV2 with screw clamp connections

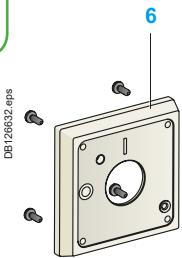
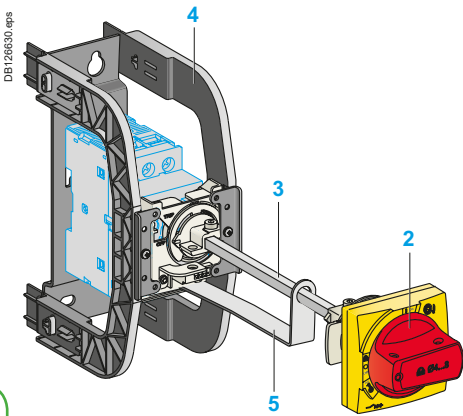
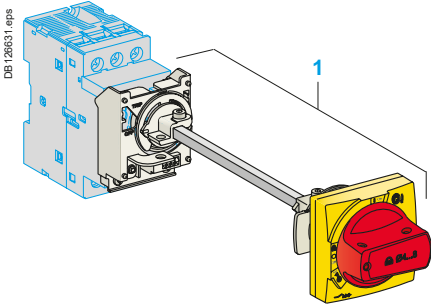

Circuit breakers

### Extended Rotary Handle

Allows a circuit breaker or a starter-controller installed in back of an enclosure to be operated from the front of the enclosure.

A rotary handle can be black or red/yellow, IP54 or IP65. It includes a function for locking the circuit breaker or the starter in the O (Off) for red/yellow handle, in the O (Off) or I (On) for black handle, by means of up to 3 padlocks with a shank diameter of 4 to 8 mm. The extended shaft must be adjusted to use in different size enclosures. The IP54 rotary handle is fixed with a nut (Ø22) to make easier the assembling. The new Laser Square tool brings the accuracy to align the circuit breaker and the rotary handle.

### Padlockable external operators for GV2P and GV2L

#### Description

- 1 Kit handle + mounting system
- 2 Universal handle
- 3 Shaft
- 4 Bracket
- 5 Shaft support plate for deep enclosure
- 6 Retrofit accessory
- 7 Laser Square accessory

#### Kit handle + mounting system

Description	Item	Reference
For GV2P/L	Black handle, front plate, with trip status, IP 54	1 GV2APN01
	Red handle, front plate, with trip status, IP 54	1 GV2APN02
	Black handle, front plate, without trip status, IP 65	1 GV2APN03
	Red handle, front plate, without trip status, IP 65	1 GV2APN04
For GV2LE	Padlocking in "On" and "Off" position	- GV2AP03
	Black handle, blue front plate, IP 54	

#### Universal handle

For GV2P/L	Black handle, with trip status, IP54	2 GVAPB54
	Red handle, with trip status, IP54	2 GVAPR54
	Red handle, without trip status, IP65	2 GVAPR65
	Black handle, without trip status, IP 65	2 GVAPB65

#### Shaft

For GV2P/L	L = 315 mm	3 GVAPA1
------------	------------	----------

#### Bracket

For GV2P/L		4 GVAPH02
------------	--	-----------

#### Shaft support plate for deep enclosure

For GV2P/L	Depth ≥ 250 mm	5 GVAPK11
------------	----------------	-----------

#### Retrofit accessory

For GV2P/L		6 GVAPP1
------------	--	----------

#### Laser Square accessory

For GV2P/L		7 GVAPL01
------------	--	-----------

#### Sticker

Warning label	For	Sold in lots of	Reference
	For French	10	- GVAPSFR
	For English	10	- GVAPSEN
	For German	10	- GVAPSD
	For Spanish	10	- GVAPSES
	For Chinese	10	- GVAPSCN
	For Portuguese	10	- GVAPSPT
	For Russian	10	- GVAPSRU
	For Italian	10	- GVAPSIT

### Padlocking device

Description	Reference	
For all GV2 device	For use with up to 4 padlocks, Ø6 mm shank max. (padlocks not included)	GV2V03



# TeSys GV3

11 to 45 kW



Circuit  
breakers

## TeSys protection components

### Magnetic motor circuit breakers GV3L

DF526146.fr



GV3L65

#### Motor circuit breakers from 0.09 to 45 kW

##### GV3L: control by rotary knob, connection by EverLink® BTR screw connectors

Standard power ratings of 3-phase motors 50/60 Hz in category AC-3									Magnetic protection rating	Tripping current I <sub>d</sub> ± 20 %	Use in association with thermal overload relay (class 10 A)	Reference
400/415 V			500 V			690 V						
P	I <sub>cu</sub>	I <sub>cs</sub> <sup>(1)</sup>	P	I <sub>cu</sub>	I <sub>cs</sub> <sup>(1)</sup>	P	I <sub>cu</sub>	I <sub>cs</sub> <sup>(1)</sup>				
kW	kA		kW	kA		kW	kA		A	A		
11	100	100	15	12	50	18.5	6	50	25	350	LRD 325	<b>GV3L25</b>
15	100	100	18.5	12	50	22	6	50	32	448	LRD 332	<b>GV3L32</b>
18.5	50	100	22	12	50	37	6	50	40	560	LRD 340	<b>GV3L40</b>
22	50	100	30	12	50	45	6	50	50	700	LRD 350	<b>GV3L50</b>
30	50	100	37	12	50	55	6	50	65	910	LRD 365	<b>GV3L65</b>
37	50	60	45	12	50	55	6	50	73	1120	LRD 380	<b>GV3L73</b>
45	50	60	45	12	50	55	6	50	80	1100	LRD 380	<b>GV3L80</b> <sup>(2)</sup>

##### Connection by EverLink® BTR screw connectors, for assembly with a contactor

To assemble a **GV3L25** to **L73** circuit breaker with an **LC1D40A** to **D80A** contactor, it is possible to use the circuit breaker supplied without downstream EverLink® power terminal block. To order this product, add the digit **1** to the end of the references selected above. Example: **GV3L73** becomes **GV3L731**. Do not use direct mounting between **GV3L80** and **LC1D80A** because of potential overheating, use cable link.

##### Connection by lugs

To order these circuit breakers with connection by lugs, add the digit **6** to the end of reference selected above. Example: **GV3L32** becomes **GV3L326**.

<sup>(1)</sup> As % of I<sub>cu</sub>. Associated current limiter or fuses, where required.

<sup>(2)</sup> 750 A Lock Rotor Current max.

★ > 100 kA.

# References - TeSys GV3 - 11 to 45 kW

## TeSys protection components

### Thermal-magnetic motor circuit breakers GV3P

DF526140.fr



GV3P651

PB116862.fr



GV3P80

#### Motor circuit breakers up to 45 kW / 400 V

Standard power ratings of 3-phase motors  
50/60 Hz in category AC-3

400/415 V									500 V			690 V			Setting range of thermal trips <sup>(2)</sup>	Magnetic tripping current Id ± 20 %	Reference
P	Icu	Ics <sup>(1)</sup>	P	Icu	Ics <sup>(1)</sup>	P	Icu	Ics <sup>(1)</sup>	P	Icu	Ics <sup>(1)</sup>						
kW	kA	%	kW	kA	%	kW	kA	%	A	A							
<b>GV3P: control by rotary knob</b>																	
Connection by EverLink® BTR screw connectors <sup>(3)</sup>																	
5.5	100	100	7.5	12	50	11	6	50	9...13	182						GV3P13	
7.5	100	100	9	12	50	15	6	50	12...18	252						GV3P18	
11	100	100	15	12	50	18.5	6	50	17...25	350						GV3P25	
15	100	100	18.5	12	50	22	6	50	23...32	448						GV3P32	
18.5	50	100	22	12	50	37	6	50	30...40	560						GV3P40	
22	50	100	30	12	50	45	6	50	37...50	700						GV3P50	
30	50	100	45	12	50	55	6	50	48...65	910						GV3P65	
37	50	60	45	12	50	55	6	50	62...73	1120						GV3P73	
45	50	60	45	12	50	55	6	50	70...80	1120						GV3P80 <sup>(4)</sup>	

Connection by EverLink® BTR screw connectors, for assembly with a contactor

To assemble a **GV3P13** to **P73** circuit breaker with an **LC1D40A** to **D73A** contactor, it is possible to use the circuit breaker supplied without downstream EverLink® power terminal block. To order this product, add the digit **1** to the end of the references selected above. Example: **GV3P73** becomes **GV3P731**. Do not use direct mounting between **GV3P80** and **LC1D80A** because of potential overheating, use cable link.

Connection by lugs

To order thermal magnetic circuit breakers with connection by lugs, add the digit **6** to the end of reference selected above. Example: **GV3P18** becomes **GV3P186**.

#### Motor circuit breakers up to 40 HP / 460 V, UL 60947-4-1 type E

GV3P13<sup>(5)</sup> to GV3P65<sup>(5)</sup>

To obtain a motor-circuit breaker **GV3P**, UL 60947-4-1 type E, use the following with the circuit breaker:

- a "Large Spacing" cover **GV3G66**,
- a short-circuit signalling contact **GVAM11**.

#### Motor circuit breakers from 7.5 to 50 HP / 460 V, with screw clamp terminals

GV3P with rotary handle

Thermal setting (A)	Maximum Horsepower ratings <sup>(6)</sup>						Reference
	Single-Phase		Three-Phase				
	115 V	230 V	200 V	230 V	460 V	575 V	
9...13	1/2	1.5	3	3	7.5	10	GV3P13
12...18	3/4	2	3	5	7.5	10	GV3P18
17...25	1.5	3	5	7.5	15	20	GV3P25
23...32	2	3	7.5	7.5	20	25	GV3P32
30...40	3	5	10	10	25	30	GV3P40
37...50	3	7.5	10	10	30	40	GV3P50
48...65	3	10	15	15	40	50	GV3P65
62...73	5	15	20	25	50	60	GV3P73

GV3P13 to GV3P65 - with connection by lugs<sup>(6)</sup>

To obtain a motor-circuit breaker **GV3P**, UL 60947-4-1 type E, with connection by lugs, add the digit **6** to the end of reference selected above and use the following with the circuit breaker:

- two IP 20 covers **LAD96570**,
- a short-circuit signalling contact **GVAM11**.

(1) As % of Icu.

(2) The thermal trip setting must be within the range marked on the graduated knob.

(3) BTR screws: hexagon socket head. Require use of an insulated Allen key, in compliance with local wiring regulations.

(4) 750 A Lock Rotor Current max.

(5) Accessories: see page B6/30.

(6) 3P FLA corresponding values: see page A6/58.

Circuit breakers

Circuit breakers

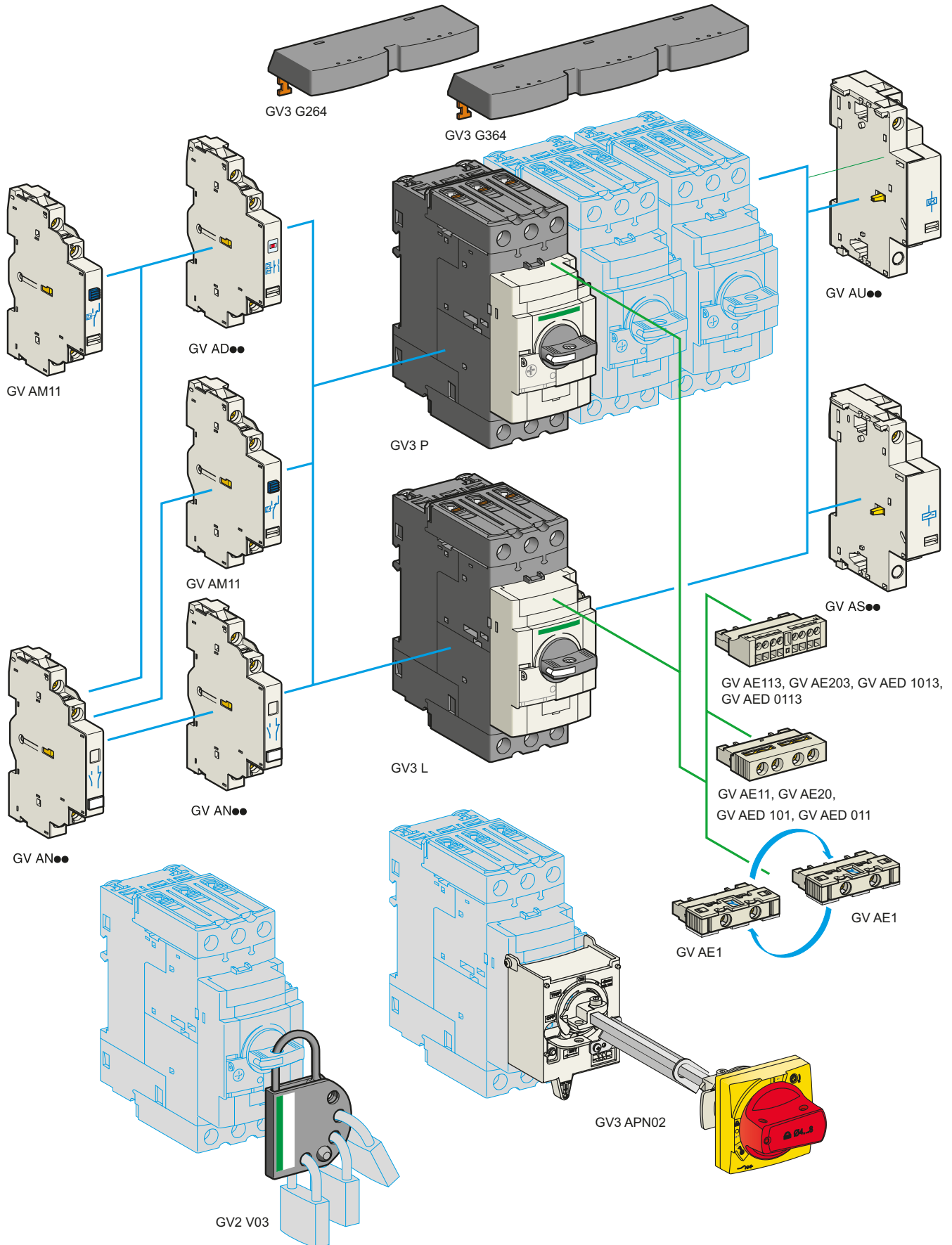

## TeSys protection components

Thermal-magnetic motor circuit breakers GV3P and GV3L

Add-on blocks and accessories

DF537424.eps

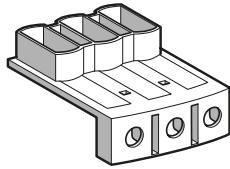

GV3G66

Contact blocks					
Description	Mounting	Maximum number	Type of contacts	Sold in lots of	Unit reference
Instantaneous auxiliary contacts	Front	1	N/O or N/C <sup>(1)</sup>	10	GVAE1
			N/O + N/C	10	GVAE11 <sup>(2)</sup>
			N/O + N/O	10	GVAE20 <sup>(2)</sup>
	Side (LH)	2	N/O + N/C	1	GVAN11 <sup>(2)</sup>
			N/O + N/O	1	GVAN20 <sup>(2)</sup>
Fault signalling contact + instantaneous auxiliary contact	Front	1	N/O (fault) + N/O	1	GVAED101 <sup>(2)</sup>
			N/O (fault) + N/C	1	GVAED011 <sup>(2)</sup>
	Side <sup>(3)</sup> (LH)	1	N/O (fault) + N/O	1	GVAD1010
			+ N/C	1	GVAD1001
			N/C (fault) + N/O	1	GVAD0110
			+ N/C	1	GVAD0101
Short-circuit signalling contact	Side (LH)	1	C/O common point	1	GVAM11

Electric trips - undervoltage or shunt <sup>(4)</sup>			
Mounting	Voltage		Reference
Side (1 block on RH side of circuit breaker)	24 V	50 Hz	GVA●025
		60 Hz	GVA●026
	48 V	50 Hz	GVA●055
		60 Hz	GVA●056
	100	50 Hz	GVA●107
	100...110 V	60 Hz	GVA●107
	110...115 V	50 Hz	GVA●115
		60 Hz	GVA●116
	120...127 V	50 Hz	GVA●125
	127 V	60 Hz	GVA●115
	200 V	50 Hz	GVA●207
		60 Hz	GVA●207
	220...240 V	50 Hz	GVA●225
		60 Hz	GVA●226
	380...400 V	50 Hz	GVA●385
		60 Hz	GVA●386
	415...440 V	50 Hz	GVA●415
		60 Hz	GVA●416
	440 V	60 Hz	GVA●385
480 V	60 Hz	GVA●415	
500 V	50 Hz	GVA●505	
600 V	60 Hz	GVA●505	

Accessories			
Description			Reference
Set of 3-pole busbars I <sub>e</sub> = 115 A Pitch: 64 mm	2 tap-off	GV3P●● and GV3L●●	GV3G264
	3 tap-off	GV3P●● and GV3L●●	GV3G364
Cover "Large Spacing" UL 60947-4-1 type E (Only one cover required on supply side)		GV3P●●	GV3G66

- (1) Choice of N/C or N/O contact operation, depending on which way round the reversible block is mounted.  
 (2) Contact blocks available in version with spring terminal connections. Add a figure 3 at the end of the references selected above.  
 Example: **GVAED101** becomes **GVAED1013**.  
 (3) The **GVAD●●** is always mounted next to the circuit breaker.  
 (4) To order an undervoltage trip: replace the dot (●) in the reference with a **U**, example: **GVAU025**.  
 To order a shunt trip: replace the dot (●) in the reference with an **S**, example: **GVAS025**.



Limited torque throwaway bits

Torque limiting breakaway bits		
Description	Sold in lots of	Reference
5 N.m Yellow	6	LV426992
9 N.m Green	6	LV426990

Circuit breakers

# TeSys protection components

## Thermal-magnetic motor circuit breakers GV3P and GV3L

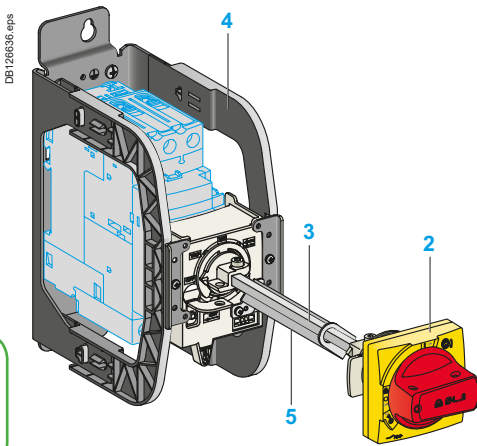
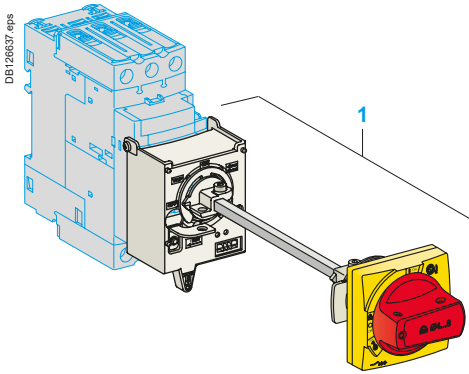

Circuit breakers

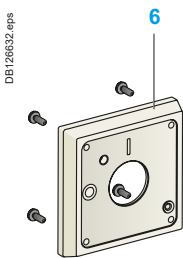

### Extended Rotary Handle

Allows a circuit breaker or a starter-controller installed in back of an enclosure to be operated from the front of the enclosure.

A rotary handle can be black or red/yellow, IP54 or IP65. It includes a function for locking the circuit breaker or the starter in the O (Off) or I (On) position (depending of the type of rotary handle) by means of up to 3 padlocks with a shank diameter of 4 to 8 mm. The extended shaft must be adjusted to use in different size enclosures. The IP54 rotary handle is fixed with a nut (Ø22) to make easier the assembling. The new Laser Square tool brings the accuracy to align the circuit breaker and the rotary handle.

### Padlockable external operators for GV3 and GV3L

#### Description

- 1 Kit handle + mounting system
- 2 Universal handle
- 3 Shaft
- 4 Bracket
- 5 Shaft support plate for deep enclosure
- 6 Retrofit accessory
- 7 Laser Square accessory

#### Kit handle + mounting system

Description	Item	Reference
For GV3P/L Black handle, front plate, with trip status, IP 54	1	GV3APN01
Red handle, front plate, with trip status, IP 54	1	GV3APN02
Black handle, front plate, without trip status, IP65	1	GV3APN03
Red handle, front plate, without trip status, IP 65	1	GV3APN04

#### Universal handle

For GV3P/L Black handle, with trip status, IP54	2	GVAPB54
Red handle, with trip status, IP54	2	GVAPR54
Black handle, without trip status, IP65	2	GVAPB65
Red handle, without trip status IP65	2	GVAPR65

#### Shaft

For GV3P/L L = 315 mm	3	GVAPA1
-----------------------	---	--------

#### Bracket

For GV3P/L	4	GVAPH03
------------	---	---------

#### Shaft support plate for deep enclosure

For GV3P/L Depth ≥ 300 mm	5	GVAPK12
---------------------------	---	---------

#### Retrofit accessory

For GV3P/L	6	GVAPP1
------------	---	--------

#### Laser Square accessory

For GV3P/L	7	GVAPL01
------------	---	---------

Sticker	Sold in lots of		
Warning label	For French	10	- GVAPSF
	For English	10	- GVAPSE
	For German	10	- GVAPSD
	For Spanish	10	- GVAPSE
	For Chinese	10	- GVAPSC
	For Portuguese	10	- GVAPSP
	For Russian	10	- GVAPSR
	For Italian	10	- GVAPSI

# TeSys GV4

0.25 to 55 kW - 1/2 to 60 HP



Circuit  
breakers

# TeSys protection components

## TeSys GV4 overview

### Protection

TeSys GV4 motor circuit breaker covers motor protection from 0.25 to 55 kW at 415 V AC (from 0.8 to 115 A) in one frame and is available in 3 breaking capacities: 25, 50 and 100 kA at 415 V AC IEC (15, 35, 65 kA at 480 V UL).

TeSys GV4 is available with 3 types of protection:

- Magnetic GV4L: to be used with an overload relay or a drive
- Thermal magnetic GV4P: electronic protection with wide range setting, dual class (10 & 20)
- Multifunction motor protection GV4PEM: GV4P with adjustable advanced protections and possibility to have a side module SDx for alarming and motor functional fault differentiation.

### Power connections

TeSys GV4 comes in standard with 2-holes EverLink™ power connectors with creep <sup>(1)</sup> compensation for bare copper cables. This Schneider Electric patented technique makes it possible to achieve accurate and durable tightening torque in order to avoid cable creep.

Products may be delivered with connectors for bars or cables with compression lugs (except GV4PB).

Whatever, the connectors are field interchangeable and can be removed for the installation of one of both.

And to tight at the right torque power connections particularly in the field, torque limiting breakaway bits may be used.

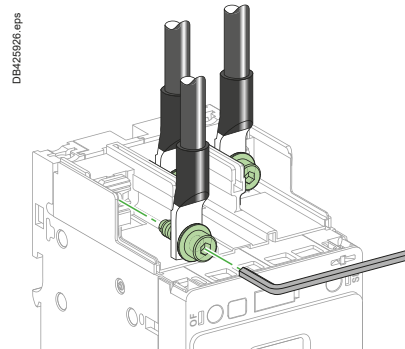
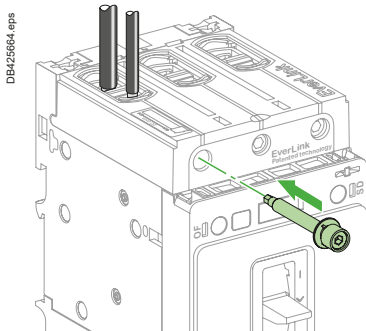

### Mounting

TeSys GV4 can be mounted on a backplate or on a DIN rail (35 or 75 mm).

### Handle

TeSys GV4 can be ordered with a toggle or a direct rotary handle (except for GV4P Multifunction).

It is also possible to equip a toggle one with a direct rotary handle, or a front extended one, or a side one.

### Auxiliaries

TeSys GV4 circuit breakers can be equipped with an open/close (OF) contact and a trip indication (SD) contact. These contacts are common point changeover type, with a normally open (NO) and a normally closed (NC) contact.

TeSys GV4 may be equipped too with an MN (undervoltage release) or MX (shunt trip) coil.

GV4P Multifunction circuit breakers can be equipped with 1 or 2 SDx module(s) in order to have alarming and motor functional fault differentiation (SDx - See page B6/44)

Auxiliaries have spring connections for cables up to 1.5 mm<sup>2</sup>.

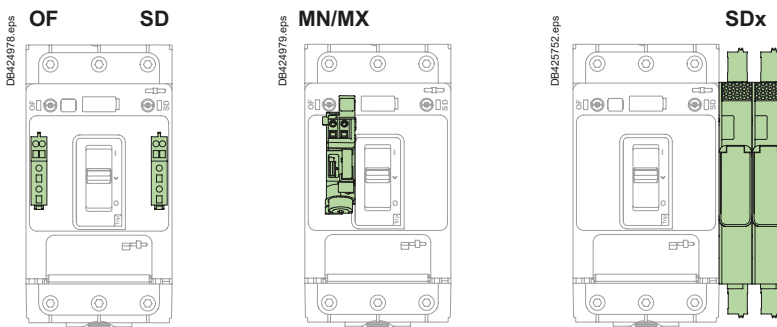

<sup>(1)</sup> Creep: normal crushing phenomenon of conductors, that is accentuated over time.



## TeSys protection components

### TeSys GV4 overview

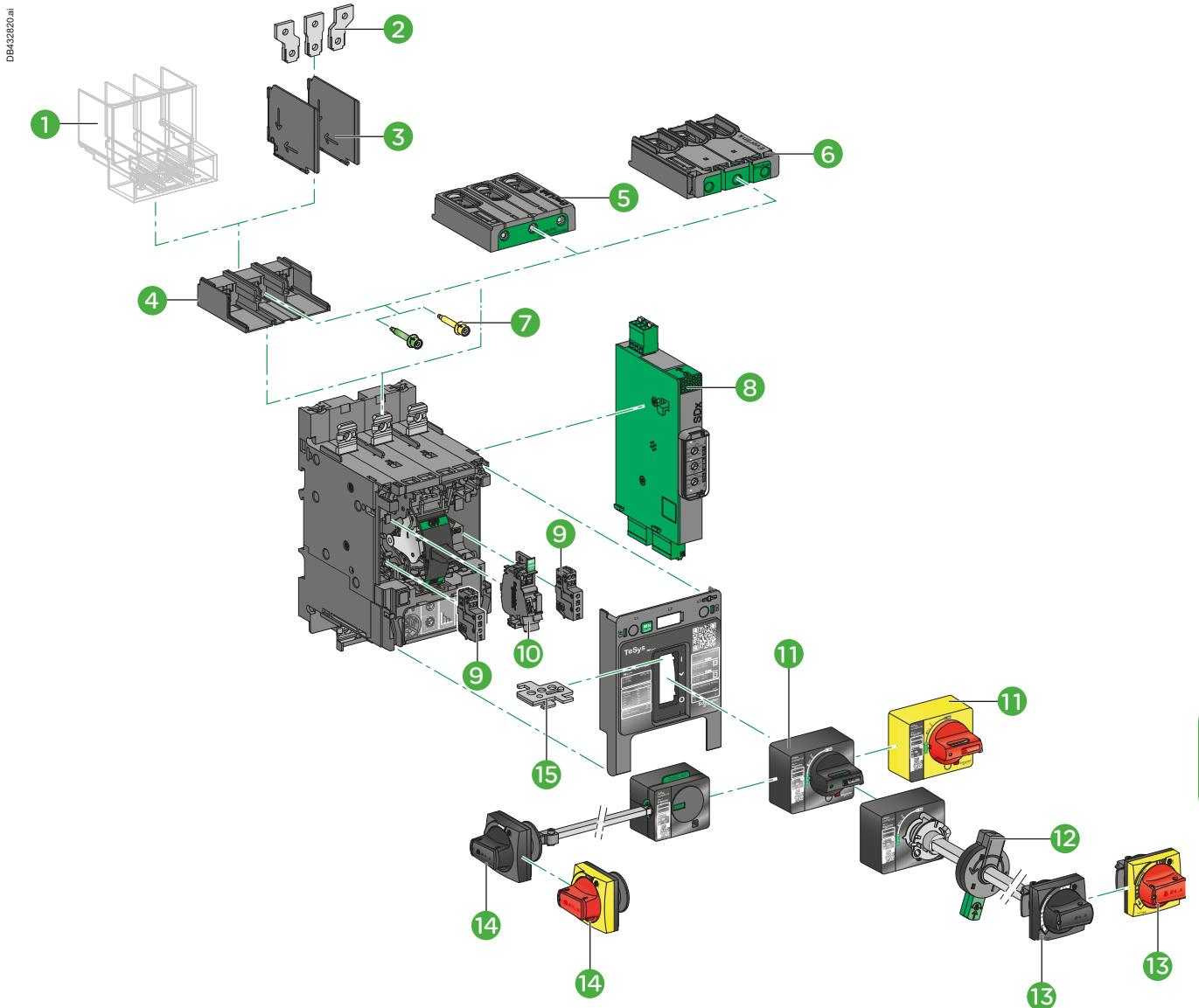

- 1 Long terminal shield **LAD96590**
- 2 Terminal spreaders **LV426940**
- 3 Interphases barriers **LV426920**
- 4 Crimp lug connector **GV4LUG**
- 5 EverLink® connector **LAD96595**
- 6 Everlink® terminals and large spacing cover **GV4G66 + LAD96595**
- 7 Torque limiting breakaway bits **LV42699●**
- 8 SDx alarming/fault differentiation module **GV4ADM1111** (only with GV4PEM)
- 9 Auxiliary contact block for OF or SD function **GV4AE11**
- 10 - MN undervoltage release **GV4AU●●**  
- MX shunt trip **GV4AS●●**
- 11 Direct mounting black or red on yellow bezel rotary handle **GV4ADN01/ GV4ADN02**
- 12 Open door shaft operator (for front extended rotary handle) **LV426937**
- 13 Front extended rotary handle kit with red handle on yellow bezel or black handle **GV4APN01/ GV4APN02 /GV4APN04**
- 14 Side rotary handle kit with red handle on yellow bezel or black handle **LV426935/LV426936**.
- 15 Toggle locking device **29370**

## References - TeSys GV4 - 0.25 to 55 kW

### TeSys protection components

#### Magnetic motor circuit breakers GV4L and GV4LE



GV4L



GV4LE

#### Protection

Setting is made using dial.

#### Trip class (class)

GV4 L can be used with class 5, 10 or 20 relay.

#### Short circuit protection (Ii)

Protection with an adjustable pick-up  $I_i = 6$  to  $14 I_n$ . Settings are made in amperes.

#### Standards and certifications

IEC/EN 60947-1, IEC/EN 60947-2, CCC, EAC.

## TeSys protection components

### Magnetic motor circuit breakers GV4L and GV4LE

Magnetic motor circuit breakers from 0.25 to 55 kW										In A	Magnetic setting range (ii) A	Use in association with overload relay Class 10 or 20	Reference with EverLink terminals	
Standard power ratings of 3-phase motors - 50 / 60 Hz									with toggle				with rotary handle	
400/415 V			500 V			690 V								
P kW	I <sub>cu</sub> kA	I <sub>cs</sub> <sup>(1)</sup> %	P kW	I <sub>cu</sub> kA	I <sub>cs</sub> <sup>(1)</sup> %	P kW	I <sub>cu</sub> kA	I <sub>cs</sub> <sup>(1)</sup> %	A					
0.25... 0.75	25	100	0.37... 1.1	10	100	0.55... 1.5	-	-	2	12... 28	LRD05 (0.63... 1A) LRD06 (1... 1.6A) LRD07 (1.6... 2.5A)	-	-	
	50	100		25	100		8	25				GV4LE02N	GV4L02N	
	100	100		30	100		10	25				GV4LE02S	-	
0.55... 1.5	25	100	0.75... 1.5	10	100	1.1... 2.2	-	-	3,5	21... 49	LRD07 (1.6... 2.5A) LRD08 (2.5... 4A)	-	-	
	50	100		25	100		8	25				GV4LE03N	GV4L03N	
	100	100		30	100		10	25				GV4LE03S	-	
1.5... 3	25	100	2.2... 4	10	100	3... 7.5	-	-	7	42... 98	LRD08 (2.5... 4A) LRD10 (4... 6A)	-	-	
	50	100		25	100		8	25				GV4LE07N	GV4L07N	
	100	100		30	100		10	25				GV4LE07S	-	
3... 5.5	25	100	3... 7.5	10	100	5.5... 11	-	-	12,5	75... 175	LRD12 (5.5... 8A) LRD14 (7... 10A) LRD313 (9... 13A)	-	-	
	50	100		25	100		8	25				GV4LE12N	GV4L12N	
	100	100		30	100		10	25				GV4LE12S	-	
5.5... 11	25	100	7.5... 15	10	100	7.5... 18.5	-	-	25	150... 350	LRD318 (12... 18A) LRD325 (17... 25A)	GV4LE25B	GV4L25B	
	50	100		25	100		8	25				GV4LE25N	GV4L25N	
	100	100		30	100		10	25				GV4LE25S	-	
11... 22	25	100	15... 30	10	100	18.5... 45	-	-	50	300... 700	LRD332 (23... 32A) LRD340 (30... 40A) LRD350 (37... 50A)	GV4LE50B	GV4L50B	
	50	100		25	100		8	25				GV4LE50N	GV4L50N	
	100	100		30	100		10	25				GV4LE50S	-	
18.5... 37	25	100	22... 55	10	100	30... 55	-	-	80	480... 1120	LRD365 (48... 65A) LRD3363 (63... 80A)	GV4LE80B	GV4L80B	
	50	100		25	100		8	25				GV4LE80N	GV4L80N	
	100	100		30	100		10	25				GV4LE80S	GV4L80S	
30... 55	25	100	30... 75	10	100	45... 90	-	-	115	690... 1610	LR9D5567 (60... 100A) LR9F5367 (60... 100A) LR9D5369 (90... 150A) LR9F5369 (90... 150A)	GV4LE115B	GV4L115B	
	50	100		25	100		8	25				GV4LE115N	GV4L115N	
	100	100		30	100		10	25				GV4LE115S	GV4L115S	

Circuit breakers

#### Connection by lugs

To order circuit breakers with connection by lugs, add the digit **6** to the end of reference selected above. Example: **GV4LE02N** becomes **GV4LE02N6**.

(1) As % of I<sub>cu</sub>.

## TeSys protection components

### Thermal-magnetic motor circuit breakers GV4P and GV4PE

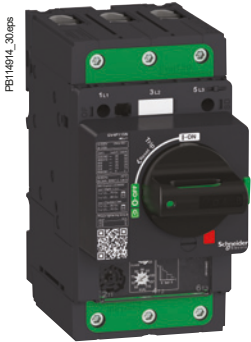

GV4P



GV4PE

Circuit breakers

#### Protection

Settings are made using dials.

##### Overload or thermal protection ( $I_r$ )

Inverse-time thermal protection against overloads with adjustable pick-up  $I_r$ .

Wide range setting made in amperes.

The tripping curve for the thermal protection, which indicates the time delay  $t_r$  before tripping, is defined by the selected trip class.

##### Trip class (class)

The class is selected as a function of the normal motor starting time.

- Class 10: starting time less than 10 s.

- Class 20: starting time less than 20 s.

For a given class, it is necessary to check that all motor-feeder components are sized to carry the  $7.2 I_r$  starting current without excessive temperature rise during the time corresponding to the class.

##### Short time delay protection ( $I_{sd}$ )

Short time delay protection (around 100 ms) to let through motor starting currents, but to protect cables and motor starter devices and allow not to oversize them (particularly usefull for wide range settings circuit breakers).

Fixed pick-up  $I_{sd} = 13 I_r$ .

##### Short-circuit protection ( $I_i$ )

Instantaneous protection with non-adjustable pick-up  $I_i = 17 I_n$ .

##### Phase unbalance or phase loss ( $I_{unbal}$ , $I_{tunbal}$ )

This function opens the circuit breaker if a phase unbalance occurs:

- that is greater than the 30 % of  $I_{rms}$  (fixed pick-up):  **$I_{unbal}$**

- following the non-adjustable time delay ( **$I_{tunbal}$** ) equal to:

- 0.7 s during starting

- 4 s during normal operation.

Phase loss is an extreme case of phase unbalance and leads to tripping under the same conditions.

##### Ground-fault protection ( $I_g$ , $t_g$ )

Residual type ground-fault protection:

- fixed pick-up  $I_g = I_n$

- fixed time delay  $t_g = 0.1$  s.

#### Indications

##### Front indications

- Green "Ready" LED: flashes slowly when the circuit breaker is ready to trip in the event of an abnormal deviation in engine operating conditions.

- Red alarm LED: goes ON when the thermal image of the motor is greater than 95 % of the permissible temperature rise.

##### Standards and certifications

IEC/EN 60947-1, IEC/EN 60947-2, IEC/EN 60947-4-1, UL 60497-4-1, CSA 22.2 n° 60497-4-1, CCC, EAC, CSA (cCSAus).

## TeSys protection components

### Thermal-magnetic motor circuit breakers GV4P and GV4PE

Thermal magnetic motor circuit breakers from 0.25 to 55 kW											
Standard power ratings of 3-phase motors - 50 / 60 Hz in category AC-3									Thermal setting range (I <sub>r</sub> )	Reference with EverLink terminals	
400/415 V			500 V			690 V				A	with toggle
P kW	I <sub>cu</sub> kA	I <sub>cs</sub> (%)	P kW	I <sub>cu</sub> kA	I <sub>cs</sub> (%)	P kW	I <sub>cu</sub> kA	I <sub>cs</sub> (%)			
0.25... 0.75	25	100	0.37... 1.1	10	100	0.55... 1.5	-	-	0.8... 2	-	-
	50	100		25	100		8	25		GV4PE02N	GV4P02N
	100	100		30	100		10	25		GV4PE02S	-
0.55... 1.5	25	100	0.75... 1.5	10	100	1.1... 2.2	-	-	1.4... 3.5	-	-
	50	100		25	100		8	25		GV4PE03N	GV4P03N
	100	100		30	100		10	25		GV4PE03S	-
1.5... 3	25	100	2.2... 4	10	100	3... 7.5	-	-	2.9... 7	-	-
	50	100		25	100		8	25		GV4PE07N	GV4P07N
	100	100		30	100		10	25		GV4PE07S	-
3... 5.5	25	100	3... 7.5	10	100	5.5... 11	-	-	5... 12.5	-	-
	50	100		25	100		8	25		GV4PE12N	GV4P12N
	100	100		30	100		10	25		GV4PE12S	-
5.5... 11	25	100	7.5... 15	10	100	7.5... 18.5	-	-	10... 25	GV4PE25B	GV4P25B
	50	100		25	100		8	25		GV4PE25N	GV4P25N
	100	100		30	100		10	25		GV4PE25S	-
11... 22	25	100	15... 30	10	100	18.5... 45	-	-	20... 50	GV4PE50B	GV4P50B
	50	100		25	100		8	25		GV4PE50N	GV4P50N
	100	100		30	100		10	25		GV4PE50S	-
22... 37	25	100	30... 55	10	100	37... 55	-	-	40... 80	GV4PE80B	GV4P80B
	50	100		25	100		8	25		GV4PE80N	GV4P80N
	100	100		30	100		10	25		GV4PE80S	GV4P80S
37... 55	25	100	45... 75	10	100	75... 90	-	-	65... 115	GV4PE115B	GV4P115B
	50	100		25	100		8	25		GV4PE115N	GV4P115N
	100	100		30	100		10	25		GV4PE115S	GV4P115S

Thermal magnetic motor circuit breakers from 3/4 to 75 HP / 480 V														
Single-Phase 120 V				3-Phase								Rating	Reference with EverLink terminals	
Power HP	FLA A	Power Hp	FLA A	Power Hp	FLA A	Power Hp	FLA A	Power Hp	FLA A	Power Hp	FLA A		A	with toggle
-	-	1/10	1.5	-	-	-	-	3/4	1.6	1	1.7	2	-	-
													GV4PE02N	GV4P02N
													GV4PE02S	-
1/10	3	1/4	2.9	1/2	2.4	3/4	3.2	2	3.4	2	2.7	3.5	-	-
													GV4PE03N	GV4P03N
													GV4PE03S	-
1/4	5.8	3/4	6.9	1-1/2	6.6	2	6.8	3	4.8	5	6.1	7	-	-
													GV4PE07N	GV4P07N
													GV4PE07S	-
1/2	9.8	1-1/2	10	3	10.6	3	9.6	7-1/2	11	10	11	12.5	-	-
													GV4PE12N	GV4P12N
													GV4PE12S	-
1-1/2	20	3	17	5	16.7	7-1/2	22	15	21	20	22	25	GV4PE25B	GV4P25B
													GV4PE25N	GV4P25N
													GV4PE25S	-
3	34	7-1/2	40	10	30.8	15	42	30	40	40	41	50	GV4PE50B	GV4P50B
													GV4PE50N	GV4P50N
													GV4PE50S	-
7-1/2	80	15	68	25	74.8	30	80	60	77	75	77	80	GV4PE80B	GV4P80B
													GV4PE80N	GV4P80N
													GV4PE80S	GV4P80S
10	100	20	88	30	88	40	104	75	96	100	99	115	GV4PE115B	GV4P115B
													GV4PE115N	GV4P115N
													GV4PE115S	GV4P115S

#### Connection by lugs

To order circuit breakers with connection by lugs, add the digit **6** to the end of reference selected above. Example: **GV4PE02N** becomes **GV4PE02N6**.

(1) As % of I<sub>cu</sub>.

## TeSys protection components

### Thermal-magnetic motor circuit breakers GV4PEM

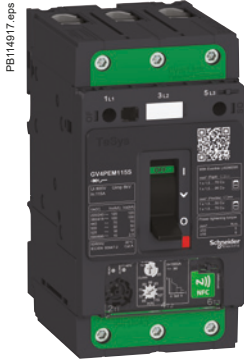

GV4PEM

PB114917.eps

Circuit breakers

#### Basic protection

Settings are made using dials.

##### Overloads or thermal protection (Ir)

Inverse-time thermal protection against overloads with adjustable pick-up  $I_r$ . Wide range setting made in amperes.

The tripping curve for the thermal protection, which indicates the time delay  $t_r$  before tripping, is defined by the selected trip class.

##### Trip class (class)

The class is selected as a function of the normal motor starting time.

- Class 10: starting time less than 10 s.
- Class 20: starting time less than 20 s.

For a given class, it is necessary to check that all motor-feeder components are sized to carry the  $7.2 I_r$  starting current without excessive temperature rise during the time corresponding to the class.

##### Short-circuit protection (Ii)

Instantaneous protection with non-adjustable pick-up  $I_i=17 I_n$ .

#### Advanced protection

Settings are made with an Android smartphone with dedicated application and using wireless NFC (Near Field Communication), or a computer with EcoStruxure Power Commission software and the configuration/maintenance tool kit ("Maintenance case" TRV00910).

The LV434206 pocket battery allows the GV4PEM controller to be powered for adjustments and tests when no internal source is available.

##### Short time delay protection (I<sub>sd</sub>)

Short time delay protection (around 100 ms) to let through motor starting currents, but to protect cables and motor starter devices and allow not to oversize them (particularly usefull for wide range settings circuit breakers).

Adjustable pick-up  $I_{sd} = 5...13 I_r$  (13 by default).

##### Phase unbalance or phase loss (I<sub>unbal</sub>, I<sub>tunbal</sub>)

This function opens the circuit breaker if a phase unbalance occurs:

- that is greater than the 10...40 % of  $I_{rms}$  (30% by default): **I<sub>unbal</sub>**
- following a time delay (**I<sub>tunbal</sub>**) equal to:
  - 0.7 s during starting (non adjustable)
  - 1...10 s during normal operation (4 s by default).

Phase loss is an extreme case of phase unbalance and leads to tripping under the same conditions.

##### Ground-fault protection (I<sub>g</sub>, t<sub>g</sub>)

Residual type ground-fault protection, with OFF position:

- adjustable pick-up **I<sub>g</sub>**:
  - 0.7...1 In for products with nominal current from 2 to 50 A
  - 0.4...1 In for products with nominal current from 80 to 115 A
- adjustable time delay **t<sub>g</sub>** 0.1...0.4 s.

##### Jam (I<sub>jam</sub>, t<sub>jam</sub>)

This function detects locking of the motor shaft caused by the load, with OFF position (OFF by default). During motor starting the function is disabled.

During normal operation, it causes tripping:

- above the **I<sub>jam</sub>** pick-up that can be fine-adjusted from 1.5 to 8 Ir
- in conjunction with the **t<sub>jam</sub>** time delay that can be adjusted from 1 to 30 s.

##### Long start (I<sub>long</sub>, t<sub>long</sub>)

This protection supplements thermal protection (class). It is used to optimize the protection according to the starting parameters, with OFF position (OFF by default).

It detects abnormal motor starting i.e. when the starting current remains too high or too low with respect to a pick-up value and a time delay.

It causes tripping:

- in relation with a **I<sub>long</sub>** pick-up that can be fine-adjusted from 1.5 to 8 Ir
- in conjunction with the **t<sub>long</sub>** time delay that can be adjusted from 1 to 200 s.

#### Indications

##### Front indications

- Green "Ready" LED: flashes slowly when the circuit breaker is ready to trip in the event of an abnormal deviation in engine operating conditions.
- Red alarm LED: goes ON when the thermal image of the motor is greater than 95 % of the permissible temperature rise.

##### Remote indications via SDx module

See description on page B6/44.

##### Standards and certifications

IEC/EN 60947-1, IEC/EN 60947-2, IEC/EN 60947-4-1, UL 60497-4-1, CSA 22.2 n° 60497-4-1, CCC, EAC, CSA (cCSAus).

## TeSys protection components

### Thermal-magnetic motor circuit breakers GV4PEM

Thermal magnetic motor circuit breakers from 0.25 to 55 kW										
Standard power ratings of 3-phase motors - 50 / 60 Hz in category AC-3									Thermal setting range (I <sub>r</sub> )	"Reference with EverLink terminals" with toggle
400/415 V			500 V			690 V				
P kW	I <sub>cu</sub> kA	I <sub>cs</sub> <sup>(1)</sup> %	P kW	I <sub>cu</sub> kA	I <sub>cs</sub> <sup>(1)</sup> %	P kW	I <sub>cu</sub> kA	I <sub>cs</sub> <sup>(1)</sup> %	A	
0.25... 0.75	25	100	0.37... 1.1	10	100	0.55... 1.5	-	-	0.8... 2	-
	50	100		25	100		8	25		GV4PEM02N
	100	100		30	100		10	25		GV4PEM02S
0.55... 1.5	25	100	0.75... 1.5	10	100	1.1... 2.2	-	-	1.4... 3.5	-
	50	100		25	100		8	25		GV4PEM03N
	100	100		30	100		10	25		GV4PEM03S
1.5... 3	25	100	2.2... 4	10	100	3... 7.5	-	-	2.9... 7	-
	50	100		25	100		8	25		GV4PEM07N
	100	100		30	100		10	25		GV4PEM07S
3... 5.5	25	100	3... 7.5	10	100	5.5... 11	-	-	5... 12.5	-
	50	100		25	100		8	25		GV4PEM12N
	100	100		30	100		10	25		GV4PEM12S
5.5... 11	25	100	7.5... 15	10	100	7.5... 18.5	-	-	10... 25	GV4PEM25B
	50	100		25	100		8	25		GV4PEM25N
	100	100		30	100		10	25		GV4PEM25S
11... 22	25	100	15... 30	10	100	18.5... 45	-	-	20... 50	GV4PEM50B
	50	100		25	100		8	25		GV4PEM50N
	100	100		30	100		10	25		GV4PEM50S
22... 37	25	100	30... 55	10	100	37... 55	-	-	40... 80	GV4PEM80B
	50	100		25	100		8	25		GV4PEM80N
	100	100		30	100		10	25		GV4PEM80S
37... 55	25	100	45... 75	10	100	75... 90	-	-	65... 115	GV4PEM115B
	50	100		25	100		8	25		GV4PEM115N
	100	100		30	100		10	25		

Circuit breakers

**Connection by lugs**  
 To order circuit breakers with connection by lugs, add the digit **6** to the end of reference selected above. Example: **GV4PE02N** becomes **GV4PE02N6**.

(1) As % of I<sub>cu</sub>.

## TeSys protection components

### Thermal-magnetic motor circuit breakers GV4PB

PB120622.eps



GV4PB

Circuit breakers

GV4PB is based on GV4PEM with specific tripping curve to follow UL489 SH supplement. It is designed with a large space connector in order to increase creepage and clearance distance.

#### Basic protection

Settings are made using dials.

##### Overloads or thermal protection (Ir)

Inverse-time thermal protection against overloads with adjustable pick-up Ir. Wide range setting made in amperes.

The tripping curve for the thermal protection, which indicates the time delay tr before tripping, is defined by the selected trip class.

##### Trip class (class)

The class is selected as a function of the normal motor starting time. It corresponds to the value of the tripping time delay for a current of 600 % of the rated tripping current according to UL489, SH supplement.

The rated tripping current is selected as 125 % of the dial value.

■ Class 10: starting time less than 10 s.

■ Class 20: starting time less than 20 s.

For a given class, it is necessary to check that all motor-feeder components are sized to withstand the 7.5 Ir starting current without excessive temperature rise during the time corresponding to the class.

##### Short-circuit protection (Ii)

Instantaneous protection with non-adjustable pick-up Ii=17 In.

#### Advanced protection (same as GV4PEM)

Settings are made with:

■ Android smartphone using wireless NFC (Near Field Communication), or EcoStruxure Power Device App. computer + EcoStruxure Power Commission software and configuration/maintenance tool kit TRV00910

■ LV434206 pocket battery, allows the GV4PB controller to be powered for adjustment and test. LV434206 pocket battery needs to be connected to the GV4PB controller to set the advanced protection.

##### Short time delay protection (I<sub>sd</sub>)

Short time delay protection (around 100 ms) to let through motor starting currents, but to protect cables and motor starter devices and allow not to oversize them (particularly useful for wide range settings circuit breakers).

Adjustable pick-up I<sub>sd</sub> = 5...13 Ir (13 by default).

##### Phase unbalance or phase loss (I<sub>unbal</sub>, I<sub>tunbal</sub>)

This function opens the circuit breaker if a phase unbalance occurs:

■ that is greater than the 10...40 % of Irms (30 % by default): I<sub>unbal</sub>

■ following a time delay (I<sub>tunbal</sub>) equal to:

□ 0.7 s during starting (non adjustable)

□ 1...10 s during normal operation (4 s by default).

Phase loss is an extreme case of phase unbalance and leads to tripping under the same conditions.

##### Ground-fault protection (I<sub>g</sub>, t<sub>g</sub>)

Residual type ground-fault protection, with OFF position:

■ adjustable pick-up I<sub>g</sub>:

□ 0.7...1 In for products with nominal current from 2 to 50 A

□ 0.4...1 In for products with nominal current from 80 to 115 A

■ adjustable time delay t<sub>g</sub> 0.1...0.4 s.

##### Jam (I<sub>jam</sub>, t<sub>jam</sub>)

This function detects locking of the motor shaft caused by the load, with OFF position (OFF by default). During motor starting the function is disabled.

During normal operation, it causes tripping:

■ above the I<sub>jam</sub> pick-up that can be fine-adjusted from 1.5 to 8 Ir

■ in conjunction with the t<sub>jam</sub> time delay that can be adjusted from 1 to 30 s.

##### Long start (I<sub>long</sub>, t<sub>long</sub>)

This protection supplements thermal protection (class). It is used to optimize the protection according to the starting parameters, with OFF position (OFF by default).

It detects abnormal motor starting i.e. when the starting current remains too high or too low with respect to a pick-up value and a time delay.

It causes tripping:

■ in relation with a I<sub>long</sub> pick-up that can be fine-adjusted from 1.5 to 8 Ir

■ in conjunction with the t<sub>long</sub> time delay that can be adjusted from 1 to 200 s.

#### Indications

##### Front indications

■ Green "Ready" LED: flashes slowly when the circuit breaker is ready to trip in the event of an abnormal deviation in engine operating conditions.

■ Red alarm LED: goes ON when the thermal image of the motor is greater than 95 % of the permissible temperature rise

##### Remote indications via SDx module

See description on page B6/44.

##### Conforming to standards:

IEC/EN 60947-2, IEC/EN 60947-4-1

##### Product certifications:

UL 489, CSA C22.2 n°5.



## References - TeSys GV4 - ½ to 60 HP/460 V

### TeSys protection components

#### Thermal-magnetic motor circuit breakers GV4PB

GV4PB - selection according to Short Circuit Current Rating (SCCR)			
240 V AC SCCR kA	480Y/277 V AC SCCR kA	600Y/347 V AC SCCR kA	Reference
35	18	14	GV4PB●●●B <sup>(1)</sup>
65	35	18	GV4PB●●●N
100	65	25	GV4PB●●●S

(1) Example: GV4PB07S, GV4PB115S.

GV4PB thermal magnetic motor circuit breakers - selection according to FLA							
3P 200 V FLA A	3P 230 V FLA A	3P 460 V FLA A	Rated %	Dial range A	Reference		
-	-	1.6	100	0.8 to 2		GV4PB02N	GV4PB02S
2.5	2.2	3	100	1.4 to 3.5		GV4PB03N	GV4PB03S
4.8	4.2	4.8	100	2.9 to 7		GV4PB07N	GV4PB07S
7.8	9.6	7.6	100	5 to 12.5		GV4PB12N	GV4PB12S
17.5	22	21	100	10 to 25	GV4PB25B	GV4PB25N	GV4PB25S
48	42	40	100	20 to 50	GV4PB50B	GV4PB50N	GV4PB50S
62	54	52	80	40 to 80	GV4PB80B	GV4PB80N	GV4PB80S
92	80	77	80	65 to 115	GV4PB115B	GV4PB115N	GV4PB115S

#### Connection by lugs

Please order GV4LUG accessory and LV426920 interphase barriers or L1D96590 terminal shield.

Circuit  
breakers

# TeSys protection components

## Auxiliary contact bloc



GV4AE11 auxiliary contact block

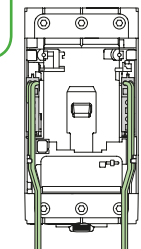
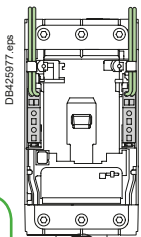
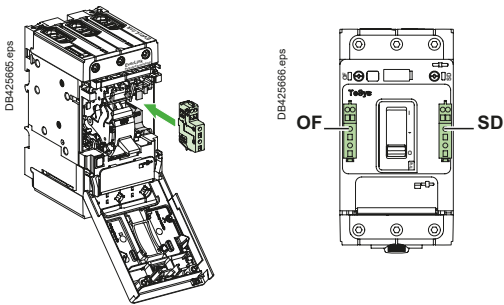

Circuit breakers

Pluggable auxiliary contact - OF or SD is dependent on cavity. Multiple internal wiring possibilities, even with long terminal shields

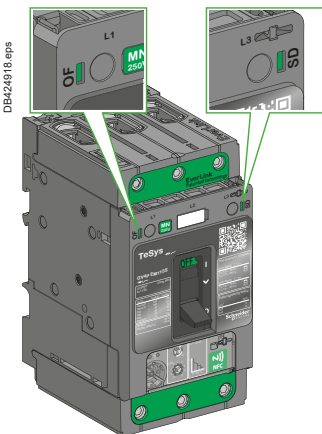

Visible presence of auxiliary contact block in OF or SD cavity

### Auxiliary contact blocks

Auxiliary contacts give an indication of the circuit breaker status. They can be used for remote visual signaling, alarming, electrical locking, relay activation, etc...

An auxiliary contact block provides one changeover contact with common point for OF or SD function, depending on the breaker cavity where it is inserted.

#### Auxiliary contact - Open/Close OF function

Indicates Open/Closed position of the circuit breaker contacts.

#### Auxiliary contact - Trip alarm SD function

■ Indicates that the circuit breaker has tripped due to:

- Electrical fault (overload, short circuit, ...)
- shunt trip
- undervoltage release
- "push-to-trip" button.

■ Resets when circuit breaker is reset.

#### Electrical characteristic

Characteristics						
Rated thermal current (A)	5					
Minimum load	2 mA at 17 V DC					
		AC12	AC15	DC12	DC13	DC14
Operational current (A)	24 V AC/DC	5	5	5	2.5	1
	48 V AC/DC	5	5	2.5	1.2	0.2
	110...127 V AC / 110 V DC	5	4	0.6	0.35	0.05
	220/240 V AC	5	3	-	-	-
	250 V DC	-	-	0.3	0.05	0.03
	380/440 V AC	5	2.5	-	-	-
	660/690 V AC	5	0.11	-	-	-

Pilot duty B600 according UL508 and CSA 22.2 n°14.

#### Installation and connection

■ Auxiliary contact blocks snap into left (for OF function) and right (for SD function) cavities behind the front accessory cover of the circuit breaker and their presence is visible on the front face through green flags.

■ One model serves for all indication functions depending on where it is fitted in the circuit breaker.

■ Each NO and NC spring terminal may be connected by one 0.5...1.5 mm<sup>2</sup> flexible copper wire and by two for the common point.

■ Wires can be exited out of any of the four corners of the breaker under the accessory cover.

Description	Maximum number	Mounting	Type of contacts	Sold in lots of	Reference
Auxiliary contact block for OF or SD indication	2 (1 OF + 1 SD)	Internal plug-in	NO + NC	1	GV4AE11

# TeSys protection components

## MX shunt trips, MN voltage releases



PB114963.eps

GV4AS137 shunt trip

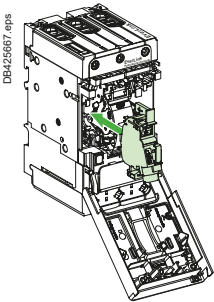

DB425687.eps

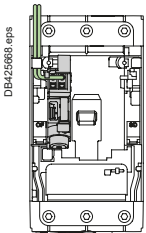

DB425686.eps

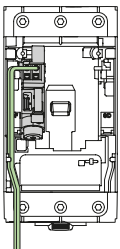

MN or MX plugged into cavity. Multiple internal wiring possibilities, even with long terminal shields

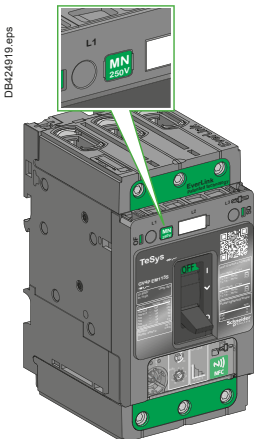

DB424919.eps

Visible presence of MN undervoltage release in circuit breaker cavity, visible rated voltage through the window.

### MX shunt trip, MN undervoltage release

MX and MN trip the circuit breaker on a control signal. They are mainly used for remote and emergency-off commands.

It is advised to test the system every six months.

#### MX shunt trip

- Trips the circuit breaker when the control voltage rises above 70 % of its rated voltage ( $U_n$ ).
- Impulse type  $\geq 20$  ms or maintained control signals.
- Shunt trip 110...130 V AC is suitable for ground-fault protection when combined with a Class I ground-fault sensing element.
- Continuous duty rated coil <sup>(1)</sup>.

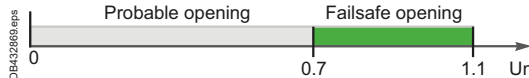

Opening conditions of the MX release.

#### MN undervoltage release

- Trips the circuit breaker when the control voltage drops below 35 % of its rated voltage.
- Between 35 % and 70 % of the rated voltage opening is only probable.
- Above 70 % of the rated voltage, opening does not take place.
- Continuous duty rated coil.
- Circuit breaker closing is possible only if the voltage exceeds 85 % of the rated voltage. If an undervoltage condition exists, operation of the closing mechanism of the circuit breaker will not permit the main contacts to touch, even momentarily. This is commonly called "Kiss Free".

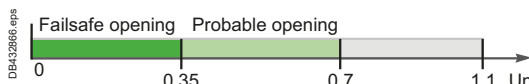

Opening conditions of the MN release.



Closing conditions of the MN release.

#### Installation, connection

Accessories snap into cavities under the circuit breaker front accessory cover. Spring-type terminals in order to insure a fast and reliable connection to 0.5...1.5 mm<sup>2</sup> flexible copper wire (one per terminal).

#### Operation

Circuit breaker must be locally reset after trip by shunt trip (MX) or undervoltage release (MN). Tripping by MX or MN has priority over manual closing; in the presence of a standing trip order such an action does not result in main contacts closing, even temporarily.

Description	Maximum number	Mounting	Voltage	Reference
MX Shunt trip	1	Internal, plug-in	24 V~ 50/60 Hz, 24 V=	GV4AS027
			48 V~ 50/60 Hz, 48 V=	GV4AS057
			110-130 V~ 50/60 Hz 125 V=	GV4AS137
			220-240 V~ 50 Hz, 208-240 V~ 60 Hz, 277 V 60 Hz	GV4AS287
			380-415 V~ 50 Hz, 440-480 V~ 60 Hz	GV4AS487
MN undervoltage release	1	Internal, plug-in	24 V~ 50/60 Hz, 24 V=	GV4AU027
			48 V~ 50/60 Hz, 48 V=	GV4AU057
			110-130 V~ 50/60 Hz 125 V=	GV4AU137
			220-240 V~ 50 Hz, 208-240 V~ 60 Hz	GV4AU247
			277 V~ 60 hZ	GV4AU286
			380-415 V~ 50 Hz	GV4AU415
440-480 V~ 60 Hz	GV4AU486			

<sup>(1)</sup> Except for MX 24 V AC/DC (in case of continuous activation, may generate some minor perturbation in sensitive environment).

Circuit breakers

# TeSys protection components

## SDx contact module for GV4PEM, GV4PB circuit breaker

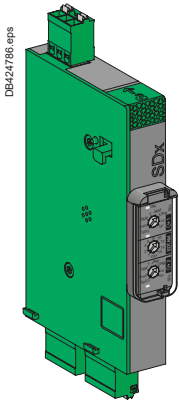

GV4ADM1111 SDx contact module

### SDx contact module for GV4PEM, GV4PB (Multifunction)

The SDx provides alarming and functional fault differentiation for GV4PEM, GV4PB (Multifunction) circuit breaker. This module has 2 NO/NC outputs dry contacts which can be assigned with one of the 8 following SD status:

- **SDT95%** overload alarm: thermal image of the motor is greater than 95 % of the permissible temperature rise.
- **SDTxxs** overload alarm: circuit breaker will trip in xx seconds with the same load. xx is adjustable between 10 to 40 seconds (default 20 seconds) on the circuit breaker itself through NFC or a computer with EcoStruxure Power Commission software and an interface module (TRV00911).
- **SDTAM** overload alarm just before tripping: in the event of a phase unbalance, overload, or on a jam fault, this output is activated to open the contactor and avoid circuit breaker tripping. In that case, contact can be manually or automatically reseted after an adjustable cooling time from 1 to 15 minutes. If after a 400 ms delay the motor is not stopped, the circuit breaker will trip.
- **SDT** overload trip indication: circuit breaker has tripped due to an overload fault
- **SDJAM** jam trip indication: circuit breaker has tripped due to a jam fault
- **SDUNB** phase unbalance trip indication: circuit breaker has tripped due to an unbalance fault
- **SDLS** long start trip indication: circuit breaker has tripped due to a long start fault
- **SDGF** ground-fault trip indication: circuit breaker has tripped due to a ground-fault.

Outputs are automatically resetted either when alarm disappears or when the circuit breaker is restarted.

#### Output characteristics

- 2 NO/NC dry contacts
- 24...250 V AC/DC
- Minimum load: 2 mA under 24 V DC
- Max load: 5 A
- AC15 (230 V max - 400 VA)
- DC13 (24 V - 50 W)

#### Power characteristics

- 24...240 V AC/DC

#### Contact rating (per UL/CSA B300 & R300)

Standard	Rated Voltage $U_e$	Operational Current $I_e$	Make	Break	$I_{th}$
			VA	VA	
B300	120 V AC	3	3600	360	5
	240 V AC	1.5			
R300	125 V DC	0.22	28	28	1
	250 V DC	0.1			

The rated operational current  $I_e$  (A), the rated operational voltage  $U_e$  (V) and the break apparent power  $B$  (VA) are correlated by the formula  $B = U_e \cdot I_e$ ; with  $I_e \leq I_{th}$ .

#### Installation, connection, settings and indication

The SDx module is clipped on the right side of the circuit breaker. Each removable spring terminal can be connected by one 0.5... 1.5 mm<sup>2</sup> copper wire. Settings and indications are available on the front face.

Circuit breakers

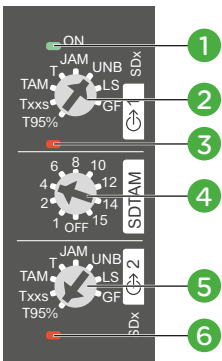

- 1 Green led lighted when the module is powered.
- 2 Output 1: SD status assignment.
- 3 Red led lighted when output 1 is activated.
- 4 Cooling time setting before automatic restart (OFF – 1...15 min).
- 5 Output 2: SD status assignment.
- 6 Red led lighted when output 2 is activated.

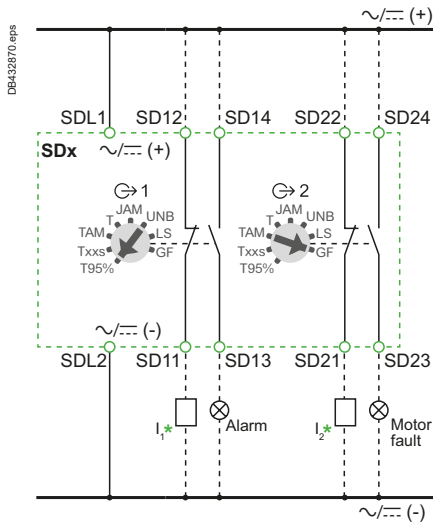

\* I1, I2: PLC digital inputs - used as alarm inputs, as an example.

SDx wiring diagram

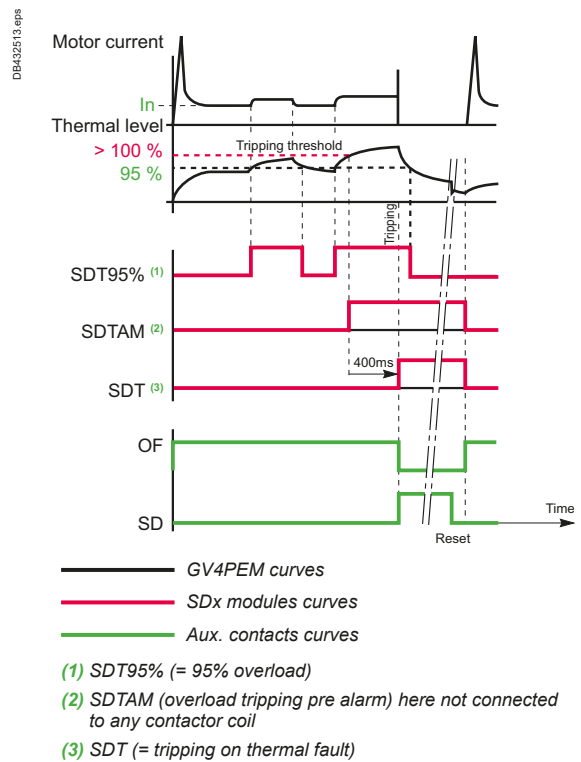

- GV4PEM curves
- SDx modules curves
- Aux. contacts curves

- (1) SDT95% (= 95% overload)
- (2) SDTAM (overload tripping pre alarm) here not connected to any contactor coil
- (3) SDT (= tripping on thermal fault)

Description	Mounting	Maximum number	Type of contacts	Unit reference
SDx: alarming / fault differentiation module	Side	2	N/O / N/C	GV4ADM1111

# TeSys protection components

## Rotary handles

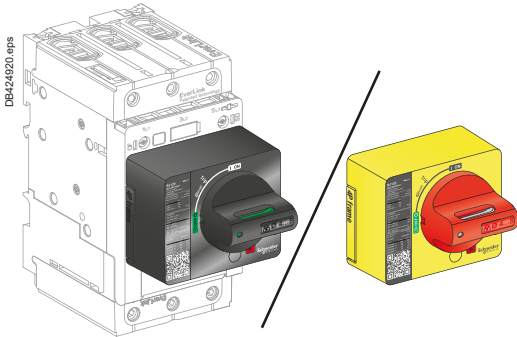

Direct mounting rotary handle

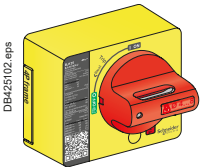

GV4ADN02 direct mounting rotary handle

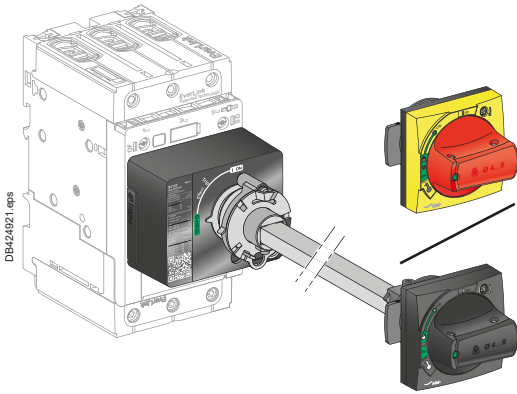

Front extended rotary handle (door-mounting)

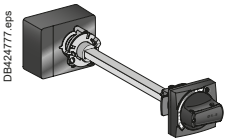

GV4APN01 front extended rotary handle kit

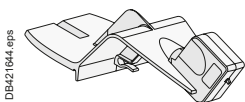

GVAPL01 laser tool

### Direct mounting rotary handles

#### Installation

The direct mounting rotary handle has to be mounted by 3 screws on the front accessory cover.

#### Operation

The direct mounting rotary handle maintains:

- suitability for isolation
- indication of the three positions OFF (O), ON (I) and tripped (Trip)
- access to the "push-to-trip" button
- visibility and access to the trip unit.

#### Device padlocking

The circuit breaker may be locked in the OFF position by using one to three padlocks (not supplied) or in ON position after customer modification of the rotary handle before installation, padlock shackle Ø4-8 mm. Locking in the ON position does not prevent the circuit breaker from tripping if a circuit or motor malfunction occurs. In this case, the handle remains in the ON position after the circuit breaker trips. Unlocking is required for the handle to go to the tripped then the OFF position.

#### Variations: door locking

Door locking built-in functionality can be activated by the customer to prevent opening the door when the circuit breaker is ON or in trip position. For exceptional situations, door locking can be temporarily disabled with a tool by qualified personnel to open the door when the circuit breaker is closed.

Description	Type	Degree of protection	Reference
Direct mounting rotary handle	Black handle	IP40	GV4ADN01
	Red handle on yellow bezel (VDE standard, for machine control)	IP40	GV4ADN02

### Front extended rotary handles

#### Installation

The door-mounted (extended) rotary handle is made up of:

- a unit that has to be screwed on the front accessory cover of the circuit breaker
- an assembly (handle mechanism and front plate) on the door that is always secured in the same position, whether the circuit breaker is installed vertically or horizontally
- an adjustable extension shaft.

The handle mechanism is fixed with a nut (Ø22 mm) to make assembly easier. The Laser Square tool (GVAPL01) can be used to accurately align the hole on the door with the circuit breaker.

#### Operation when door is closed

The door mounted handle makes it possible to operate a circuit breaker installed in an enclosure from the front. The door mounted operating handle maintains:

- suitability for isolation
- indication of the three positions OFF (O), ON (I) and tripped (Trip)
- visibility and access to trip unit when the door is open
- degree of protection of the handle on the door: IP54 or IP65 as per IEC 60529.

#### Mechanical door locking when device closed

A standard feature of the extended rotary handle is a locking function, built into the shaft, that disables door opening when the circuit breaker is in the ON or tripped positions.

Door locking can be temporarily disabled with a tool by qualified personnel to open the door without opening the circuit breaker. This operation is not possible if the handle is locked by a padlock.

#### Device and door padlocking

Padlocking locks the circuit breaker handle and disables door opening:

- standard situation, in the OFF position, using 1 to 3 padlocks, shackle Ø4-8 mm, padlocks are not supplied
- for the black handle, with a voluntary modification of the door handle (to be done by the customer during installation), in the ON and OFF positions. Locking in the ON position does not prevent the circuit breaker from tripping if a circuit or motor malfunction occurs. In this case, the handle remains in the ON position after the circuit breaker trips. Unlocking is required for the handle to go to the tripped then the OFF position.

#### Shaft length

The shaft length is the distance between the back of the circuit breaker and the door:

- minimum shaft length is 214 mm
- maximum shaft length is 627 mm
- shaft length must be adjusted.

# TeSys protection components

## Rotary handles

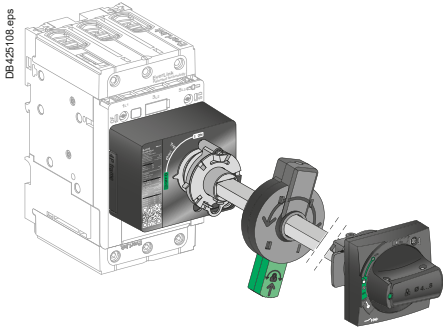

Open door shaft operator mounted on front extended rotary handle assembly

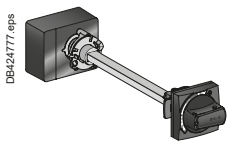

GV4APN01  
Front extended rotary handle kit

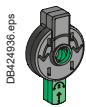

LV426937  
Open door shaft operator

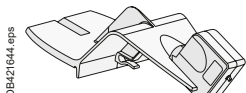

GVAPL01 - Laser tool

Circuit breakers

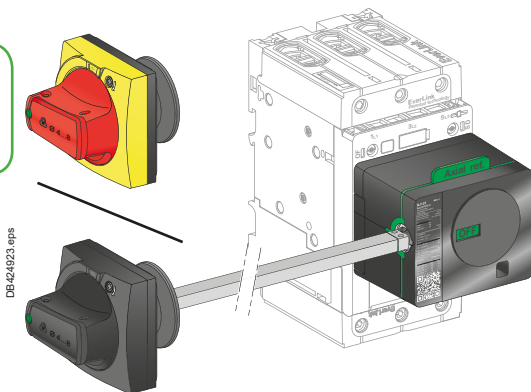

Side extended rotary handle (cover mounting)

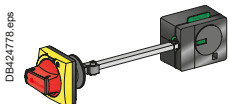

LV426936 - Side rotary handle kit

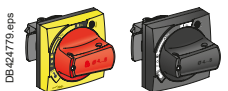

LV426998, LV426997 - Universal handles

### Front extended rotary handles (cont.)

#### Operation when door is opened

An open door shaft operator can be used to operate the circuit breaker when door is opened. This accessory complies with UL508 A. The indication of the three positions OFF (O), ON (I) and tripped (Trip) is visible on the circuit breaker. The circuit breaker itself may be locked in OFF position when the door is opened by 1 padlock / lockout hasp, shackle Ø4-8 mm.

Description	Type	Degree of protection	Reference
Front extended rotary handle kit	Black handle	IP54	GV4APN01
	Red handle on yellow bezel	IP54	GV4APN02
		IP65	GV4APN04
Open door shaft operator			LV426937
Laser tool			GVAPL01
Spare part: GV4 universal handle (for replacement of front. ext. or side rotary handle)	Black handle	IP54	LV426997
	Red handle on yellow bezel	IP54	LV426998
		IP65	LV426999

### Side rotary handles (left or right)

#### Installation

The side-mounted rotary handle is made up of:

- a unit that has to be screwed on the front accessory cover of the circuit breaker
- an assembly (handle and front plate) on the side (left or right) of the enclosure
- an adjustable extension shaft

The handle mechanism is fixed with a nut (Ø22 mm) to make assembly easier.

#### Operation

The side mounted rotary handle makes it possible to operate circuit breakers installed in enclosure from the side. The side mounted rotary handle maintains:

- suitability for isolation
- indication of the three positions OFF (O), ON (I) and tripped (Trip). Moreover, the position is visible on the circuit breaker itself
- visibility and access to trip unit when the door is open
- degree of protection of the handle on the side: IP54 or IP65 as per IEC 529.

#### Device padlocking

The circuit breaker may be locked in the OFF position, or, for the black rotary handle only, in ON position after voluntary modification of the side handle (to be done by the customer during installation), by using one to three padlocks, padlock shackle Ø4-8 mm ; padlocks are not supplied.

Locking in the ON position does not prevent free circuit breaker from tripping if a circuit or motor malfunction occurs. In this case, the handle remains in the ON position after the circuit breaker tripping. Unlocking is required to go to the tripped then the OFF position.

#### Shaft length

The shaft length is the distance between the side of the circuit breaker and the side of the enclosure:

- minimum shaft length is 45 mm
- maximum shaft length is 480 mm
- shaft length must be adjusted.

Description	Type	Degree of protection	Reference
Side rotary handle kit	Black handle	IP54	LV426935
	Red handle on yellow bezel (VDE standard, for machine control)	IP54 <sup>(1)</sup>	LV426936
Spare part: GV4 universal handle (for replacement of front. ext. or side rotary handle)	Black handle	IP54	LV426997
	Red handle on yellow bezel	IP54	LV426998
		IP65	

<sup>(1)</sup> IP65 possible with LV426935 kit (Black handle not used) + LV426999 Red handle on yellow bezel universal handle.

# TeSys protection components

## Locks and sealing accessories

### Handle padlocking devices

Padlocking systems can receive up to three padlocks with diameters of 5-8 mm (4-8 mm for rotary handles); padlocks not supplied. Locking in the OFF position guarantees isolation as per IEC 60947-2.

#### Direct rotary handle padlocking

By padlock – No accessory required.

- Lock in OFF position.
- Lock in ON position with simple mechanism modification.

#### Front Extended /Side rotary handle padlocking

By padlock – No accessory required.

- Lock in OFF position.
- Lock in ON position with simple mechanism modification (black handle only).  
Door opening prevented.

#### Toggle handle padlocking

By padlock – removable toggle locking device required **29370**.

- Lock in OFF position.

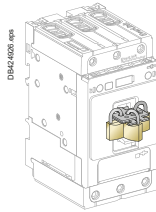

3 padlocks mounted on 29370 toggle locking device

Description	Reference
Removable toggle locking device for 1 to 3 padlocks	<b>29370</b>

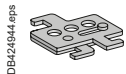

29370 removable toggle locking device

### Sealing devices

Control type

- Front removal.
- Access to auxiliaries.
- Access to settings and test connector.

Toggle

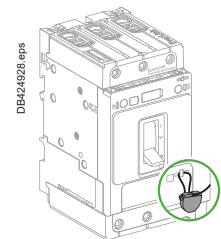
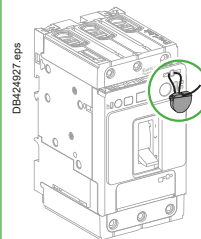

Rotary handle

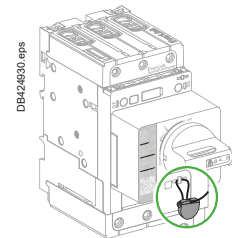
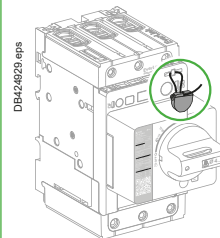

Description	Reference
Bag of 6 leads + 6 sealing accessories	<b>LV429375</b>



LV429375 leads + sealing accessories

Circuit breakers

# References - TeSys GV4 - 0.25 to 55 kW

## TeSys protection components

Cabling, test accessories, softwares

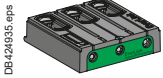

DB424935.eps  
**LAD96595**  
EverLink connector

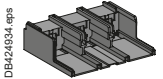

DB424934.eps  
**GV4LUG**  
crimped lug connector

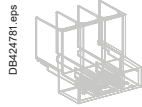

DB424781.eps  
**LAD96590**  
transparent terminal shield

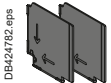

DB424782.eps  
**LV426920**  
interphase barriers

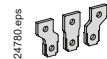

DB424780.eps  
**LV426940**  
spreader 3-pole

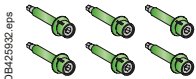

DB426992.eps  
**LV426990**  
9 N.m green throwaway bits



DB426931.eps  
**LV426992**  
5 N.m yellow throwaway bits



DB424939R.eps  
**LV434206**  
pocket battery



DB424938.eps  
**TRV00910**  
maintenance case



DB424939.eps  
**TRV00911**  
Spare USB maintenance interface

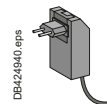

DB424940.eps  
**TRV00915**  
spare power supply  
110-240 V AC



DB424941.eps  
**TRV00917**  
spare GV4PEM cord for  
USB maintenance interface

Circuit breakers

### EverLink power connection

Description	Reference
EverLink connector	<b>LAD96595</b>

### Crimp lug/busbar connection

Description	Sold in lots of	Reference
Crimped lug connector + screws	1	<b>GV4LUG</b>
Transparent terminal shield for crimped lug connector	1	<b>LAD96590</b>
Interphase barriers	6	<b>LV426920</b>
Spreader 3-pole	To increase the pitch to 35 mm	<b>LV426940</b>

### Limited torque throwaway bits

Description	Sold in lots of	Reference
Green - 9 N.m	6	<b>LV426990</b>
Yellow - 5 N.m	6	<b>LV426992</b>

**Note:** torque limiting breakaway bits may be used, particularly in the field, to tighten at the right torque EverLink™ or compression lug power connections.

### Test tool, software, demo for GV4PEM

#### Test tool

Pocket battery	<b>LV434206</b>
Allows the GV4PEM or GV4PB controller to be powered for adjustments and tests when no internal source is available.	
Maintenance case	<b>TRV00910</b>
Comprising:	
■ USB maintenance interface	
■ Power supply	
■ GV4PEM cord	
■ USB cord	
■ RJ45/RJ45 male cord	
Spare USB maintenance interface	<b>TRV00911</b>
Spare power supply 110-240 V AC	<b>TRV00915</b>
Spare GV4PEM cord for USB maintenance interface	<b>TRV00917</b>

#### Software

Configuration and setting software EcoStruxure Power Commission	<b>Free download</b>
---	----------------------



# TeSys GV5/GV6

55 to 250 kW



Circuit  
breakers



## References - TeSys GV5 and GV6 - 55 to 250 kW

### TeSys protection components

#### Thermal-magnetic motor circuit breakers GV5P and GV6P

PB120638.eps



GV5P220F

#### Thermal-magnetic circuit breakers GV5P with screw clamp terminals up to 110 kW <sup>(1)</sup>

Control by direct rotary handle										Thermal setting range (Ir)	Reference	Weight
Standard power ratings of 3-phase motors 50/60 Hz in category AC-3												
400/415 V			500 V			660/690 V			A	kg		
P	Icu	Ics <sup>(2)</sup>	P	Icu	Ics <sup>(2)</sup>	P	Icu	Ics <sup>(2)</sup>				
kW	kA	%	kW	kA	%	kW	kA	%				
55...75	36	100	75...90	30	100	90...110	8	100	70...150	GV5P150F	2.4	
		70			50		100			10		100
90...110	36	100	110	30	100	110...132	8	100	100...220	GV5P220F	2.6	
		70			50		100			10		100

<sup>(1)</sup> Breakers have to be used with suitable rating of contactors, as defined in section A6.

<sup>(2)</sup> As % of Icu.

PB120633.eps



GV6P320F

#### Thermal-magnetic circuit breakers GV6P with screw clamp terminals up to 250 kW <sup>(1)</sup>

Control by direct rotary handle										Thermal setting range (Ir)	Reference	Weight
Standard power ratings of 3-phase motors 50/60 Hz in category AC-3												
400/415 V			500 V			660/690 V			A	kg		
P	Icu	Ics <sup>(2)</sup>	P	Icu	Ics <sup>(2)</sup>	P	Icu	Ics <sup>(2)</sup>				
kW	kA	%	kW	kA	%	kW	kA	%				
132...160	36	100	160...200	25	100	200...250	10	100	160...320	GV6P320F	6.5	
		70			50		100			10		100
200...250	36	100	250...315	25	100	315...400	10	100	250...500	GV6P500F	6.7	
		70			50		100			10		100

<sup>(1)</sup> Breakers have to be used with suitable rating of contactors, as defined in section A6.

<sup>(2)</sup> As % of Icu.

#### Thermal-magnetic circuit breakers GV5P/GV6P with screw clamp terminals <sup>(1)</sup>

Control by direct rotary handle					
Thermal setting	3-Phase			Standard breaking capacity	High breaking capacity
	230 V	460 V	575 V		
A	HP	HP	HP	Reference	Reference
90...150	50	100	150	GV5P150F	GV5P150H
133...220	75	150	200	GV5P220F	GV5P220H
160...320	125	250	300	GV6P320F	GV6P320H
250...500	150	350	500	GV6P500F	GV6P500H

<sup>(1)</sup> Breakers have to be used with suitable rating of contactors, as defined in section A6.

Circuit breakers

# Add-on blocks and accessories for GV5 motor circuit breaker

DE432613.ai

Circuit breakers

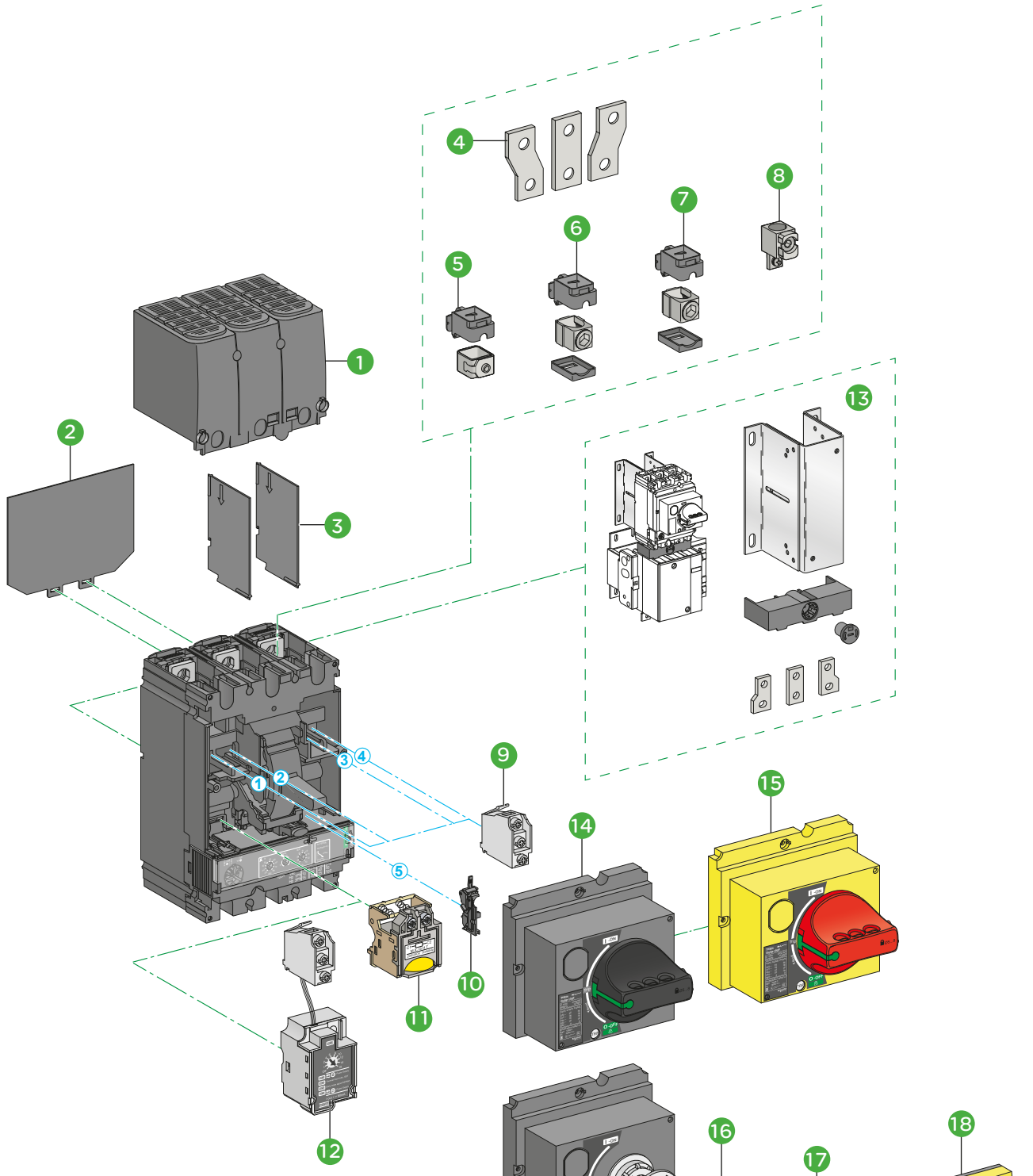

1...5: function related to each contact location, please refer to B6/54.

- 1 Terminal shield **GV7AC01**
- 2 Insulating screen **GV7AC05**
- 3 Interphase barriers **GV7AC04**
- 4 Spreaders 45 mm **GV7AC03**
- 5 Steel connector **GV7AC021** (1.5-95 mm<sup>2</sup>)
- 6 Aluminum connector **LV429227** (25-95 mm<sup>2</sup>)
- 7 Aluminum connector **GV7AC022** (120-185 mm<sup>2</sup>)
- 8 Aluminum connector **LV429244** (120-240 mm<sup>2</sup>)
- 9 OF, SD, or SDE indication contacts **GV7AE11** (standard) / **GV7AB11** (for low level)
- 10 SDE adapter **LV429451**
- 11 AU (UVR) or AS (SHT) voltage release **GV7AU●●●** / **GV7AS●●●**
- 12 SDTAM thermal fault module **LV429424**
- 13 Combination kit for contactor **GV7AC06/GV7AC07/GV7AC08**
- 14 Direct rotary handle black **GV5AP03** (shipped with the device)
- 15 Direct rotary handle red on yellow bezel **GV7AP04**
- 16 Open door shaft operator **LV426937**
- 17 Extended rotary handle black **GV7AP01**
- 18 Extended rotary handle red on yellow bezel **GV7AP02**

DE-432814.ai

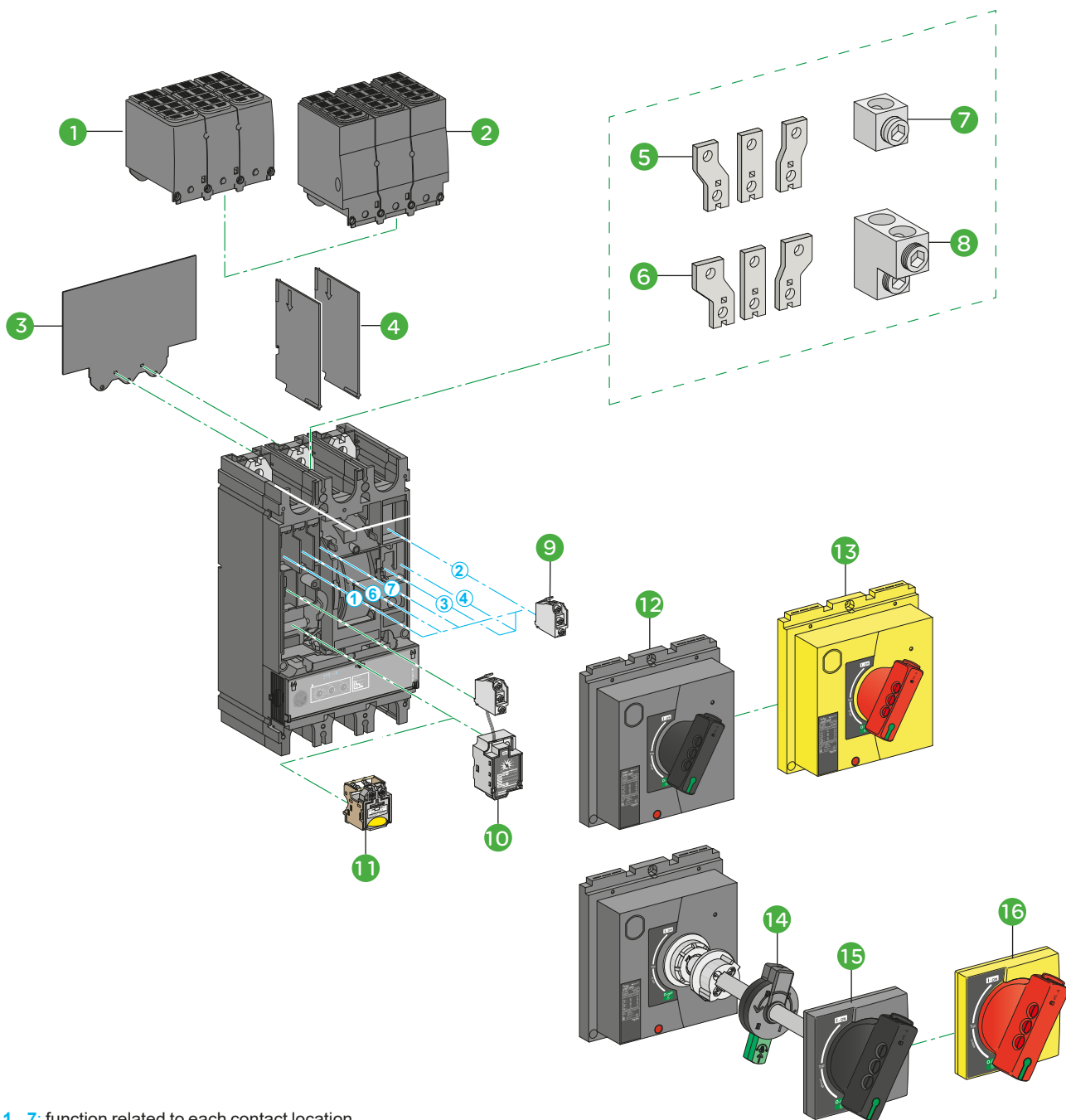

Circuit breakers

1...7: function related to each contact location, please refer to B6/54.

- ① Terminal shield 45 mm **LV432593**
- ② Terminal shield 52.5 mm **LV432595**
- ③ Interphase barriers **LV432570**
- ④ Insulating screen **LV432578**
- ⑤ Spreader 52.5 mm **LV432490**
- ⑥ Spreader 70 mm **LV432492**
- ⑦ Aluminum connector **LV432479** (1 x 35-300 mm<sup>2</sup>)
- ⑧ Aluminum connector **LV432481** (2 x 35-300 mm<sup>2</sup>)
- ⑨ OF, SD, or SDE indication contacts **GV7AE11** (standard) / **GV7AB11** (for low level)
- ⑩ SDTAM thermal fault module **LV429424**
- ⑪ AU (UVR) or AS (SHT) voltage releases **GV7AU●●●** / **GV7AUS●●●**
- ⑫ Direct rotary handle black **GV6AP03** (shipped with the device)
- ⑬ Direct rotary handle red on yellow bezel **LV432599**
- ⑭ Open door shaft operator **LV426937**
- ⑮ Extended rotary handle black **LV432598**
- ⑯ Extended rotary handle red on yellow bezel **LV432600**

## TeSys protection components

Thermal-magnetic motor circuit breakers GV5P/GV6P with screw clamp connections  
Add-on blocks and accessories

### Add-on auxiliary contacts - OF contacts

These allow remote indication of the circuit breaker contact states. They can be used for signalling, electrical locking, relaying, etc. They are available in two versions: standard and low level. They include a terminal block and the auxiliary circuits leave the circuit breaker through a hole provided for this purpose. They perform the following functions, depending on where they are located in the circuit breaker:

Location	Function	Application
1 and/or 4 (GV5) 1 and/or 4, 6, 7 (GV6)	C/O contact	Indicates the position of the circuit breaker poles.
2	Trip indication	Indicates that the circuit breaker has tripped due to an overload, a short-circuit, a differential fault or the operation of a voltage trip (undervoltage or shunt trip), or of the "push to trip" test button. It resets when the circuit breaker is reset.
3	Electrical fault indication	Indicates that the circuit breaker has tripped due to an overload, a short-circuit or a differential fault. It resets when the circuit breaker is reset.
5	Adapter for electrical fault indication	This accessory is mandatory for GV5 to provide electrical fault indication.

Type	Reference
Standard	GV7AE11
Low level	GV7AB11
Adapter for electrical fault indication	LV429451

### Thermal fault module - SDTAM

GV5/ GV6 can be equipped with thermal fault module. This module have:

- a contact to indicate overload fault in the circuit-breaker
- a contact to open the contactor. In the event of overload or phase unbalance, this output is activated 400 ms before circuit-breaker tripping to open the contactor and avoid circuit breaker tripping.

Voltage	Reference
24...415 V AC/DC	LV429424 <sup>(1)</sup>

### Electric trips

These allow the circuit breaker to be tripped via an electrical control signal.

- Undervoltage release (UVR) - GV7AU
- Trips the circuit breaker when the control voltage drops below 35 % of its rated voltage.
- Between 35 % and 70 % of the rated voltage opening is possible but not guaranteed.
- Above 70 % of the rated voltage, opening does not take place.
- Continuous duty rated coil.
- Circuit breaker closing is possible only if the voltage exceeds 85 % of the rated voltage.
- Shunt trip (SHT) - GV7AS
- Trips the circuit breaker when the control voltage rises above 0.7 times the rated voltage.
- Impulse type  $\geq 20$  ms or maintained control signals.
- Operation (GV7AU or GV7AS)
- When the circuit breaker has been tripped by a GV7 AU or AS, it must be reset either locally.
- Tripping has priority over manual closing: if a tripping order is present, manual action does not result in closing, even temporarily, of the contacts.
- Durability: 50 % of the mechanical durability of the circuit breaker.

Type	Voltage	Reference
Undervoltage trip	48 V, 50/60 Hz	GV7AU055
	110...130 V, 50/60 Hz	GV7AU107
	200...240 V, 50/60 Hz	GV7AU207
	380...440 V, 50/60 Hz	GV7AU387
Shunt trip	48 V, 50/60 Hz	GV7AS055
	110...130 V, 50/60 Hz	GV7AS107
	200...240 V, 50/60 Hz	GV7AS207
	380...440 V, 50/60 Hz	GV7AS387

<sup>(1)</sup> LV429429 takes the place of the AU/AS electric trip coil and an auxiliary contact (C/O contact 1).

## TeSys protection components

Thermal-magnetic motor circuit breakers GV5P/GV6P with screw clamp connections

Accessories



LV432479



LV432490



LV432593

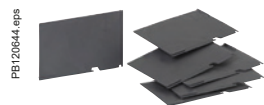

GV7AC04



GV6AP03



LV432599



GV7AP02

## Cabling accessories

**Cable connectors:** The connectors for GV5 snap directly on to the device terminals or are secured by clips to right-angle and straight terminal extensions as well as spreaders. GV6 connectors are screwed directly to the device terminals.

**Spreaders:** Spreaders may be used to increase the pitch from 35 mm to 45 mm for GV5. The 45 mm pitch can be increased to 52.5 or 70 mm for GV6.

**Long terminal shields:** They are used for front connection with cables or insulated bars. They comprise two parts assembled with captive screws, forming an IP40 cover. The top part is equipped with sliding grids with break marks for precise adaptation to cables or insulated bars. The rear part completely blocks off the connection zone. Partially cut squares can be removed to adapt to all types of connection for cables with lugs or copper bars. Long terminal shields may be mounted upstream and downstream of the breaker.

**Phase barriers:** These interphase barriers are used for maximum insulation at the power-connection points.

**Insulating screens:** These are fitted at the rear of the device which provides insulation. Their use is mandatory for devices with spreaders, installed on backplates, when terminal shields are not used.

**GV5 Combination kits:** These kits allow link between the circuit breaker and the contactor. The cover provides protection against direct finger contact. The kit comprises links, a protective shield and a depth adjustable metal bracket for the breaker.

Description	Application	Sold in lots of	Unit reference GV5	Unit reference GV6
<b>Steel connectors (set of 3)</b>	1.5...95 mm <sup>2</sup> ≤ 150 A	1	GV7AC021	–
<b>Aluminium connectors (set of 3)</b>	25...95 mm <sup>2</sup> ≤ 220 A	1	LV429227	
	120...185 mm <sup>2</sup> ≤ 220 A	1	GV7AC022	
	120...240 mm <sup>2</sup> ≤ 220 A	1	LV429244	
<b>Spreader 3-pole <sup>(1)</sup></b>	35...45 mm pole pitch	1	GV7AC03	
	52.5 mm pole pitch	1		LV432490
<b>Long terminal shield (IP40) <sup>(1)</sup></b>	70 mm pole pitch	1		LV432492
	35 mm pole pitch	1	GV7AC01	
	45 mm pole pitch	1		LV432593
<b>Phase barriers (set of 6)</b>	52.5 mm pole pitch	1		LV432595
		1	GV7AC04	LV432570
<b>Insulating screens (set of 2)</b>	45 mm	1	GV7AC05	
	70 mm			LV432578
<b>Combination Kits <sup>(2)</sup></b>				
<b>For contactor LC1 F115...F185</b>	Connection kits between breaker and contactor	1	GV7AC06	
<b>For contactor LC1 F225 and F265</b>		1	GV7AC07	
<b>For contactor LC1 D115 and D150</b>		1	GV7AC08	

## Direct rotary handle

The circuit breaker is always supplied direct rotary handle (black handle, black plate) as standard and it provides IP40 protection. The other type handles can be used by replacing this direct rotary handle. It includes a device for locking the circuit breaker in the O (Off) position by means of up to 3 padlocks with a shackle diameter of 5 to 8 mm (padlocks not included). A MCC conversion accessory allows the direct rotary handle to be mounted on the enclosure door. In this case, the door cannot be opened if the circuit breaker is in the "ON" position. Circuit breaker closing is inhibited if the enclosure door is open and prevents the device from being closed if the door is open.

Description	Type	Sold in lots of	Unit reference GV5	Unit reference GV6
<b>Direct rotary handle</b>	Black handle, black legend plate	1	GV5AP03	GV6AP03
	Red handle, yellow legend plate	1	GV7AP04	LV432599
<b>MCC conversion accessory</b>	Four mounting direct rotary handle on enclosure door	1	GV7AP05	LV432606

## Extended rotary handle

Allows to operate a circuit breaker from the front of the switch board, which's installed in the back of an enclosure, which provides IP55 protection. It comprises:

- a unit which is screwed onto the front accessory cover of the circuit breaker,
- an assembly (handle mechanism and front plate) to be fitted on the enclosure door,
- an extension shaft which must be adjusted.
- The distance minimum and maximum distances between the mounting surface and the door are
  - 185...600 mm for GV5
  - 209...600 mm for GV6

It includes a device for locking the circuit breaker in the O (Off) position by means of up to 3 padlocks with a shackle diameter of 5 to 8 mm (padlocks not included) and disables opening enclosure door.

Description	Type	Sold in lots of	Unit reference GV5	Unit reference GV6
<b>Extended rotary handle</b>	Black handle, black legend plate	1	GV7AP01	LV432598
	Red handle, yellow legend plate	1	GV7AP02	LV432600

<sup>(1)</sup> Terminal shields cannot be used together with spreaders.

<sup>(2)</sup> The kit comprises links, a protective shield and a depth adjustable metal bracket for the breaker.

## TeSys protection components

Thermal-magnetic motor circuit breakers GV5P/GV6P with screw clamp connections

Accessories

### Front extended rotary handles (cont.)

#### Operation when door is opened

An open door shaft operator can be used to operate the circuit breaker when door is opened. This accessory complies with UL508 A.

The indication of the three positions OFF (O), ON (I) and tripped (Trip) is visible on the circuit breaker.

The circuit breaker itself may be locked in OFF position when the door is opened by 1 padlock / lockout hasp, shackle Ø4-8 mm.

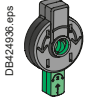

LV426937  
Open door shaft operator

Description	Reference
Open door shaft operator	LV426937
Laser tool	GVAPL01

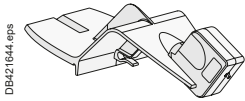

GVAPL01 Laser tool

### Other accessories

Bag of 6 tamper seals + 6 cover caps (1 large, 5 small) for screw heads

LV429375



LVA429375  
Sealing accessories



# TeSys GB2

0.5 to 20 A

(for equipment and control circuits)



Circuit  
breakers

## Protection components

Thermal-magnetic circuit breakers TeSys GB2 for the protection of industrial equipment control circuits

### Presentation

GB2 thermal-magnetic circuit breakers protect and isolate the control circuits of industrial equipment with contactor coils, transformers....

They protect and isolate single-phase auxiliary circuits such as solenoid valves, electro-brakes, battery chargers, supplied from the control circuit voltage.

### GB2CB, GB2CD, GB2DB

12 ratings are available, from 0.5 to 20 A, in single-pole (GB2CB), single-pole + neutral (GB2CD) and 2-pole (GB2DB) versions.

They have a magnetic tripping threshold set at between 12 and 16 In to withstand the current peaks generated by many industrial components.

### GB2 CS

2 ratings are available, 0.5 and 1 A, in single-pole version.

The magnetic tripping threshold is set between 5 and 7 In.

### Functions, installation

Clip-on fixing onto all types of 35 mm  $\perp$  rails, on  $\perp$  rails and on Telequick mounting plates.

Upstream and downstream marking by means of AB1 clip-in markers.

Clear indication of "I" and "O" positions on the operator.

Tamper-proof device which requires no special maintenance (fixed magnetic and thermal tripping thresholds).

### Selection for the protection of circuits supplied by transformers

Single-phase transformers.

Magnetising peak: 20 In.

Operation of magnetic trips: 13 In.

Power VA	Primary <sup>(1)</sup>		Secondary			
	220/240 V	380/415 V	24 V	48 V	110 V	220 V
40	GB2DB05	GB2DB05	GB2CD07	GB2CD06	GB2CD05	GB2CD05
63	GB2DB05	GB2DB05	GB2CD08	GB2CD07	GB2CD06	GB2CD05
100	GB2DB06	GB2DB05	GB2CD10	GB2CD07	GB2CD06	GB2CD05
160	GB2DB07	GB2DB06	GB2CD14	GB2CD09	GB2CD07	GB2CD06
250	GB2DB07	GB2DB06	GB2CD16	GB2CD12	GB2CD08	GB2CD07
400	GB2DB08	GB2DB07	GB2CD22	GB2CD14	GB2CD09	GB2CD07
630	GB2DB10	GB2DB08	–	GB2CD21	GB2CD12	GB2CD08
1000	GB2DB14	GB2DB09	–	–	GB2CD16	GB2CD10
1600	GB2DB20	GB2DB14	–	–	–	GB2CD14
2000	GB2DB21	GB2DB14	–	–	GB2CD22	GB2CD16
2500	GB2DB22	GB2DB20	–	–	–	GB2CD20
3000	GB2DB22	GB2DB20	–	–	–	GB2CD21
4000	–	GB2DB21	–	–	–	GB2CD22
5000	–	GB2DB22	–	–	–	–

<sup>(1)</sup> If the breaking capacity of the GB2 is insufficient, use a GV2RT with 2 poles connected in series.

## Protection components

Thermal-magnetic circuit breakers TeSys GB2 for the protection of industrial equipment control circuits

DF520243.tif



GB2CB●●

DF520244.tif



GB2CD●●

DF520245.tif



GB2DB●●

### Circuit breakers with magnetic tripping threshold: 12 to 16 In

#### Single-pole

Conventional rated thermal current Ith <sup>(1)</sup>	Magnetic tripping current Id ± 20 %	Sold in lots of	Unit reference
<b>A</b>	<b>A</b>		
0.5	6.6	6	GB2CB05
1	14	6	GB2CB06
2	26	6	GB2CB07
3	40	6	GB2CB08
4	52	6	GB2CB09
5	66	6	GB2CB10
6	83	6	GB2CB12
8	108	6	GB2CB14
10	138	6	GB2CB16
12	165	6	GB2CB20
16	220	6	GB2CB21
20	270	6	GB2CB22

#### Single-pole + neutral

Conventional rated thermal current Ith <sup>(1)</sup>	Magnetic tripping current Id ± 20 %	Sold in lots of	Unit reference
<b>A</b>	<b>A</b>		
0.5	6.6	6	GB2CD05
1	14	6	GB2CD06
2	26	6	GB2CD07
3	40	6	GB2CD08
4	52	6	GB2CD09
5	66	6	GB2CD10
6	83	6	GB2CD12
8	108	6	GB2CD14
10	138	6	GB2CD16
12	165	6	GB2CD20
16	220	6	GB2CD21
20	270	6	GB2CD22

#### 2-pole

Conventional rated thermal current Ith <sup>(1)</sup>	Magnetic tripping current Id ± 20 %	Sold in lots of	Unit reference
<b>A</b>	<b>A</b>		
0.5	6.6	3	GB2DB05
1	14	3	GB2DB06
2	26	3	GB2DB07
3	40	3	GB2DB08
4	50	3	GB2DB09
5	66	3	GB2DB10
6	83	3	GB2DB12
8	108	3	GB2DB14
10	138	3	GB2DB16
12	165	3	GB2DB20
16	220	3	GB2DB21
20	270	3	GB2DB22

(1) Conforming to IEC 60947-1.

## Protection components

Thermal-magnetic circuit breakers TeSys GB2 for the protection of industrial equipment control circuits

### Circuit breakers with magnetic tripping threshold: 5 to 7 In

DF526246.fr



GB2CS●●

Single-pole			
Conventional rated thermal current Ith <sup>(1)</sup>	Magnetic tripping current Id ± 20 %	Sold in lots of	Unit reference
A	A		
0.5	3.3	6	GB2CS05
<hr/>			
1	6	6	GB2CS06

<sup>(1)</sup> Conforming to IEC 60947-1.

### Accessories for circuit breakers GB2-CB, DB and CS

Description	Sold in lots of	Unit reference
Busbar set for supply to 10 GB2 DB or 20 GB2 CB or GB2 CS with 2 connectors	1	GB2G210
<hr/>		
Supply connector	10	GB2G01

Circuit breakers

## Technical Data for Designers

### Contents

#### TeSys GV2:

- > characteristics ..... B6/64 to B6/68
- > curves ..... B6/69 to B6/78
- > accessories ..... B6/79 to B6/80
- > dimensions, schemes ..... B6/82 to B6/91

#### TeSys GV3:

- > characteristics ..... B6/94 to B6/97
- > curves ..... B6/98 to B6/103
- > accessories ..... B6/104 to B6/106
- > dimensions, schemes ..... B6/107 to B6/109

#### TeSys GV4:

- > characteristics ..... B6/112 to B6/115
- > curves ..... B6/116 to B6/123
- > accessories ..... B6/124 to B6/125
- > dimensions, schemes ..... B6/126 to B6/129

#### TeSys GV5/GV6:

- > characteristics ..... B6/132
- > curves ..... B6/133 to B6/135
- > accessories ..... B6/136 to B6/137
- > dimensions, schemes ..... B6/138 to B6/144

#### TeSys GB2:

- > characteristics ..... B6/146 to B6/148
- > dimensions, schemes ..... B6/149



# TeSys GV2

0.06 to 15 kW



# Characteristics - TeSys GV2 - 0.06 to 15 kW

## TeSys protection components

### Magnetic motor circuit breakers GV2

Environment			GV2L	GV2LE	GV2ME	GV2P	GV2RT
<b>Circuit breaker type</b>							
Conforming to standards			IEC/EN 60947-4-1, IEC/EN 60947-2				
Product certifications			CSA C22.2 n°60947-4-1 <sup>(1)</sup>				
Climatic withstand			According to IACS E10				
Degree of protection (front face)	Conforming to IEC 60529	Open mounted	Against direct finger contact: IP20				
		In enclosure	IP65 with GV2PC01 GV2PC02 enclosure	-	IP41 with GV2M●01 IP55 with GV2M●02 enclosure	IP 65 with GV2PC01 GV2PC02 enclosure	-
Shock resistance	Conforming to IEC 60068-2-27		30 gn - 11 ms				
Vibration resistance	Conforming to IEC 60068-2-6		5 gn (5 to 150 Hz)				
Ambient air temperature	Storage		°C -40...+80				
	Operation	Open mounted	°C -20...+60				
		In enclosure	°C -20...+40				
Temperature compensation		Open mounted	°C -20...+60				
		In enclosure	°C -20...+40				
Flame resistance	Conforming to IEC 60695-2-11		°C 960				
Maximum operating altitude			m 2000				
Suitable for isolation	Conforming to IEC 60947-1 § 7-1-6		Yes				
Resistance to mechanical impact			J 0.5				
			IK04				
Sensitivity to phase failure			Yes, conforming to IEC 60947-4-1 § 8-2-1-5-2 for GV2ME & GV2P				

Technical characteristics			GV2L	GV2LE	GV2ME	GV2P	GV2RT
<b>Circuit breaker type</b>							
Utilisation category	Conforming to IEC 60947-2		A				
	Conforming to IEC 60947-4-1		AC-3				
Rated operational voltage (Ue)	Conforming to IEC 60947-2	<b>V</b>	690				
Rated insulation voltage (Ui)	Conforming to IEC 60947-2	<b>V</b>	690				
Rated voltage	Conforming to UL 60947-4-1	<b>V</b>	-	-	600	600	600
	CSA C 22.2 n° 60947-4-1		480	480	600	600	600
Rated operational frequency	Conforming to IEC 60947-4-1 UL, CSA	<b>Hz</b>	50/60				
Rated impulse withstand voltage (U imp)	Conforming to IEC 60947-2	<b>kV</b>	6				
Total power dissipated per pole		<b>W</b>	1.8		2.5		
Mechanical durability (C.O.: Closing, Opening)		<b>C.O.</b>	100 000				
Electrical durability for AC-3/415V duty (C.O.: Closing, Opening)	415 V In	<b>C.O.</b>	100 000				
Duty class (maximum operating rate)		<b>C.O./h</b>	40		25		
Maximum conventional rated thermal current (Ith)	Conforming to IEC 60947-4-1	<b>A</b>	0.4...32	0.4...32	0.16...32	0.16...32	0.40...23
Rated duty	Conforming to IEC 60947-4-1		Continuous duty				

(1) GV2L03 to GV2L22, GV2LE03 to GV2LE22.

(2) UL 60947-4-1 type E for GV2P●● (except 32 A).



# Characteristics - TeSys GV2 - 0.06 to 15 kW

## TeSys protection components Magnetic motor circuit breakers GV2

### Mounting characteristics

Operating position  
Without derating, in relation to normal vertical mounting plane <sup>(1)</sup>

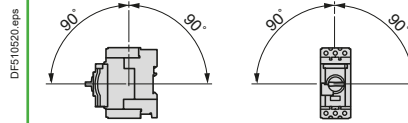

### Products side by side

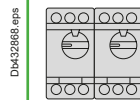

When several products **GV2ME●●**, **GV2P●●**, **GV2RT●●** are mounted side by side, the thermal trip setting  $I_r$  maybe need to be adjusted up to  $1.1 \times I_n$ .

Do not exceed the maximum thermal setting  $I_r$ .

E.g: **GV2ME14**, thermal setting range: 6...10, do not adjust  $I_r$  above 10 A.

### Connection characteristics

#### Connection to screw clamp terminals or spring terminals

Bare cables

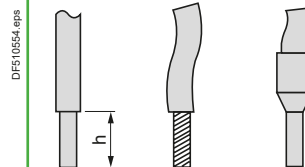

Circuit breaker type			GV2L		GV2LE		GV2ME		GV2P		GV2RT	
Connection to screw clamp terminals (Max. number of conductors x c.s.a.)	Solid cable	mm <sup>2</sup>	Min. 2 x 1	Max. 2 x 6	Min. 2 x 1	Max. 2 x 6	Min. 2 x 1	Max. 2 x 6	Min. 2 x 1	Max. 2 x 6	Min. 2 x 1	Max. 2 x 6
	Flexible cable without cable end	mm <sup>2</sup>	2 x 1.5	2 x 6	2 x 1.5	2 x 6	2 x 1.5	2 x 6	2 x 1.5	2 x 6	2 x 1.5	2 x 6
	Flexible cable with cable end	mm <sup>2</sup>	2 x 1	2 x 4	2 x 1	2 x 4	2 x 1	2 x 4	2 x 1	2 x 4	2 x 1	2 x 4
Tightening torque		N.m	1.7									
Connection to spring terminals Number of conductors x c.s.a.	Solid cable	mm <sup>2</sup>	-	-	-	-	2 x 1 <sup>(2)</sup>	2 x 6	-	-	-	-
	Flexible cable without cable end	mm <sup>2</sup>	-	-	-	-	2 x 1.5 <sup>(2)</sup>	2 x 4	-	-	-	-

#### Connection by bars or lugs

Bars or lugs

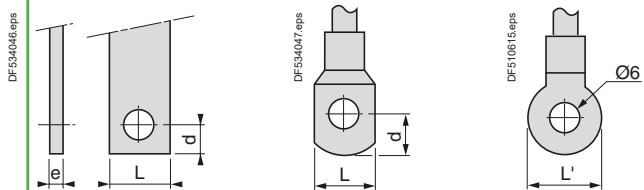

Circuit breaker type			GV2ME●●6	
Pitch	Without spreaders	mm	13.5	
	With spreaders	mm	-	
Bars or cables with lugs	e	mm	≤ 6	
	L	mm	≤ 9.5	
	L'	mm	≤ 9.5	
	d	mm	≤ 10	
Screws			M4	
	Tightening torque	N.m	1.7	
Bare cables (copper or aluminium) with connectors	Height (h)	mm	-	
	C.s.a.	mm <sup>2</sup>	-	
	Tightening torque	N.m	-	

<sup>(1)</sup> When mounting on a vertical rail, fit a stop to prevent any slippage.

<sup>(2)</sup> For cross-sections 1 to 1.5 mm<sup>2</sup>, the use of an **LA9D99** cable end reducer is recommended.

# Characteristics - TeSys GV2 - 0.06 to 15 kW

## TeSys protection components

### Magnetic motor circuit breakers GV2L and GV2LE

Breaking capacity of GV2L and GV2LE																							
Circuit breaker type				GV2LE										GV2L									
				03 to 06	07	08	10	14	16	20	22	32	03 to 05	06 & 07	08	10	14	16	20	22	32		
Rating			<b>A</b>	0.4 to 1.6	2.5	4	6.3	10	14	16	18	25	32	0.4 to 1	1.6 to 2.5	4	6.3	10	14	16	18	25	32
Breaking capacity conforming to IEC 60947-2	230/240 V	Icu	<b>kA</b>	*	*	*	*	*	*	*	*	50	50	*	*	*	*	*	*	*	*	50	50
		Ics % <sup>(1)</sup>		*	*	*	*	*	*	*	*	100	100	*	*	*	*	*	*	*	*	100	100
	400/415 V	Icu	<b>kA</b>	*	*	*	*	*	15	15	15	10	10	*	*	*	*	*	50	50	50	50	50
		Ics % <sup>(1)</sup>		*	*	*	*	*	50	50	40	50	50	*	*	*	*	*	50	50	50	50	50
	440 V	Icu	<b>kA</b>	*	*	*	50	15	8	8	6	6	6	*	*	*	*	*	20	20	20	20	20
		Ics % <sup>(1)</sup>		*	*	*	100	100	50	50	50	50	50	*	*	*	*	*	75	75	75	75	75
	500 V	Icu	<b>kA</b>	*	*	*	50	10	6	6	4	4	4	*	*	*	*	*	10	10	10	10	10
		Ics % <sup>(1)</sup>		*	*	*	100	100	75	75	75	75	75	*	*	*	*	*	100	75	75	75	75
	690 V	Icu	<b>kA</b>	*	3	3	3	3	3	3	3	3	3	*	4	4	4	4	4	4	4	4	4
		Ics % <sup>(1)</sup>		*	75	75	75	75	75	75	75	75	75	*	100	100	100	100	100	100	100	100	100
Associated fuses (if required) if Ics > breaking capacity Icu conforming to IEC 60947-2 amendment 1	230/240 V	aM	<b>A</b>	*	*	*	*	*	*	*	*	80	80	*	*	*	*	*	*	*	*	100	100
		gG	<b>A</b>	*	*	*	*	*	*	*	*	100	100	*	*	*	*	*	*	*	*	125	125
	400/415 V	aM	<b>A</b>	*	*	*	*	*	63	63	80	80	80	*	*	*	*	*	*	80	100	100	100
		gG	<b>A</b>	*	*	*	*	*	80	80	100	100	100	*	*	*	*	*	*	100	125	125	125
	440 V	aM	<b>A</b>	*	*	*	50	50	50	50	63	63	63	*	*	*	*	*	50	63	80	80	80
		gG	<b>A</b>	*	*	*	63	63	63	63	80	80	80	*	*	*	*	*	63	80	100	100	100
	500 V	aM	<b>A</b>	*	*	*	50	50	50	50	50	50	50	*	*	*	*	*	50	50	50	50	50
		gG	<b>A</b>	*	*	*	63	63	63	63	63	63	63	*	*	*	*	*	63	63	63	63	63
	690 V	aM	<b>A</b>	*	16	25	32	32	40	40	40	40	40	*	20	25	40	40	50	50	50	50	50
		gG	<b>A</b>	*	20	32	40	40	50	50	50	50	50	*	25	32	50	50	63	63	63	63	63
Cable protection against thermal stress in the event of short-circuit (PVC insulated copper cables) Minimum c.s.a. protected at 40 °C and at Isc max.	1 mm <sup>2</sup>		<b>kA</b>	●	●	●	≤10	≤6	<sup>(2)</sup>	<sup>(2)</sup>	<sup>(2)</sup>	<sup>(2)</sup>	<sup>(2)</sup>	●	●	●	●	≤10	≤6	<sup>(2)</sup>	<sup>(2)</sup>	<sup>(2)</sup>	<sup>(2)</sup>
	1.5 mm <sup>2</sup>		<b>kA</b>	●	●	●	≤20	≤10	<sup>(2)</sup>	<sup>(2)</sup>	<sup>(2)</sup>	<sup>(2)</sup>	<sup>(2)</sup>	●	●	●	●	≤20	≤10	<sup>(2)</sup>	<sup>(2)</sup>	<sup>(2)</sup>	<sup>(2)</sup>
	2.5 mm <sup>2</sup>			●	●	●	●	●	●	●	●	●	<sup>(2)</sup>	●	●	●	●	●	●	●	●	●	<sup>(2)</sup>
	4...6 mm <sup>2</sup>			●	●	●	●	●	●	●	●	●	●	●	●	●	●	●	●	●	●	●	●

\* > 100 kA.  
 ● Cable c.s.a. protected.  
 (1) As % of Icu.  
 (2) Cable c.s.a. not protected.

Circuit breakers

# Characteristics - TeSys GV2 - 0.06 to 15 kW

## TeSys protection components

### Thermal-magnetic motor circuit breakers GV2ME and GV2P

Breaking capacity of GV2ME, GV2RT and GV2P																							
Circuit breaker type				GV2ME and GV2RT										GV2P									
				01 to 06	07	08	10	14	16	20	21 & 22	32	01 to 06	07	08	10	14	16	20	21 & 22	32		
Rating			A	0.1 to 1.6	2.5	4	6.3	10	14	16	18	23 & 25	32	0.1 to 1.6	2.5	4	6.3	10	14	16	18	23 & 25	32
Breaking capacity conforming to IEC 60947-2	230/240 V	Icu	kA	*	*	*	*	*	*	*	*	50	50	*	*	*	*	*	*	*	*	*	*
		Ics % <sup>(1)</sup>		*	*	*	*	*	*	*	*	100	100	*	*	*	*	*	*	*	*	*	*
	400/415 V	Icu	kA	*	*	*	*	*	15	15	15	10	*	*	*	*	*	*	*	50	50	50	50
		Ics % <sup>(1)</sup>		*	*	*	*	*	50	50	40	50	*	*	*	*	*	*	*	50	50	50	50
	440 V	Icu	kA	*	*	*	50	15	8	8	6	6	*	*	*	*	*	*	50	20	20	20	20
		Ics % <sup>(1)</sup>		*	*	*	100	100	50	50	50	50	*	*	*	*	*	*	75	75	75	75	75
	500 V	Icu	kA	*	*	*	50	10	6	6	4	4	*	*	*	*	*	50	42	10	10	10	10
		Ics % <sup>(1)</sup>		*	*	*	100	100	75	75	75	75	*	*	*	*	*	100	75	75	75	75	75
	690 V	Icu	kA	*	3	3	3	3	3	3	3	3	*	8	8	6	6	6	6	4	4	4	4
		Ics % <sup>(1)</sup>		*	75	75	75	75	75	75	75	75	*	100	100	100	100	100	100	100	100	100	100
Associated fuses (if required) if Ics > breaking capacity Icu conforming to IEC 60947-2	230/240 V	aM	A	*	*	*	*	*	*	*	*	80	80	*	*	*	*	*	*	*	*	*	*
		gG	A	*	*	*	*	*	*	*	*	100	100	*	*	*	*	*	*	*	*	*	*
	400/415 V	aM	A	*	*	*	*	*	63	63	80	80	*	*	*	*	*	*	*	100	100	100	100
		gG	A	*	*	*	*	*	80	80	100	100	*	*	*	*	*	*	*	125	125	125	125
	440 V	aM	A	*	*	*	50	50	50	50	63	63	*	*	*	*	*	*	50	63	80	80	80
		gG	A	*	*	*	63	63	63	63	80	80	*	*	*	*	*	*	63	80	100	100	100
	500 V	aM	A	*	*	*	50	50	50	50	50	50	*	*	*	*	*	50	50	50	50	50	50
		gG	A	*	*	*	63	63	63	63	63	63	*	*	*	*	*	63	63	63	63	63	63
	690 V	aM	A	*	16	25	32	32	40	40	40	40	*	20	25	40	40	50	50	50	50	50	50
		gG	A	*	20	32	40	40	50	50	50	50	*	25	32	50	50	63	63	63	63	63	63

\* > 100 kA.  
 (1) As % of Icu.

Circuit breakers

# Characteristics - TeSys GV2 - 0.06 to 15 kW

## TeSys protection components

### Thermal-magnetic motor circuit breakers GV2ME and GV2P

Breaking capacity of GV2ME, GV2RT and GV2P (used in association with current limiter GV1L3)													
Circuit breaker type			GV2ME and GV2RT										
Rating	A		01 to 06 0.1 to 1.6	07 2.5	08 4	10 6.3	14 10	16 14	20 18	21 23	22 25	32 32	
Breaking capacity conforming to IEC 60947-2	230/240 V	Icu	kA	*	*	*	*	*	*	*	*	*	
		Ics % <sup>(1)</sup>		*	*	*	*	*	*	*	*	*	
	400/415 V	Icu	kA	*	*	*	*	*	100	100	100	100	
		Ics % <sup>(1)</sup>		*	*	*	*	*	50	50	40	40	40
	440 V	Icu	kA	*	*	*	*	*	50	20	20	20	
		Ics % <sup>(1)</sup>		*	*	*	*	*	75	75	75	75	75
	500 V	Icu	kA	*	*	*	*	50	42	10	10	10	
		Ics % <sup>(1)</sup>		*	*	*	*	100	100	75	75	75	75
Circuit breaker type			GV2P										
Rating	A		01 to 06 0.1 to 1.6	07 2.5	08 4	10 6.3	14 10	16 14	20 18	21 23	22 25	32 32	
Breaking capacity conforming to IEC 60947-2	230/240 V	Icu	kA	*	*	*	*	*	*	*	*	*	
		Ics % <sup>(1)</sup>		*	*	*	*	*	*	*	*	*	
	400/415 V	Icu	kA	*	*	*	*	*	*	*	*	*	
		Ics % <sup>(1)</sup>		*	*	*	*	*	*	*	*	*	
	440 V	Icu	kA	*	*	*	*	*	100	100	100	100	
		Ics % <sup>(1)</sup>		*	*	*	*	*	50	50	50	50	50
	500 V	Icu	kA	*	*	*	*	100	100	100	100	100	
		Ics % <sup>(1)</sup>		*	*	*	*	50	50	50	50	50	50
	690 V <sup>(3)</sup>	Icu = Ics	kA	*	50	50	50	50	50	50	50	50	
Circuit breaker type			GV2ME										
Rating	A		01 to 06 0.1 to 1.6	07 2.5	08 4	10 6.3	14 10	16 14	20 18	21 23	22 25	32 32	
Cable protection against thermal stress in the event of short-circuit (PVC insulated copper cables)	Minimum c.s.a. protected at 40 °C at Isc max.	1 mm <sup>2</sup>		●	●	●	≤ 10 kA	≤ 6 kA	<sup>(2)</sup>	<sup>(2)</sup>	<sup>(2)</sup>	<sup>(2)</sup>	
		1.5 mm <sup>2</sup>		●	●	●	≤ 20 kA	≤ 10 kA	<sup>(2)</sup>	<sup>(2)</sup>	<sup>(2)</sup>	<sup>(2)</sup>	
		2.5 mm <sup>2</sup>		●	●	●	●	●	●	●	●	●	<sup>(2)</sup>
		4...6 mm <sup>2</sup>		●	●	●	●	●	●	●	●	●	●

\* > 100 kA.  
 ● Cable c.s.a. protected.  
 (1) As % of Icu.  
 (2) Cable c.s.a. not protected.  
 (3) With limiter LA9LB920.

# TeSys protection components

Magnetic motor circuit breakers GV2L and GV2LE

## Tripping curves for GV2L or LE combined with thermal overload relay LRD or LR2K

Average operating times at 20 °C related to multiples of the setting current

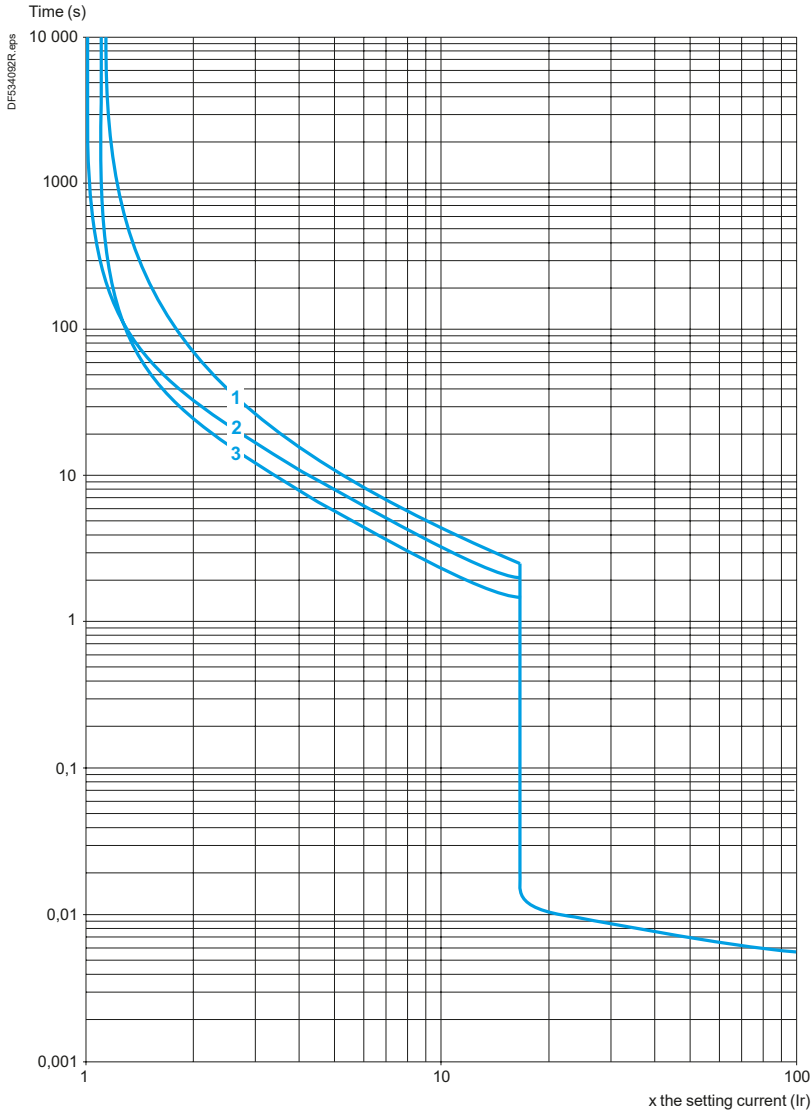

- 1 3 poles from cold state
- 2 2 poles from cold state
- 3 3 poles from hot state

Circuit breakers

## Curves - TeSys GV2 - 0.06 to 15 kW

### TeSys protection components

#### Magnetic motor circuit breakers GV2L and GV2LE

#### Current limitation on short-circuit for GV2L and GV2LE only (3-phase 400/415 V)

##### Dynamic stress

$I_{peak} = f(\text{prospective } I_{sc}) \text{ at } 1.05 U_e = 435 \text{ V}$

Limited peak current (kA)

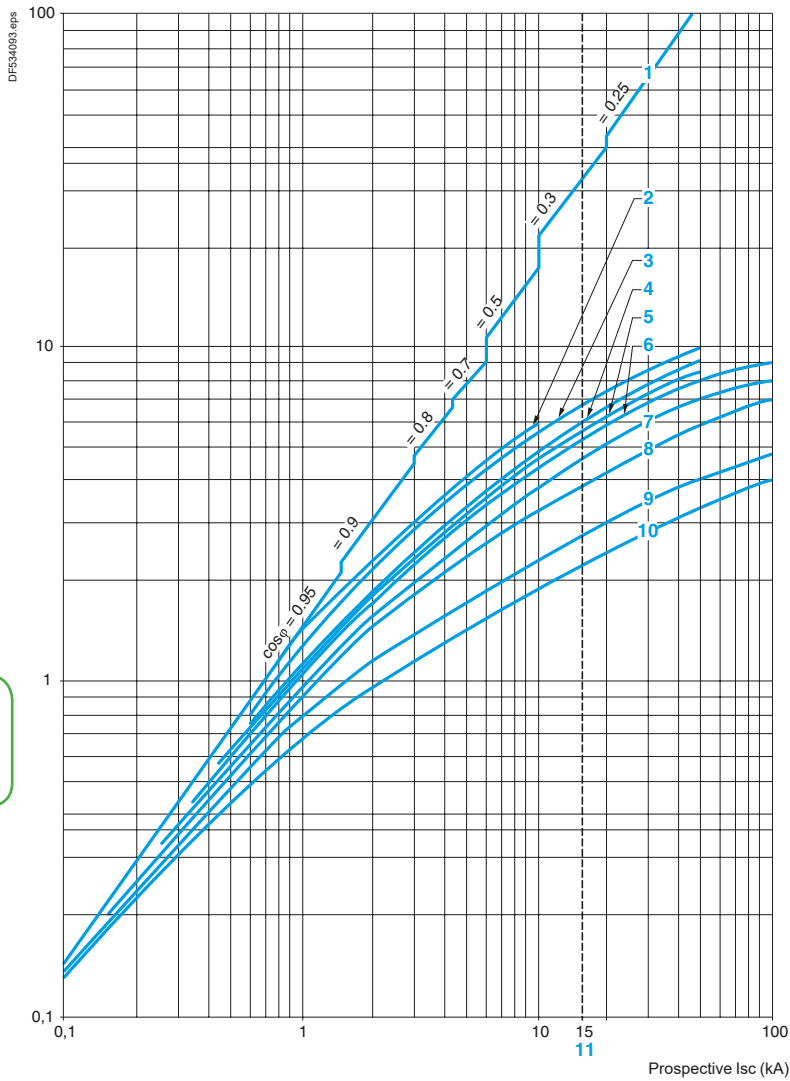

1 Maximum peak current

2 32 A

3 25 A

4 18 A

5 14 A

6 10 A

7 6.3 A

8 4 A

9 2.5 A

10 1.6 A

11 Limit of rated ultimate breaking capacity on short-circuit of GV2LE (14, 18, 23 and 25 A ratings).

## Curves - TeSys GV2 - 0.06 to 15 kW

### TeSys protection components

#### Magnetic motor circuit breakers GV2L and GV2LE

#### Current limitation on short-circuit for GV2L and GV2LE + thermal overload relay LRD or LR2K (3-phase 400/415 V)

##### Dynamic stress

$I_{peak} = f(\text{prospective } I_{sc}) \text{ at } 1.05 U_e = 435 \text{ V}$

Limited peak current (kA)

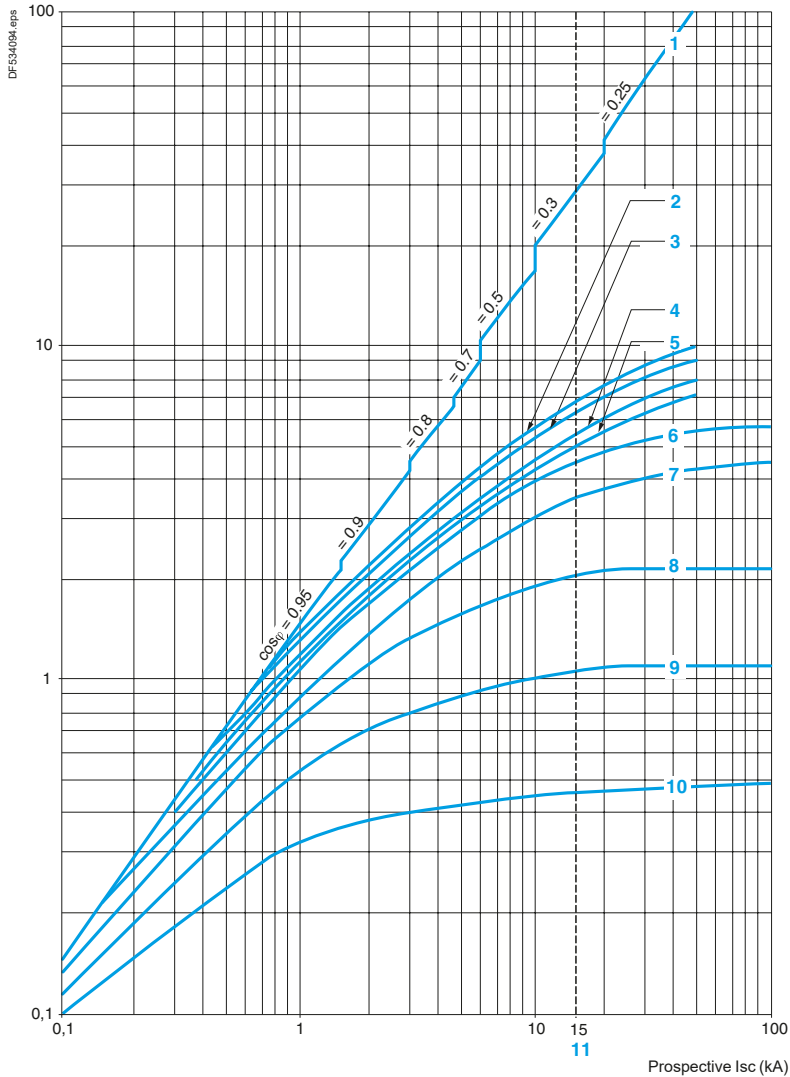

1 Maximum peak current

2 32 A

3 25 A

4 18 A

5 14 A

6 10 A

7 6.3 A

8 4 A

9 2.5 A

10 1.6 A

11 Limit of rated ultimate breaking capacity on short-circuit of GV2LE (14, 18, 23 and 25 A ratings).

# Curves - TeSys GV2 - 0.06 to 15 kW

## TeSys protection components

### Magnetic motor circuit breakers GV2LE

#### Thermal limit on short-circuit for GV2LE only

#### Thermal limit in kA<sup>2</sup>s in the magnetic operating zone

Sum of  $I^2dt = f$  (prospective  $I_{sc}$ ) at 1.05  $U_e = 435$  V

Sum of  $I^2dt$  (kA<sup>2</sup>s)

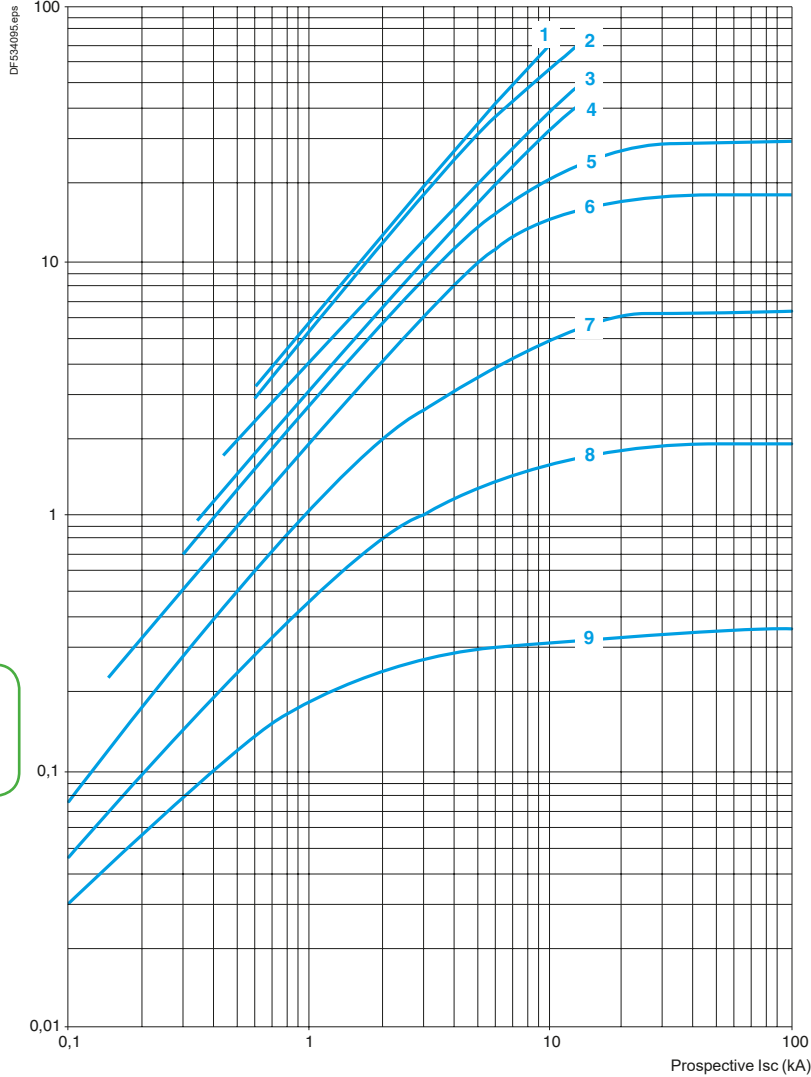

- 1 32 A
- 2 25 A
- 3 18 A
- 4 14 A
- 5 10 A
- 6 6.3 A
- 7 4 A
- 8 2.5 A
- 9 1.6 A



# Curves - TeSys GV2 - 0.06 to 15 kW

## TeSys protection components

### Magnetic motor circuit breakers GV2L

#### Thermal limit on short-circuit for GV2L only

#### Thermal limit in kA<sup>2</sup>s in the magnetic operating zone

Sum of  $I^2dt = f$  (prospective  $I_{sc}$ ) at 1.05  $U_e = 435$  V

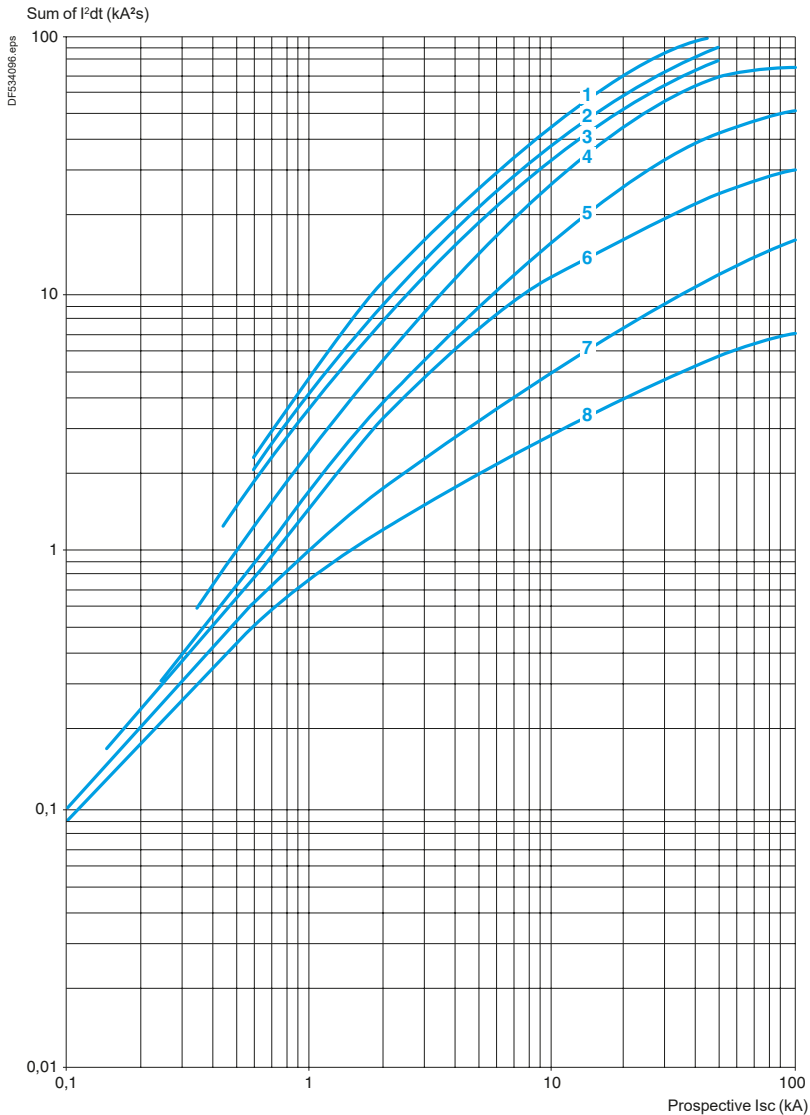

- 1 25 A and 32 A
- 2 18 A
- 3 14 A
- 4 10 A
- 5 6.3 A
- 6 4 A
- 7 2.5 A
- 8 1.6 A

## Curves - TeSys GV2 - 0.06 to 15 kW

### TeSys protection components

#### Magnetic motor circuit breakers GV2L and GV2LE

#### Thermal limit on short-circuit for GV2L and GV2LE + thermal overload relay LRD or LR2K

##### Thermal limit in kA<sup>2</sup>s in the magnetic operating zone

Sum of  $I^2dt = f$  (prospective  $I_{sc}$ ) at 1.05  $U_e = 435$  V

Sum of  $I^2dt$  (kA<sup>2</sup>s)

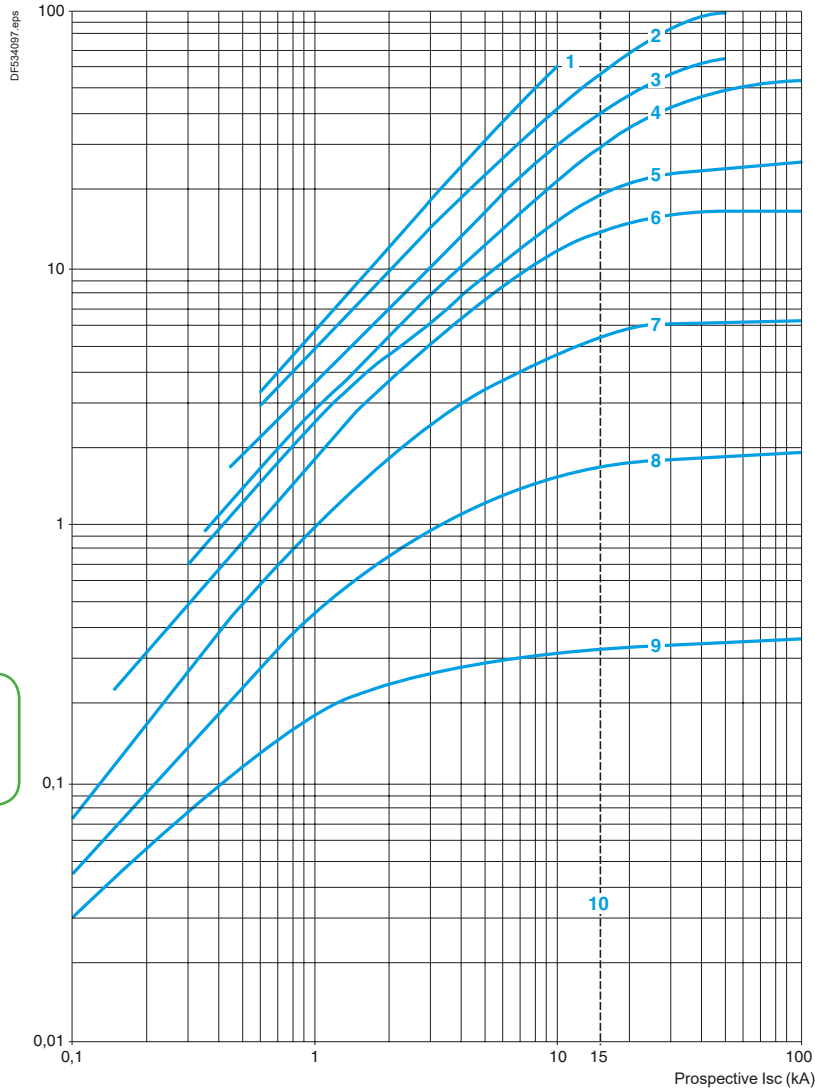

- 1 32 A (GV2LE32)
- 2 25 A and 32 A (GV2L32)
- 3 18 A
- 4 14 A
- 5 10 A
- 6 6.3 A
- 7 4 A
- 8 2.5 A
- 9 1.6 A
- 10 Limit of rated ultimate breaking capacity on short-circuit of GV2 LE (14, 18, 23 and 25 A ratings).

# TeSys protection components

Thermal-magnetic motor circuit breakers GV2ME and GV2P

## Thermal-magnetic tripping curves for GV2ME, GV2RT and GV2P

Average operating times at 20 °C related to multiples of the setting current

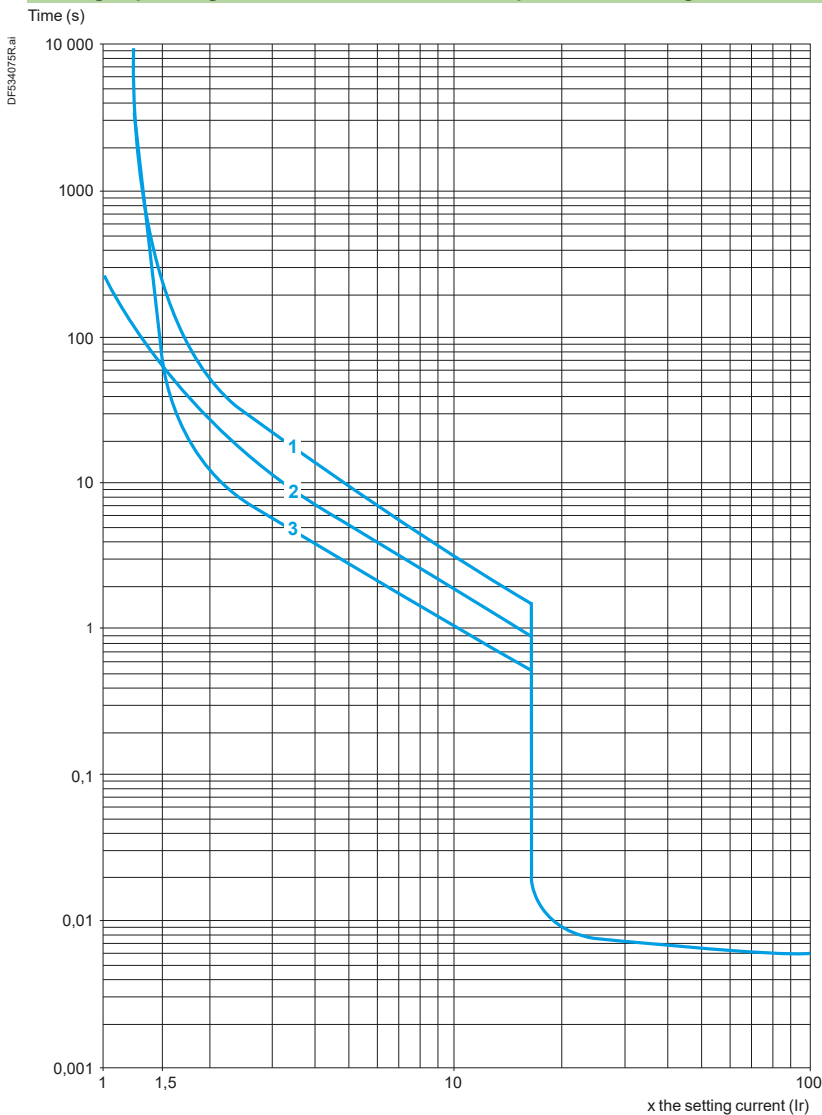

- 1 3 poles from cold state
- 2 2 poles from cold state
- 3 3 poles from hot state

Circuit breakers

## Curves - TeSys GV2 - 0.06 to 15 kW

### TeSys protection components

Thermal-magnetic motor circuit breakers GV2ME and GV2P

#### Current limitation on short-circuit for GV2ME, GV2RT and GV2P (3-phase 400/415 V)

##### Dynamic stress

$I_{peak} = f(\text{prospective } I_{sc}) \text{ at } 1.05 U_e = 435 \text{ V}$

Limited peak current (kA)

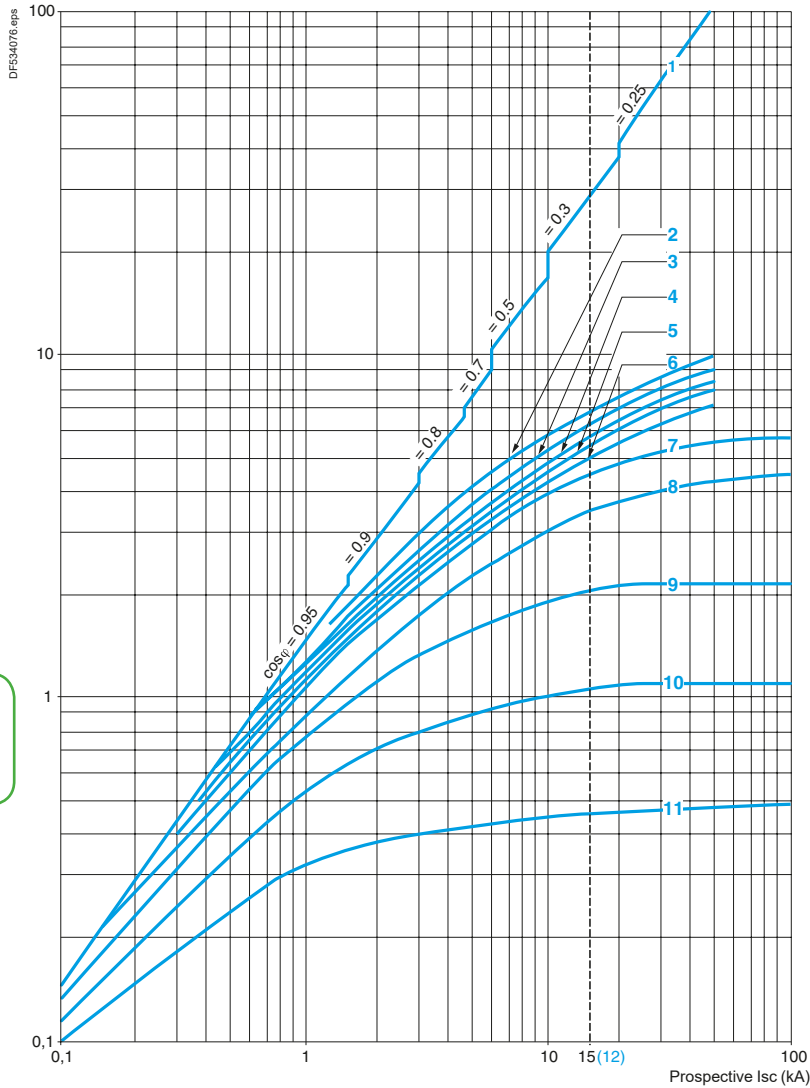

1 Maximum peak current

2 24 - 32 A

3 20 - 25 A

4 17 - 23 A

5 13 - 18 A

6 9 - 14 A

7 6 - 10 A

8 4 - 6.3 A

9 2.5 - 4 A

10 1.6 - 2.5 A

11 1 - 1.6 A

12 Limit of rated ultimate breaking capacity on short-circuit of GV2ME (14, 18, 23 and 25 A ratings)

# TeSys protection components

Thermal-magnetic motor circuit breakers GV2ME and GV2RT

## Thermal limit on short-circuit for GV2ME and GV2RT

### Thermal limit in kA<sup>2</sup>s in the magnetic operating zone

Sum of I<sup>2</sup>dt = f (prospective I<sub>sc</sub>) at 1.05 U<sub>e</sub> = 435 V

Sum of I<sup>2</sup>dt (kA<sup>2</sup>s)

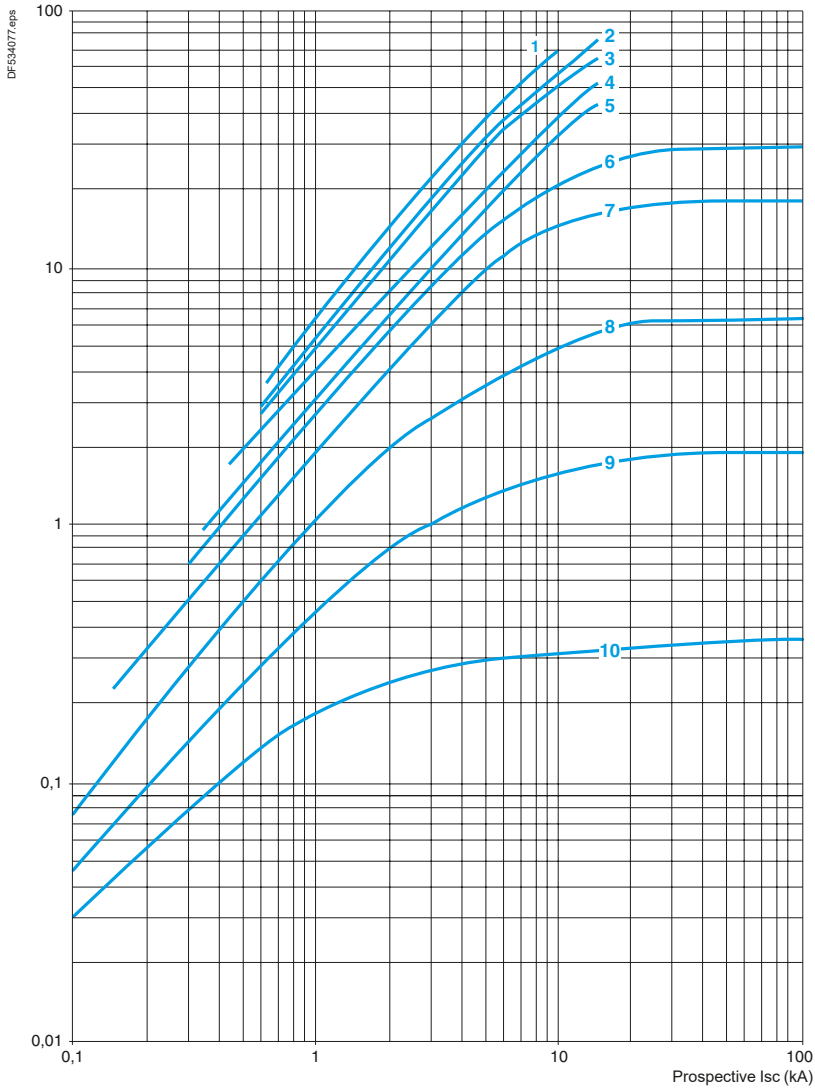

- 1 24 - 32 A
- 2 20 - 25 A
- 3 17 - 23 A
- 4 13 - 18 A
- 5 9 - 14 A
- 6 6 - 10 A
- 7 4 - 6.3 A
- 8 2.5 - 4 A
- 9 1.6 - 2.5 A
- 10 1 - 1.6 A

Circuit breakers

## Curves - TeSys GV2 - 0.06 to 15 kW

### TeSys protection components

#### Thermal-magnetic motor circuit breakers GV2P

#### Thermal limit on short-circuit for GV2P

##### Thermal limit in $\text{kA}^2\text{s}$ in the magnetic operating zone

Sum of  $I^2dt = f$  (prospective  $I_{sc}$ ) at  $1.05 U_e = 435 \text{ V}$

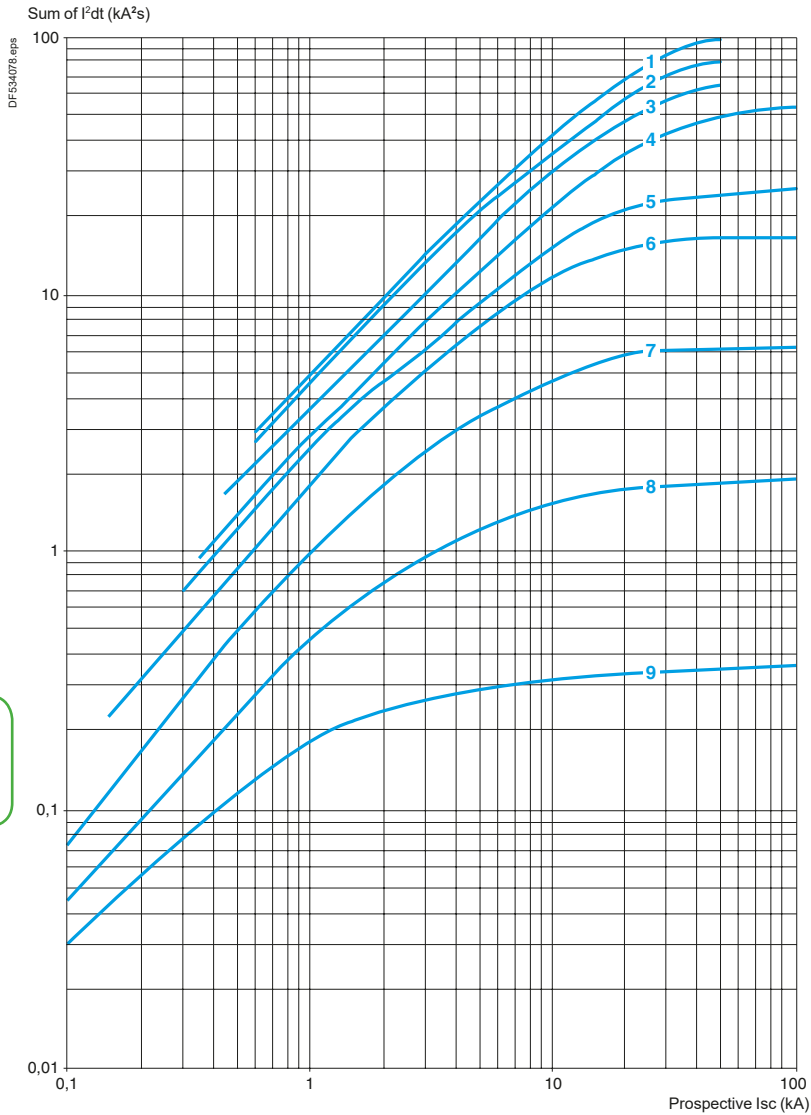

- 1 20 - 25 A, 24 - 32 A
- 2 17 - 23 A
- 3 13 - 18 A
- 4 9 - 14 A
- 5 6 - 10 A
- 6 4 - 6.3 A
- 7 2.5 - 4 A
- 8 1.6 - 2.5 A
- 9 1 - 1.6 A

## TeSys protection components

### GV2 motor circuit breakers

#### Electric trips

Characteristics of GV2 electric trips					
Type of trip			GVAU●●● MN undervoltage trip	GVAX●●● MN undervoltage trip for GV2 mE - safety device for dangerous machines	GVAS●●● MX shunt trip
Rated insulation voltage (Ui)	Conforming to IEC 60947-1	V	690	500	690
	Conforming to UL 60947-4-1, CSA C22.2 n° 60947-4-1	V	600	-	600
Operational voltage (Ue)	Conforming to IEC 60947-1	V	0.85...1.1 Uc	0.85...1.1 Uc	0.7...1.1 Uc
Drop-out voltage		V	0.7...0.35 Uc	0.7...0.35 Uc	0.75...0.2 Uc
Inrush consumption	~ ≡≡≡	VA	12	12	14
Sealed consumption	~ ≡≡≡	VA	3.5	3.5	5
Operating time	Conforming to IEC 60947-1	ms	From the moment the voltage reaches its operational value until opening of the circuit breaker. 10...15		
On-load factor			100 %		
Cabling (spring connection)	Number of conductors		2 or 4		
	Solid cable	mm <sup>2</sup>	1...2.5		
	Flexible cable without cable end	mm <sup>2</sup> AWG	0.75...2.5		
	Flexible cable with cable end	mm <sup>2</sup>	0.75...2.5		
Tightening torque		N.m	1.4 max		
Mechanical durability (C.O.: Close - Open)		C.O.	30000 (GV2ME and GV2P)		

# TeSys protection components

## Thermal-magnetic motor circuit breakers GV2

### Auxiliary contacts

Type of contacts			Instantaneous auxiliary GVAN, GVAD							Fault signalling GVAD, GVAM11 <sup>(1)</sup>				Instantaneous auxiliary GVAE			
Rated insulation voltage (Ui) (associated insulation coordination)	Conforming to IEC 60947-1	<b>V</b>	690							690				250 (690 in relation to main circuit)			
	Conforming to UL 60947-4-1, CSA C22.2 n° 60947-4-1	<b>V</b>	600							300				300			
Conventional thermal current (Ith)	Conforming to IEC 60947-5-1	<b>A</b>	6							2.5				2.5			
	Conforming to UL 60947-5-1, CSA C22.2 n° 60947-5-1	<b>A</b>	5							1				1			
Mechanical durability (C.O.: Close - Open)		<b>C.O.</b>	100 000							1000				100 000			
Operational power and current conforming to IEC 60947-5-1. a.c. operation			AC-15/100 000 C.O.							AC-14/1000 C.O.				AC-15/100 000 C.O.			
	<b>Rated operational voltage (Ue)</b>	<b>V</b>	<b>48</b>	<b>110</b>	<b>230</b>	<b>380</b>	<b>440</b>	<b>500</b>	<b>690</b>	<b>24</b>	<b>48</b>	<b>110</b>	<b>230</b>	<b>24</b>	<b>48</b>	<b>110</b>	<b>230</b>
Operation	Operational power, normal conditions	<b>VA</b>	300	500	720	850	650	500	400	36	48	72	72	48	60	120	120
	Occasional breaking and making capacities, abnormal conditions	<b>kVA</b>	3	7	13	15	13	12	9	0.22	0.3	0.45	0.45	0.48	0.6	1.27	2.4
	Rated operational current (Ie)	<b>A</b>	6	4.5	3.3	2.2	1.5	1	0.6	1.5	1	0.5	0.3	2	1.25	1	0.5
Operational power and current conforming to IEC 60947-5-1. d.c.			DC-13/100 000 C.O.							DC-13/1000 C.O.				DC-13/100 000 C.O.			
	<b>Rated operational voltage (Ue)</b>	<b>V</b>	<b>24</b>	<b>48</b>	<b>60</b>	<b>110</b>	<b>240</b>	–	–	<b>24</b>	<b>48</b>	<b>60</b>	–	<b>24</b>	<b>48</b>	<b>60</b>	–
Operation	Operational power, normal conditions	<b>W</b>	140	240	180	140	120	–	–	24	15	9	–	24	15	9	–
	Occasional breaking and making capacities, abnormal conditions	<b>W</b>	240	360	240	210	180	–	–	100	50	50	–	100	50	50	–
	Rated operational current (Ie)	<b>A</b>	6	5	3	1.3	0.5	–	–	1	0.3	0.15	–	1	0.3	0.15	–
Low power switching reliability of contact			<b>GV AE:</b> Number of failures for "n" million operating cycles (17 V-5 mA): = 10 <sup>-6</sup>														
Minimum operational conditions d.c. operation		<b>V</b>	17														
		<b>mA</b>	5														
Short-circuit protection			By <b>GB2 CB●●</b> circuit breaker (rating according to operational current for Ue ≤ 415 V) or by gG fuse 10 A max										<b>GB2 CB06</b> or gG fuse 10 A max				
Cabling, screw clamp terminals	Number of conductors		<b>1</b>			<b>2</b>											
	Solid cable	<b>mm<sup>2</sup></b>	1...2.5			1...2.5											
	Flexible cable without cable end	<b>mm<sup>2</sup></b>	0.75...2.5			0.75...2.5											
	Flexible cable with cable end	<b>mm<sup>2</sup></b>	0.75...1.5			0.75...1.5											
	Tightening torque	<b>N.m</b>	1.4 max			1.4 max											
Cabling, spring terminal connections	Flexible cable without cable end	<b>mm<sup>2</sup></b>	GVAN only 0.75...2.5			0.75...2.5			–				0.75...1.5				

Circuit breakers

#### Operation of instantaneous auxiliary contacts

##### GV2

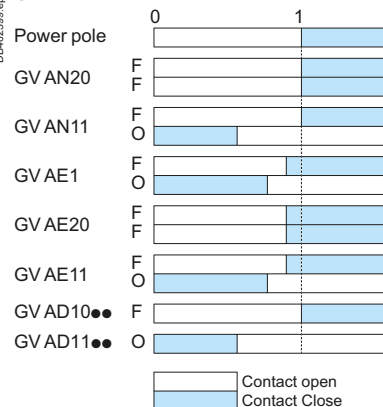

(1) For application example of fault signalling contact and short-circuit signalling contact.  
 (2) Add an RC circuit type **LA4 D** to the load terminals.

#### Operation of fault signalling contacts

##### GVAM11

Change of state following tripping on short-circuit.

##### GVAD10●● and GVAD01●●

Change of state following tripping on short-circuit, overload or undervoltage.



## Characteristics - TeSys GV2 - 0.06 to 15 kW

### TeSys protection components

Thermal-magnetic and magnetic motor circuit breakers GV2

Accessories

Characteristics of 3-pole busbars GV2G●●●						
Rated insulation voltage (Ui)	Conforming to IEC 60947-1	<b>V</b>	<b>GV2G●●●</b> 690			
Conventional thermal current (Ith)	Conforming to IEC 60439-1	<b>A</b>	63			
Rated operational current (Ie)		<b>A</b>	63			
Permissible peak current (I peak)		<b>kA</b>	11			
Permissible thermal limit (I <sup>2</sup> t)		<b>kA<sup>2</sup>s</b>	104			
Degree of protection	Conforming to IEC 60529		IP 20			
Terminal block			Yes			
Characteristics of terminal blocks GV2G05 and GV1G09 (for GV2ME and GV2P)						
Rated insulation voltage (Ui)	Conforming to IEC 60947-1	<b>V</b>	690			
Conventional thermal current (Ith)	Conforming to IEC 60439-1	<b>A</b>	63			
Rated operational current (Ie)		<b>A</b>	63 115			
Degree of protection	Conforming to IEC 60529		IP 20			
Connection	Solid cable	<b>mm<sup>2</sup></b>	1 x 1.5 to 25 conductor or 2 x 1.5 to 6 conductors			
	Flexible cable without cable end	<b>mm<sup>2</sup></b>	1 x 1.5 to 16 conductor or 2 x 1.5 to 4 conductors			
	Flexible cable with cable end	<b>mm<sup>2</sup></b>	1 x 1.5 to 10 conductor or 2 x 1.5 to 2 conductors			
	Flexible or solid cable AWG		1 AWG 4			
Tightening torque	Connector	<b>N.m</b>	2.2			
	Screw clamp terminals	<b>N.m</b>	1.7			
Characteristics of current limiters (GV2ME and GV2P)						
<b>Type</b>			<b>GV1L3</b>	<b>LA9LB920</b>		
Rated insulation voltage (Ui)	Conforming to IEC 60947-1	<b>V</b>	690	690		
Conventional thermal current (Ith)	Conforming to IEC 60947-1	<b>A</b>	63	63		
Rated operational current (Ie)		<b>A</b>	32	32		
Operating threshold	rms current	<b>A</b>	1500 (non adjustable threshold)	1000 (non adjustable threshold)		
Connection			<b>1 conductor</b>	<b>2 conductors</b>	<b>1 conductor</b>	<b>2 conductors</b>
	Solid cable	<b>mm<sup>2</sup></b>	1.5...25	1.5...10	1.5...25	1.5...10
	Flexible cable without cable end	<b>mm<sup>2</sup></b>	1.5...25	2.5...10	1.5...25	1.5...10
	Flexible cable with cable end	<b>mm<sup>2</sup></b>	1.5...16	1.5... 4	1.5...16	1.5... 4
Tightening torque		<b>N.m</b>	2.2			

# Dimensions, mounting - TeSys GV2 - 0.06 to 15 kW

## TeSys protection components

### Magnetic motor circuit breakers GV2L and GV2LE

#### GV2L

##### Dimensions

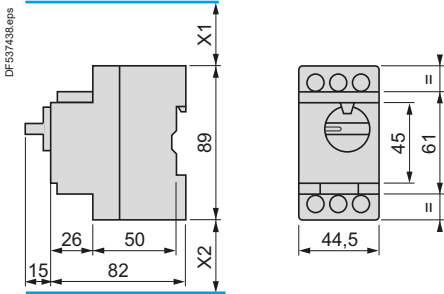

X1 Electrical clearance = 40 mm for  $U_e \leq 415$  V, or 80 mm for  $U_e = 440$  V, or 120 mm for  $U_e = 500$  and 690 V.  
X2 = 40 mm.

##### GVAD, AM, AN, AU, AS

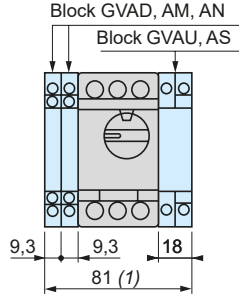

(1) Maximum.

##### GV2AK00

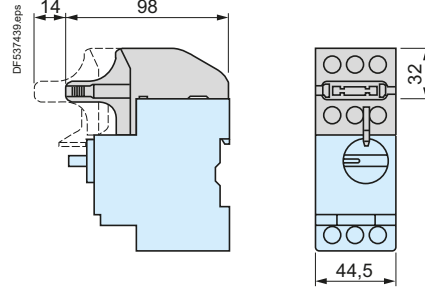

##### Mounting

On rail AM1 DE200, AM1 ED200 (35 x 15)

Panel mounted

On pre-slotted mounting plate AM1 PA

##### Adapter plate GK2AF01

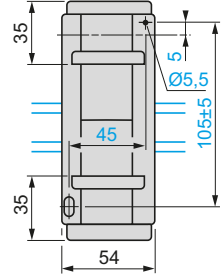
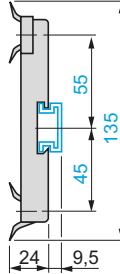
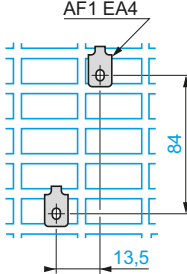
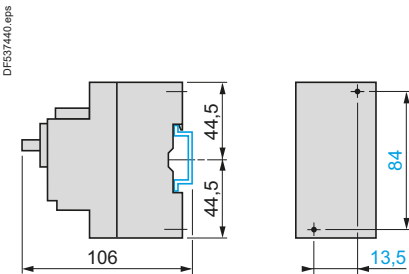

##### 7.5 mm height compensation plate GV1F03



Circuit breakers

#### GV2LE

##### Dimensions

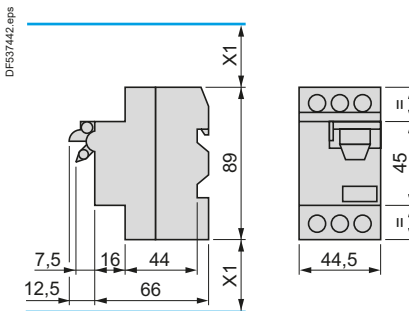

X1 Electrical clearance = 40 mm for  $U_e \leq 690$  V.

##### GVAD, AM, AN, AU, AS

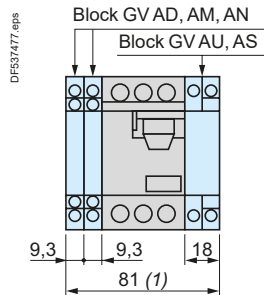

(1) Maximum.

##### GVAE

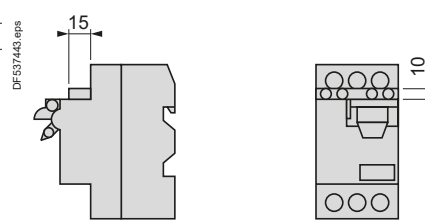

##### Mounting

On 35 mm rail

On panel with adapter plate GV2 AF02

On pre-slotted plate AM1 PA

On rails DZ5 MB201

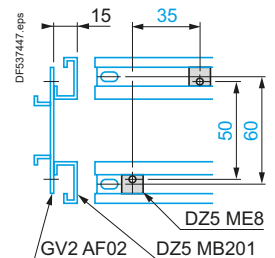
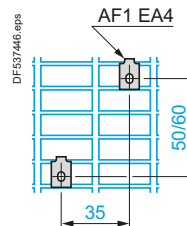
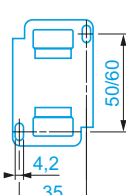
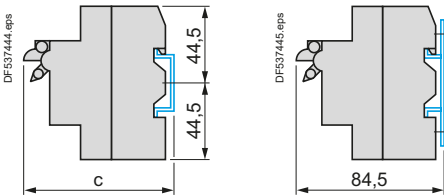

c = 80 on AM1 DP200 (35 x 7.5) and 88 on AM1 DE200, ED200 (35 x 15)

TeSys protection components

Magnetic motor circuit breakers GV2L and GV2LE

Mounting

Mounting of external operator GV2APN01, GV2APN02 or GV2APN04 for motor circuit breakers GV2L

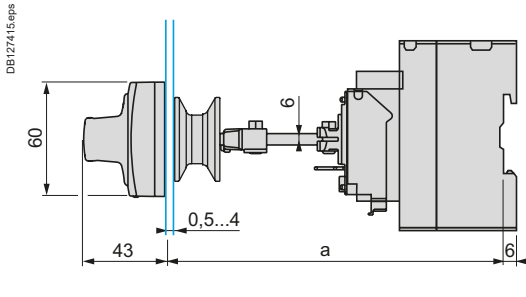

Door cut-out

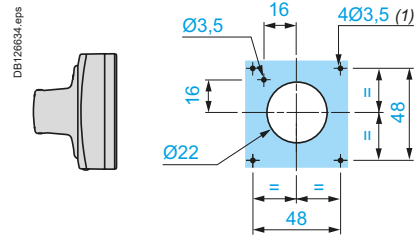

(1) For IP65 only.

Mounting of external operator GVAPH02 for motor circuit breakers GV2L

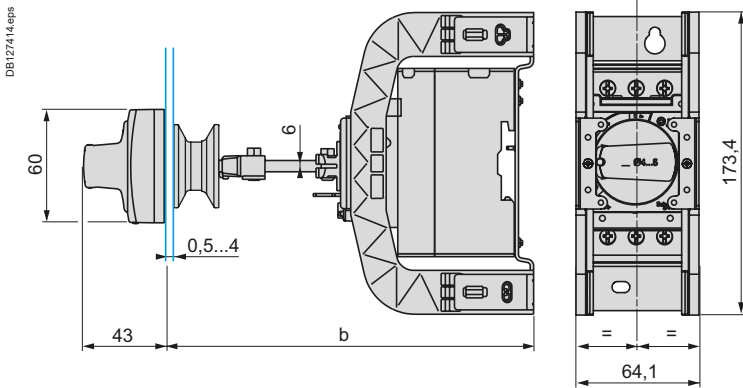

Door cut-out

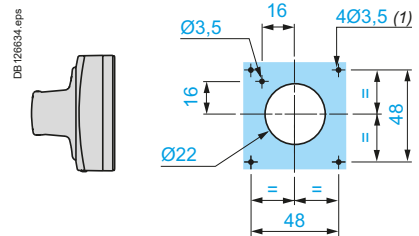

(1) For IP65 only.

	a		b	
	Mini	Maxi	Mini	Maxi
GV2 APN●●	140	250		
GV2 APN●● + GV APH02			151	250
GV2 APN●● + GV APK11	250	434	-	-
GV2 APN●● + GV APH02 + GV APK11	-	-	250	445

Mounting of external operator GV2AP03 for GV2LE

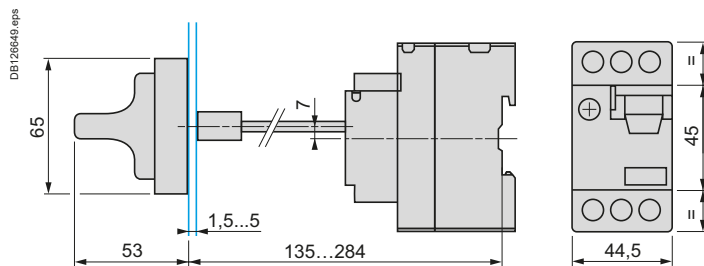

Door cut-out

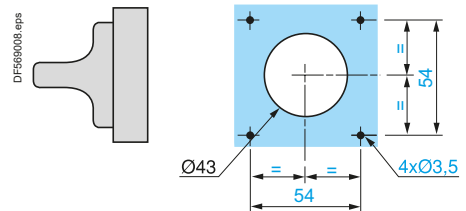

# Dimensions, mounting - TeSys GV2 - 0.06 to 15 kW

## TeSys protection components

### Magnetic motor circuit breakers GV2L and GV2LE

#### GV2LE

##### Sets of busbars GV2G445, GV2G454, GV2G472, with terminal block GV2G05

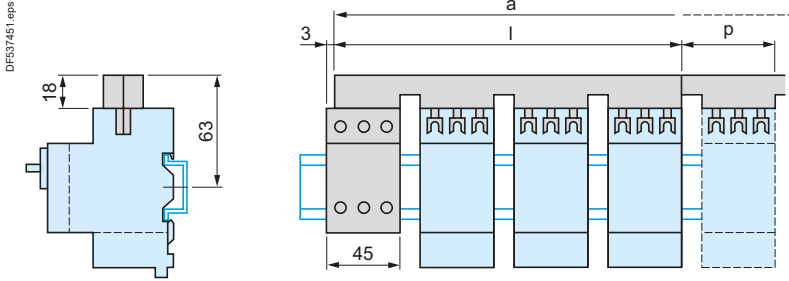

	l	p
GV2G445 (4 x 45 mm)	179	45
GV2G454 (4 x 54 mm)	206	54
GV2G472 (4 x 72 mm)	260	72

Number of tap-offs	a			
	5	6	7	8
GV2G445	224	269	314	359
GV2G454	260	314	368	422
GV2G472	332	404	476	548

#### Sets of busbars GV2LE

##### Sets of busbars GV2G●●● with term. block GV1G09

##### Sets of busbars GV2G245, GV2G254, GV2GR272

Circuit breakers

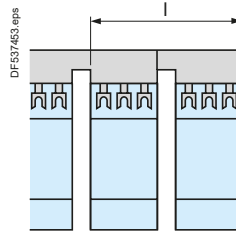
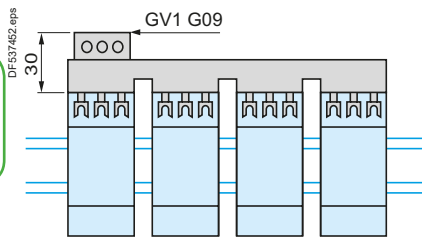

	l
GV2G245 (2 x 45 mm)	89
GV2G254 (2 x 54 mm)	98
GV2G272 (2 x 72 mm)	116

#### Set of busbars GV2G554

#### Sets of busbars GV2G345 and GV2G354

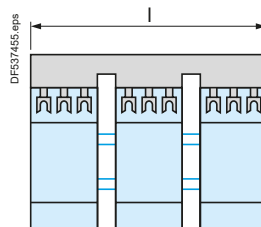
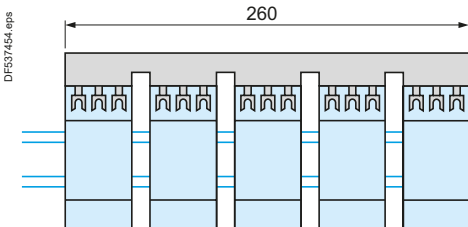

	l
GV2G345 (3 x 45 mm)	134
GV2G354 (3 x 54 mm)	152

# Dimensions, mounting - TeSys GV2 - 0.06 to 15 kW

## TeSys protection components

### Magnetic motor circuit breakers GV2ME and GV2P

#### Dimensions

##### GV2ME

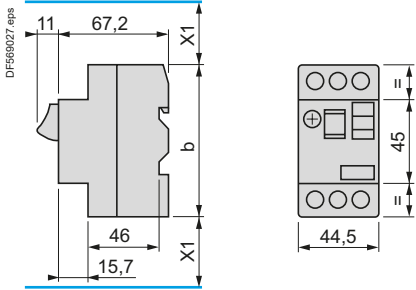

##### GVAX

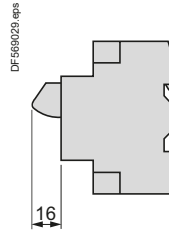

##### GVAD, AM, AN, AU, AS, AX

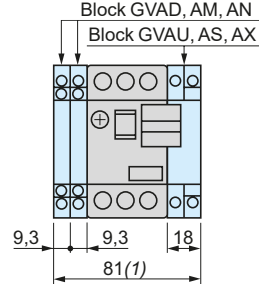

##### GVAE

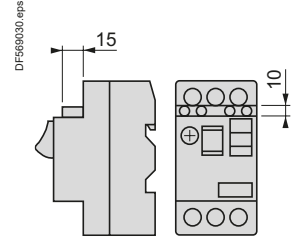

**b**

GV2ME●●	89
GV2ME●●3	101

(1) Maximum.

X1 Electrical clearance = 40 mm for  $U_e \leq 690$  V

##### GV2P

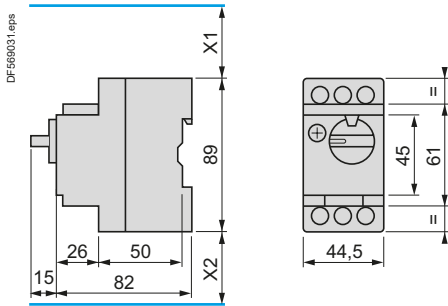

##### GVAD, AM, AN, AU, AS

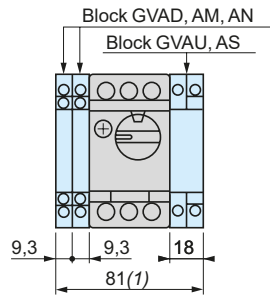

##### GV2AK00

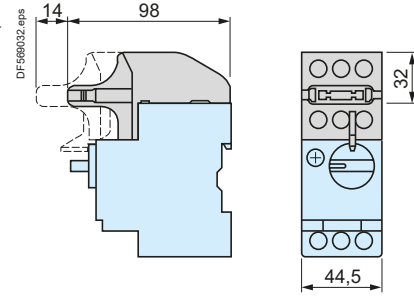

(1) Maximum.

X1 Electrical clearance = 40 mm for  $U_e \leq 415$  V, or 80 mm for  $U_e = 440$  V, or 120 mm for  $U_e = 500$  and 690 V

X2 = 40 mm

##### GV2GH7

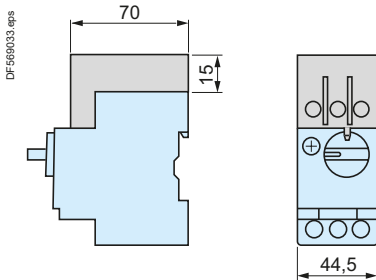

# Dimensions, mounting - TeSys GV2 - 0.06 to 15 kW

## TeSys protection components

Thermal-magnetic motor circuit breakers GV2ME and GV2P

### Mounting

#### GV2ME

On 35 mm rail

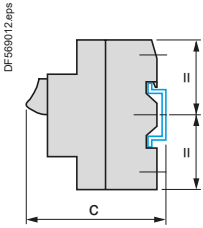

On panel with adapter plate GV2AF02

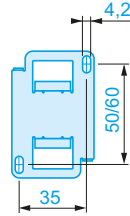
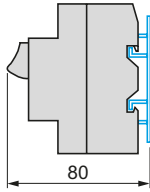

On pre-slotted plate AM1 PA

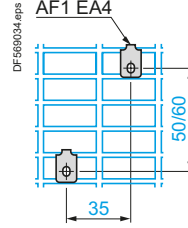

On rails DZ5 MB201

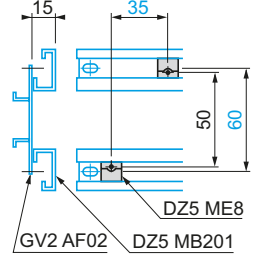

$c = 78.5$  on AM1 DP200 (35 x 7.5)  
 $c = 86$  on AM1 DE200, ED200 (35 x 15)

#### GV2P

On rail AM1 DE200, ED200 (35 x 15)

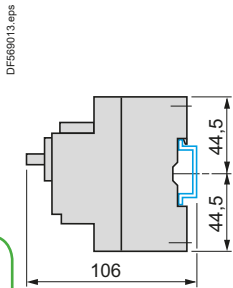

Panel mounted

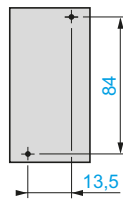

On pre-slotted plate AM1 PA

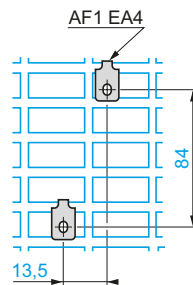

Adapter plate GK2AF01

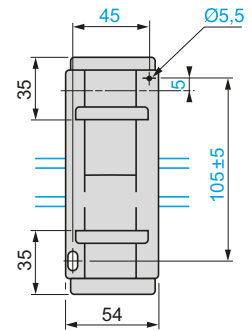
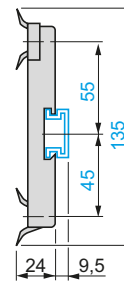

Circuit breakers

### Dimensions

#### GV2AF01

Combination GV2ME + TeSys k contactor

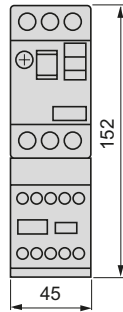
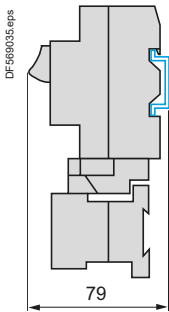

#### GV2AF3

Combination GV2ME + TeSys d contactor

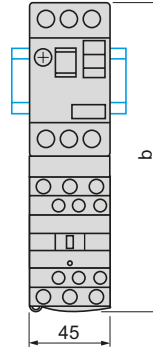
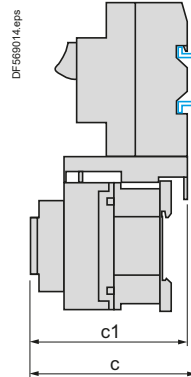

Combination GV2P + TeSys d contactor

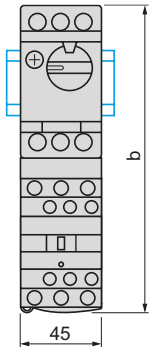
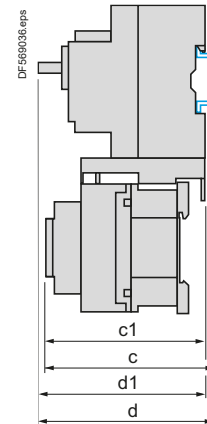

GV2ME +	LC1D09 ...D18	LC1D25 and D32
b	176.4	186.8
c1	94.1	100.4
c	99.6	105.9

GV2P +	LC1D09 ...D18	LC1D25 and D32
b	176.4	186.8
c1	100.1	106.4
c	105.6	111.9
d1	95	95
d	100.5	100.5

# Dimensions, mounting - TeSys GV2 - 0.06 to 15 kW

## TeSys protection components

Thermal-magnetic motor circuit breakers GV2ME and GV2P

### Dimensions

#### GV2AF4 + LAD311

Combination GV2ME + TeSys d contactor

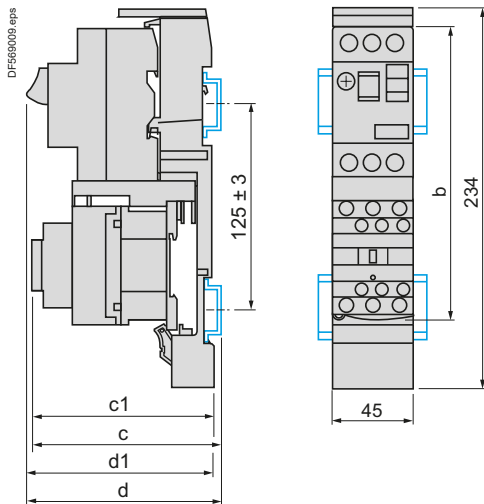

GV2ME +	LC1D09...D18	LC1D25 and D32
<b>b</b>	176.4	186.8
<b>c1</b>	103.1	136.4
<b>c</b>	135.6	141.9
<b>d1</b>	107	107
<b>d</b>	112.5	112.5

#### GV2ME + GV1L3 (current limiter)

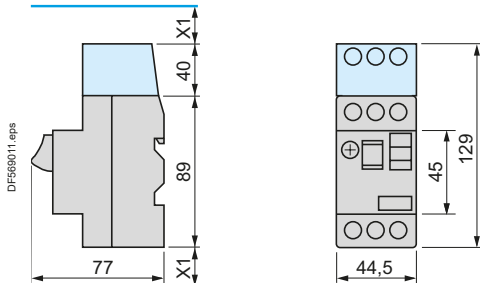

X1 = 10 mm for Ue = 230 V  
or 30 mm for 230 V < Ue ≤ 690 V

#### 7.5 mm height compensation plate GV1F03



Circuit breakers

# Dimensions, mounting - TeSys GV2 - 0.06 to 15 kW

## TeSys protection components

### Thermal-magnetic motor circuit breakers GV2P

#### Mounting

##### Mounting of external operator GV2APN01, GV2APN02 or GV2APN04 for motor circuit breakers GV2P

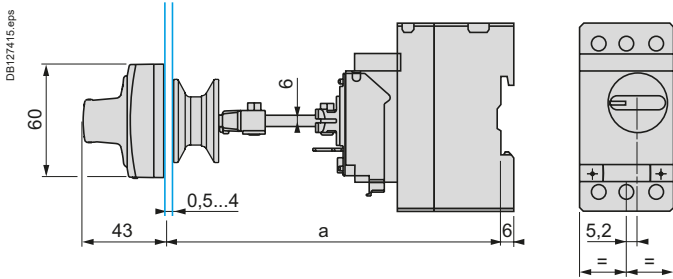

##### Door cut-out

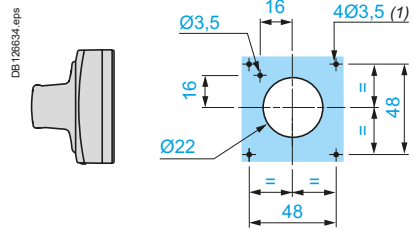

(1) For IP65 only.

##### Mounting of external operator GVAPH02 for motor circuit breakers GV2P

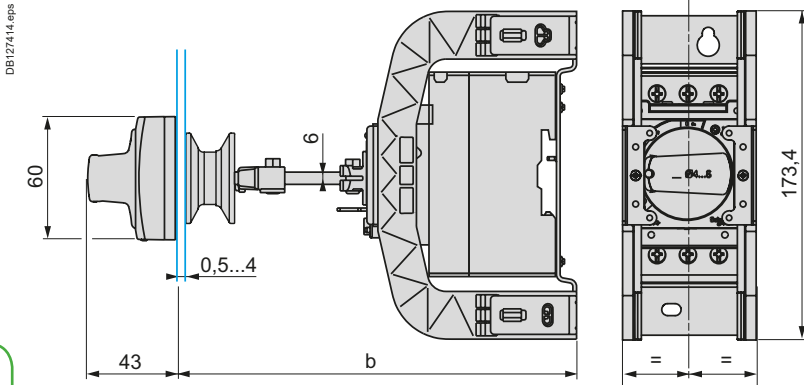

##### Door cut-out

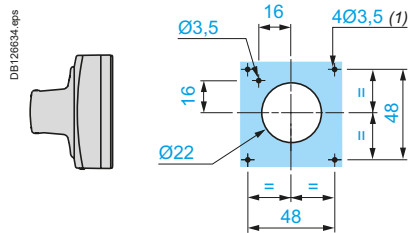

(1) For IP65 only.

Circuit breakers

	a		b	
	Mini	Maxi	Mini	Maxi
GV2APN●●	140	250		
GV2APN●● + GVAPH02			151	250
GV2APN●● + GVAPK11	250	434	-	-
GV2APN●● + GVAPH02 + GVAPK11	-	-	250	445



## TeSys protection components

Thermal-magnetic motor circuit breakers GV2ME and GV2P

### GV2ME, GV2P

Sets of busbars GV2G445, GV2G454, GV2G472, with terminal block GV2G05

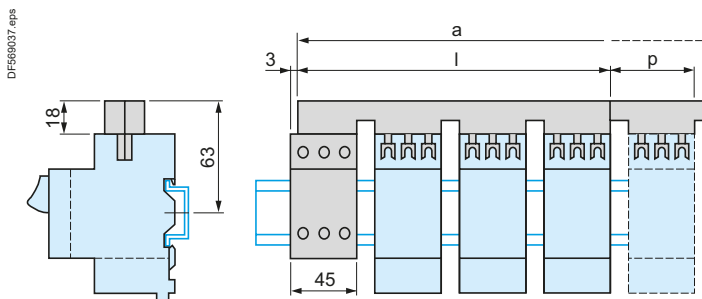

	l	p
GV2G445 (4 x 45 mm)	179	45
GV2G454 (4 x 54 mm)	206	54
GV2G472 (4 x 72 mm)	260	72

Number of tap-offs	a			
	5	6	7	8
GV2G445	224	269	314	359
GV2G454	260	314	368	422
GV2G472	332	404	476	548

### Sets of busbars GV2G●●● with terminal block GV1G09

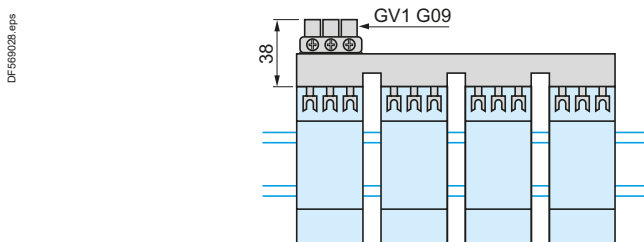

	l
GV2G245 (2 x 45 mm)	89
GV2G254 (2 x 54 mm)	98
GV2G272 (2 x 72 mm)	116

### Sets of busbars GV2G245, GV2G254, GV2G272

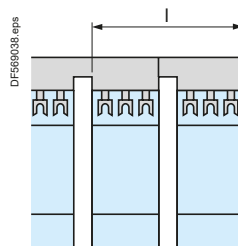

### Sets of busbars GV2G554

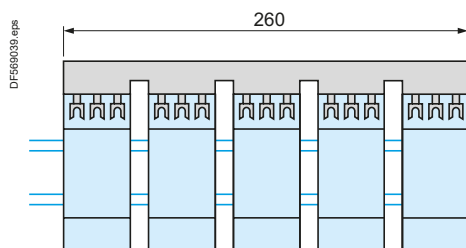

	l
GV2G345 (3 x 45 mm)	134
GV2G354 (3 x 54 mm)	152

### Sets of busbars GV2G345 and GV2G354

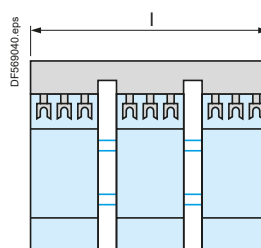

Circuit breakers

# Dimensions, mounting - TeSys GV2 - 0.06 to 15 kW

## TeSys protection components

### Thermal-magnetic motor circuit breakers GV2RT

#### GV2RT

##### Dimensions

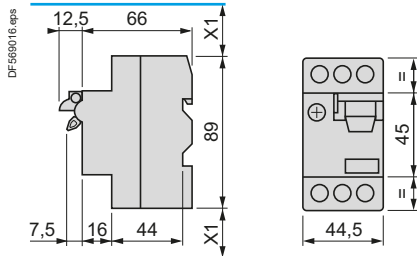

X1: Electrical clearance = 40 mm for  $U_e < 690\text{ V}$

##### Mounting

##### Mounting of external operator GV2AP03

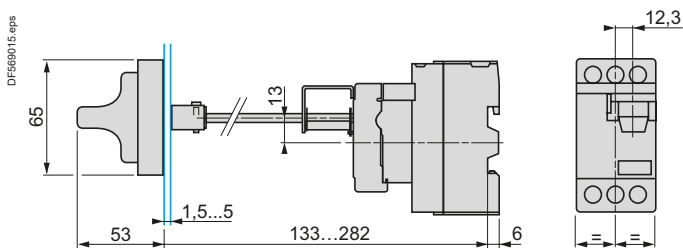

Circuit breakers

##### On 35 mm rail

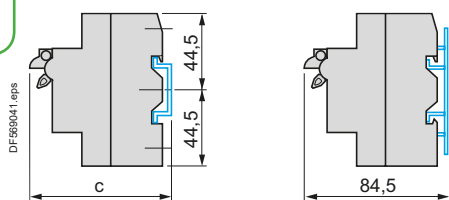

$c = 80$  on AM1 DP200 (35 x 7.5)  
 $c = 88$  on AM1 DE200, ED200 (35 x 15)

##### On panel with adapter plate GV2AF02

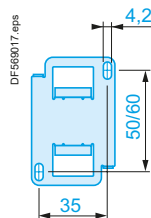

##### On pre-slotted plate AM1 PA

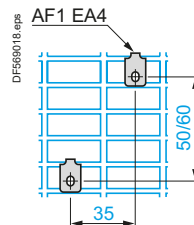

##### On rails DZ5 MB

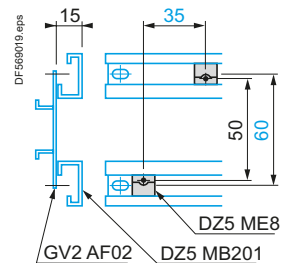

TeSys protection components

Thermal-magnetic motor circuit breakers GV2L, GV2LE, GV2ME, GV2P, GV2RT

Schemes

GV2L●●

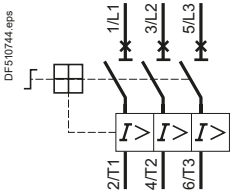

GV2LE●●

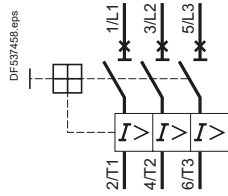

GV2P●●

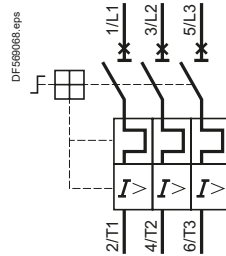

GV2ME●● and GV2RT

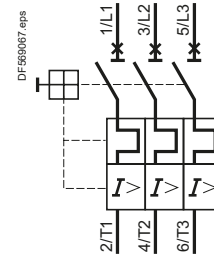

Front mounting add-on contact blocks  
Instantaneous auxiliary contacts

GVAE1

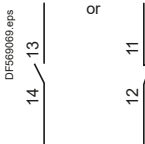

GVAE11

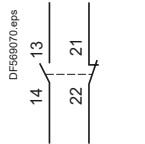

GVAE20

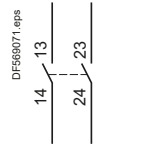

Front mounting add-on contact blocks  
Instantaneous auxiliary contacts and fault signalling contacts

GVAED101

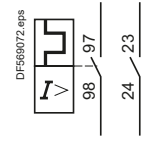

GVAED011

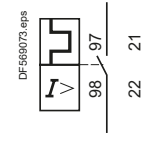

Side mounting add-on contact blocks  
Instantaneous auxiliary contacts and fault signalling contacts

GVAD0110

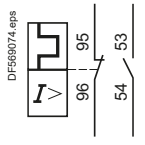

GVAD0101

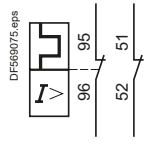

GVAD1010

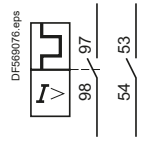

GVAD1001

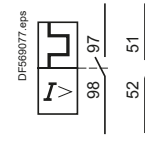

Instantaneous auxiliary contacts

GVAN11

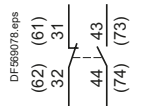

GVAN20

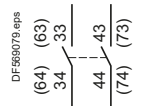

Short-circuit signalling contacts

GVAM11

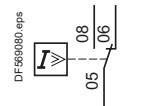

Start-Stop signalling contact blocks

GK2AX10

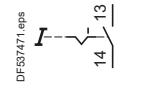

GK2AX20

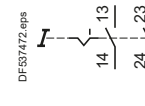

GK2AX50

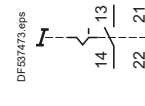

Fault signaling contact blocks

GK2AX12

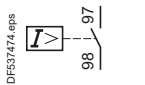

GK2AX22

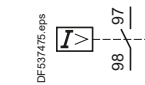

GK2AX52

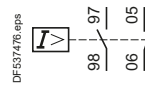

Voltage trips

GVAU●●●

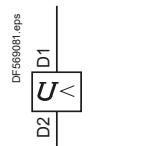

GVAS●●●

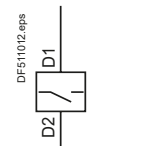

GVAX●●●

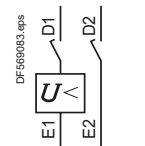

Current limiter

GV1L3

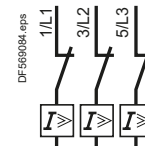

Use of fault signalling contact and short-circuit signalling contact

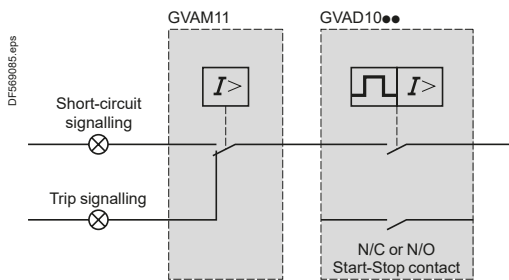

Connection of undervoltage trip for dangerous machines (conforming to INRS) on GV2ME only

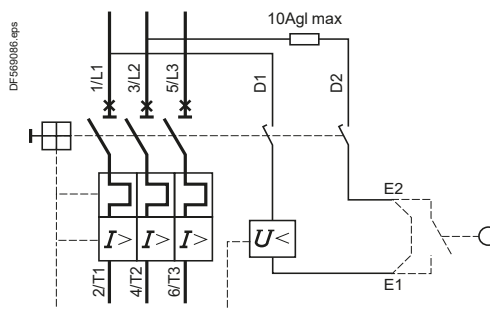



# TeSys GV3

5 to 45 kW



## TeSys protection components

### Motor circuit breakers

Environment				
Circuit breaker type			GV3L	GV3P
Conforming to standards			IEC/EN 60947-4-1 IEC/EN 60947-2	IEC/EN 60947-4-1 IEC/EN 60947-2 UL 60947-4-1 CSA C22.2 n° 60947-4-1
Product certifications			CCC, EAC, BV, LROS, DNV-GL, ABS	CCC, UL, CSA, EAC, ATEX, BV, LROS, DNV-GL, ABS
Climatic withstand			According to IACS E10	
Degree of protection (front face)	Conforming to IEC 60529	Open mounted	Against direct finger contact: IP20	
		In enclosure	-	<b>GV3 PC01</b> and <b>GV3 PC02</b> : IP55
Shock resistance	Conforming to IEC 60068-2-27		On: 15 gn -11 ms (On: 5 gn -11 ms for GV3L73, GV3L80, GV3P73, GV3P80) Off: 30 gn -11 ms	
Vibration resistance <sup>(1)</sup>	Conforming to IEC 60068-2-6		4 gn (5...300 Hz)	
Ambient air temperature	Storage		°C	-40...+80
	Operation	Open mounted	°C	-20...+60 <sup>(2)</sup>
Temperature compensation		In enclosure	Open mounted	°C
	In enclosure		°C	-20...+60
Flame resistance	Conforming to IEC 60695-2-11		°C	960
Maximum operating altitude			m	3000
Suitable for isolation	Conforming to IEC 60947-1 § 7-1-6			Yes
Resistance to mechanical impact			J	-
				10 IK09 (in enclosure)
Sensitivity to phase failure			Yes, conforming to IEC 60947-4-1 § 8-2-1-5-2 for GV3P	

Technical characteristics				
Circuit breaker type			GV3L	GV3P
Utilisation category	Conforming to IEC 60947-2		A	-
	Conforming to IEC 60947-4-1		-	AC-3
Rated operational voltage (U <sub>e</sub> )	Conforming to IEC 60947-2	V	690	
Rated insulation voltage (U <sub>i</sub> )	Conforming to IEC 60947-2	V	690	
Rated voltage	Conforming to UL 60947-4-1, CSA C 22.2 n° 60947-4-1	V		600
Rated operational frequency	Conforming to IEC 60947-4-1 UL, CSA	Hz	50/60	
Rated impulse withstand voltage (U <sub>imp</sub> )	Conforming to IEC 60947-2	kV	6	
Total power dissipated per pole		W	8	
Mechanical durability (C.O.: Close, Open)		C.O.	50 000	
Electrical durability for AC-3 duty	415 V I <sub>n</sub>	C.O.	50 000 (20 000 for GV3L73, GV3P73, GV3L80, GV3P80)	
Duty class (maximum operating rate)		C.O./h	25	
Maximum conventional rated thermal current (I <sub>th</sub> )	Conforming to IEC 60947-4-1	A	-	13 to 80
Rated duty	Conforming to IEC 60947-4-1			Continuous duty
Operating threshold of magnetic trips				14 I max

<sup>(1)</sup> In case of vibration above 3 gn on contactor with electronic coil (TeSys D Green) and direct mounting with LRD relay, it is recommended to mount the devices separately by screws on metal plate.

<sup>(2)</sup> Leave a space of 9 mm between 2 circuit breakers: either an empty space, or side mounting add-on contact blocks. Side by side mounting is possible up to 40 °C.

# Characteristics - TeSys GV3 - 5.5 to 45 kW

## TeSys protection components

### Motor circuit breakers

#### Mounting characteristics

Operating position

Without derating, in relation to normal vertical mounting plane <sup>(1)</sup>

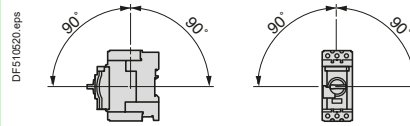

#### Connection characteristics

##### Connection to screw clamp terminals or spring terminals

Bare cables

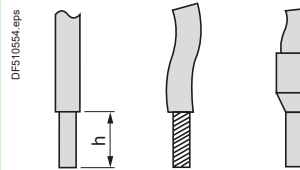

Circuit breaker type			GV3 L		GV3 P	
Connection to screw clamp terminals <sup>(2)</sup> (Max. number of conductors x c.s.a.)			Min.	Max.	Min.	Max.
	Solid cable	mm <sup>2</sup>	2 x 1	1 x 25 and 1 x 35	2 x 1	1 x 25 and 1 x 35
	Flexible cable without cable end	mm <sup>2</sup>	2 x 1	1 x 25 and 1 x 35	2 x 1	1 x 25 and 1 x 35
	Flexible cable with cable end	mm <sup>2</sup>	2 x 1	1 x 25 and 1 x 35	2 x 1	1 x 25 and 1 x 35
	Tightening torque	N.m	5	5: 25 mm <sup>2</sup> 8: 35 mm <sup>2</sup>	5	5: 25 mm <sup>2</sup> 8: 35 mm <sup>2</sup>

##### Connection by bars or lugs

Bars or lugs

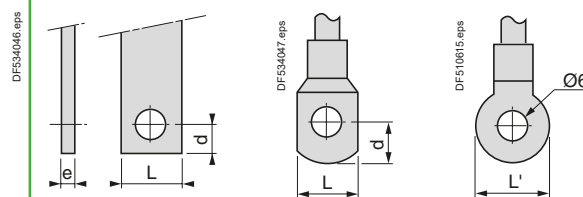

Circuit breaker type			GV3 L $\bullet\bullet$ 6	GV3 P $\bullet\bullet$ 6
Pitch	Without spreaders	mm	17.5	
	With spreaders	mm	–	
Bars or cables with lugs	e	mm	≤ 6	
	L	mm	≤ 13.5	
	L'	mm	≤ 16.5	
	d	mm	≤ 10	
Screws			M6	
	Tightening torque	N.m	6	
Bare cables (copper or aluminium) with connectors	Height (h)	mm	–	
	C.s.a.	mm <sup>2</sup>	–	
	Tightening torque	N.m	–	

<sup>(1)</sup> When mounting on a vertical rail, fit a stop to prevent any slippage.

<sup>(2)</sup> For motor circuit breakers **GV3P**: BTR hexagon socket head screws, **EverLink**® system.

Require use of an insulated Allen key, in compliance with local electrical wiring regulations.

<sup>(3)</sup> For cross-sections 1 to 1.5 mm<sup>2</sup>, the use of an **LA9D99** cable end reducer is recommended.

## TeSys protection components

### Motor circuit breakers GV3L

#### Breaking capacity of GV3L

Type			GV3L25	GV3L32	GV3L40	GV3L50	GV3L65	GV3L73	GV3L80	
Breaking capacity of the circuit-breaker only or of the circuit-breaker combined with a thermal overload relay	230/240 V	Icu	kA	100	100	100	100	100	65	65
		Ics % <sup>(1)</sup>		100	100	100	100	100	100	100
	400/415 V	Icu	kA	100	100	50	50	50	50	50
		Ics % <sup>(1)</sup>		100	100	100	100	100	60	60
	440 V	Icu	kA	50	50	50	50	50	50	50
		Ics % <sup>(1)</sup>		100	100	100	100	100	60	60
	500 V	Icu	kA	12	12	12	12	12	12	12
		Ics % <sup>(1)</sup>		50	50	50	50	50	50	50
	690 V	Icu	kA	6	6	6	6	6	6	6
		Ics % <sup>(1)</sup>		50	50	50	50	50	50	50
	Associated fuses (if required) for use with circuit breaker only or circuit breaker combined with a thermal overload relay if Isc > breaking capacity	230/240 V	aM	A	*	*	*	*	*	*
			gG	A	*	*	*	*	*	*
415 V		aM	A	*	*	*	*	125	125	125
		gG	A	*	*	*	*	160	160	160
440 V		aM	A	63	80	125	125	125	125	125
		gG	A	80	100	160	160	160	160	160
500 V		aM	A	63	63	63	63	80	80	80
		gG	A	80	80	80	80	100	100	100
690 V		aM	A	50	50	50	50	63	63	63
		gG	A	63	63	63	63	80	80	80
Use of circuit breakers without fuses			Minimum cable length (in metres) limiting the maximum short-circuit current to 35 kA maximum.							
Cable c.s.a.			mm <sup>2</sup>	≤ 25	35	50	70	95	- <sup>(2)</sup>	- <sup>(2)</sup>
Isc (rms) 3-phase, incoming (Ue = 415 V)	50 kA	m	5	6	8	10	13	- <sup>(2)</sup>	- <sup>(2)</sup>	
	45 kA	m	5	5	7	8	10	- <sup>(2)</sup>	- <sup>(2)</sup>	
	40 kA	m	5	5	5	5	8	- <sup>(2)</sup>	- <sup>(2)</sup>	
	37 kA	m	5	5	5	5	5	- <sup>(2)</sup>	- <sup>(2)</sup>	

\* Fuse not required: breaking capacity Icn > Isc.

<sup>(1)</sup> As % of Icu.

<sup>(2)</sup> Please consult your Regional Sales Office.



TeSys protection components

Motor circuit breakers GV3P

Breaking capacity of GV3P													
Motor circuit breaker type			GV3P										
		A	13	18	25	32	40	50	65	73	80		
Rating		A	13	18	25	32	40	50	65	73	80		
Breaking capacity conforming to IEC 60947-2	230/240 V	Icu	kA	100	100	100	100	100	100	100	100	100	
		Ics % <sup>(1)</sup>		100	100	100	100	100	100	100	100	100	
	400/415 V	Icu	kA	100	100	100	100	50	50	50	50	50	
		Ics % <sup>(1)</sup>		100	100	100	100	100	100	100	60	60	
	440 V	Icu	kA	50	50	50	50	50	50	50	50	50	
		Ics % <sup>(1)</sup>		100	100	100	100	100	100	100	60	60	
	500 V	Icu	kA	12	12	12	12	12	12	12	12	12	
		Ics % <sup>(1)</sup>		50	50	50	50	50	50	50	50	50	
	690 V	Icu	kA	6	6	6	6	6	6	6	6	6	
		Ics % <sup>(1)</sup>		50	50	50	50	50	50	50	50	50	
	Associated fuses, if required if Isc > breaking capacity Icu	230/240 V	aM	A	*	*	*	*	*	*	*	*	*
			gG	A	*	*	*	*	*	*	*	*	*
415 V		aM	A	*	*	*	*	125	125	125	125	125	
		gG	A	*	*	*	*	160	160	160	160	160	
440 V		aM	A	63	80	125	125	125	125	125	125	125	
		gG	A	80	100	160	160	160	160	160	160	160	
500 V		aM	A	63	63	63	63	80	80	80	80	80	
		gG	A	80	80	80	80	100	100	100	100	100	
690 V		aM	A	50	50	50	50	63	63	63	63	63	
		gG	A	63	63	63	63	80	80	80	80	80	

\* Fuse not required: breaking capacity Icn > Isc.  
 (1) As % of Icu.

Circuit breakers

# Curves - TeSys GV3 - 5.5 to 45 kW

## TeSys protection components

### Magnetic motor circuit breakers GV3L

#### Tripping curves for GV3L combined with thermal overload relay LRD33

Average operating time at 20 °C without prior current flow

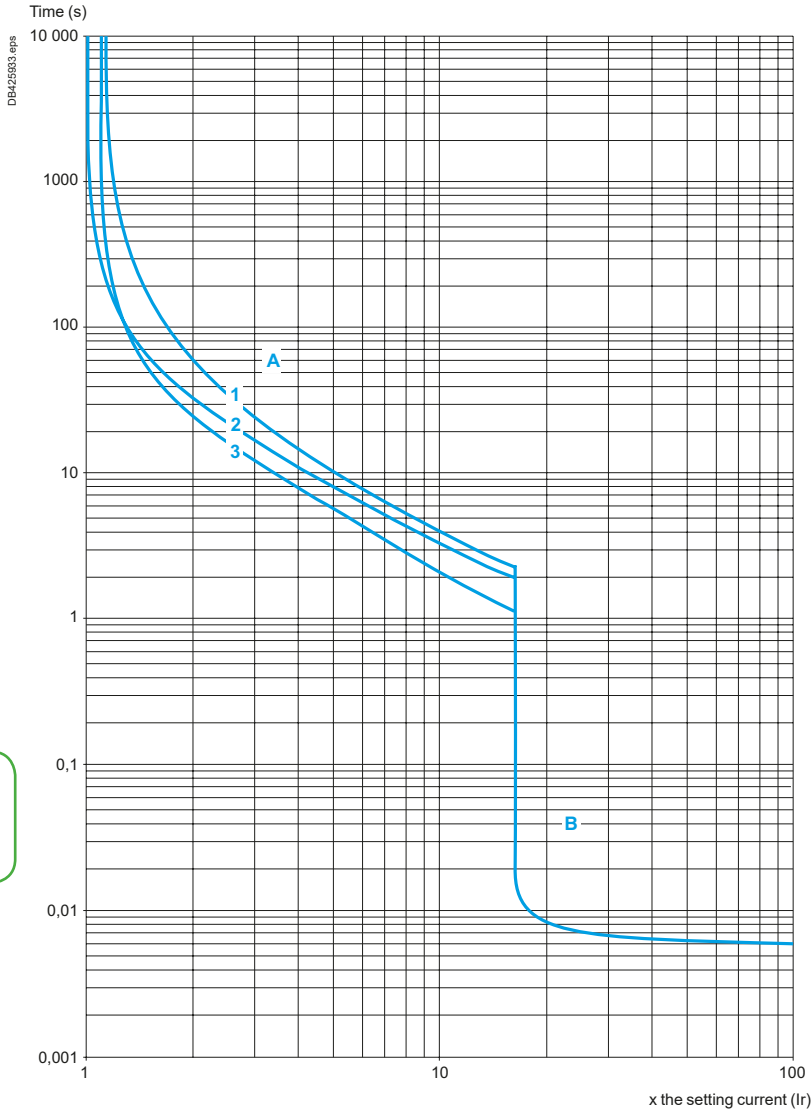

- 1 3 poles from cold state
- 2 2 poles from cold state
- 3 3 poles from hot state

- A Thermal overload relay protection zone
- B GV3L protection zone

# Curves - TeSys GV3 - 5.5 to 45 kW

## TeSys protection components

### Magnetic motor circuit breakers GV3L

#### Current limitation on short-circuit for GV3L (3-phase 400/415 V)

##### Dynamic stress

$I_{peak} = f(\text{prospective } I_{sc}) \text{ at } 1.05 U_e = 435 \text{ V}$

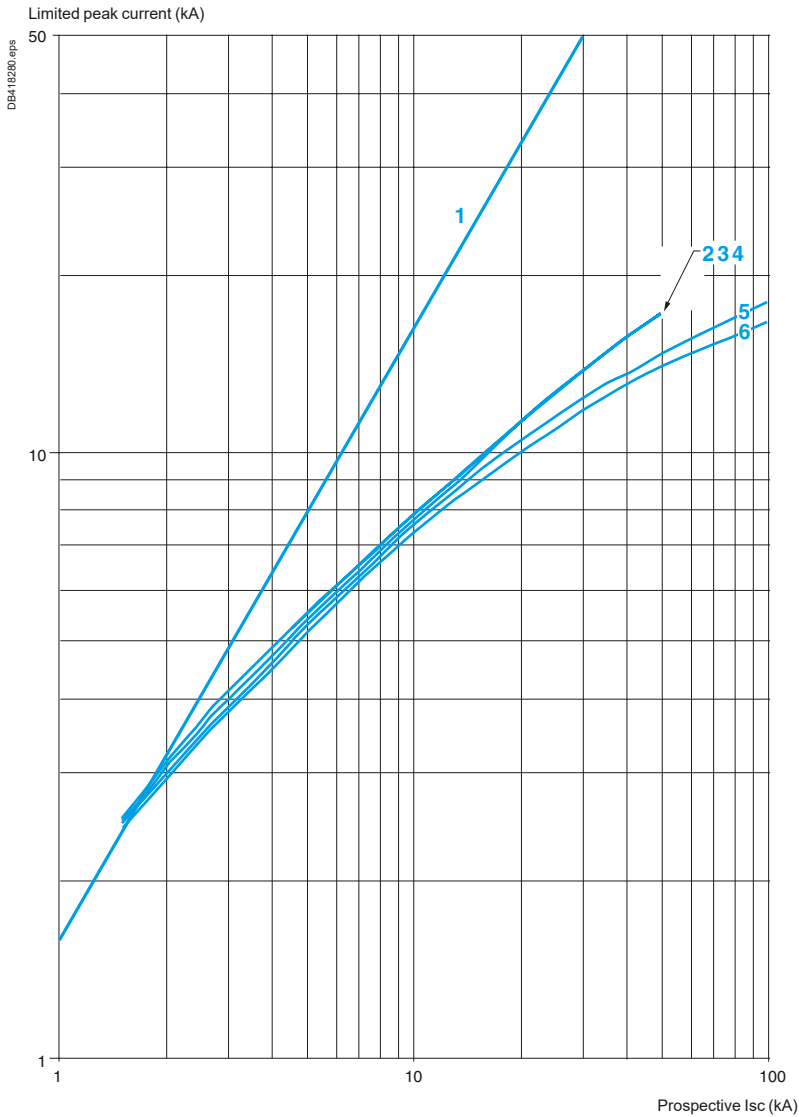

- 1 Maximum peak current
- 2 GV3L80 - GV3L73 - GV3L65
- 3 GV3L50
- 4 GV3L40
- 5 GV3L32
- 6 GV3L25

## Curves - TeSys GV3 - 5.5 to 45 kW

### TeSys protection components

#### Magnetic motor circuit breakers GV3L

#### Thermal limit on short-circuit for GV3L

##### Thermal limit in A<sup>2</sup>s

Sum of  $I^2dt = f$  (prospective  $I_{sc}$ ) at  $1.05 U_e = 435 V$

Sum of  $I^2dt$  (A<sup>2</sup>s)

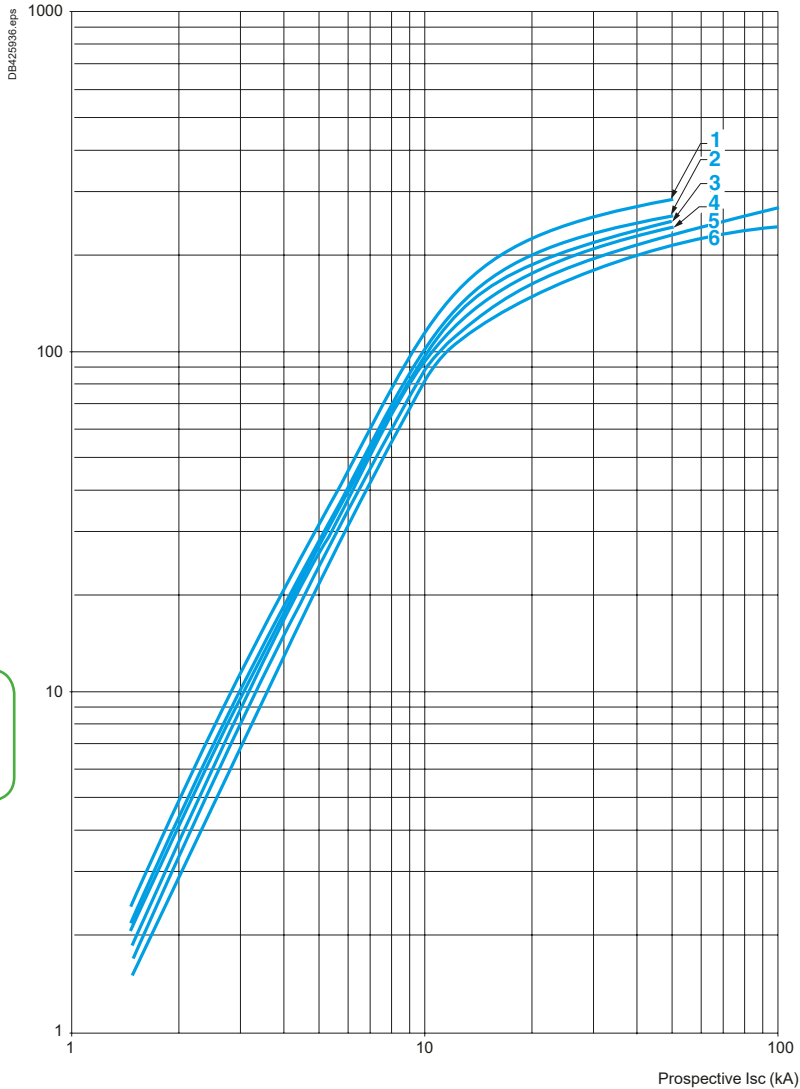

- 1 GV3L73 - GV3L80
- 2 GV3L65
- 3 GV3L50
- 4 GV3L40
- 5 GV3L32
- 6 GV3L25

**Thermal-magnetic tripping curves**

Average operating times at 20 °C related to multiples of the setting current

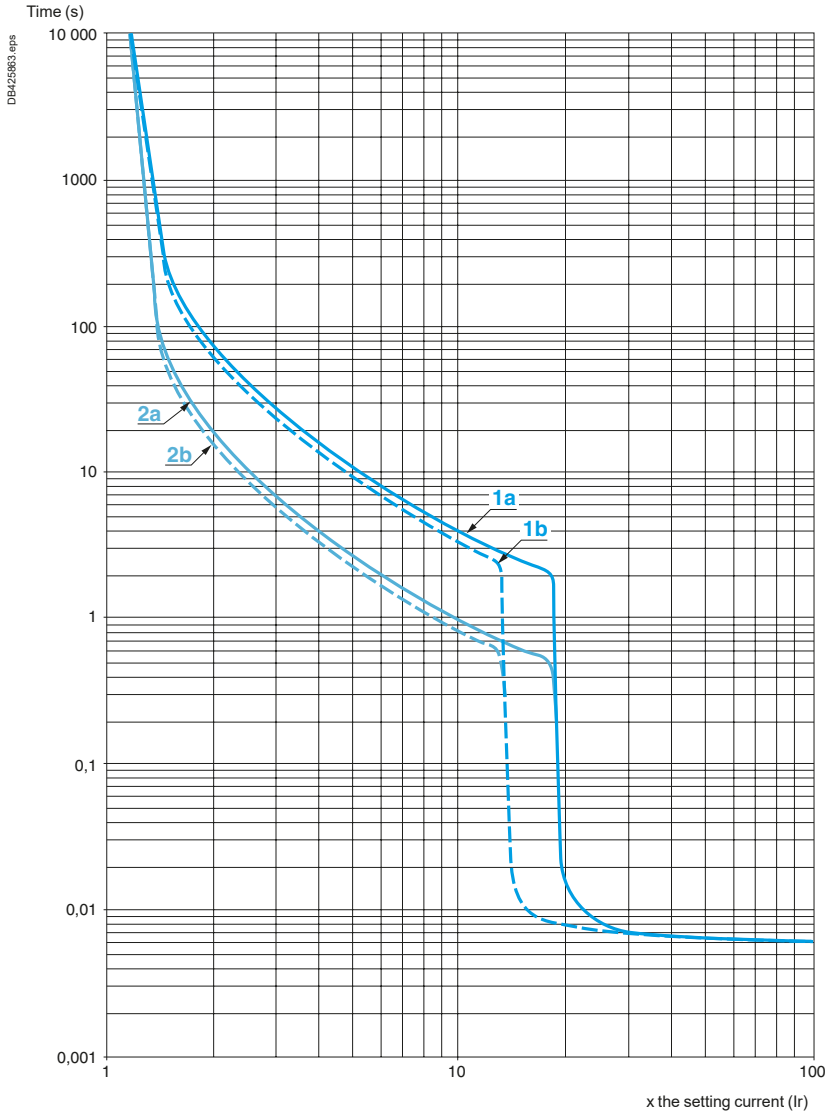

- 1a 3 poles from cold state (Ir mini.): GV3P
- 1b 3 poles from cold state (Ir maxi.): GV3P
- 2a 3 poles from hot state (Ir mini.): GV3P
- 2b 3 poles from hot state (Ir maxi.): GV3P

Circuit breakers

# TeSys protection components

Thermal-magnetic motor circuit breakers GV3P

## Current limitation on short-circuit (3-phase 400/415 V)

### Dynamic stress

$I_{peak} = f(\text{prospective } I_{sc}) \text{ at } 1.05 U_e = 435 \text{ V}$

Limited peak current (kA)

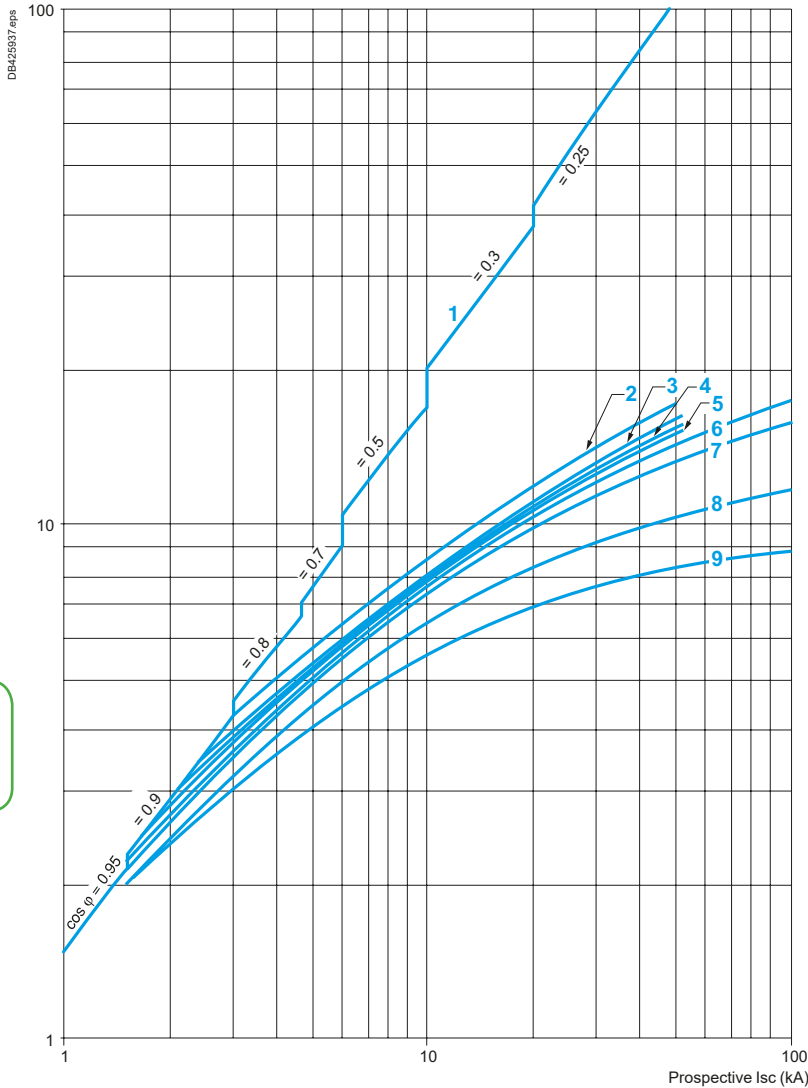

- 1 Maximum peak current
- 2 70-80 A (GV3P80); 62-73 A (GV3P73)
- 3 48-65 A (GV3P65)
- 4 37-50 A (GV3P50)
- 5 30-40 A (GV3P40)
- 6 23-32 A (GV3P32)
- 7 17-25 A (GV3P25)
- 8 12-18 A (GV3P18)
- 9 9-13 A (GV3P13)

# TeSys protection components

## Thermal-magnetic motor circuit breakers GV3P

### Maximum thermal limit on short-circuit

#### Thermal limit in kA<sup>2</sup>s in the magnetic operating zone

Sum of  $I^2dt = f$  (prospective  $I_{sc}$ ) at  $1.05 U_e = 435 V$

Sum of  $I^2dt$  (kA<sup>2</sup>s)

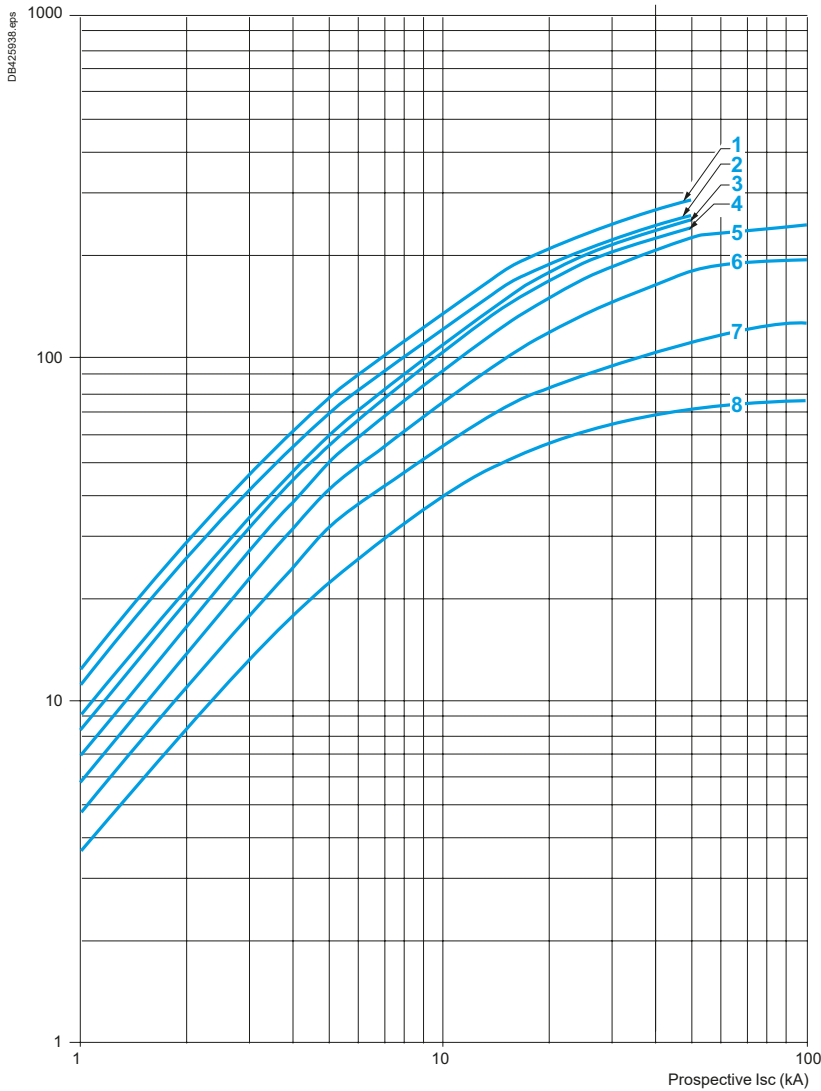

- 1 70-80 (GV3P80) - 62-73 (GV3P73)
- 2 48-65 A (GV3P65)
- 3 37-50 A (GV3P50)
- 4 30-40 A (GV3P40)
- 5 23-32 A (GV3P32)
- 6 17-25 A (GV3P25)
- 7 12-18 A (GV3P18)
- 8 9-13 A (GV3P13)

## TeSys protection components

### GV3 motor circuit breakers

#### Electric trips

Characteristics of GV3 electric trips				
Type of trip			GVAU●●● MN undervoltage trip	GVAS●●● MX shunt trip
Rated insulation voltage (Ui)	Conforming to IEC 60947-1	V	690	690
	Conforming to CSA C22-2 n°14, UL 508	V	600	600
Operational voltage (Ue)	Conforming to IEC 60947-1	V	0.85...1.1 U <sub>c</sub>	0.7...1.1 U <sub>c</sub>
Drop-out voltage		V	0.7...0.35 U <sub>c</sub>	0.75...0.2 U <sub>c</sub>
Inrush consumption	~ ≡	VA	12	14
Sealed consumption	~ ≡	VA	3.5	5
Operating time	Conforming to IEC 60947-1	ms	From the moment the voltage reaches its operational value until opening of the circuit breaker. 10...15	
On-load factor			100 %	
Cabling (spring connection)	Number of conductors		2 or 4	
	Solid cable	mm <sup>2</sup>	1...2.5	
	Flexible cable without cable end	mm <sup>2</sup> AWG	0.75...2.5	
	Flexible cable with cable end	mm <sup>2</sup>	0.75...2.5	
Tightening torque		N.m	1.4 max	
Mechanical durability (C.O.: Close - Open)		C.O.	10000 (GV3 P and GV3 L)	



# Accessories - TeSys GV3 - 5.5 to 45 kW

## TeSys protection components

### Motor circuit breakers GV3P, GV3L

#### Auxiliary contacts

Type of contacts			Instantaneous auxiliary GVAN, GVAD							Fault signalling GVAD, GVAM11 <sup>(1)</sup>				Instantaneous auxiliary GVAE				
Rated insulation voltage (Ui) (associated insulation coordination)	Conforming to IEC 60947-1	<b>V</b>	690							690				250 (690 in relation to main circuit)				
	Conforming to UL 60947-4-1, CSA C22.2 n° 60947-4-1	<b>V</b>	600							300				300				
Conventional thermal current (Ith)	Conforming to IEC 60947-5-1	<b>A</b>	6							2.5				2.5				
	Conforming to UL 60947-5-1, CSA C22.2 n° 60947-5-1	<b>A</b>	5							1				1				
Mechanical durability (C.O.: Close - Open)		<b>C.O.</b>	100 000							1000				100 000				
Operational power and current conforming to IEC 60947-5-1. a.c. operation			AC-15/100 000 C.O.							AC-14/1000 C.O.				AC-15/100 000 C.O.				
	<b>Rated operational voltage (Ue)</b>	<b>V</b>	<b>48</b>	<b>110</b>	<b>230</b>	<b>380</b>	<b>415</b>	<b>440</b>	<b>500</b>	<b>690</b>	<b>24</b>	<b>48</b>	<b>110</b>	<b>230</b>	<b>24</b>	<b>48</b>	<b>110</b>	<b>230</b>
Operation	Operational power, normal conditions	<b>VA</b>	300	500	720	850	650	500	400	36	48	72	72	48	60	120	120	
	Occasional breaking and making capacities, abnormal conditions	<b>kVA</b>	3	7	13	15	13	12	9	0.22	0.3	0.45	0.45	0.48	0.6	1.27	2.4	
	Rated operational current (Ie)	<b>A</b>	6	4.5	3.3	2.2	1.5	1	0.6	1.5	1	0.5	0.3	2	1.25	1	0.5	
Operational power and current conforming to IEC 60947-5-1. d.c. operation			DC-13/100 000 C.O.							DC-13/1000 C.O.				DC-13/100 000 C.O.				
	<b>Rated operational voltage (Ue)</b>	<b>V</b>	<b>24</b>	<b>48</b>	<b>60</b>	<b>110</b>	<b>240</b>	–	–	<b>24</b>	<b>48</b>	<b>60</b>	–	<b>24</b>	<b>48</b>	<b>60</b>	–	
Operation	Operational power, normal conditions	<b>W</b>	140	240	180	140	120	–	–	24	15	9	–	24	15	9	–	
	Occasional breaking and making capacities, abnormal conditions	<b>W</b>	240	360	240	210	180	–	–	100	50	50	–	100	50	50	–	
	Rated operational current (Ie)	<b>A</b>	6	5	3	1.3	0.5	–	–	1	0.3	0.15	–	1	0.3	0.15	–	
Low power switching reliability of contact			<b>GVAE:</b> Number of failures for "n" million operating cycles (17 V-5 mA): = 10 <sup>-6</sup>															
Minimum operational conditions d.c. operation		<b>V</b>	17															
		<b>mA</b>	5															
Short-circuit protection			By <b>GB2CB●●</b> circuit breaker (rating according to operational current for Ue ≤ 415 V) or by gG fuse 10 A max											<b>GB2CB06</b> or gG fuse 10 A max				
Cabling, screw clamp terminals	Number of conductors		<b>1</b>				<b>2</b>											
	Solid cable	<b>mm<sup>2</sup></b>	1...2.5				1...2.5											
	Flexible cable without cable end	<b>mm<sup>2</sup></b>	0.75...2.5				0.75...2.5											
	Flexible cable with cable end	<b>mm<sup>2</sup></b>	0.75...1.5				0.75...1.5											
	Tightening torque	<b>N.m</b>	1.4 max				1.4 max											
Cabling, spring terminal connections	Flexible cable without cable end	<b>mm<sup>2</sup></b>	<b>GVAN</b> only 0.75...2.5				0.75...2.5				–				0.75...1.5			

#### Operation of instantaneous auxiliary contacts

##### GV3P, GV3L

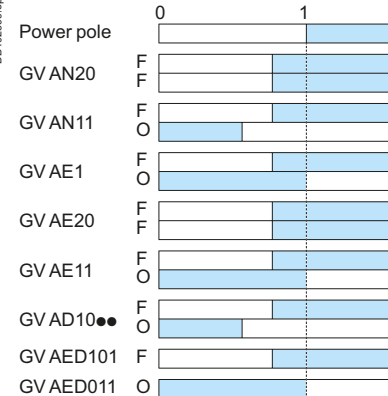

#### Operation of fault signalling contacts

##### GVAM11

Change of state following tripping on short-circuit.

##### GVAD10●● and GVAD01●●

Change of state following tripping on short-circuit, overload or undervoltage.

(1) For application example of fault signalling contact and short-circuit signalling contact.

(2) Add an RC circuit type **LA4 D** to the load terminals.

## Characteristics - TeSys GV3 - 5.5 to 45 kW

### TeSys protection components

#### Motor circuit breakers GV3

#### Accessories

Characteristics of 3-pole busbars GV3G●●●			
			GV3G●64
Rated insulation voltage (Ui)	Conforming to IEC 60947-1	V	690
Conventional thermal current (Ith)	Conforming to IEC 60439-1	A	115
Rated operational current (Ie)		A	115
Permissible peak current (I peak)		kA	20
Permissible thermal limit (I <sup>2</sup> t)		kA <sup>2</sup> s	300
Degree of protection	Conforming to IEC 60529		IP 20
Terminal block			—

# Dimensions, mounting - TeSys GV3 - 5.5 to 45 kW

## TeSys protection components

### Motor circuit breakers GV3L, GV3 P

#### GV3L, GV3P

##### Dimensions

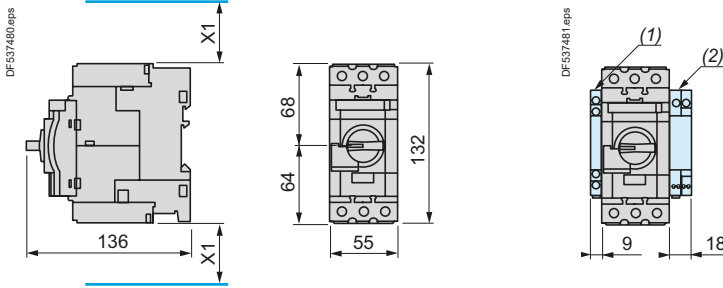

X1 = Electrical clearance (ISC max)  
40 mm for  $U_e \leq 500$  V, 50 mm for  $U_e \leq 690$  V

(1) Blocks **GVAN●●**, **GVAD●●** and **GVAM11**.  
(2) Blocks **GV3AU●●** and **GV3AS●●**.

**Note:** Leave a space of 9 mm between 2 circuit breakers: either an empty space or side-mounting add-on contact blocks.  
Side by side mounting is possible up to 40 °C.

##### Mounting

###### Mounting with Tesys contactor LC1D40A...D80A and relay LR3D313...380 (1) (2) (3)

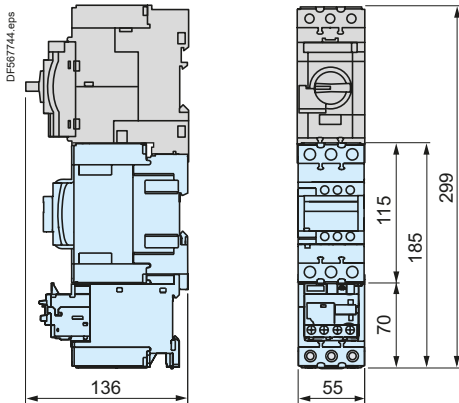

(1) Mountings with c.b. up to **GV3L73**, **GV3P73**.  
(2) For **GV3L80**, **GV3P80** use cable between components for dissipating heat. Consult online datasheets for values  
(3) S-shape busbar system suitable up to 73 A.

###### Side by side mounting with Tesys contactor LC1D40A...D73A (S-shape busbar system GV3S (4))

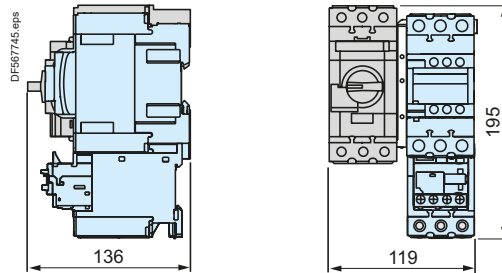

###### Mounting on rail AM1 DE200 or AM1 ED201

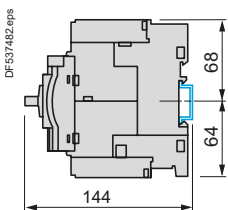

###### Panel mounting, using M4 screws

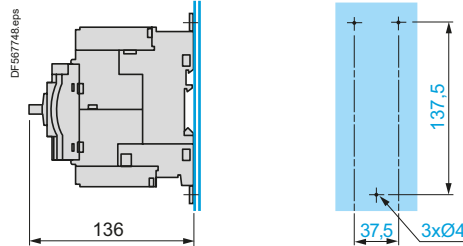

###### Mounting on pre-slotted plate AM1 PA

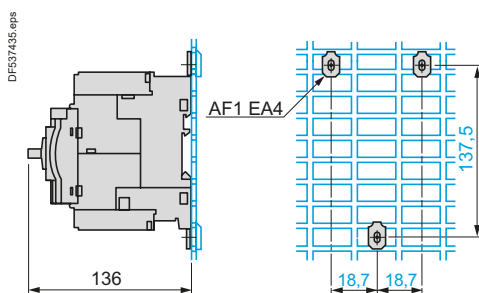

###### Set of busbars GV3G264

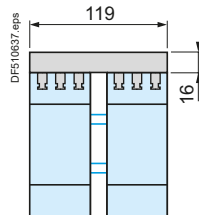

###### Set of busbars GV3G364

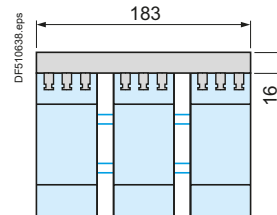

References:  
pages B6/25 to B6/30

Characteristics:  
pages B6/94 to B6/97

Curves:  
pages B6/98 to B6/103

Schemes:  
pages B6/109

# Dimensions, mounting - TeSys GV3 - 5.5 to 45 kW

## TeSys protection components

### Magnetic motor circuit breakers GV3L, GV3P

#### Mounting

##### Mounting of external operator GV3APN01, GV3APN02 or GV3APN04 for motor circuit breakers GV3L

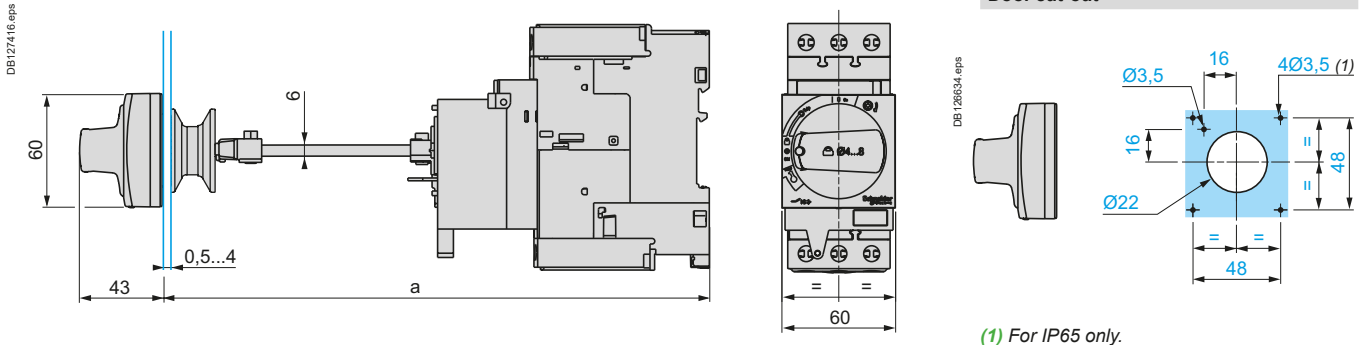

##### Mounting of external operator GVAPH03 for motor circuit breakers GV3L

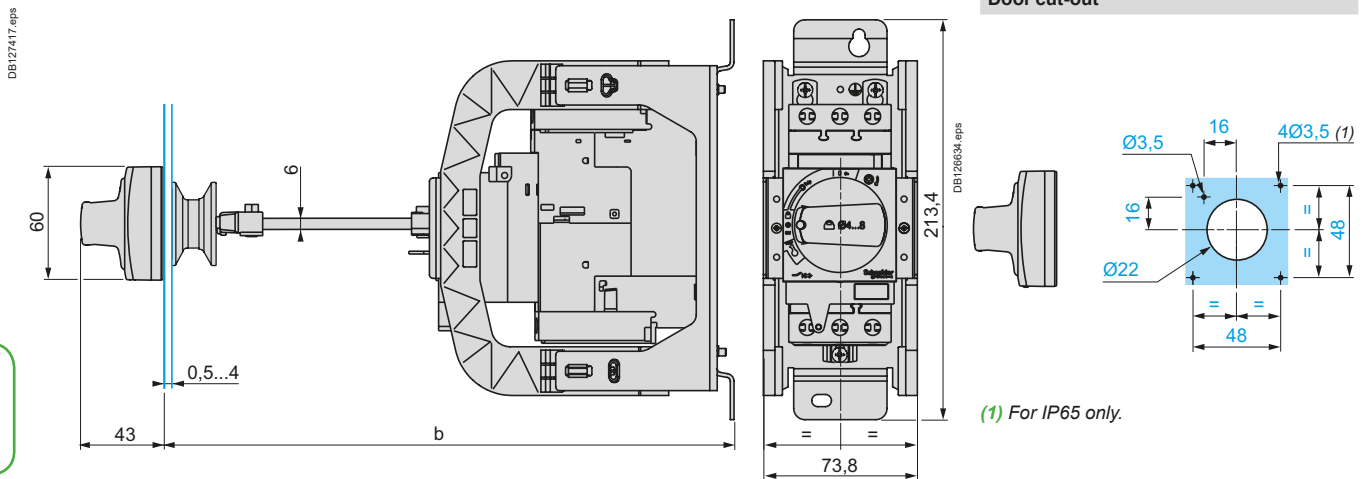

Circuit breakers

	a		b	
	Mini	Maxi	Mini	Maxi
GV3APN●●	189	300	-	-
GV3APN●● + GVAPK12	300	481	-	-
GV3APN●● + GVAPH03	-	-	200	300
GV3APN●● + GVAPH03 + GVAPK12	-	-	300	492

# Schemes - TeSys GV3 - 5.5 to 45 kW

## TeSys protection components

### Motor circuit breakers GV3L, GV3 P

#### Schemes

##### GV3L●●

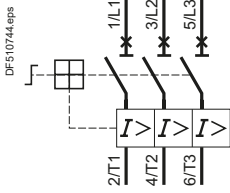

##### GV3P●●

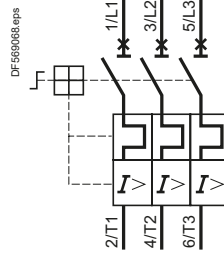

#### Front mounting add-on contact blocks Instantaneous auxiliary contacts

##### GVAE1

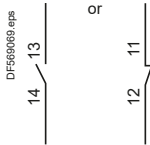

##### GVAE11

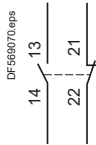

##### GVAE20

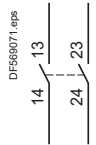

#### Front mounting add-on contact blocks Instantaneous auxiliary contacts and fault signalling contacts

##### GVAED101

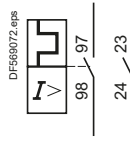

##### GVAED011

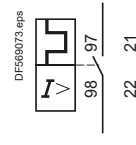

#### Side mounting add-on contact blocks Instantaneous auxiliary contacts and fault signalling contacts

##### GVAD0110

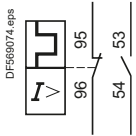

##### GVAD0101

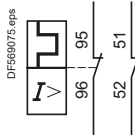

##### GVAD1010

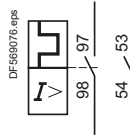

##### GVAD1001

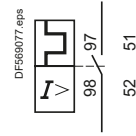

#### Instantaneous auxiliary contacts

##### GVAN11

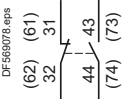

##### GVAN20

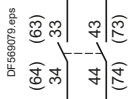

#### Short-circuit signalling contacts

##### GVAM11

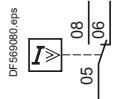

#### Voltage trips

##### GVAU●●●



##### GVAS●●●



##### GVAX●●●



#### Current limiter

##### GV1L3

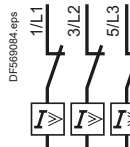

#### Use of fault signalling contact and short-circuit signalling contact

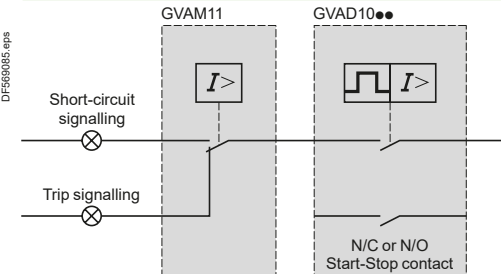

#### Start-Stop signalling contact blocks

##### GK2AX10

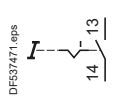

##### GK2AX20

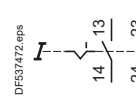

##### GK2AX50

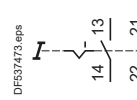

#### Fault signalling contact blocks

##### GK2AX12

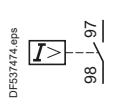

##### GK2AX22

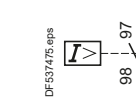

##### GK2AX52

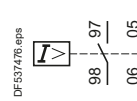

Circuit breakers



# TeSys GV4

0.25 to 55 kW - 1/2 to 60 HP



Circuit  
breakers

# Characteristics - TeSys GV4 - 0.25 to 55 kW

## TeSys protection components

### Motor circuit breakers TeSys GV4

Environment							
Circuit breaker type		GV4L	GV4LE	GV4P	GV4PE	GV4PEM	GV4PB
Conforming to standards		IEC/EN 60947-1, IEC/EN 60947-2, IEC/EN 60947-4-1		IEC/EN 60947-1, IEC/EN 60947-2, IEC/EN 60947-4-1, UL 60497-4-1, CSA 22.2 n° 60497-4-1		IEC/EN 60947-2, IEC/EN 60947-4-1	
Product certifications		CCC, EAC		CCC, EAC, CSA (cCSAus), ATEX		UL 489, CSA C22.2 n°5	
Climatic withstand		According to IACS E10					
Degree of protection (front face)	Conforming to IEC 60529	IP 40 front face except on connection area. Connection area: - IP20 with EverLink connector - IP40 with crimp lug connector and terminal shield.					
	Open mounted						
	In enclosure <sup>(1)</sup>	DRH = IP40 ERH = IP54 or IP65					
Shock resistance	Conforming to IEC 60068-2-27	15g - 11 ms		15g - 11 ms			
Vibration resistance	Conforming to IEC 60068-2-6	2.0 to 13.2 Hz and amplitude ±1 mm 13.2 to 100 Hz acceleration 0.7 g					
Ambient air temperature	Storage	°C	-50...+85				
	Operation	°C	-25...+70				
Temperature compensation		°C	Non applicable		-25...+60 <sup>(2)</sup>		
Flame resistance	Conforming to IEC 60695-2-11	°C	960				
Maximum operating altitude		m	2000 without derating. Up to 5000 with derating				
Suitable for isolation	Conforming to IEC 60947-1 § 7-1-6		Yes				
Resistance to mechanical impact		J	IK07 (2J)				
Sensitivity to phase failure			No		Yes		
Technical characteristics							
Utilisation category	Conforming to IEC 60947-2		A		A		
	Conforming to IEC 60947-4-1		AC-3 <sup>(3)</sup>				
Rated operational voltage (U <sub>e</sub> )	Conforming to IEC 60947-2	V	690				
Rated insulation voltage (U <sub>i</sub> )	Conforming to IEC 60947-2	V	800				
Rated voltage	Conforming to CSA C22-2 n°1, UL 60947-4-1	V	Non applicable		600		
Rated operational frequency	Conforming to IEC 60947-4-1, UL, CSA	Hz	50/60				
Rated impulse withstand voltage (U <sub>imp</sub> )	Conforming to IEC 60947-2	kV	8				
Total power dissipated per pole		W	6.1		4.6		
Mechanical durability (C.O.: Closing, Opening)		C.O.	40000				
Electrical durability for AC-3/415V duty (C.O.: Closing, Opening)	415 V In	C.O.	5 000				
Duty class (maximum operating rate)		C.O./h	25				
Maximum conventional rated thermal current (I <sub>th</sub> )	Conforming to IEC 60947-4-1	A	115				
Rated duty	Conforming to IEC 60947-4-1		Continuous duty				

(1) DRH = with Direct Rotary Handle

ERH = with Extended Rotary Handle

(2) For operation up to 70 °C, please consult your regional sales office.

(3) Up to 100 A.



# Characteristics - TeSys GV4 - 0.25 to 55 kW

## TeSys protection components

### Motor circuit breakers TeSys GV4

#### Mounting characteristics

Operating position  
Without derating, in relation to normal vertical mounting plane <sup>(1)</sup>

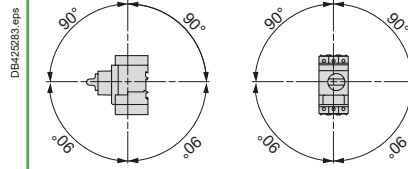

#### Power connection characteristics

##### Power connection by bare cables (EverLink connector)

Bare cables

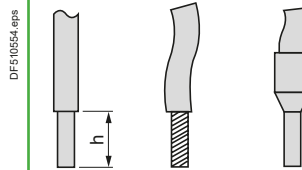

		Min.	Max.
Connection to screw clamp terminals (Max. number of conductors x c.s.a.)	Solid cable	<b>mm<sup>2</sup></b> Cu 1 x 1.5 + 1 x 2.5 <b>AWG</b> Cu 2 x 14	Cu 1 x 70 + 1 x 95 Cu 1 x 2/0 + 1 x 3/0
	Flexible cable without cable end	<b>mm<sup>2</sup></b> Cu 1 x 1.5 + 1 x 2.5 <b>AWG</b> Cu 2 x 6	Cu 1 x 50 + 1 x 70 Cu 1 x 1/0 + 1 x 2/0
	Flexible cable with cable end	<b>mm<sup>2</sup></b> Cu 1 x 1.5 + 1 x 2.5 <b>AWG</b> Cu 2 x 6	Cu 1 x 50 + 1 x 70 Cu 1 x 1/0 + 1 x 2/0
Tightening torque		<b>N.m</b> 5 ≤ 10 mm <sup>2</sup> / 8 AWG 9 ≥ 16 mm <sup>2</sup> / 6 AWG	
Stripping length (h)	Solid cable	<b>mm</b> 20	

##### Power connection by bars or lugs

Bars or lugs

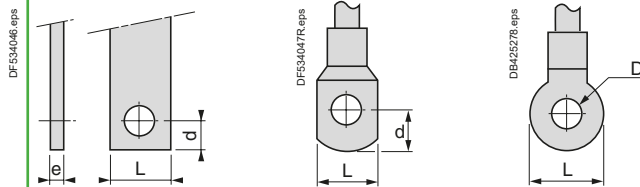

Pitch	Without spreaders	<b>mm</b>	27
	With spreaders	<b>mm</b>	35
Bars or cables with lugs	e	<b>mm</b>	≤ 8
	L	<b>mm</b>	≤ 20
	d	<b>mm</b>	≤ 7
	D	<b>mm</b>	6.4
M6 Screws	Tightening torque	<b>N.m</b>	5 ≤ 10 mm <sup>2</sup> / 8 AWG 9 ≥ 16 mm <sup>2</sup> / 6 AWG

<sup>(1)</sup> When mounting on a vertical rail, fit a stop to prevent any slippage.

Circuit breakers

# Characteristics - TeSys GV4 - 0.25 to 55 kW

## TeSys protection components

### Magnetic motor circuit breakers GV4L and GV4LE

Breaking capacity of GV4L and GV4LE																							
Circuit breaker type			GV4L●●●B GV4LE●●●B				GV4L●●●N GV4LE●●●N								GV4LE●●●S								
Rating			A	25	50	80	115	2	3.5	7	12.5	25	50	80	115	2	3.5	7	12.5	25	50	80	115
Breaking capacity conforming to IEC 60947-2	230/240 V	lcu	kA	50				100								120							
		ics % <sup>(1)</sup>		100				100								100							
	400/415 V	lcu	kA	25				50								100							
		ics % <sup>(1)</sup>		100				100								100							
	440 V	lcu	kA	20				50								70							
		ics % <sup>(1)</sup>		100				100								100							
	500 V	lcu	kA	10				25								30							
		ics % <sup>(1)</sup>		100				100								100							
	525 V	lcu	kA	-				15								18							
		ics % <sup>(1)</sup>		-				100								100							
	690 V	lcu	kA	-				8								10							
		ics % <sup>(1)</sup>		-				25								25							

(1) As % of lcu.

# Characteristics - TeSys GV4 - 0.25 to 55 kW

## TeSys protection components

Thermal-magnetic motor circuit breakers GV4P, GV4PE, GV4PEM and GV4PB

Breaking capacity of GV4P, GV4PE, GV4PB●●●B																						
Circuit breaker type			GV4P●●●B GV4PE●●●B GV4PEM●●●B GV4PB●●●B				GV4P●●●N GV4PE●●●N GV4PEM●●●N GV4PB●●●N				GV4P●●●S GV4PE●●●S GV4PEM●●●S GV4PB●●●S											
Rating		A	25	50	80	115	2	3.5	7	12.5	25	50	80	115	2	3.5	7	12.5	25	50	80	115
Breaking capacity conforming to IEC 60947-2	230/240 V	Icu	kA	50				100				120										
		Ics % <sup>(1)</sup>		100				100				100										
	400/415 V	Icu	kA	25				50				100										
		Ics % <sup>(1)</sup>		100				100				100										
	440 V	Icu	kA	20				50				70										
		Ics % <sup>(1)</sup>		100				100				100										
	500 V	Icu	kA	10				25				30										
		Ics % <sup>(1)</sup>		100				100				100										
	525 V	Icu	kA	-				15				18										
		Ics % <sup>(1)</sup>		-				100				100										
	690 V	Icu	kA	-				8				10										
		Ics % <sup>(1)</sup>		-				25				25										
Breaking capacity conforming to UL 60947-4-1 and CSA 22.2 n° 60947-4-1	120 V		kA	35				65				100										
	208 V		kA	35				65				100										
	240 V		kA	35				65				100										
	480Y / 277 V		kA	18				35				65										
	480 V <sup>(2)</sup>		kA	18				35				65										
	600Y / 347 V		kA	14				18				25										
	600 V <sup>(2)</sup>		kA	14				18				25										

(1) As % of Icu.

(2) Except for MCC suitable for TAP conductor protection, in motor group installation and GV4PB.

Circuit breakers

# Curves - TeSys GV4 - 0.25 to 55 kW

## TeSys protection components

### Magnetic motor circuit breakers GV4L, GV4LE

#### Tripping curves for GV4L and GV4LE combined with thermal overload relay LRD or LR9

Average operating times at 20 °C related to multiples of the setting current

GV4L02 and GV4LE02 to 12 with LRD05 to LRD14,  
GV4L80 and GV4LE80 with LRD3363

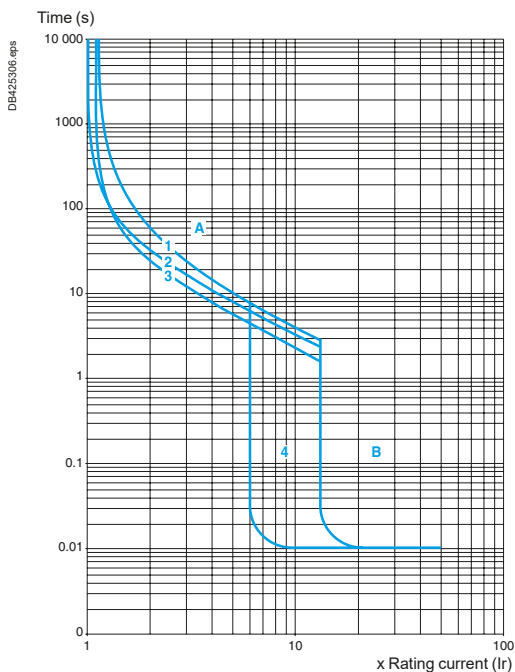

- 1 3 poles from cold state
  - 2 2 poles from cold state
  - 3 3 poles from hot state
  - 4 6 ... 14 Ir
- A Thermal overload relay protection zone
  - B GV4L protection zone

GV4L25 AND GV4LE25 with LRD 318, LRD325  
GV4L50 AND GV4LE50 with LRD 332, LRD 340, LRD 350

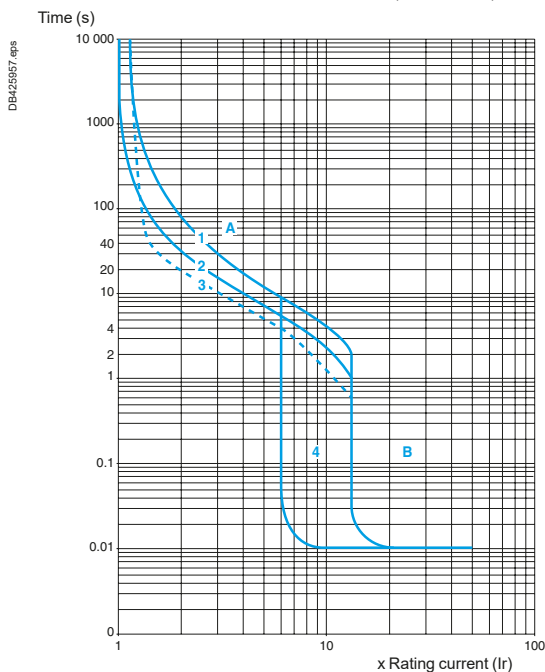

- 1 3 poles from cold state
  - 2 2 poles from cold state
  - 3 3 poles from hot state
  - 4 6 ... 14 Ir
- A Thermal overload relay protection zone
  - B GV4L protection zone

GV4L115 and GV4LE115 with class 10 LR9F5367, LR9D5369  
and class 20 LR9D5567, LR9F5569

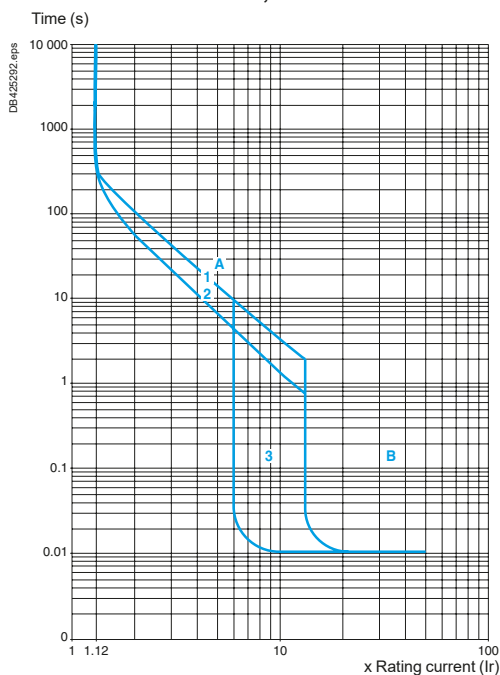

- 1 Cold state curve
- 2 Hot state curve
- 3 6 ... 14 Ir

Circuit breakers

## Curves - TeSys GV4 - 0.25 to 55 kW

### TeSys protection components

#### Magnetic motor circuit breakers GV4L, GV4LE

#### Current limitation on short-circuit for GV4L, GV4LE (3-phase 400/415 V)

##### Dynamic stress

$I_{peak} = f(\text{prospective } I_{sc}) \text{ at } 1.05 U_e = 435 \text{ V}$

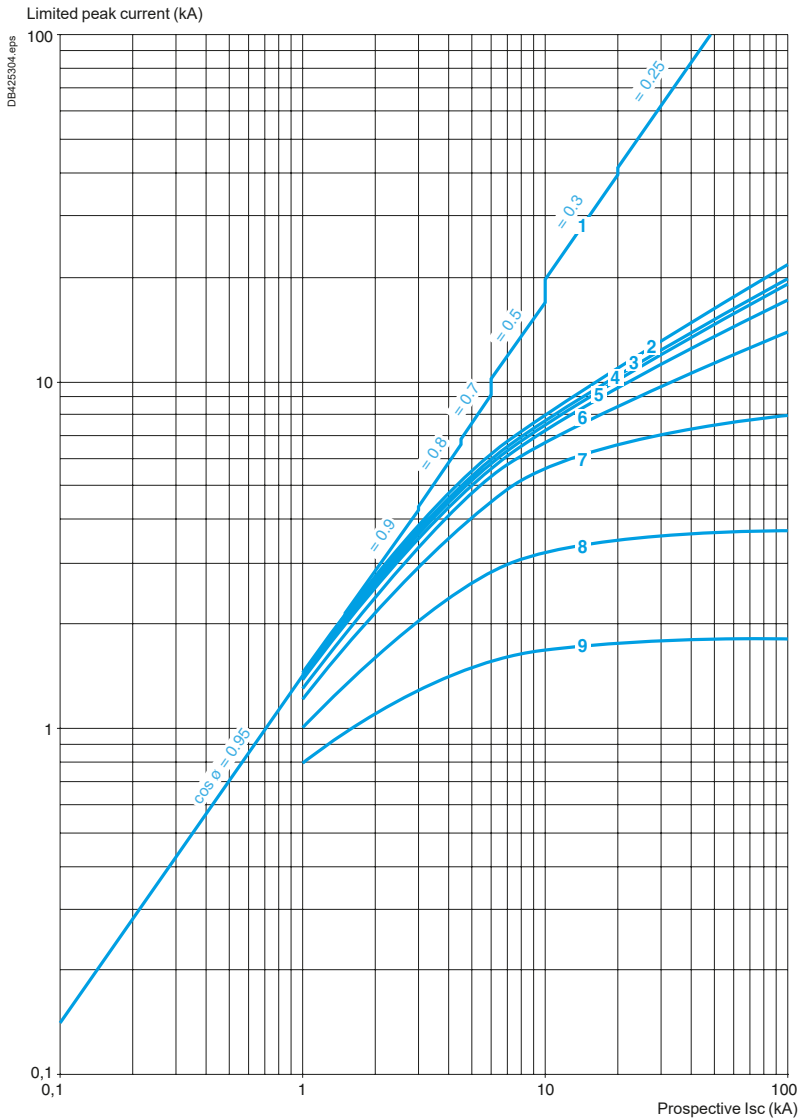

- 1 Maximum peak current
- 2 GV4L115
- 3 GV4L80
- 4 GV4L50
- 5 GV4L25
- 6 GV4L12
- 7 GV4L07
- 8 GV4L03
- 9 GV4L02

## Curves - TeSys GV4 - 0.25 to 55 kW

### TeSys protection components

Magnetic motor circuit breakers GV4L, GV4LE

#### Current limitation on short-circuit for GV4L, GV4LE + thermal overload relay LRD or LR9 (3-phase 400/415 V)

##### Dynamic stress

$I_{peak} = f(\text{prospective } I_{sc})$  at  $1.05 U_e = 435 \text{ V}$

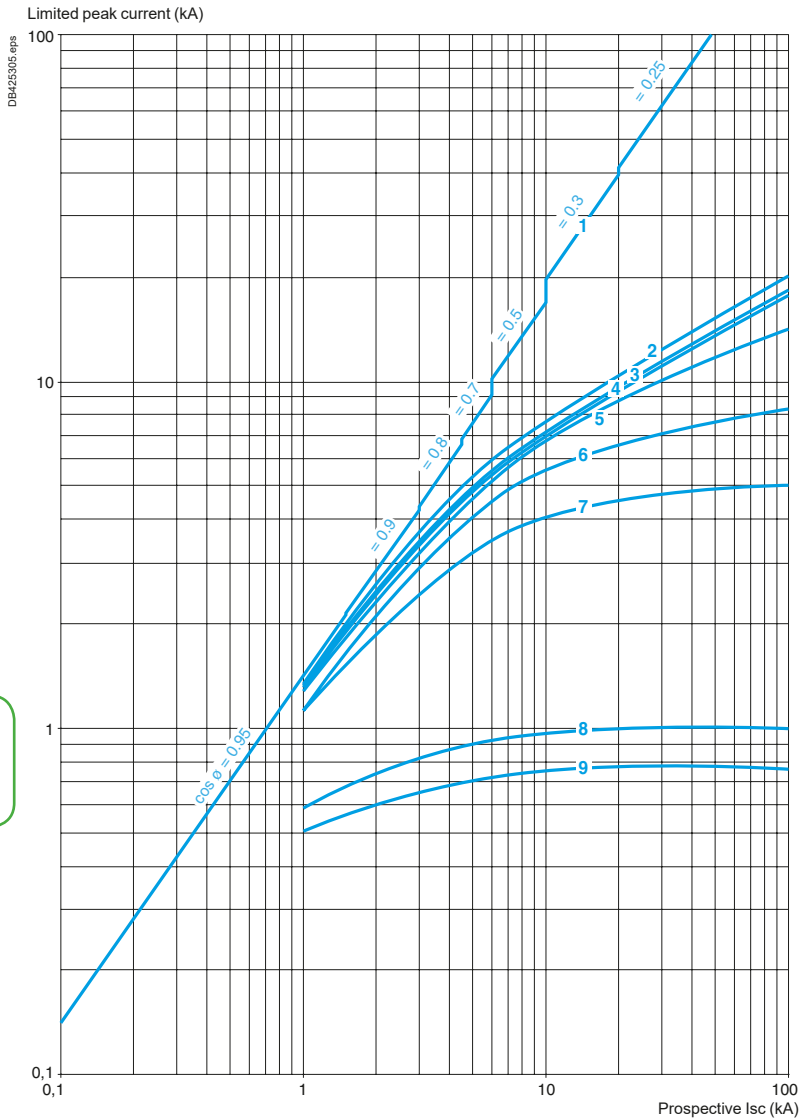

- 1 Maximum peak current
- 2 GV4L115 + LR9D5367 or LR9F5367
- 3 GV4L80 + LRD3361
- 4 GV4L50 + LRD340
- 5 GV4L25 + LRD325
- 6 GV4L12 + LRD313
- 7 GV4L07 + LRD12
- 8 GV4L03 + LRD07
- 9 GV4L02 + LRD07

# TeSys protection components

Magnetic motor circuit breakers GV4L, GV4LE

## Thermal limit on short-circuit for GV4L, GV4LE

Thermal limit in A<sup>2</sup>s

Sum of I<sup>2</sup>dt = f (prospective I<sub>sc</sub>) at 1.05 U<sub>e</sub> = 435 V

Sum of I<sup>2</sup>dt (A<sup>2</sup>s)

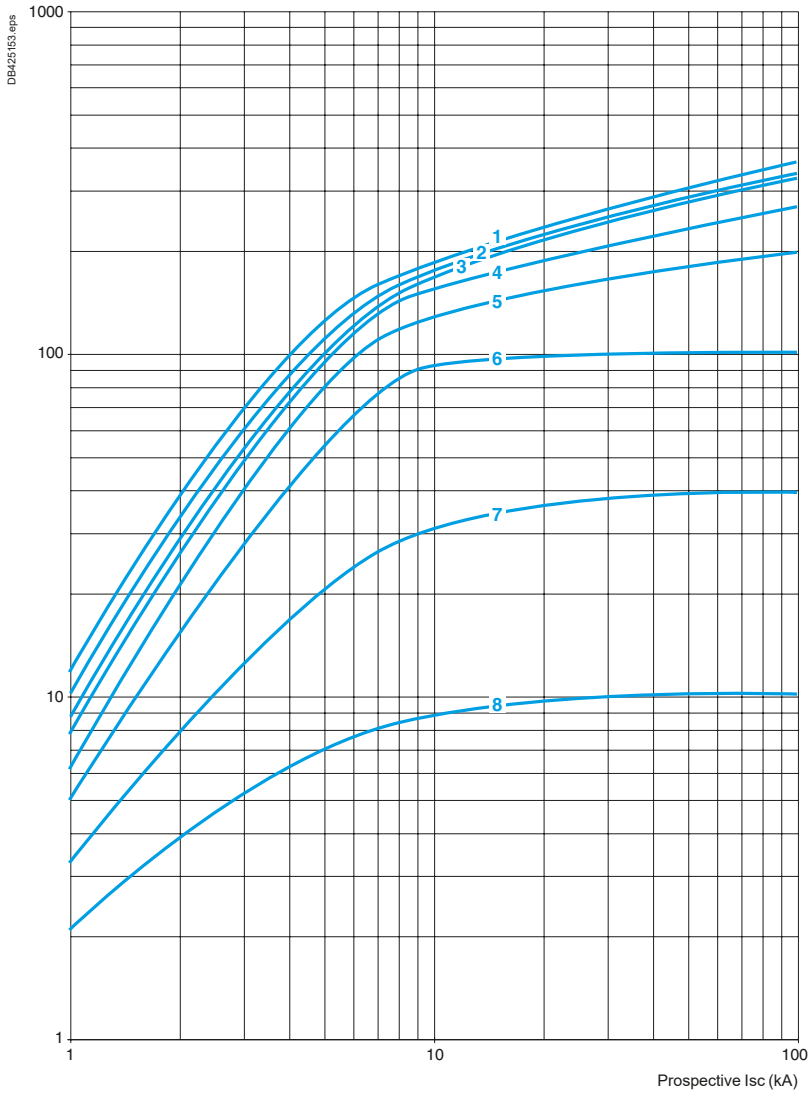

- 1 GV4L115
- 2 GV4L80
- 3 GV4L50
- 4 GV4L25
- 5 GV4L12
- 6 GV4L07
- 7 GV4L03
- 8 GV4L02

Circuit breakers

## TeSys protection components

Magnetic motor circuit breakers GV4L, GV4LE

### Thermal limit on short-circuit for GV4L, GV4LE + thermal overload relay LRD or LR9

Thermal limit in kA in the magnetic operating zone

Sum of  $I^2dt = f$  (prospective  $I_{sc}$ ) at  $1.05 U_e = 435 V$

Sum of  $I^2dt$  (A<sup>2</sup>s)

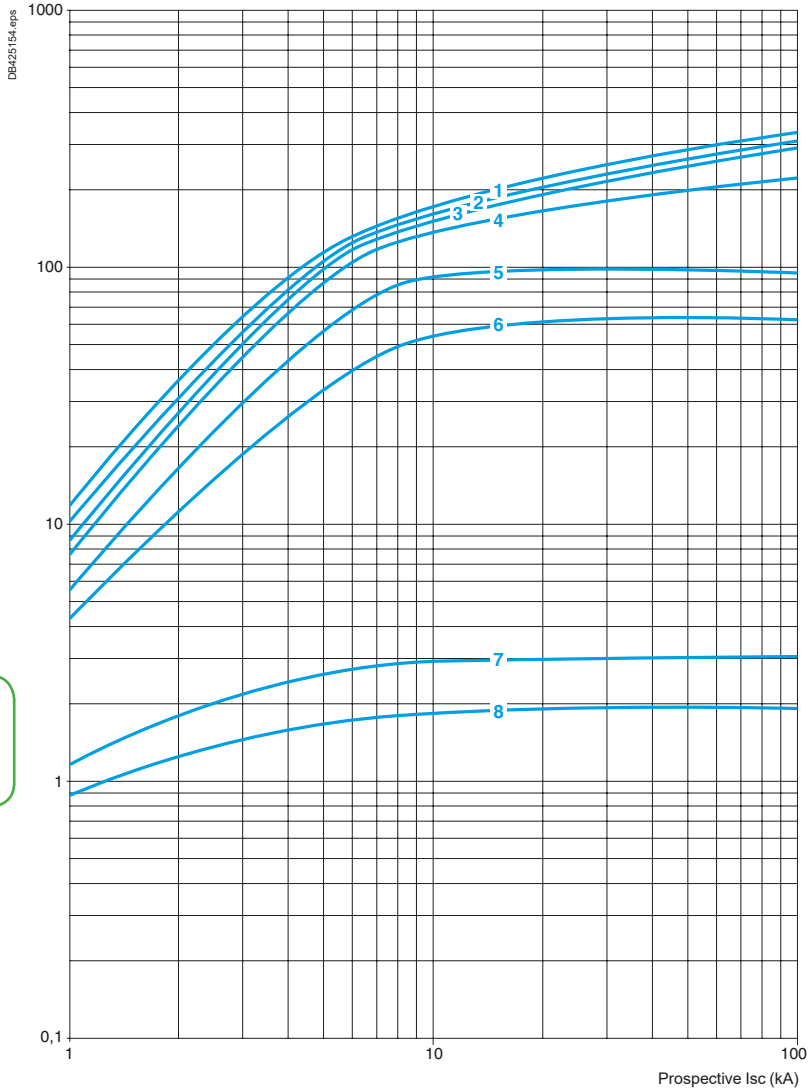

- 1 GV4L115 + LR9D5367 or LR9F5367
- 2 GV4L80 + LRD3361
- 3 GV4L50 + LRD340
- 4 GV4L25 + LRD325
- 5 GV4L12 + LRD313
- 6 GV4L07+ LRD12
- 7 GV4L03+ LRD07
- 8 GV4L02 + LRD07



# Curves - TeSys GV4 - 0.25 to 55 kW

## TeSys protection components

Thermal-magnetic motor circuit breakers GV4P, GV4PE, GV4PEM, GV4PB

### Thermal-magnetic tripping curves for GV4P, GV4PE, GV4PEM, GV4PB

Average operating times at 20 °C related to multiples of the setting current

#### GV4P, GV4PE, GV4PEM

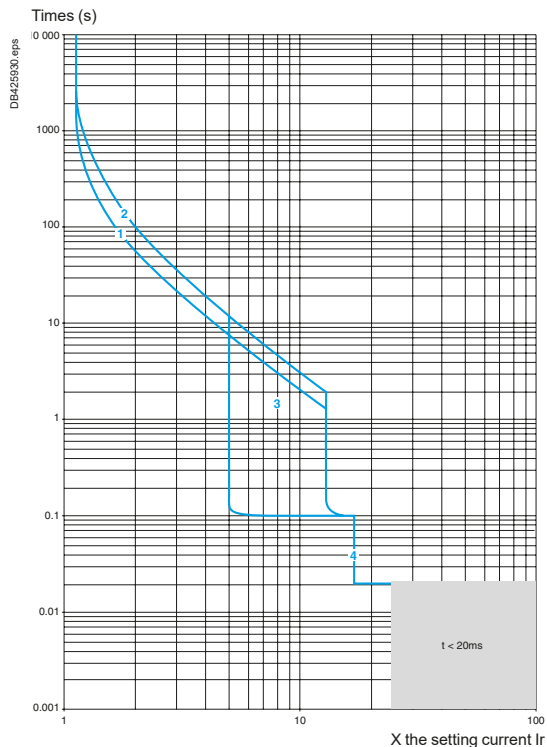

#### GV4P, GV4PE, GV4PEM

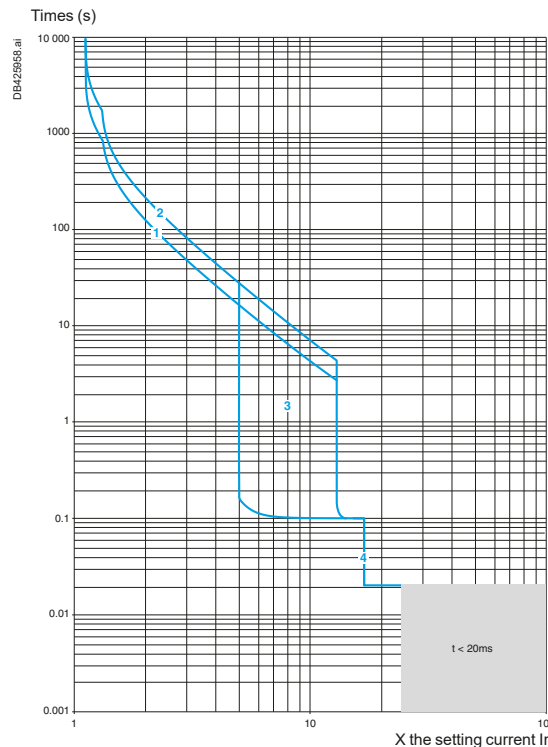

#### GV4PB

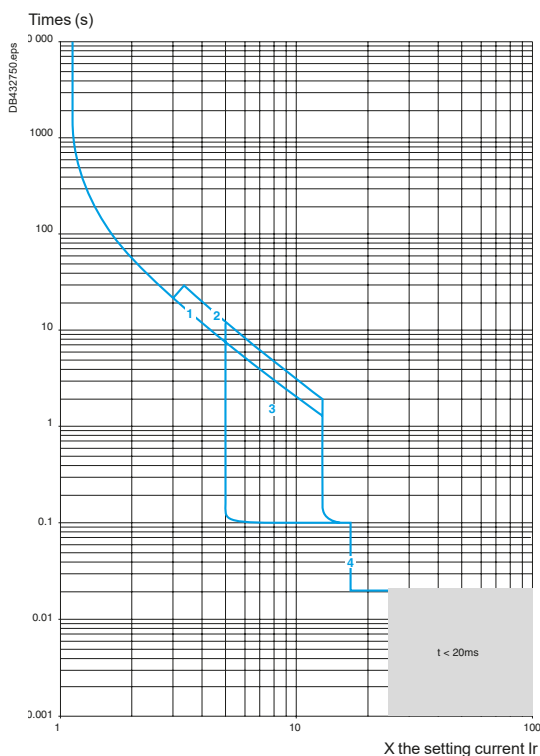

#### GV4PB

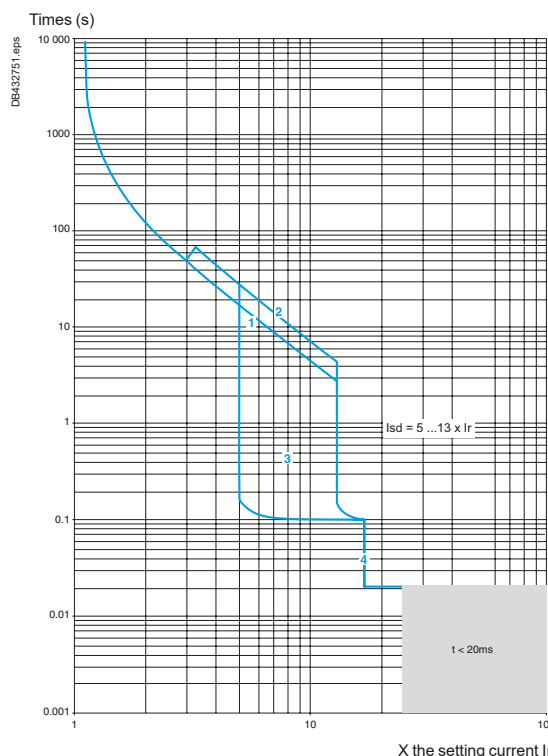

#### Hot state

- 1 Class 10
- 2 Class 20
- 3 Isd = 13 x Ir (GV4P - GV4PE); Isd = 5 ... 13 x Ir (GV4PEM - GV4PB)
- 4 Ii = 17 In

#### Cold state

- 1 Class 10
- 2 Class 20
- 3 Isd = 13 x Ir (GV4P - GV4PE); Isd = 5 ... 13 x Ir (GV4PEM - GV4PB)
- 4 Ii = 17 In

References:  
pages B6/31 to B6/48

Characteristics:  
pages B6/112 to B6/124

Dimensions:  
pages B6/126 to B6/128

Circuit breakers

## Curves - TeSys GV4 - 0.25 to 55 kW

### TeSys protection components

Thermal-magnetic motor circuit breakers GV4P, GV4PE, GV4PEM, GV4PB

#### Current limitation on short-circuit for GV4P, GV4PE, GV4PEM, GV4PB (3-phase 400/415 V)

##### Dynamic stress

$I_{peak} = f(\text{prospective } I_{sc}) \text{ at } 1.05 U_e = 435 \text{ V}$

Limited peak current (kA)

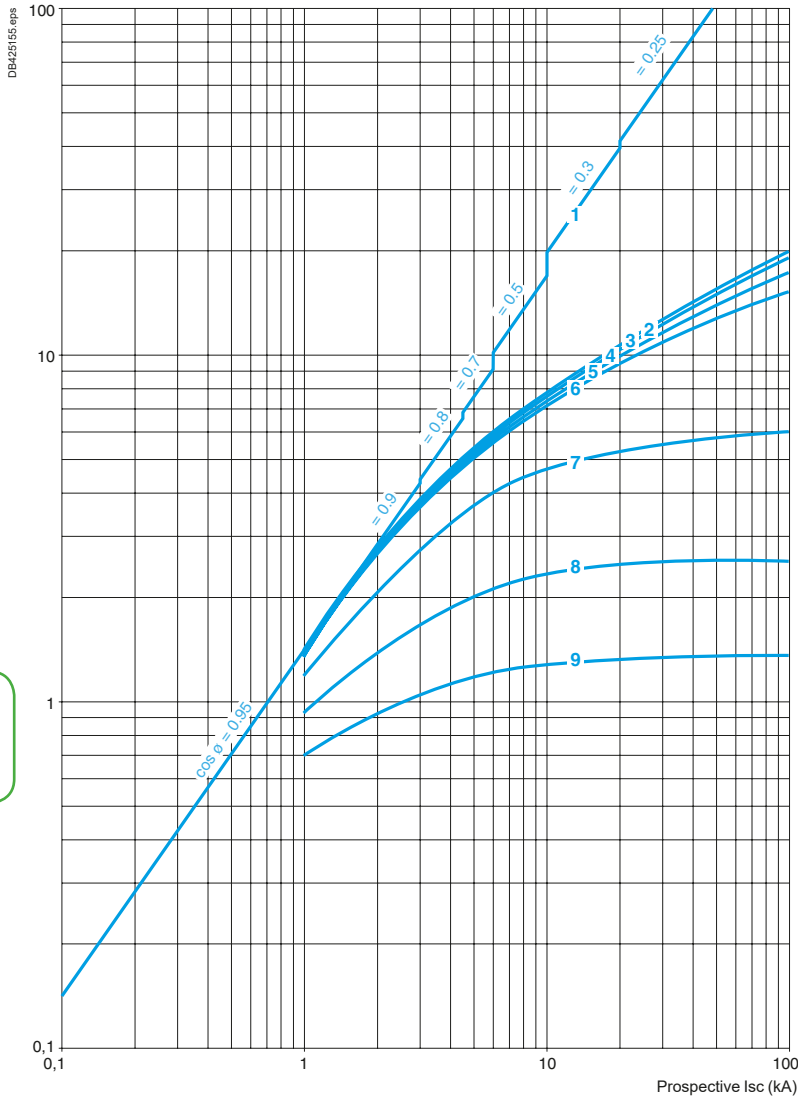

- 1 Maximum peak current
- 2 GV4P115
- 3 GV4P80
- 4 GV4P50
- 5 GV4P25
- 6 GV4P12
- 7 GV4P07
- 8 GV4P03
- 9 GV4P02

## Curves - TeSys GV4 - 0.25 to 55 kW

### TeSys protection components

Thermal-magnetic motor circuit breakers GV4P, GV4PE, GV4PEM, GV4PB

#### Thermal limit on short-circuit for GV4P, GV4PE, GV4PEM, GV4PB

##### Thermal limit in kA<sup>2</sup>s in the magnetic operating zone

Sum of  $I^2dt = f$  (prospective  $I_{sc}$ ) at  $1.05 U_e = 435 V$

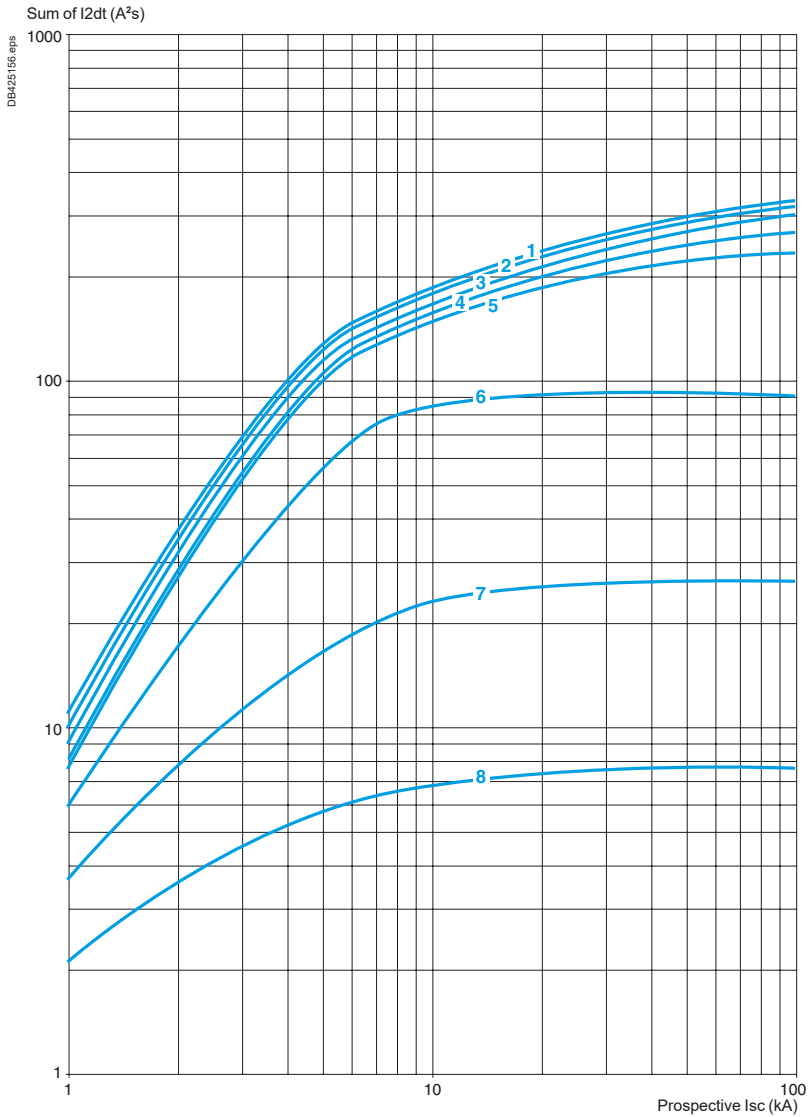

- 1 GV4P115
- 2 GV4P80
- 3 GV4P50
- 4 GV4P25
- 5 GV4P12
- 6 GV4P07
- 7 GV4P03
- 8 GV4P02

## TeSys protection components

Thermal-magnetic motor circuit breakers

Voltage releases

Characteristics of electric trips			GV4AU●●● MN (undervoltage release)						
Type of trip			GV4AU●●● MN (undervoltage release)						
Rated insulation voltage (Ui)	Conforming to IEC 60947-1	V	= Ue						
Operational voltage (Ue)	Conforming to IEC 60947-1	V	24 V AC/DC	48 V AC/DC	110-130 V AC 125 V DC	208-240 V 60 Hz 220-240 V 50 Hz	277 V 60 Hz	380-415 V 60 Hz	440-480 V 60 Hz
Inrush consumption	~	VA	< 7 VA < 2 W	< 7 VA < 2 W	< 7 VA < 2 W	< 7 VA	< 7 VA	< 7 VA	< 7 VA
Sealed consumption	~	VA	< 7 VA < 2 W	< 7 VA < 2 W	< 7 VA < 2 W	< 7 VA	< 7 VA	< 7 VA	< 7 VA
Operating time	Conforming to IEC 60947-1	ms	< 50						
On-load factor			100 %						
Cabling (spring connection)	Number of conductors		1 per terminal						
	Solid cable	mm <sup>2</sup>	No solid cable allowed						
	Flexible cable without cable end	mm <sup>2</sup> AWG	Cu 0.5 mm <sup>2</sup> to 1.5 mm <sup>2</sup> Cu 20AWG to 16AWG						
	Flexible cable with cable end	mm <sup>2</sup>	No cable with cable end allowed						
Tightening torque		N.m	NA						
Mechanical durability (C.O.: Close - Open)		C.O.	20000						

Characteristics of electric trips			GV4AS●●● MX (Shunt trip)				
Type of trip			GV4AS●●● MX (Shunt trip)				
Rated insulation voltage (Ui)	Conforming to IEC 60947-1	V	= Ue				
Operational voltage (Ue)	Conforming to IEC 60947-1	V	24 V AC/DC	48 V AC/DC	110-130 V AC 125 V DC	208-240 V 60 Hz 220-240 V 50 Hz	380-415 V 50 Hz 440-480 V 60 Hz
Inrush consumption	~	VA	< 6 VA < 10 W	< 6 VA < 10 W	< 6 VA < 10 W	< 6 VA	< 6 VA
Sealed consumption	~	VA	< 4 VA < 1 W	< 4 VA < 1 W	< 4 VA < 1 W	< 4 VA	< 4 VA
Operating time	Conforming to IEC 60947-1	ms	< 50				
On-load factor			100 %				
Cabling (spring connection)	Number of conductors		1 per terminal				
	Solid cable	mm <sup>2</sup>	No solid cable allowed				
	Flexible cable without cable end	mm <sup>2</sup> AWG	Cu 0.5 mm <sup>2</sup> to 1.5 mm <sup>2</sup> Cu 20AWG to 16AWG				
	Flexible cable with cable end	mm <sup>2</sup>	No cable with cable end allowed				
Tightening torque		N.m	NA				
Mechanical durability (C.O.: Close - Open)		C.O.	20000				

## TeSys protection components

Thermal-magnetic motor circuit breakers GV4L, GV4P, GV4PE, GV4PEM, GV4PB  
Auxiliary contacts

Auxiliary contact characteristics														
Type of contacts			Auxiliary contact block GV4AE11						SDx contact module for GV4PEM, GV4PB, GV4ADM1111					
Rated insulation voltage (Ui)	Conforming to IEC 60947-1	V	690						250					
	Conforming to CSA C22-2 n°14 UL 508	V	-						-					
Conventional thermal current (Ith)	Conforming to IEC 60947-5-1	A	5						5					
	Conforming to CSA C22-2 n°14 UL 508	A	5						5					
Mechanical durability (C.O.: Close - Open)		C.O.	40 000						100 000					
Operational power and current conforming to IEC 60947-5-1 a.c. operation	<b>Rated operational voltage (Ue)</b>	V	24	48	110/127	230/240	380/440	660/690	48	110	230/240	380/415	440	690
	Operational power (AC12)	VA	120	240	635	1200	2200	3450			400			
	Occasional breaking and making capacities	kVA	1.2	2.4	6.35	12	22	34.5						
	Operational current (Ie)	AC-12	A	5	5	5	5	5	5					
		AC-15	A	5	5	4	3	2.5	0.1		3	1.5		
Operational power and current conforming to IEC 60947-5-1 d.c. operation	<b>Rated operational voltage (Ue)</b>	V	24	48	110	250			24	48	60	110	250	
	Operational power (DC12)	W	120	120	66	75			50					
	Occasional breaking and making capacities	W	1200	1200	660	750								
	Rated operational current (Ie)	DC-12	A	5	2.5	0.6	0.3							
		DC-13	A	2.5	1.2	0.35	0.05			2			0.22	0.11
DC-14		A	1	0.2	0.05	0.03								
Low power switching reliability of contact			10 <sup>-6</sup> at 17 V / 2 mA											
Minimum operational conditions d.c. operation		V	17											
		mA	2											
Short-circuit protection			5 A fuse gG conforming to IEC 60947-5-1											
Spring terminals cabling	Number of conductors		1 per hole											
	Solid cable	mm <sup>2</sup>	-						0.2 to 1.5					
	Flexible cable without cable end	mm <sup>2</sup>	0.5 to 1.5						0.2 to 2.5					
	Flexible cable with cable end	mm <sup>2</sup>	-						0.25 to 1.5					

Circuit breakers

# Dimensions, mounting - TeSys GV4 - 0.25 to 55 kW

## TeSys protection components

### Motor circuit breakers TeSys GV4

#### GV4 with toggle: GV4LE, GV4PE, GV4PEM, GV4PB

With EverLink® connector

With crimp lug connector

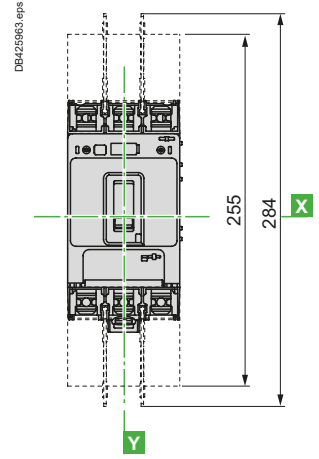
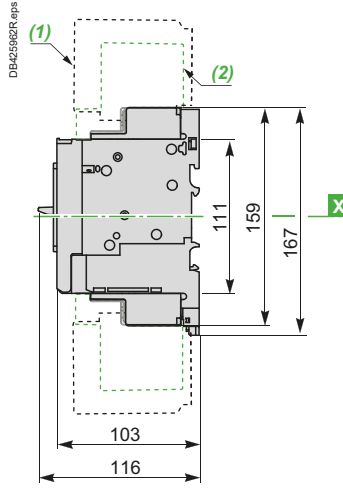
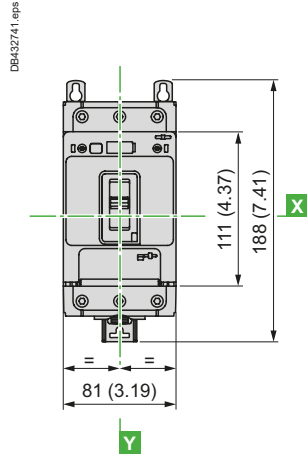
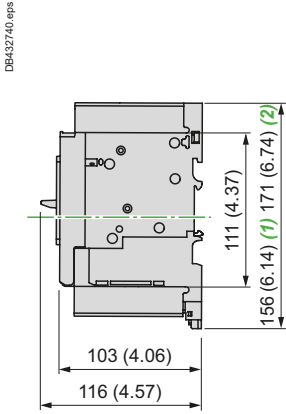

- (1) GV4LE, GV4PE, GV4PEM.
- (2) GV4PB.

- (1) Interphase barriers.
- (2) Long terminal shield.

#### GV4 with rotary handle: GV4L, GV4P, or GV4LE, GV4PE, GV4PEM, GV4PB with GV4ADN01, GV4ADN02 direct mounting rotary handle

Dimensions

Circuit breakers

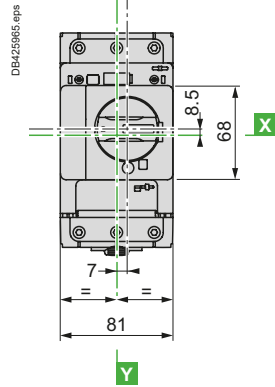
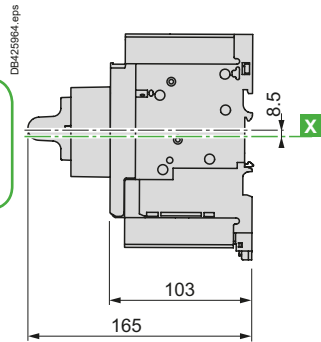

#### SDx module

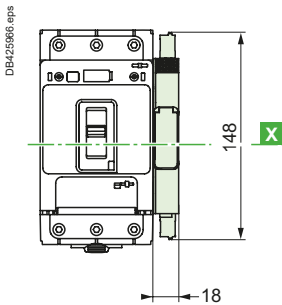

# Dimensions, mounting - TeSys GV4 - 0.25 to 55 kW

## TeSys protection components

### Motor circuit breakers TeSys GV4

#### GV4L, GV4P, GV4LE, GV4PE, GV4PEM, GV4PB

##### Panel mounting with M4 screws

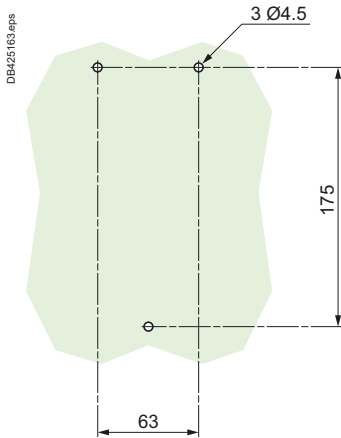

##### Door cut-out for rotary handle

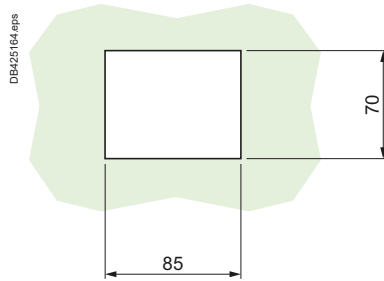

##### Minimum safety clearance

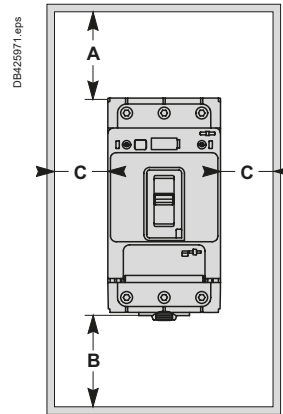

Toggle-type, rotary handle-type:  
identical clearance values.

##### Safety clearance (mm)

	Painted sheet metal			Bare sheet metal		
	A	B	C	A	B	C
No accessory	30	0	0	40	0	5
Interphase barriers	0	0	0	0	0	5
Long terminal shield	0	0	0	0	0	5

# Dimensions, mounting - TeSys GV4 - 0.25 to 55 kW

## TeSys protection components

### Motor circuit breakers TeSys GV4

#### GV4 with extended rotary handle

Front extended rotary handle GV4APN01, GV4APN02, GV4APN04

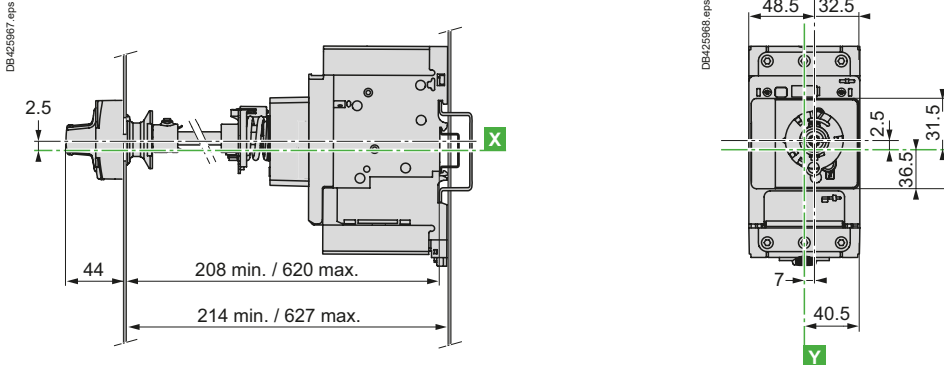

#### Side (left or right) extended rotary handle LV426935, LV426936

Circuit breakers

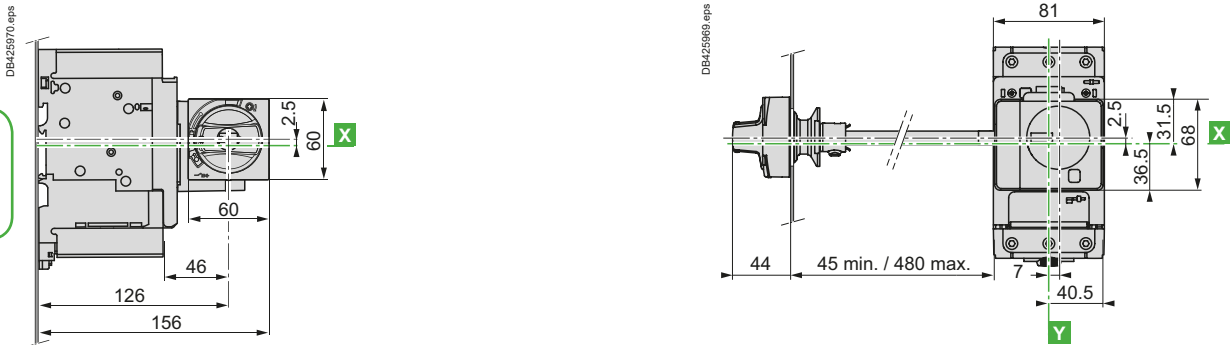

#### Front and side extended rotary handle, door/side panel cut-out

Front and side extended rotary handle

IP65, door panel cut-out

IP54, door/side panel cut-out

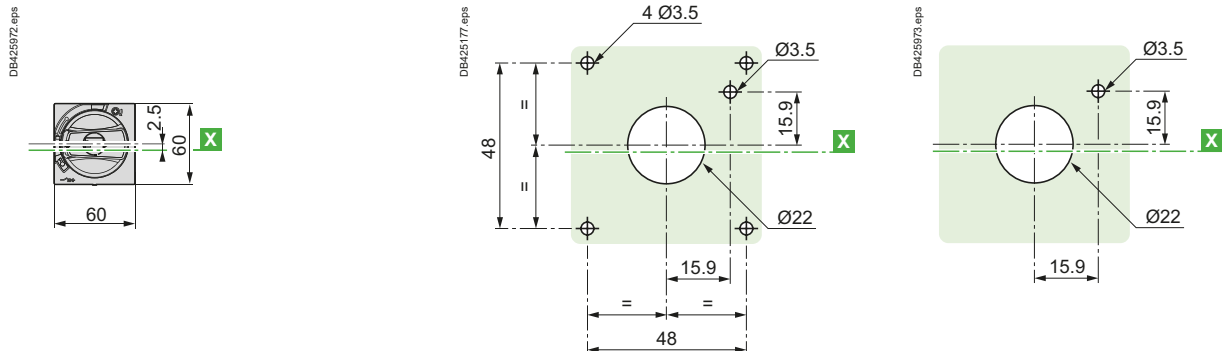



# Schemes - TeSys GV4 - 0.25 to 55 kW

## TeSys protection components

### Motor circuit breakers TeSys GV4

#### Magnetic motor circuit breakers

##### GV4L, GV4LE

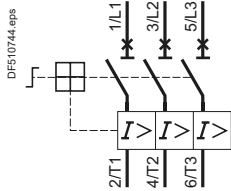

##### GV4P, GV4PE, GV4PEM, GV4PB

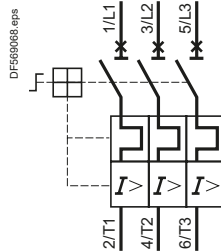

#### Accessories

##### Electrical trips

###### MN GV4AU●●●

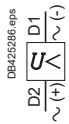

###### MX GV4AS●●●



##### GV4AE11 auxiliary contacts

###### Used as OF contact



###### Used as SD contact



#### Side mounting add-on contact blocks

##### Instantaneous auxiliary contacts and fault signalling contacts

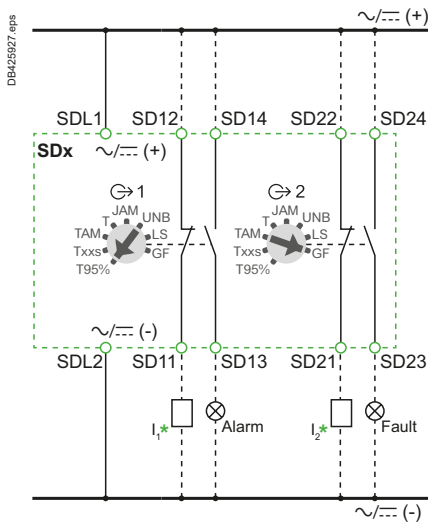

\* I1, I2: PLC digital inputs - used as alarm inputs, as an example.

Circuit breakers



# TeSys GV5/GV6

55 to 250 kW



Circuit  
breakers

# Characteristics - TeSys GV5 and GV6 - 55 to 250 kW

## TeSys protection components

### Thermal-magnetic motor circuit breakers GV5P and GV6P

Environment							
<b>Circuit breaker type</b>		<b>GV5P/ GV6P</b>					
Conforming to standards		IEC/EN 60947-4-1 IEC/EN 60947-2 UL 60947-4-1 CSA C22.2 n° 60947-4-1					
Product certifications		CB, CCC, UL, CSA, EAC, DNV -GL					
Climatic withstand		According to IACS E10					
Degree of protection (front face)	Conforming to IEC 60529	Bare circuit breaker with terminal shields Installed in switchboard	IP40 with direct rotary handle				
Shock resistance	Conforming to IEC 60068-2-27		15 gn -11 ms				
Vibration resistance	Conforming to IEC 60068-2-6		2.5 gn (25 Hz)				
Ambient air temperature	Storage in packing		°C	-50...+85			
	Operation	Open mounted	°C	-25... +70			
		In enclosure	°C	-25...+70			
Flame resistance	Conforming to IEC 60695-2-11		°C	960			
Maximum operating altitude			m	2000			
Suitable for isolation	Conforming to IEC 60947-1 § 7-1-6		Yes				
Resistance to mechanical impact			J	0.5			
Sensitivity to phase failure			Yes				
Technical characteristics							
<b>Circuit breaker type</b>		<b>GV5P150</b>	<b>GV5P220</b>	<b>GV6P320</b>	<b>GV6P500</b>		
Utilisation category	Conforming to IEC 60947-2		A				
	Conforming to IEC 60947-4-1		AC-3				
Rated operational voltage (Ue)	Conforming to IEC 60947-2		V	690			
Rated insulation voltage (Ui)	Conforming to IEC 60947-2		V	800			
Rated voltage	Conforming to UL 60947-4-1, CSA C22.2 n° 60947-4-1		V	600			
Rated operational frequency	Conforming to IEC 60947-4-1 UL, CSA		Hz	50/60			
Rated impulse withstand voltage (U imp)	Conforming to IEC 60947-2		kV	8			
Total power dissipated per pole			W	9.2	17.6	19.2	39.7
Mechanical durability (C.O.: Close, Open)			C.O.	40 000	20 000	15 000	15 000
Electrical durability for AC-3 duty	400/415 V (In)		C.O.	20 000	10 000	6 000	4 000
Duty class (maximum operating rate)			C.O./h	25			
Maximum conventional rated thermal current (Ith)	Conforming to IEC 60947-4-1		A	70...150	100...220	160...320	250...500
Rated duty	Conforming to IEC 60947-4-1		Continuous duty				

Circuit breakers

# TeSys protection components

Thermal-magnetic motor circuit breakers GV5P and GV6P

## Thermal-magnetic tripping curves for GV5P

MicroLogic 2.2 M - 150/220 A

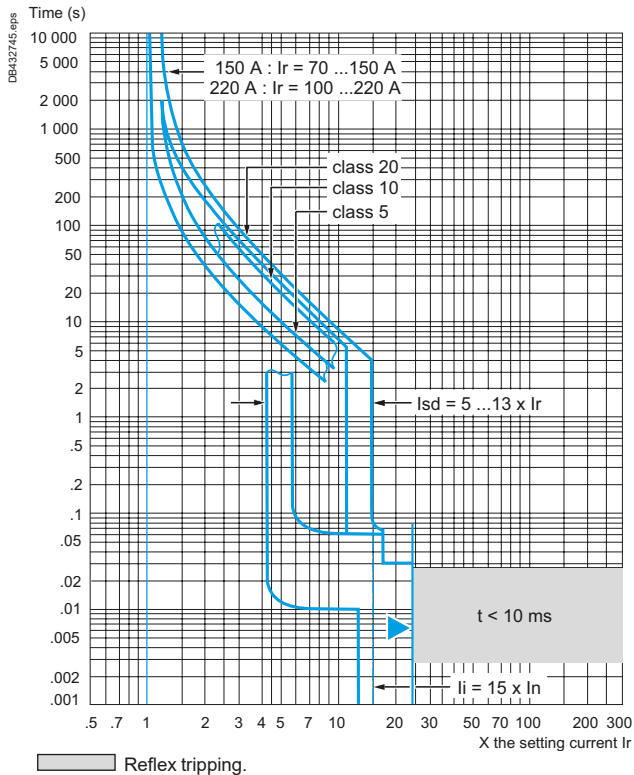

## Thermal-magnetic tripping curves for GV6P

MicroLogic 2.3 M - 320 A

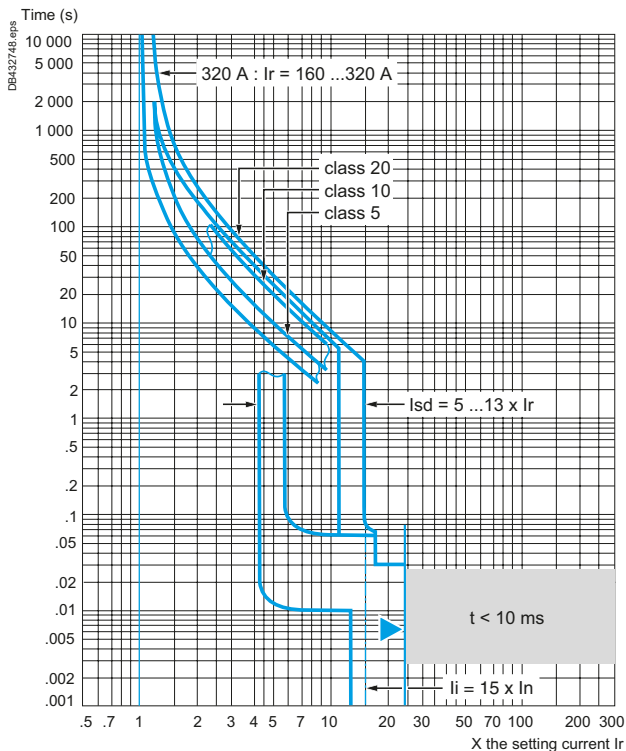

MicroLogic 2.3 M - 500 A

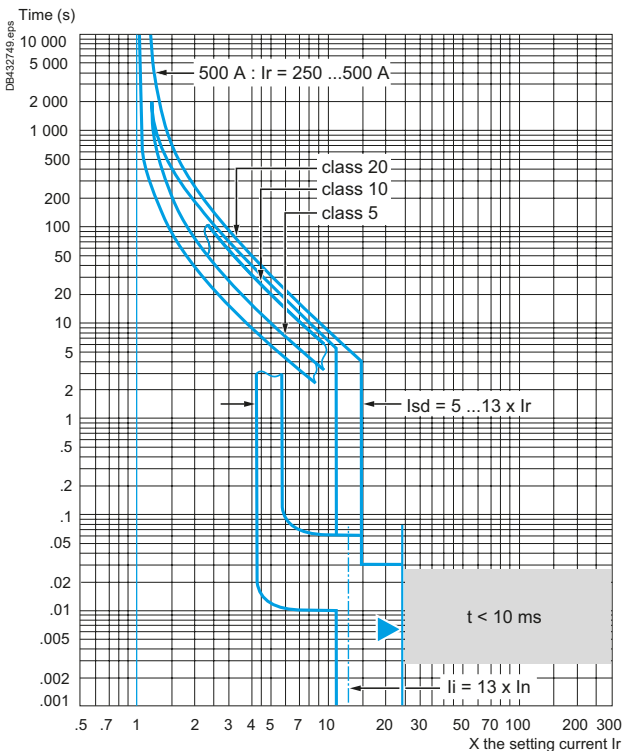

# Curves - TeSys GV5 and GV6 - 55 to 250 kW

## TeSys protection components

Thermal-magnetic motor circuit breakers GV5P and GV6P

### Current limitation on short-circuit (3-phase 400 - 415 V)

#### Dynamic stress

For GV5P/6P●●●F/H type

Limited peak current (kA)

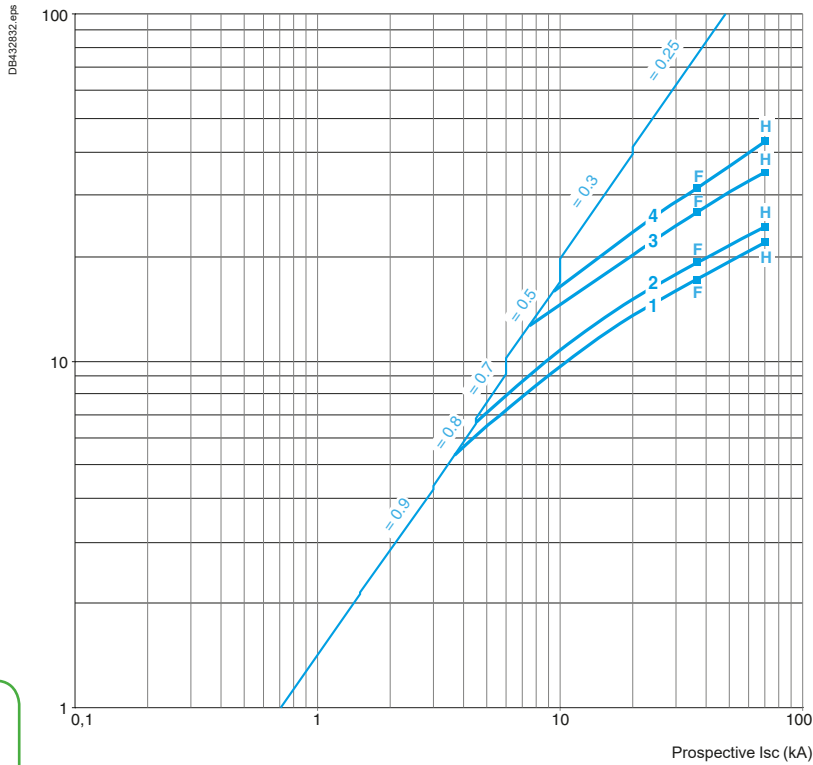

- 1 GV5P150F/H
- 2 GV5P220F/H
- 3 GV6P320F/H
- 4 GV6P500F/H

# TeSys protection components

Thermal-magnetic motor circuit breakers GV5P and GV6P

## Maximum thermal limit on short-circuit

Thermal limit in  $kA^2s$  in the magnetic operating zone

Sum of  $I^2dt = f(\text{prospective } I_{sc})$  at  $1.05 U_e = 435 V$

Sum of  $I^2dt$  ( $A^2s$ )

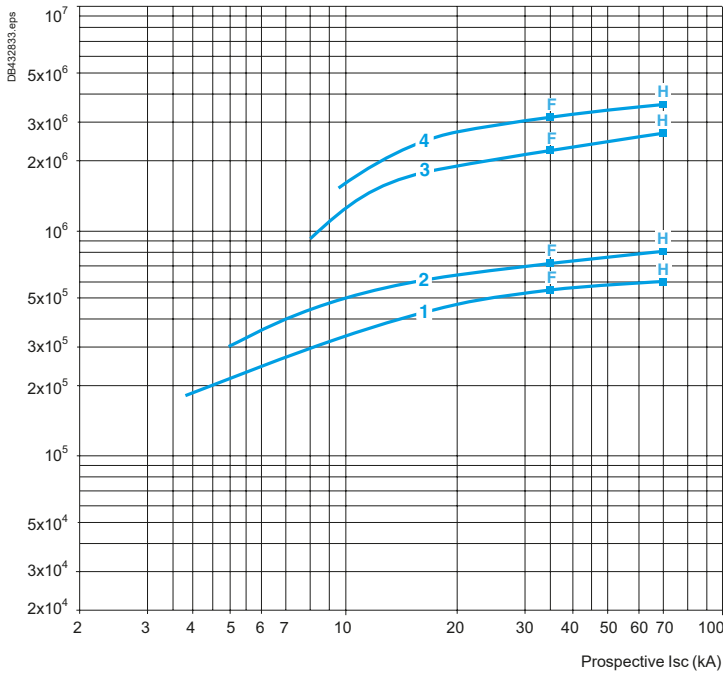

- 1 GV5P150F/H
- 2 GV5P220F/H
- 3 GV6P320F/H
- 4 GV6P500F/H

Circuit breakers

## TeSys protection components

### GV5P/GV6P motor circuit breakers

#### Electric trips

Characteristics of GV5P/GV6P electric trips				
Type of trip			GV7AU●●● undervoltage trip	GV7AS●●● shunt trip
Rated insulation voltage (Ui)	Conforming to IEC 60947-1	V	690	690
	Conforming to CSA C22-2 n°14, UL 508	V	600	600
Operational voltage (Ue)	Conforming to IEC 60947-1	V	0.85...1.1 Uc	0.7...1.1 Uc
Drop-out voltage		V	0.7...0.35 Uc	0.7...0.35 Uc
Inrush consumption	~	VA	< 10	
Sealed consumption	~	VA	< 5	
Operating time	Conforming to IEC 60947-1	ms	From the moment the voltage reaches its operational value until opening of the circuit breaker. < 50	
On-load factor			100 %	
Cabling (spring connection)	Number of conductors		1	
	Solid cable	mm <sup>2</sup>	1.5	
	Flexible cable without cable end	mm <sup>2</sup>	1.5	
	Flexible cable with cable end	mm <sup>2</sup>	1	
Tightening torque		N.m	1.2	
Mechanical durability (C.O.: Close - Open)		C.O.	50 % of the mechanical durability of the circuit breaker.	

Characteristics of GV5P/GV6P thermal fault module				
Type of trip			LV429424 <sup>(1)</sup>	
Operational voltage (Ue)	Conforming to IEC 60947-1	V	24 to 415 V AC/ DC	
Conventional thermal current (Ith)	Conforming to IEC 60947-5-1	A	80 mA max.	

(1) LV429424 takes the place of the AU/AS electric trip coil and an auxiliary contact.



## TeSys protection components

Thermal-magnetic motor circuit breakers GV5P and GV6P

Auxiliary contacts

Auxiliary contact characteristics													
Type of contacts			GV7AE11						GV7AB11				
Rated insulation voltage (Ui) (associated insulation coordination)	Conforming to IEC 60947-1	V	690						690				
Conventional thermal current (Ith)	Conforming to IEC 60947-5-1	A	6						5				
Mechanical durability (C.O.: Close - Open)		C.O.	50 000						50 000				
Operational current conforming to IEC 60947-5-1 a.c. operation	Rated operational voltage (Ue)	V	AC-12 or AC-15. 50 000 C.O.						AC-12 or AC-15. 50 000 C.O.				
		A	24	48	110	220/240	380/440	690	24	48	110	230/240	380/415
		Rated operational current (Ie)	AC-12	A	6	6	6	6	6	6	5	5	5
		A	6	6	5	4	2	0.1	3	3	2.5	2	1.5
Operational current conforming to IEC 60947-5-1 d.c. operation	Rated operational voltage (Ue)	V	DC-12 or DC-14. 50 000 C.O.				DC-12 or DC-14. 50 000 C.O.						
		A	24	48	110	250	24	48	110	250			
		Rated operational current (Ie)	DC-12	A	6	2.5	0.6	0.3	5	2.5	0.6	0.3	
		A	1	0.2	0.05	0.03	1	0.2	0.05	0.03			
Minimum operational conditions d.c. operation	V	24						4					
	mA	100						1					
Short-circuit protection			By <b>GB2CB●●</b> circuit breaker (rating according to operational current for Ue ≤ 415 V) or gG fuse, 10 A max.										
Cabling	Solid cable	mm <sup>2</sup>	1 x 1.5 conductor						1 x 1.5 conductor				
	Flexible cable without cable end	mm <sup>2</sup>	1 x 1.5 conductor						1 x 1.5 conductor				
	Flexible cable with cable end	mm <sup>2</sup>	1 x 1.5 conductor						1 x 1.5 conductor				

# Dimensions, mounting - TeSys GV5 and GV6 - 55 to 250 kW

## TeSys protection components

### Thermal-magnetic motor circuit breakers GV5P and GV6P

#### GV5P

##### Dimensions

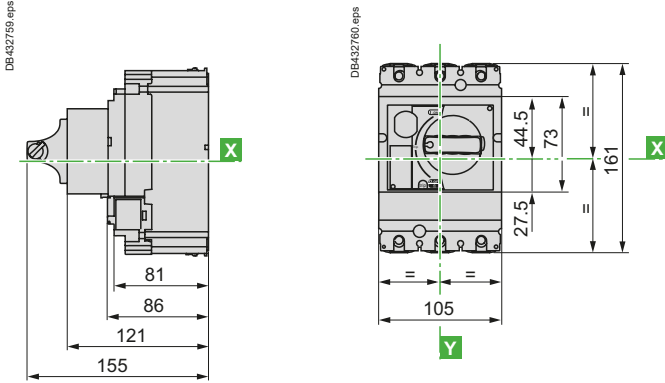

#### GV6P

##### Dimensions

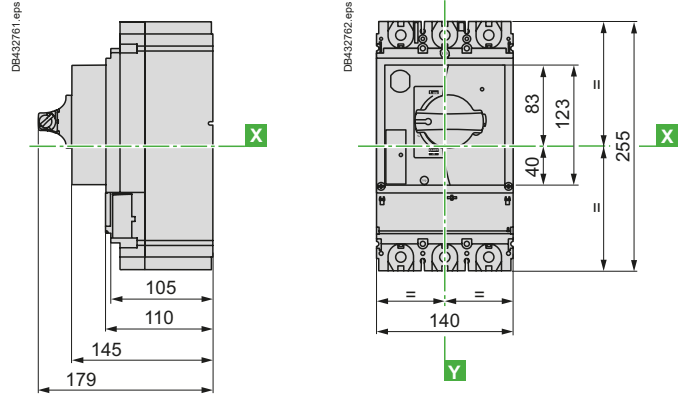

#### With long terminal shields or interphases barriers GV5P + GV7AC04/GV7AC01

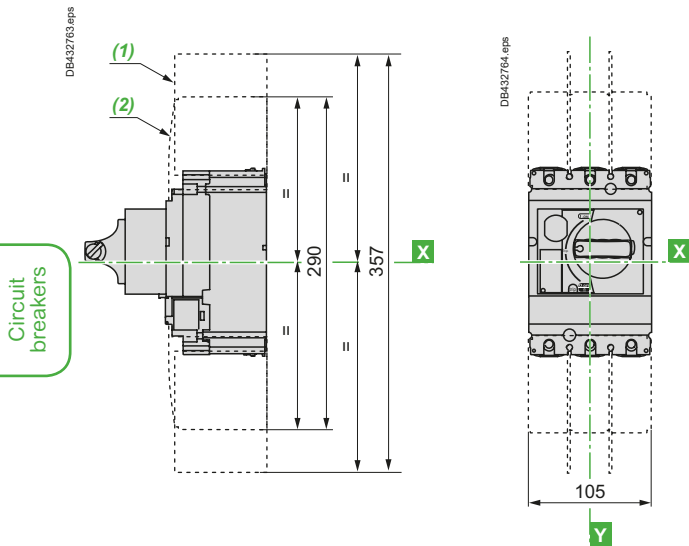

- (1) Interphases barriers: **GV7AC04**.
- (2) Terminal shield: **GV7AC01**.

#### GV6P + LV432593 / LV432595 / LV432570

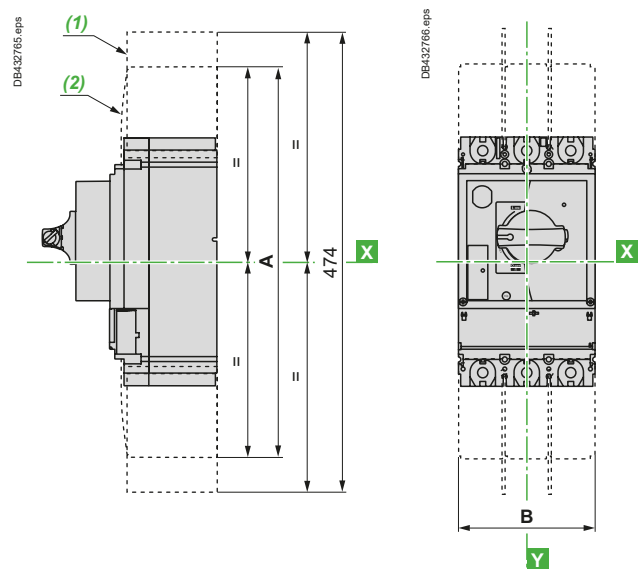

- (1) Interphases barriers: **LV432570**.
- (2) Terminal shield: **LV432593** (45mm) / **LV432595** (52.5mm).

	A	B
<b>LV432593</b>	400	140
<b>LV432595</b>	480	157.5

#### Insulating screen

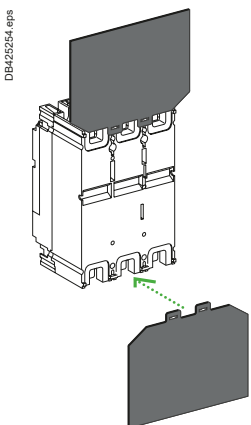

Motor circuit breaker	GV5P + GV7AC05	GV6P + LV432578
3P W x H x thickness (mm)	140 x 105 x 1	203 x 175 x 1.5

# Dimensions, mounting - TeSys GV5 and GV6 - 55 to 250 kW

## TeSys protection components

### Thermal-magnetic motor circuit breakers GV5P and GV6P

#### GV5P/GV6P

##### Panel mounting GV5

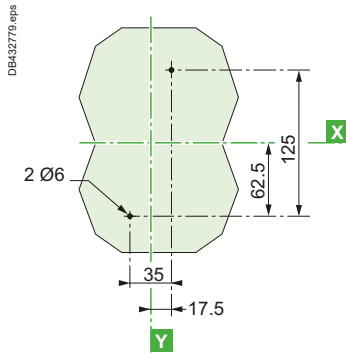

##### Panel mounting GV6

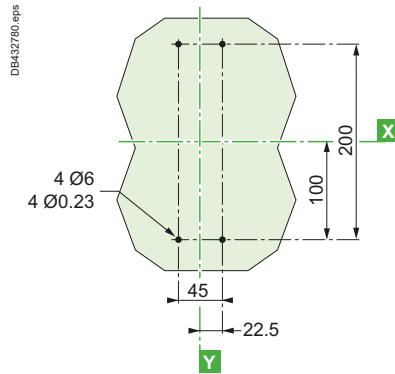

##### Mounting on 2 mounting rails for GV5 only

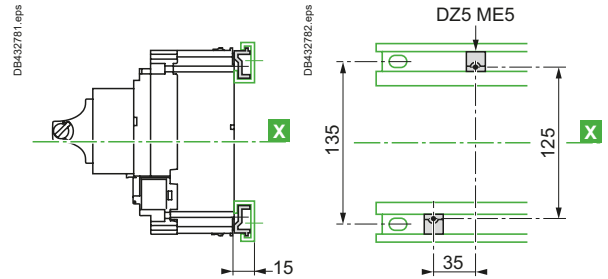

##### Door cut-out mounting GV5P

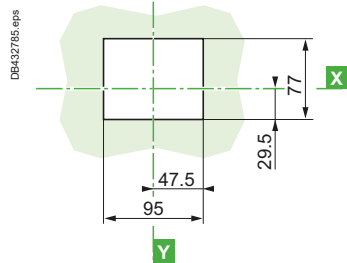
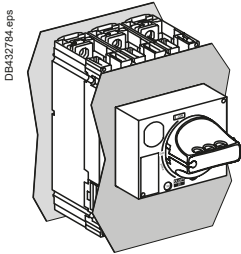

##### With access to trip unit

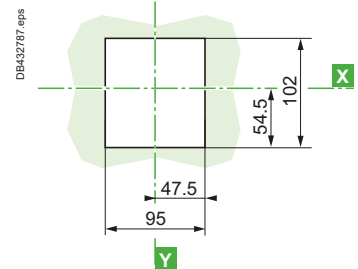
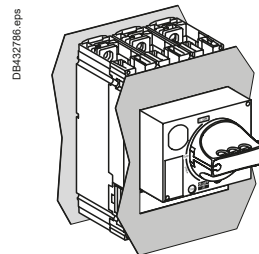

##### Door cut-out mounting GV6P

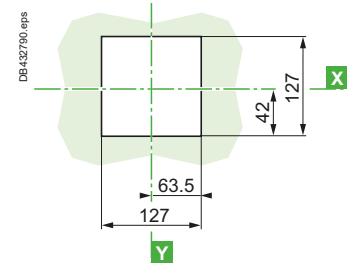
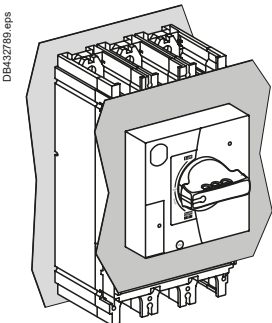

##### With access to trip unit

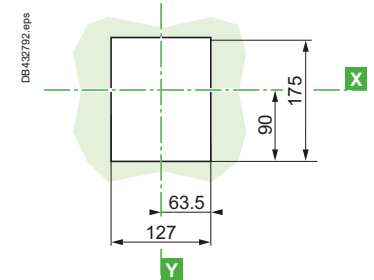
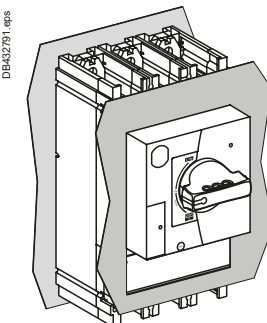

Circuit breakers

TeSys protection components

Thermal-magnetic motor circuit breakers GV5P and GV6P

**GV5P**

**Minimum electrical clearance**

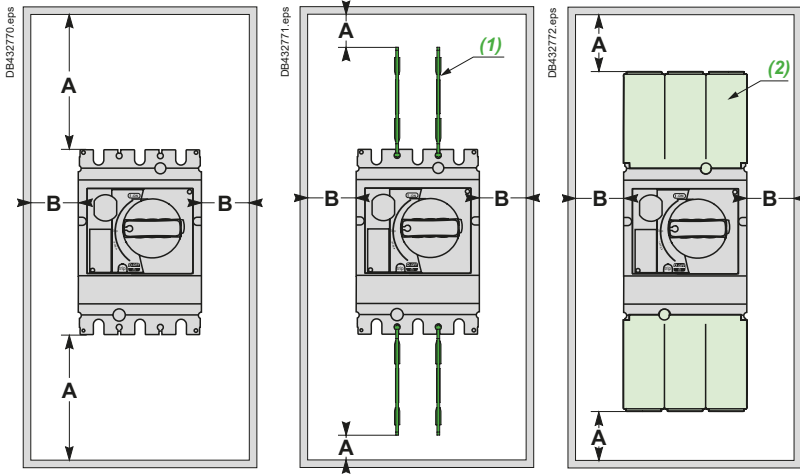

**Clearance in mm**

		Painted sheet metal		Bare metal plate	
		A	B	A	B
No accessories	$V \leq 500 V\sim$	30	0	40	20
	$V > 500 V\sim$	-	-	-	-
Interphases barriers <sup>(1)</sup>	$V \leq 500 V\sim$	0	0	10	20
	$V > 500 V\sim$	-	-	-	-
Terminal shield <sup>(2)</sup>	$V \leq 500 V\sim$	0	0	10	10
	$V > 500 V\sim$	30	10	40	20

**GV6P**

**Minimum electrical clearance**

Circuit breakers

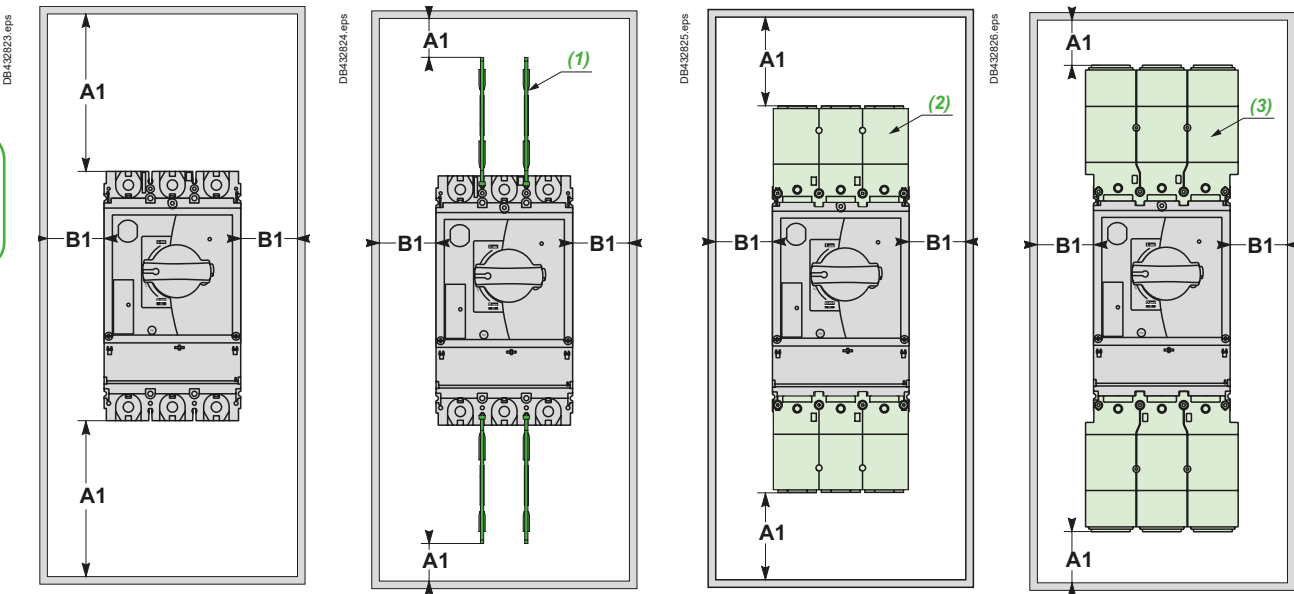

**Clearance in mm**

		Painted sheet metal		Bare sheet metal	
		A1	B1	A1	B1
No accessories	$V \leq 500 V\sim$	30	0	40	20
	$V > 500 V\sim$	-	-	-	-
Interphase barriers <sup>(1)</sup>	$V \leq 500 V\sim$	0	0	10	20
	$V > 500 V\sim$	-	-	-	-
Long terminal shield (LV432593) <sup>(2)</sup>	$V \leq 500 V\sim$	30	0	40	10
	$V > 500 V\sim$	50	0	50	20
Long terminal shield (LV432595) <sup>(3)</sup>	$V \leq 500 V\sim$	0	0	10	10
	$V > 500 V\sim$	30	0	30	20

# Dimensions, mounting - TeSys GV5 and GV6 - 55 to 250 kW

## TeSys protection components

### Thermal-magnetic motor circuit breakers GV5P and GV6P

#### GV5P/GV6P

##### GV5 with extended rotary handle GV7AP01/ GV7AP02

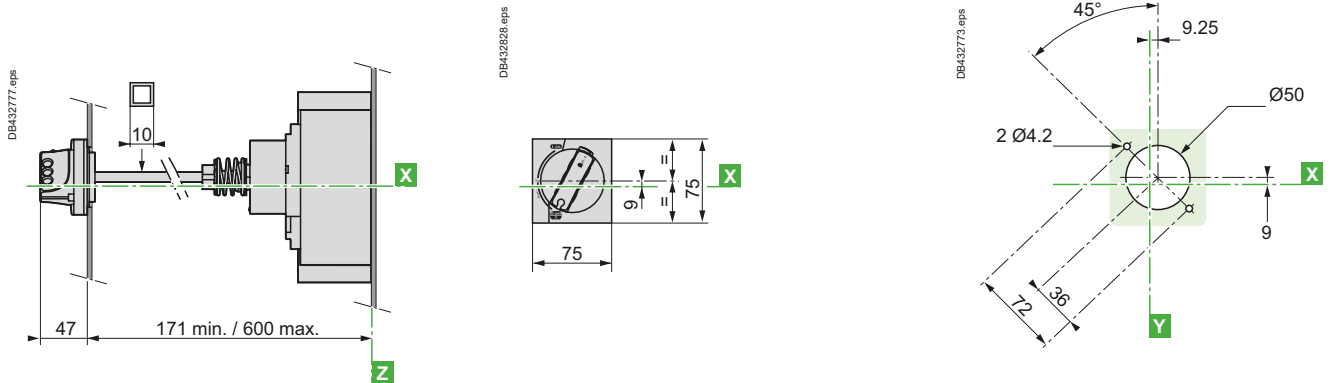

##### GV6 with extended rotary handle LV432598/ LV432600

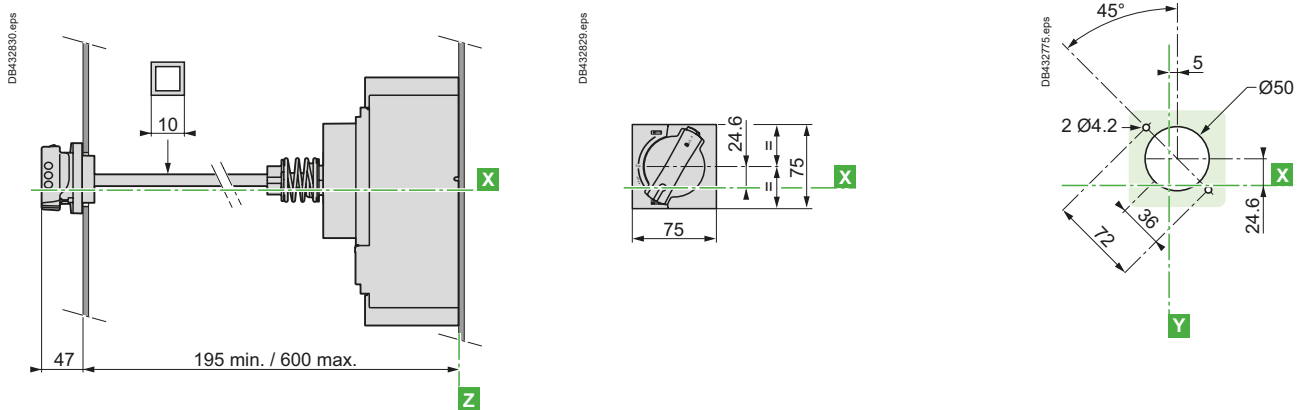

#### GV5P/GV6P

##### MCC type direct rotary handle

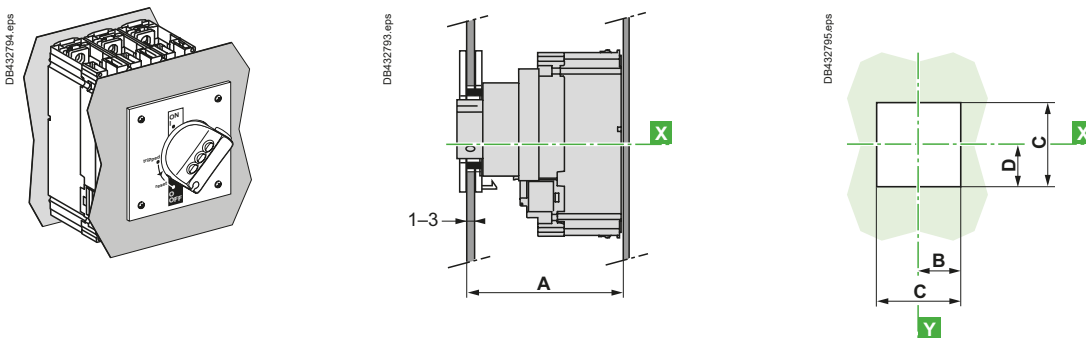

	A	B	C	D
150/220 A	125 ±2	50	100	41
320/500 A	149 ±2	72.5	145	51

## TeSys protection components

Thermal-magnetic motor circuit breakers GV5P and GV6P

### GV5P

Combination of GV5P and TeSys contactor LC1 F●●/LC1 D●● with kit GV7AC0●

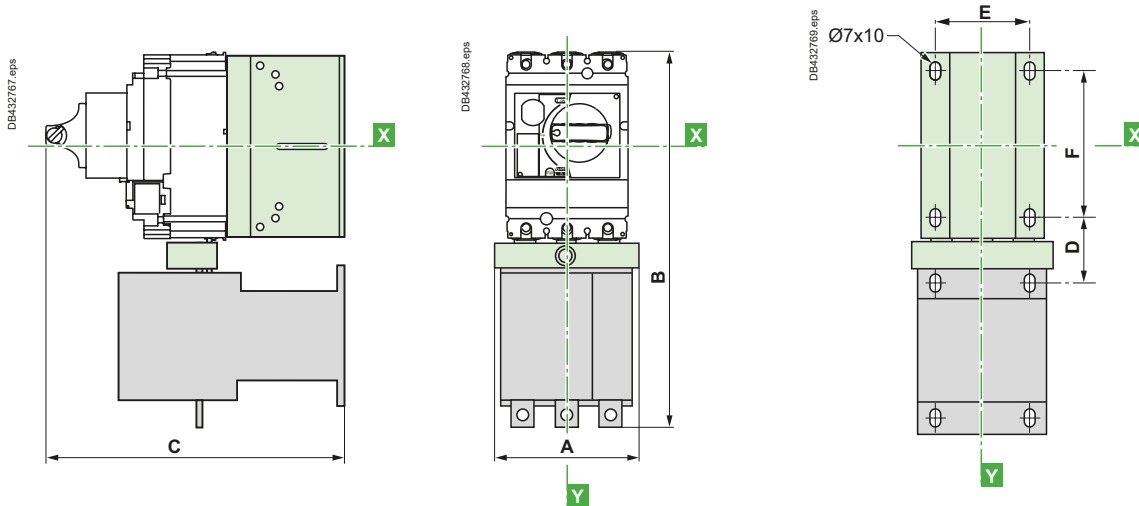

	A	B	C	D	E	F
GV5P + LC1F115 + GV7AC06	119	334	243	44	85	120
GV5P + LC1F150 + GV7AC06	119	334	243	46	85	120
GV5P + LC1F185 + GV7AC06	119	338	249	48	85	120
GV5P + LC1F225 + GV7AC07	131	358	249	57	85	120
GV5P + LC1F265 + GV7AC07	131	364	277	60	85	120
GV5P + LC1D115 + GV7AC08	120	332	205	48	85	120
GV5P + LC1D150 + GV7AC08	120	332	205	48	85	120

Minimum distance between 2 circuit breakers mounted side by side = 0

Circuit breakers

# Dimensions and connection - TeSys GV5 and GV6 - 55 to 250 kW

## TeSys protection components

### Thermal-magnetic motor circuit breakers GV5P and GV6P

#### GV5P/GV6P

##### Front connection without accessories

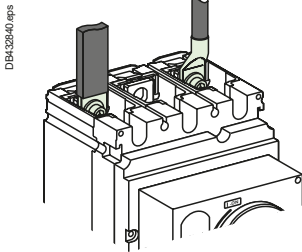

##### GV5

##### Cables with lugs bars

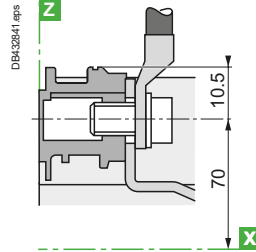

##### GV6

##### Bars/cables with lugs

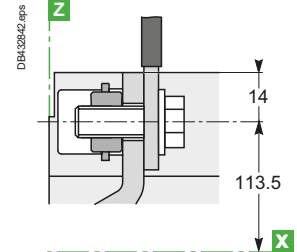

#### GV5P

##### Bare-cables connectors

##### GV7AC021/LV429227/GV7AV022

##### LV429244

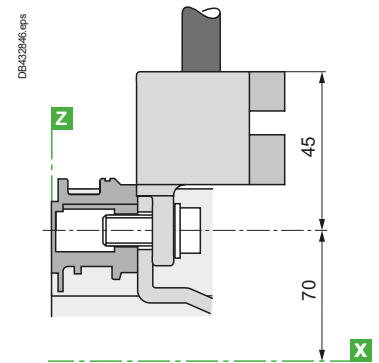
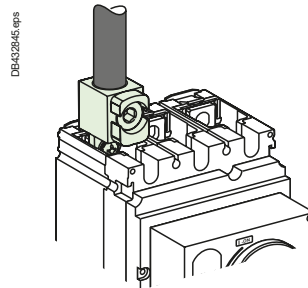
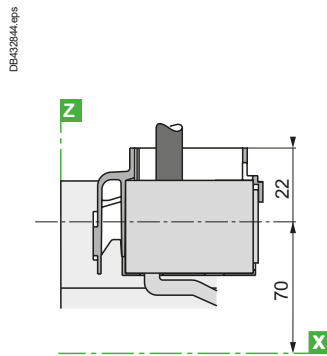
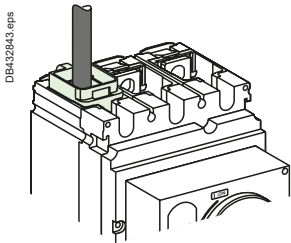

#### GV6P

##### Bare-cables connectors

##### LV432479

##### LV432481

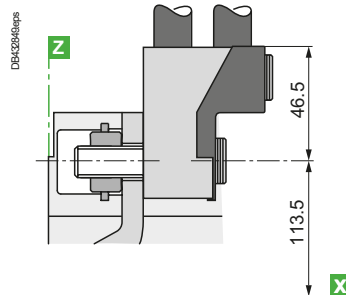
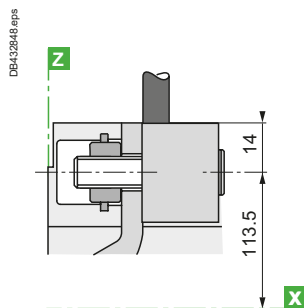
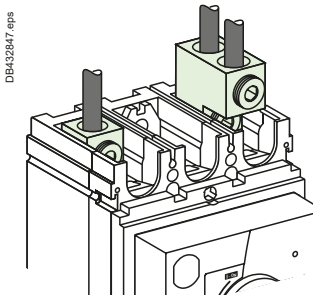

#### GV5P/GV6P

##### Spreaders

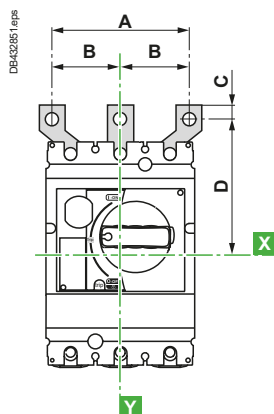
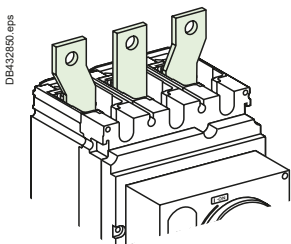

Type	A	B	C	D
GV5P/ Spreaders GV7AC03	114	45	11	100
GV6P/ Spreaders LV432490	135	52.5	15	152.5
GV6P/ Spreaders LV432492	170	70	15	166

Circuit breakers

# Schemes - TeSys GV5 and GV6 - 55 to 250 kW

## TeSys protection components

### Thermal-magnetic motor circuit breakers GV5P and GV6P

#### Schemes

##### Motor circuit breakers

###### GV5P/ 6P

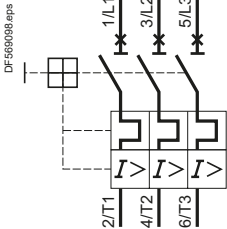

##### Add-on auxiliary contacts according to their location <sup>(1)</sup>

###### GV7 AE11, GV7 AB11

Location 1  
C/O contact



Location 2  
Trip indication



Location 3  
Electrical fault  
indication <sup>(2)</sup>



Location 4  
C/O contact



A self-adhesive label, supplied with the contact, can be affixed to the front face of the circuit-breaker to allow personalised marking according to the function of the contact or contacts.

<sup>(1)</sup> See page B6/52 to B6/54.

<sup>(2)</sup> Adapter LV429451 is mandatory for electrical trip indication in GV5.

##### Electric trips

###### GV7AU●●●

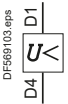

###### GV7AS●●●



##### Thermal fault module LV429424

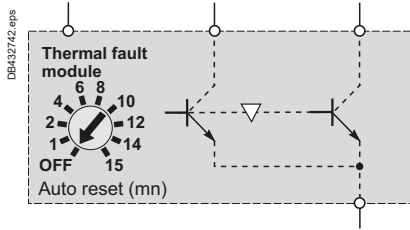

##### Recommended application schemes for LV429424

Circuit breakers

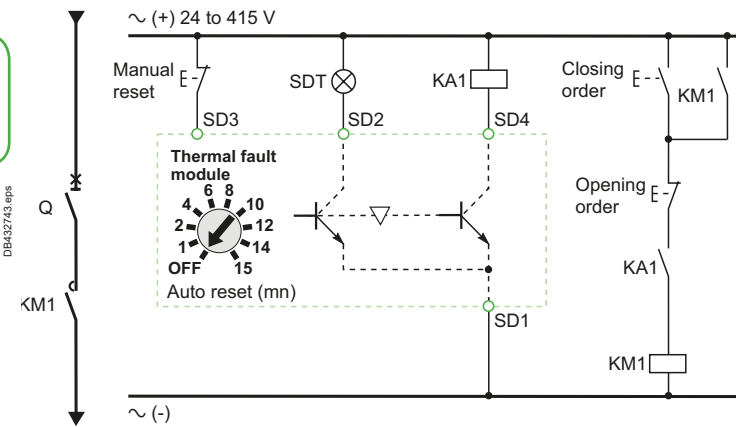

- SD1, SD3:** thermal fault module input power supply
  - SD2:** over-load fault signal output. This output will stay-put until reset
  - SD4:** contactor control output
  - SD2 and SD4:** Static outputs: 24 to 415 V AC / V DC; 80 mA max
  - KM1:** LC1 D or LC1 F contactor
  - KA1:** CA2 or CAD type control relays
- Terminals shown in green ● must be connected by customer.



# TeSys GB2

0.5 to 20 A

(for equipment and control circuits)



# Protection components

Thermal-magnetic circuit breakers TeSys GB2 for the protection of industrial equipment control circuits

Environment			GB2CB	GB2CD	GB2DB	GB2CS
<b>Circuit breaker type</b>			IEC 60947-1, 947-2, EN 60947-1, 60947-2			
Conforming to standards			IEC 60947-1, 947-2, EN 60947-1, 60947-2			
Product certifications			CSA, NEMKO, UL	NEMKO, UL	-	-
Degree of protection	Conforming to IEC 60529		IP 20			
Shock resistance	Conforming to IEC 60068-2-27		22 gn for 20 ms			
Vibration resistance	Conforming to IEC 60068-2-6		5 gn (5...110 Hz)			
Ambient air temperature around the device	Storage	°C	-40...+80			
	Operation	°C	-20...+60			
Flame resistance	Conforming to IEC 60695-2-11	°C	960			
Maximum operating altitude		m	3000			
Operating position	In relation to normal vertical mounting plane					
Cabling	Solid cable	mm <sup>2</sup>	Minimum c.s.a.		Maximum c.s.a.	
	Flexible cable with cable end	mm <sup>2</sup>	1 x 0.75		1 x 6 or 2 x 4	
Tightening torque		N.m	1 x 0.75		1 x 4 or 2 x 2.5	
			1.2			

Technical characteristics			GB2CB		GB2CD		GB2DB		GB2CS		
Utilisation category	Conforming to IEC 60947-2		A		A		A		A		
Rated operational voltage (Ue)	Conforming to IEC 60947-2	V	250 <sup>(1)</sup>		250		415		250 <sup>(1)</sup>		
	Conforming to CSA C22-2 Nr 14 and UL 1077	V	277		-		277		-		
Rated operational frequency	Conforming to IEC 60947-2	Hz	50/60		50/60		50/60		50/60		
Rated impulse withstand voltage (U imp)	Conforming to IEC 60947-2	kV	4		4		4		4		
Total power dissipated per pole		W	2		2		2		1.9		
Mechanical and electrical durability	C.O.: Closing - Opening	C.O.	8000		8000		8000		8000		
Operational current correction coefficient (a or --)	According to the permissible ambient temperature	°C	-20	-10	0	+10	+20	+30	+40	+50	+60
	Correction coefficient		1.2	1.15	1.1	1.05	1	0.95	0.90	0.85	0.80
Tripping threshold	Of the magnetic trips		12...16 In		12...16 In		12...16 In		5...7 In		

(1) Ue = 415 V when a GB2 circuit breaker is fitted on every live conductor.

Circuit breakers

## Tripping curves

Average operating time at 20 °C without prior current flow (cold state)

GB2CB, GB2 CD, GB2 DB

GB2CS

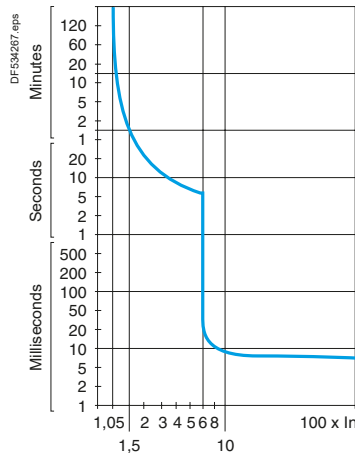
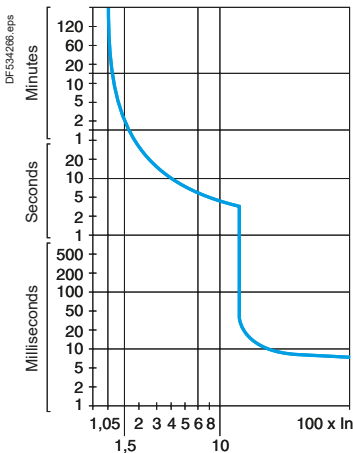

## Protection components

Thermal-magnetic circuit breakers TeSys GB2 for the protection of industrial equipment control circuits

Circuit breaker type			GB2												
			CB05	CB06	CB07	CB08	CB09	CB10	CB12	CB14	CB16	CB20	CB21	CB22	
Rating		A	0.5	1	2	3	4	5	6	8	10	12	16	20	
Breaking capacity conforming to IEC 60947-2 ~ 50/60 Hz	110 V	Icu	kA	50	50	15	10	6	3	3	2	2	2	2	
		Ics % <sup>(1)</sup>		100	50	50	50	50	75	75	75	75	75	75	75
	230/240 V	Icu	kA	50	50	15	3	3	2	1.5	1.5	1.5	1.5	1.5	
		Ics % <sup>(1)</sup>		25	25	25	50	50	75	75	75	75	75	75	75
Associated fuses, if required if Isc > breaking capacity Icu conforming to IEC 60947-2	110 V	aM	A	*	*	20	25	25	40	40	50	50	63	63	
		gG	A	*	*	25	32	32	50	50	63	63	80	80	
	230/240 V	aM	A	*	*	16	20	20	32	32	40	40	50	50	
		gG	A	*	*	25	32	32	40	40	50	50	63	63	

Circuit breaker type			GB2												
			CD05	CD06	CD07	CD08	CD09	CD10	CD12	CD14	CD16	CD20	CD21	CD22	
Rating		A	0.5	1	2	3	4	5	6	8	10	12	16	20	
Breaking capacity conforming to IEC 60947-2 ~ 50/60 Hz	110 V	Icu	kA	50	50	15	10	6	3	3	2	2	2	2	
		Ics % <sup>(1)</sup>		100	50	50	50	50	75	75	75	75	75	75	75
	230/240 V	Icu	kA	50	50	15	3	3	2	1.5	1.5	1.5	1.5	1.5	
		Ics % <sup>(1)</sup>		25	25	25	50	50	75	75	75	75	75	75	75
Associated fuses, if required if Isc > breaking capacity Icu conforming to IEC 60947-2	110 V	aM	A	*	*	20	25	25	40	40	50	50	63	63	
		gG	A	*	*	25	32	32	50	50	63	63	80	80	
	230/240 V	aM	A	*	*	16	20	20	32	32	40	40	50	50	
		gG	A	*	*	25	32	32	40	40	50	50	63	63	

Circuit breaker type			GB2												
			DB05	DB06	DB07	DB08	DB09	DB10	DB12	DB14	DB16	DB20	DB21	DB22	
Rating		A	0.5	1	2	3	4	5	6	8	10	12	16	20	
Breaking capacity conforming to IEC 60947-2 ~ 50/60 Hz	110 V	Icu	kA	50	50	15	10	6	3	3	2	2	2	2	
		Ics % <sup>(1)</sup>		100	50	50	50	50	75	75	75	75	75	75	75
	230/240 V	Icu	kA	50	50	15	3	3	2	1.5	1.5	1.5	1.5	1.5	
		Ics % <sup>(1)</sup>		25	25	25	50	50	75	75	75	75	75	75	75
	400/415 V	Icu	kA	50	50	15	3	3	2	1.5	1.5	1.5	1.5	1.5	
		Ics % <sup>(1)</sup>		25	25	25	50	50	75	75	75	75	75	75	75
Associated fuses, if required if Isc > breaking capacity Icu conforming to IEC 60947-2	110 V	aM	A	*	*	20	25	25	40	40	50	50	63	63	
		gG	A	*	*	25	32	32	50	50	63	63	80	80	
	230/240 V	aM	A	*	*	16	20	20	32	32	40	40	50	50	
		gG	A	*	*	25	32	32	40	40	50	50	63	63	
	400/415 V	aM	A	*	*	16	20	20	32	32	40	40	50	50	
		gG	A	*	*	25	32	32	40	40	50	50	63	63	

<sup>(1)</sup> As % of Icu.

\* Fuse not required. Breaking capacity Icu > Isc.

Circuit breakers

# Characteristics - TeSys GB

## Protection components

Thermal-magnetic circuit breakers TeSys GB2 for the protection of industrial equipment control circuits

Circuit breaker type				GB2																	
				●●05	●●06	●●07	●●08	●●09	●●10	●●12	●●14	●●16	●●20	●●21	●●22						
Breaking capacity (Icu) conforming to IEC 60947-2 ---	24 V	kA		1.5	1.5	1.5	1.5	1.5	1.5	1.5	1.5	1.5	1.5	1.5	1.5						
	48 V	kA		1	1	1	1	1	1	1	1	–	–	–	–						
Operational current conforming to IEC 60947-5-1 ---	DC-12	24 V	A	0.5	1	2	3	4	5	6	8	10	12	16	20						
		48 V	A	0.5	1	2	3	4	5	6	8	10	12	16	20						
	DC-13	24 V	A	0.5	1	2	3	4	5	6	8	10	12	16	20						
		48 V	A	0.5	1	2	3	4	5	6	8	–	–	–	–						
Circuit breaker type				GB2																	
				CS05						CS06											
Rating		A		0.5						1											
Breaking capacity conforming to IEC 60947-2 ~ 50/60 Hz	110 V	Icu	kA	50						50											
		Ics % <sup>(1)</sup>		100						100											
	230/240 V	Icu	kA	50						50											
Ics % <sup>(1)</sup>			25						25												
400/415 V <sup>(2)</sup>	Icu	kA	50						50												
	Ics % <sup>(1)</sup>		25						25												
Breaking capacity (Icu) conforming to IEC 60947-2 ---	24 V	kA		1.5						1.5											
	48 V	kA		1						1											
Operational current conforming to IEC 60947-5-1 ---	DC-12	24 V	A	0.5						1											
		48 V	A	0.5						1											
	DC-13	24 V	A	0.5						1											
		48 V	A	0.5						1											
Maximum permissible line length for star-delta starting (length of cable containing 2 or more conductors)	With contactors LC●D09...D18	Operational voltage	V	48			110			230			48			110			230		
		C.s.a.		0.60 mm <sup>2</sup>	m	<sup>(3)</sup>		31		365		6		85		230					
			0.75 mm <sup>2</sup>	m	<sup>(3)</sup>		39		460		8		110		290						
			1 mm <sup>2</sup>	m	<sup>(3)</sup>		52		610		10		145		380						
			1.5 mm <sup>2</sup>	m	<sup>(3)</sup>		78		910		15		220		570						
			2.5 mm <sup>2</sup>	m	<sup>(3)</sup>		130		1520		26		360		950						
			4 mm <sup>2</sup>	m	<sup>(3)</sup>		200		2400		41		580		1500						
	With contactors LC●D25...D32	Operational voltage	V	48			110			230			48			110			230		
		C.s.a.		0.60 mm <sup>2</sup>	m	<sup>(3)</sup>		<sup>(3)</sup>		230		<sup>(3)</sup>		56		230					
				0.75 mm <sup>2</sup>	m	<sup>(3)</sup>		<sup>(3)</sup>		290		<sup>(3)</sup>		70		290					
				1 mm <sup>2</sup>	m	<sup>(3)</sup>		<sup>(3)</sup>		390		<sup>(3)</sup>		95		380					
				1.5 mm <sup>2</sup>	m	<sup>(3)</sup>		<sup>(3)</sup>		580		<sup>(3)</sup>		140		570					
				2.5 mm <sup>2</sup>	m	<sup>(3)</sup>		<sup>(3)</sup>		970		<sup>(3)</sup>		230		950					
				4 mm <sup>2</sup>	m	<sup>(3)</sup>		<sup>(3)</sup>		1500		<sup>(3)</sup>		375		1500					
		With contactors LC●D40...D80	Operational voltage	V	48			110			230			48			110			230	
	C.s.a.			0.60 mm <sup>2</sup>	m	<sup>(3)</sup>		<sup>(3)</sup>		46		<sup>(3)</sup>		13		100					
				0.75 mm <sup>2</sup>	m	<sup>(3)</sup>		<sup>(3)</sup>		60		<sup>(3)</sup>		17		130					
				1 mm <sup>2</sup>	m	<sup>(3)</sup>		<sup>(3)</sup>		80		<sup>(3)</sup>		22		170					
				1.5 mm <sup>2</sup>	m	<sup>(3)</sup>		<sup>(3)</sup>		120		<sup>(3)</sup>		34		250					
				2.5 mm <sup>2</sup>	m	<sup>(3)</sup>		<sup>(3)</sup>		190		<sup>(3)</sup>		56		420					
			4 mm <sup>2</sup>	m	<sup>(3)</sup>		<sup>(3)</sup>		310		<sup>(3)</sup>		90		680						

(1) As % of Icu.  
 (2) One GB2CS circuit breaker on each live conductor.  
 (3) Use relays.

Circuit breakers

# Dimensions, schemes - TeSys GB

## Protection components

Thermal-magnetic circuit breakers TeSys GB2 for the protection of industrial equipment control circuits

### Dimensions

#### GB2CB●●, GB2CD●●, GB2CS●●

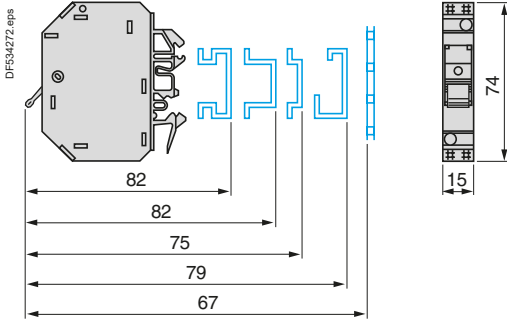

#### GB2DB●●

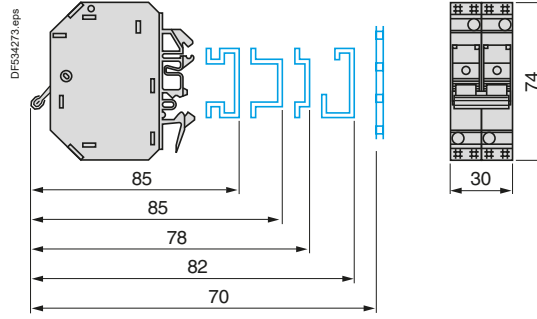

Marking: up to twelve AB1 R clip-in markers.

### Schemes

#### GB2CB●●

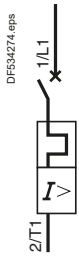

#### GB2CD●●

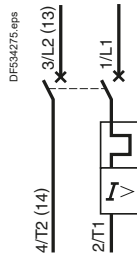

#### GB2DB●●

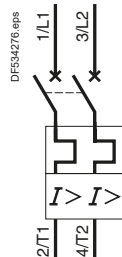

#### GB2CS●●



Circuit breakers

