

Terminal Blocks

NEMA Type Terminal Blocks

Catalog

9080CT9601R11/17
Release date 11/2017



SQUARE  TM

by **Schneider** Electric

Legal Information

The Schneider Electric brand and any registered trademarks of Schneider Electric Industries SAS referred to in this guide are the sole property of Schneider Electric SA and its subsidiaries. They may not be used for any purpose without the owner's permission, given in writing. This guide and its content are protected, within the meaning of the French intellectual property code (Code de la propriété intellectuelle français, referred to hereafter as "the Code"), under the laws of copyright covering texts, drawings and models, as well as by trademark law. You agree not to reproduce, other than for your own personal, noncommercial use as defined in the Code, all or part of this guide on any medium whatsoever without Schneider Electric's permission, given in writing. You also agree not to establish any hypertext links to this guide or its content. Schneider Electric does not grant any right or license for the personal and noncommercial use of the guide or its content, except for a non-exclusive license to consult it on an "as is" basis, at your own risk. All other rights are reserved.

Electrical equipment should be installed, operated, serviced, and maintained only by qualified personnel. No responsibility is assumed by Schneider Electric for any consequences arising out of the use of this material.



As standards, specifications, and designs change from time to time, please ask for confirmation of the information given in this publication.

Schneider Electric, Fingersafe, Linergy, and Square D are trademarks and the property of Schneider Electric SE, its subsidiaries, and affiliated companies. All other trademarks are the property of their respective owners





Table of Contents

Product Overview.....	5
Quick Selector	6
Box Lug Termination.....	8
Other Terminations	14
Other Blocks	16
Custom Assemblies.....	18
Mounting Track.....	19
Accessories	20
Single-Pole Thermal-Magnetic Control Circuit Protectors	24
Approximate Dimensions.....	26
Type G Block.....	26
Circuit Protectors and Assemblies.....	28
Mounting Track and End Clamps	29

Product Overview

Family	Description
 <p data-bbox="156 470 335 492">Class 9080 Type G</p>	<p data-bbox="662 259 997 282">Square D™ 9080 Terminal Blocks</p> <p data-bbox="662 293 1476 389">This family of NEMA blocks and accessories offers features such as a large variety of colors, high density to save space in applications, multiple mounting methods such as 35 mm DIN rail, 9080GH (3/4") track, or direct panel mounting. They are UL component recognized, CSA approved, RoHS compliant, and CE marked.</p>
	<p data-bbox="662 517 941 539">Square D Circuit Protectors</p> <p data-bbox="662 551 1460 669">The Class 9080 Type GCB Series C thermal-magnetic circuit protector is a trip-free, track-mountable device with current ratings from 0.1–15 A. The thermal feature trips when there is an overload of ten times rated current or less. The magnetic mechanism trips instantaneously when there is a short circuit. Maximum interrupt rating of 200 A, but not exceeding 10,000% (100 times) rated current.</p>

NOTE: The product lines listed below are not shown in this catalog. Please refer to the referenced catalog included with each family.



Family	Description
	<p data-bbox="662 896 1324 918">Schneider Electric™ NSYEB Enclosed Power Distribution Blocks</p> <p data-bbox="662 929 1460 1142">NSYEB power distribution blocks are enclosed IEC versions of our NEMA 9080 power distribution blocks, which are finger safe from the front according to IP20, and available with copper or aluminum lugs. They have Short-Circuit Current Ratings (SCCR) up to 100 kA. They are one-pole modular units with an interlocking dovetail feature that enables ganging of the blocks to create multi-pole configurations according to application requirements. Most are UL Listed (some are UL component recognized), CSA approved, and RoHS compliant. CE marking ensures acceptance throughout the European community. The UL Listed blocks meet feeder circuit spacing requirements.</p> <p data-bbox="662 1153 941 1176">Refer to catalog 9080CT9603</p>
 <p data-bbox="156 1404 343 1426">Class 9080 Type LB</p>	<p data-bbox="662 1200 1141 1223">Square D 9080 Open Power Distribution Blocks</p> <p data-bbox="662 1234 1452 1352">Available in a wide variety of sizes, these NEMA open power distribution blocks are available in one, two, and three pole versions with either aluminum or copper lugs. Many blocks have been tested to achieve SCCR up to 100 kA. They are UL component recognized, CSA approved, RoHS compliant, and CE marked. A selection of covers completes this family.</p> <p data-bbox="662 1364 941 1386">Refer to catalog 9080CT9603</p>
 <p data-bbox="156 1673 343 1695">Class 9080 Type FB</p>	<p data-bbox="662 1451 981 1473">Square D 9080 FB Fuse Holders</p> <p data-bbox="662 1485 1460 1581">This family of NEMA fuse holders will accept types H, R, CC, M, and J fuses up to 200 amperes. Both 250 V and 600 V versions are available. Types H, R, J, and CC are UL Listed. Type M fuse holders are UL component recognized. They are all CSA approved, CE marked, and RoHS compliant.</p> <p data-bbox="662 1592 941 1615">Refer to catalog 9080CT9603</p>
 <p data-bbox="156 2013 367 2036">Linerly Terminal Block</p>	<p data-bbox="662 1720 1125 1742">Schneider Electric Linergy™ Terminal Blocks</p> <p data-bbox="662 1753 1388 1776">Depending on the application, there are several types of IEC terminal blocks:</p> <ul data-bbox="678 1787 1460 2004" style="list-style-type: none"> • Screw technology terminal blocks are suitable for the majority of connection applications due to their wide range of functions and connection possibilities. • Spring technology requires no maintenance and helps provide a separation of mechanical and electrical functions. • Push-in terminal blocks reduce wiring time and eliminate the need for regular re-tightening. • The hybrid offer is a combination of screw terminal and Insulation Displacement Connection (IDC). <p data-bbox="662 2016 1460 2067">These blocks are UL component recognized, CSA approved, CE marked, and RoHS compliant.</p> <p data-bbox="662 2078 941 2101">Refer to catalog 9080CT1301.</p>

Quick Selector

All Square D terminal blocks are:



- 600 V rated (except the 9080 GT6 transient voltage suppressor, which is 120 V)
- Track mountable (9080GK6 can also be directly mounted).

Table 1 - Box Lug Termination

Termination		Box Lug						
Block Material		Nylon						
Wire Range		#10-#22	#8-#22	#8-#22	#10-#22	#4-#18	1/0-#12	250 kcmil-#6
Maximum Amperage ¹	UL	30	60	60	70	110	180	255
	CSA	30	60	60	40	85	170	280
Sections per foot		51	34	34	34	28	17	10
Temperature Rating		-40 to 257 °F (-40 to 125 °C)						
Flammability Rating		UL94V2						
Listings			File E60616, Guide XCFR2			File LR62144, Class 6228 01		RoHS Compliant
Catalog Number		GM6	GR6	GR6T	GK6	GC6	GD6	GE6
Page		7	7	7	9	9	9	11



1. These maximum current values assume the use of insulated copper conductors with 75° C temperature rating, and are calculated based on NEC Article 310, Table 310-16. In most cases this value is the maximum ampacity of that wire or combination of wires (as listed in the above table) which has the greatest current carrying capacity. The actual allowable current for a particular application is dependent upon the number, size, insulation class and other characteristics of the wires used.

Table 2 - Other Terminations



Termination		Flat Screw	Pressure Wire	Slip-On	Fuse Block	Circuit Isolating Switch	Transient Voltage Suppressor
Block Material		Nylon					
Wire Range		#12-#22	#12-#18	#12-#22	#10-#18	#10-#18	#10-#18
Maximum Amperage	UL	40	40	20	30	30	N/A
	CSA	40	40	20	30	30	N/A
Sections per foot		32	32	16	16	16	24
Temperature Rating		-40 to 257 °F (-40 to 125 °C)					
Flammability Rating		UL94V2					
Listings			File E60616, Guide XCFR2			File LR62144, Class 6228 01	
Catalog Number		GA6	GP6	GS6	GF6	GG6	GT6
Page		13	13	13	15	15	15

Box Lug Termination

Table 3 - Types GM6, GR6, and GR6T (continued on next page)





Class 9080		TYPE GM6	TYPE GR6	TYPE GR6T
		 High Density Block	 Without Test Probe Adapter	 With Test Probe Adapter
Maximum Voltage Rating		600	600	600
Maximum Amperage Rating ²	UL	30	60	60
	CSA	30	60	60
Wire Range		#22-#10 AWG	#22-#8 AWG	#22-#8 AWG
Maximum Wire Combination		1 - #10, 1 or 2 - #18 1 - #12, 1 to 5 - #20 1 - #14, 1 to 8 - #22 1 or 2 - #16	1 - #8, 1 to 4 - #16 1 - #10, 1 to 5 - #18 1 to 3 - #12, 1 to 8 - #20 1 to 4 - #14, 1 to 10 - #22	1 - #8, 1 to 4 - #16 1 - #10, 1 to 5 - #18 1 to 3 - #12, 1 to 8 - #20 1 to 4 - #14, 1 to 10 - #22
Wire Type		Solid or Stranded Copper Wire	Solid or Stranded Copper Wire	Solid or Stranded Copper Wire
Density—Sections per foot		51	34	34
Approx. Dimensions: D x H x W		1.72 x 1.82 x .235 in. (44 x 46 x 6 mm)	1.72 x 1.82 x .35 in. (44 x 46 x 9 mm)	1.72 x 1.82 x .35 in. (44 x 46 x 9 mm)
Block Material		Nylon		
Busbar Material		Tin Plated Brass	N/A	N/A
Screw Material		Steel with Zinc Plating and Chromate Film		
Box Lug Material		Zinc Plated Steel	Copper	
Temperature Rating		-40 to 257° F (-40 to 125° C)	-40 to 257° F (-40 to 125° C)	-40 to 257° F (-40 to 125° C)
Flammability Rating		UL94V2	UL94V2	UL94V2
Recommended Tightening Torque		7-8 lbf-in (0.8-0.9 N•m)	18-20 lbf-in (2.1-2.3 N•m)	18-20 lbf-in (2.1-2.3 N•m)
Listings	UL	File E60616, Guide XCFR2		
	CSA	File LR62144, Class 6228 01		
RoHS Compliant				
Fingersafe™ per DIN 57470		YES	YES	YES
Block:				
• Natural (White)		GM6	GR6	GR6T
• Black		GMB6	GRB6	—
• Blue		GML6	GRL6	—
• Green		GMG6	GRG6	—
• Grey		GME6	GRE6	—
• Orange		GMS6	GRS6	—
• Red		GMR6	GRR6	—
• Yellow		GMY6	GRY6	—

2. These maximum current values assume the use of insulated copper conductors with 75° C temperature rating, and are calculated based on NEC Article 310, Table 310-16. In most cases this value is the maximum ampacity of that wire or combination of wires (as listed in the above table) which has the greatest current carrying capacity. The actual allowable current for a particular application is dependent upon the number, size, insulation class and other characteristics of the wires used.



Class 9080	TYPE GM6	TYPE GR6	TYPE GR6T
	 High Density Block	 Without Test Probe Adapter	 With Test Probe Adapter
End Barrier	GM6B	GM6B	GM6B
Mounting Track: ³			
• DIN 3: 0.5 m long	MH320	MH320	MH320
• DIN 3: 1.0 m long	MH339	MH339	MH339
• DIN 3: 2.0 m long	MH379	MH379	MH379
• Standard: 3 ft long	GH136	GH136	GH136
• Snap-Off: 3 ft long	GH236	GH236	GH236
• High Rise: 3 ft long	GH336	GH336	GH336
End Clamps:			
• Screw-in	GH10	GH10	GH10
• Slip-in	GH11	GH11	GH11
• DIN 3 End Clamp	MHA10	MHA10	MHA10
Jumpers:			
• 2 pole	GH700	GH72	GH72
• 6 pole	GH710	GH73	GH73
Fanning Strip	—	GH52	GH52
Cover	—	GH62	GH62
Vinyl Marking Strip	GH220	GH220	GH220
Sheets of Blank Marking Tabs	—	GH200	GH200
Sheets of Marked Tabs	—	GH210	GH210
Marking Strip End Plug	GH60	GH60	GH60

3. For additional mounting track, see page 18.

Table 4 - Types GK6, GC6, and GD6 (continued on next page)



Class 9080		TYPE GK6	TYPE GC6	TYPE GD6
		 Mounts on Channel or Directly to a Panel		
Maximum Voltage Rating		600	600	600
Maximum Amperage Rating ⁴	UL	70	110	180
	CSA	40	85	170
Wire Range		#22-#10 AWG	#18-#4 AWG	#12-#1/0 AWG
Maximum Wire Combination		1 - #10, 1 or 5 - #18 1 or 2 - #12, 1 to 8 - #20 1 or 2 - #14, 1 to 10 - #22 1 to 4 - #16	1 - #4, 1 or 5 - #12 1 - #6, 1 or 6 - #14 1 or 2 - #8, 1 to 6 - #16 1 to 4 - #10, 1 to 8 - #18	1 - #10, 1 to 3 - #6 1 - #1, 1 to 5 - #8 1 - #2, 1 to 6 - #10 1 or 2 - #4, 1 to 7 - #12
Wire Type		Solid or Stranded Copper Wire	Solid or Stranded Copper Wire	Solid or Stranded Copper Wire
Density—Sections per foot		35	28	17
Approx. Dimensions: D x H x W		1.40 x 1.39 x .35 in. (36 x 35 x 9 mm)	1.99 x 2.13 x .43 in. (50 x 54 x 11 mm)	2.12 x 2.71 x .70 in. (54 x 69 x 18 mm)
Block Material		Nylon		
Busbar Material		N/A	Tin Plated Brass	Tin Plated Copper
Screw Material		Steel with Zinc Plating and Chromate Film		
Box Lug Material		Copper	Zinc Plated Steel	Tin Plated Steel
Temperature Rating		-40 to 257° F (-40 to 125° C)	-40 to 257° F (-40 to 125° C)	-40 to 257° F (-40 to 125° C)
Flammability Rating		UL94V2	UL94V2	UL94V2
Recommended Tightening Torque		11-12 lbf-in (1.2-1.4 N•m)	32-35 lbf-in (3.6-4.0 N•m)	45-50 lbf-in (5.0-5.6 N•m)
Listings	 	File E60616, Guide XCFR2		
RoHS Compliant		File LR62144, Class 6228 01		
Fingersafe per DIN 57470		NO	NO	NO
Block:				
• Natural (White)		GK6	GC6	GD6
• Black		GKB6	—	—
• Blue		GKL6	—	—
• Green		GKG6	—	—
• Grey		GKE6	—	—
• Orange		GKS6	—	—
• Red		GKR6	—	—
• Yellow		GKY6	—	—
End Barrier		GK6B	GC6B	GD6B

4. These maximum current values assume the use of insulated copper conductors with 75° C temperature rating, and are calculated based on NEC Article 310, Table 310-16. In most cases this value is the maximum ampacity of that wire or combination of wires (as listed in the above table) which has the greatest current carrying capacity. The actual allowable current for a particular application is dependent upon the number, size, insulation class and other characteristics of the wires used.

Class 9080	TYPE GK6	TYPE GC6	TYPE GD6
	 <p>Mounts on Channel or Directly to a Panel</p>		
Mounting Track: ⁵			
• DIN 3: 0.5 m long	—	MH320	MH320
• DIN 3: 1.0 m long	—	MH339	MH339
• DIN 3: 2.0 m long	—	MH379	MH379
• Standard: 3 ft long	GH136	GH136	GH136
• Snap-Off: 3 ft long	GH236	GH236	GH236
• High Rise: 3 ft long	GH336	GH336	GH336
End Clamps:			
• Screw-in	GH10	GH10	GH10
• Slip-in	—	GH11	GH11
• DIN 3 End Clamp	—	MHA10	MHA10
Jumpers:			
• 2 pole	GH72	GH74	GH76
• 6 pole	GH73	GH75	GH77
Fanning Strip	GH52	—	—
Cover	—	—	—
Vinyl Marking Strip	GH220	GH220	GH220
Sheets of Blank Marking Tabs	—	—	GH200
Sheets of Marked Tabs	—	—	GH210
Marking Strip End Plug	GH60	GH60	GH60

5. For additional mounting track, see page 18.

Table 5 - Type GE6 (continued on next page)

Class 9080		TYPE GE6
		
Maximum Voltage Rating		600
Maximum Amperage Rating ⁶	UL	255
	CSA	280
Wire Range		#6 AWG–250 kcmil
Maximum Wire Combination		1 - 250 kcmil, 1 - #1/0 1 - #4/0, 1 - #1 1 - #3/0, 1 - #2 1 - #2/0, 1 - #4 or #6
Wire Type		Copper or Aluminum Wire
Density—Sections per foot		10
Approx. Dimensions: D x H x W		3.32 x 2.34 x 1.17 in. (84 x 59 x 30 mm)
Block Material		Nylon
Busbar Material		N/A
Screw Material		Aluminum with Tin Plating
Box Lug Material		Tin Plated Aluminum
Temperature Rating		-40 to 257° F (-40 to 125° C)
Flammability Rating		UL94V2
Recommended Tightening Torque		225–250 lbf-in (25.4–28.2 N•m)
Listings		File E60616, Guide XCFR2
RoHS Compliant		File LR62144, Class 6228 01
Fingersafe per DIN 57470		NO
Block:		
• Natural (White)		GE6
• Black		—
• Blue		—
• Green		—
• Grey		—
• Orange		—
• Red		—
• Yellow		—
End Barrier		—
Mounting Track: ⁷		



6. These maximum current values assume the use of insulated copper conductors with 75° C temperature rating, and are calculated based on NEC Article 310, Table 310-16. In most cases this value is the maximum ampacity of that wire or combination of wires (as listed in the above table) which has the greatest current carrying capacity. The actual allowable current for a particular application is dependent upon the number, size, insulation class and other characteristics of the wires used.

7. For additional mounting track, see page 18.



Class 9080	TYPE GE6
	
• DIN 3: 0.5 m long	MH320
• DIN 3: 1.0 m long	MH339
• DIN 3: 2.0 m long	MH379
• Standard: 3 ft long	GH136
• Snap-Off: 3 ft long	GH236
• High Rise: 3 ft long	GH336
End Clamps:	
• Screw-in	GH10
• Slip-in	—
• DIN 3 End Clamp	MHA10
Jumpers:	
• 2 pole	—
• 6 pole	—
Fanning Strip	—
Cover	—
Vinyl Marking Strip	GH220
Sheets of Blank Marking Tabs	—
Sheets of Marked Tabs	—
Marking Strip End Plug	GH60

Other Terminations

Table 6 - Types GA6, GP6, and GS6 (continued on next page)

Class 9080		TYPE GA6	TYPE GP6	TYPE GS6
				
		Flat Terminal Connectors	Pressure Wire Connectors	Slip-On Connectors
Maximum Voltage Rating		600	600	600
Maximum Amperage Rating ⁸	UL	40	40	20
	CSA	40	40	20
Wire Range		#22–#12 AWG	#18–#12 AWG	#22–#12 AWG
Maximum Wire Combination		Ring or Spade Connectors 1 or 2 - #12, 1 or 2 - #18 1 or 2 - #14, 1 or 2 - #20 1 or 2 - #16, 1 or 2 - #22	1 or 2 - #12 1 or 2 - #14 1 or 2 - #16 1 or 2 - #18	0.250 x 0.032 in. Slip-on Connectors 1 or 2 - #12, 1 or 2 - #18 1 or 2 - #14, 1 or 2 - #20 1 or 2 - #16, 1 or 2 - #22
Wire Type		Solid or Stranded Copper Wire	Solid or Stranded Copper Wire	Solid or Stranded Copper Wire
Density—Sections per foot		32	32	16
Approx. Dimensions: D x H x W		1.80 x 1.48 x 0.37 in. (46 x 38 x 10 mm)	1.80 x 1.48 x 0.37 in. (46 x 38 x 10 mm)	2.19 x 1.69 x 0.75 in. (56 x 43 x 19 mm)
Block Material		Nylon		
Busbar Material		Tin Plated Brass		
Screw Material		Steel with Zinc Plating and Chromate Film		N/A
Box Lug Material		N/A	N/A	N/A
Temperature Rating		-40 to 257° F (-40 to 125° C)	-40 to 257° F (-40 to 125° C)	-40 to 257° F (-40 to 125° C)
Flammability Rating		UL94V2	UL94V2	UL94V2
Recommended Tightening Torque		18–20 lbf-in (2.1–2.3 N•m)	18–20 lbf-in (2.1–2.3 N•m)	N/A
Listings	UL	File E60616, Guide XCFR2		
RoHS Compliant	CSA	File LR62144, Class 6228 01		
Fingersafe per DIN 57470		YES	NO	NO
Block:				
• Natural (White)		GA6	GP6	GS6
• Black		—	—	—
• Blue		—	—	—
• Green		—	—	—
• Grey		—	—	—
• Orange		—	—	—
• Red		—	—	—
• Yellow		—	—	—





8. These maximum current values assume the use of insulated copper conductors with 75° C temperature rating, and are calculated based on NEC Article 310, Table 310-16. In most cases this value is the maximum ampacity of that wire or combination of wires (as listed in the above table) which has the greatest current carrying capacity. The actual allowable current for a particular application is dependent upon the number, size, insulation class, and other characteristics of the wires used.

Class 9080	TYPE GA6	TYPE GP6	TYPE GS6
	 Flat Terminal Connectors	 Pressure Wire Connectors	 Slip-On Connectors
End Barrier	GP6B	GP6B	GF6B
Mounting Track: ⁹			
• DIN 3: 0.5 m long	MH320	MH320	MH320
• DIN 3: 1.0 m long	MH339	MH339	MH339
• DIN 3: 2.0 m long	MH379	MH379	MH379
• Standard: 3 ft long	GH136	GH136	GH136
• Snap-Off: 3 ft long	GH236	GH236	GH236
• High Rise: 3 ft long	GH336	GH336	GH336
End Clamps:			
• Screw-in	GH10	GH10	GH10
• Slip-in	GH11	GH11	GH11
• DIN 3 End Clamp	MHA10	MHA10	MHA10
Jumpers:			
• 2 pole	GH78	GH78	—
• 6 pole	GH79	GH79	—
Cover	—	—	—
Vinyl Marking Strip	GH220	GH220	—
Sheets of Blank Marking Tabs	—	—	GH200
Sheets of Marked Tabs	—	—	GH210
Marking Strip End Plug	GH60	GH60	—



9. For additional mounting track, see page 18.

Other Blocks

Table 7 - Types GA6, GP6, and GS6 (continued on next page)

Class 9080		TYPE GF6	TYPE GG6	TYPE GT6
		 Fuse Block	 Circuit Isolating Switch	 Transient Voltage Suppressor
Maximum Voltage Rating		600	600	600
Maximum Amperage Rating ¹⁰	UL	30	30	N/A
	CSA	30	30	N/A
Wire Range		#18–#10 AWG	#18–#10 AWG	#18–#10 AWG
Maximum Wire Combination		1 - #10, 1 to 4 - #16 1 - #12, 1 to 4 - #18 1 - #14	1 - #10, 1 to 4 - #16 1 - #12, 1 to 4 - #18 1 - #14	1 - #10, 1 to 4 - #16 1 - #12, 1 to 4 - #18 1 - #14
Wire Type		Solid or Stranded Copper Wire	Solid or Stranded Copper Wire	Solid or Stranded Copper Wire
Density—Sections per foot		16	16	24
Approx. Dimensions: D x H x W		2.19 x 2.33 x 0.75 in. (56 x 59 x 19 mm)	2.19 x 2.07 x 0.76 in. (56 x 53 x 19 mm)	2.16 x 2.55 x 0.50 in. (55 x 65 x 13 mm)
Block Material		Nylon		
Busbar Material		Tin Plated Copper		N/A
Screw Material		Steel with Zinc Plating and Chromate		
Box Lug Material		N/A	N/A	Copper
Temperature Rating		-40 to 221 ° F (-40 to 105° C)	-40 to 257° F (-40 to 125° C)	-40 to 257° F (-40 to 125° C)
Flammability Rating		UL94V2	UL94V2	UL94V2
Recommended Tightening Torque		18–20 lbf-in (2.1–2.3 N•m)	18–20 lbf-in (2.1–2.3 N•m)	18–20 lbf-in (2.1–2.3 N•m)
Listings		File E60616, Guide XCFR2		
RoHS Compliant		File LR62144, Class 6228 01		
Fingersafe per DIN 57470		YES	NO	NO
Block:				
• Natural (White)		GF6	GG6	GT6
• Black		—	—	—
• Blue		—	—	—
• Green		—	—	—
• Grey		—	—	—
• Orange		—	—	—
• Red		—	—	—
• Yellow		—	—	—

10. These maximum current values assume the use of insulated copper conductors with 75° C temperature rating, and are calculated based on NEC Article 310, Table 310-16. In most cases this value is the maximum ampacity of that wire or combination of wires (as listed in the above table) which has the greatest current carrying capacity. The actual allowable current for a particular application is dependent upon the number, size, insulation class and other characteristics of the wires used.

Class 9080	TYPE GF6	TYPE GG6	TYPE GT6
	 Fuse Block	 Circuit Isolating Switch	 Transient Voltage Suppressor
End Barrier	GF6B	GF6B	GT6B
Mounting Track: ¹¹			
• DIN 3: 0.5 m long	MH320	MH320	MH320
• DIN 3: 1.0 m long	MH339	MH339	MH339
• DIN 3: 2.0 m long	MH379	MH379	MH379
• Standard: 3 ft long	GH136	GH136	GH136
• Snap-Off: 3 ft long	GH236	GH236	GH236
• High Rise: 3 ft long	GH336	GH336	GH336
End Clamps:			
• Screw-in	GH10	GH10	GH10
• Slip-in	GH11	GH11	GH11
• DIN 3 End Clamp	MHA10	MHA10	MHA10
Blown Fuse Indicator: 120–240 V	GLP3	N/A	N/A
Blown Fuse Indicator: 277–600 V	GLP6	N/A	N/A
Replacement Fuse Puller	GH63	N/A	N/A
Vinyl Marking Strip	N/A	GH220	GH220
Sheets of Blank Marking Tabs	GH200	GH200	GH200
Sheets of Marked Tabs	GH210	GH210	GH210
Marking Strip End Plug	N/A	N/A	—

11. For additional mounting track, see page 18.

Custom Assemblies

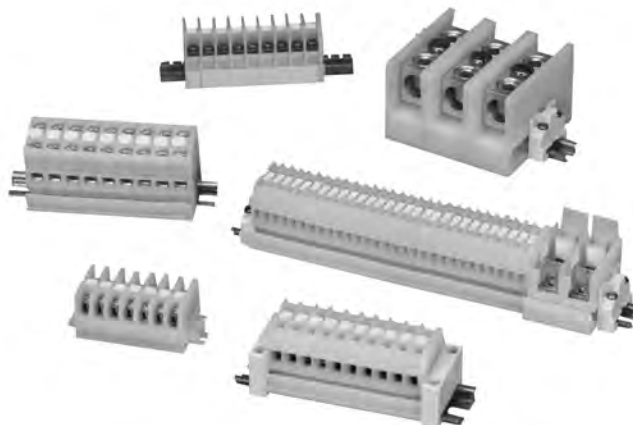

Order a custom assembly built as required for the application. Any style Class 9080 Type G terminal blocks on either a standard or a snap-off channel can be made to order. As standard, custom assemblies use 9080GH mounting track with screw-on end clamps. Some options include blank marking strip, pre-marked marking strip (1 to 25), and assemblies of mixed block styles. Other options are available. Consult the table below.

To order one terminal block type, add the required number of sections to the end of the catalog number of the terminal block. For example, to order an assembly of 25 9080GR6 terminal blocks, specify 9080GR625.

To order more than one terminal block type in an assembly, provide a detailed drawing of the desired assembly with your order.

NOTE: Unless otherwise indicated on the drawing, the order will be assembled to the next larger inch increment of standard track





Table 8 - Custom Assemblies

Options	Suffix	Example
Substitute slip-in end clamps	C	9080GR625C
Substitute snap-off channel	B	9080GR625BC ¹²
For direct mount assembly of 9080GK6 blocks	D	9080GK625D
Add a blank vinyl marking strip	M	9080GR625M
Add pre-marked (1–25 only) marking strip	MPO	9080GR625MPO
Mount on 35 mm DIN 3 track instead of 9080GH track	T	9080GR625T

To order, specify Class and Type. For example, Class 9080 Type GA612 = 9080GA612.

12. The 9080GH10 screw-on end clamp is not recommended for use with the snap-off channel. The 9080GH11 slip-in end clamp is recommended for use with the snap-off channel.

Mounting Track

Description		Length: m (in.)	Catalog Number
IEC Type Mounting Track			
DIN 3 Symmetrical rail 35 x 7.5 mm (1.38 in. x .295 in.) in compliance with EN 50022 standard (DIN 462777-3). Available in shorter length. Contact Schneider Electric.	Galvanized steel, no mounting holes 	0.5 m (19.68 in.)	9080 MH220
		1 m (39.37 in.)	9080 MH239
		2 m (78.74 in.)	9080 MH279
	Galvanized steel, prepunched 	0.5 m (19.68 in.)	9080 MH320
		1 m (39.37 in.)	9080 MH339
		2 m (78.74 in.)	9080 MH379
NEMA Type Mounting Track			
Standard Channel Made of galvanized steel. Supplied with prepunched holes to make installation easy. 	0.08 m (3 in.)	9080 GH103	
	0.10 m (4 in.)	9080 GH104	
	0.13 m (5 in.)	9080 GH105	
	0.15 m (6 in.)	9080 GH106	
	0.18 m (7 in.)	9080 GH107	
	0.20 m (8 in.)	9080 GH108	
	0.23 m (9 in.)	9080 GH109	
	0.25 m (10 in.)	9080 GH110	
	0.28 m (11 in.)	9080 GH111	
	0.30 m (12 in.)	9080 GH112	
	0.33 m (13 in.)	9080 GH113	
	0.36 m (14 in.)	9080 GH114	
	0.38 m (15 in.)	9080 GH115	
	0.41 m (16 in.)	9080 GH116	
	0.46 m (18 in.)	9080 GH118	
	0.91 m (36 in.)	9080 GH136	
	1.22 m (48 in.)	9080 GH148	
1.83 m (72 in.)	9080 GH172		
Snap-Off Channel Made of galvanized steel with serrated segments, spaced approximately 5/16 in. apart. Supplied with prepunched holes to make installation easy. 	0.91 m (36 in.)	9080 GH236	
	1.22 m (48 in.)	9080 GH248	
	1.83 m (72 in.)	9080 GH272	
High Rise Channel Made of extruded aluminum. 	0.91 m (36 in.)	9080 GH336	

Accessories

Table 9 - Jumpers and Fanning Strip







Description	Catalog Number	
Jumpers		
6-pole jumpers can be snapped off to provide 3, 4, or 5 pole jumpers. Material is CDA Alloy 110 Copper.		
	2 pole jumper for 9080 GM6	9080 GH700
	6 pole jumper for 9080 GM6	9080 GH710
	2 pole jumper for 9080 GK6, GR6	9080 GH72
	6 pole jumper for 9080 GK6, GR6	9080 GH73
	2 pole jumper for 9080 GC6	9080 GH74
	6 pole jumper for 9080 GC6	9080 GH75
	2 pole jumper for 9080 GD6	9080 GH76
	2 pole jumper for 9080 GA6, GP6	9080 GH78
	6 pole jumper for 9080 GA6, GP6	9080 GH79
Fanning Strip		
	Snap-together fanning strip section for 9080 GK6, GR6	9080 GH52

Table 10 - End Clamps





Description	Type
<p data-bbox="518 228 869 250">Screw-on End Clamp for DIN 3 Track</p>  <p data-bbox="518 407 1061 452">Made of polycarbonate. Screws are zinc plated steel with iridescent chromate film. Screws are shipped backed out.</p>	MHA10
<p data-bbox="518 474 869 497">Screw-on End Clamp for DIN 3 Track</p>  <p data-bbox="518 631 1061 676">Made of polycarbonate. Screws are zinc plated steel with iridescent chromate film.</p>	MH10
<p data-bbox="518 687 901 710">Screw-on End Clamp for 9080GH Track</p>  <p data-bbox="518 866 1061 911">Made of polycarbonate. Screws are zinc plated steel with iridescent chromate film. Screws are shipped backed out.</p>	<p data-bbox="1109 687 1220 710">9080 GH10</p> <p data-bbox="1109 721 1252 810">Not recommended with Snap-off channel.</p>
<p data-bbox="518 922 869 945">Slip-in End Clamp for 9080GH Track</p>  <p data-bbox="518 1102 1013 1124">Made of spring steel with an iridescent chromate film</p>	<p data-bbox="1109 922 1220 945">9080 GH11</p> <p data-bbox="1109 956 1284 1046">Not to be used with 9080 GE6 or 9080 GK6.</p>

Table 11 - Marking Accessories









Description		Catalog Number
	25 ft. blank vinyl marking strip	9080 GH220
 Vinyl Marking Strips numbered 1–25	For 9080 GK6, GR6	9080 GH21
	For 9080 GA6, GP6	9080 GH22
	For 9080 GM6	9080 GH230
 30 Adhesive Backed Strips, 11 in. Long	For 9080 GM6	9080 GH300
	For 9080 GA6, GK6, GP6, GR6	9080 GH31
	For 9080 GC6, GD6	9080 GH32
	Blank pin-feed marking tabs—6 x 20 (total 120) marking tabs for 9080 GR6, GD6, and GT6	9080 GH200
	Pre-marked 2 times 01 to 50 plus 20 various marking tabs (total 120 marking tabs) for 9080 GR6, GD6, and GT6	9080 GH210
	Marking strip end plug for 9080 GK6, GR6, GM6, GA6, GP6, GC6, GD6, GE6, GT6	9080 GH60
	Transition barrier between 9080 GK6 and all other G sections	9080 GH61
	Cover for 9080 GR6 and 9080 GR6T	9080 GH62
	Banana test plug for 9080 GR6T	9080 GH90
	Test plug adapter for 9080 GR6T (included as standard with 9080 GR6T)	9080 GH91

Table 12 - Miscellaneous Accessories

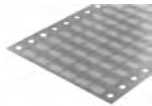
Description		Type
Angle Bracket Kit 	Includes 2 brackets and hardware for mounting track to the brackets.	9080 MH82

Single-Pole Thermal-Magnetic Control Circuit Protectors

Table 13 - Single-Pole Type GCB Circuit Protector Blocks

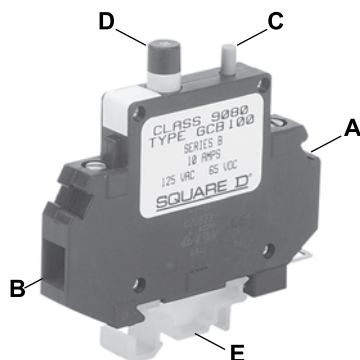

- A. Thermal-magnetic circuit protector
- B. 14 different current ratings: 0.1–15 A
- C. On-Off switch
- D. Visible trip indication
- E. Mounts on Class 9080 GH track and on DIN mounting track

9080GCB circuit protector blocks have solderless box lugs. They accept one CU 10–16 AWG wire.

Table 14 - Technical Data

Dielectric strength	1500 Vac
Insulation resistance	100 MΩ
Weight	Approximately 2.2 oz.
Terminals	Box lug type
Recommended tightening torque	8–10 lbf-in (0.9–1.1 N•m)
Approvals	UL File: E233026 CNN: QVN02 CE CSA File: 025490 Class: 3211–07
Fingersafe per DIN 57470	Yes
Maximum voltage rating	<ul style="list-style-type: none"> • GCB01 through GCB70 • GCB100 and GCB150
Maximum interrupting rating	200 A, but not exceeding 10,000% (100 times) rated current

Selection:

1. Determine the inrush correction factor from Table A below.
2. Determine the temperature correction factor from Table B below.
3. Determine the sealed current of the load that is being protected.
4. Multiply the sealed current by the two correction factors and choose the closest circuit protector.

NOTE: Choosing a circuit protector with a value lower than the calculated value might cause nuisance tripping, while choosing the larger might provide a protector that will not properly protect the load.

Example:

A solenoid with sealed current of 0.75 A, an inrush ratio of 1:6, and in an ambient temperature of 85 °F:

- $0.75 \times 1.5 \times 1.05 = 1.18$
- Choose the 1.2 A protector

The 9080GCB circuit protectors come standard with the track adapter for mounting on 9080GH track (replacement adapter is 9080GH64). Removal of this adapter permits mounting on 9080MH2●●, MH3●●, and AM1 track. See page 18 for a complete listing of available tracks.

Table 15 - Maximum Current Values

Maximum Current	Internal Resistance ¾	Maximum Voltage	Single Pole Type	
0.1	133	250 Vac / 65 Vdc	GCB01	
0.5	6.6		GCB05	
0.8	2.55		GCB08	
1.0	1.97		GCB10	
1.2	1.22		GCB12	
1.5	0.86		GCB15	
2.0	0.49		GCB20	
2.5	0.31		GCB25	
3.0	0.20		GCB30	
4.0	0.10		GCB40	
5.0	0.80		GCB50	
7.0	0.30		GCB70	
10.0	<0.02		125 Vac	GCB100
15.0	<0.02		65 Vdc	GCB150

These maximum current values assume the use of insulated copper conductors with 75°C temperature rating, and are calculated based on NEC Article 310, Table 310-16. In most cases this value is the maximum ampacity of that wire or combination of wires (as listed in the above table) which has the greatest current carrying capacity. The actual allowable current for a particular application is dependent upon the number, size, insulation class and other characteristics of the wires used.

Table 16 - Table A: Inrush Ratio Correction

Inrush Ratio	1:1 to 1:4	1:5	1:6	1:7	1:8
Factor	1.3	1.4	1.5	1.6	1.7

Table 17 - Table B: Ambient Temperature Correction

Ambient Temperature	70 °F (21.1 °C)	100 °F (37.8 °C)	120 °F (48.9 °C)	140 °F (60 °C)	160 °F (71.1 °C)	180 °F (82.2 °C)	200 °F (93.3 °C)
Factor	1.0	1.1	1.2	1.3	1.4	1.5	1.6

Tripping Time

Tripping time of the circuit protector is determined from Table C below. Divide the circuit protector value by the temperature correction factor from Table B above to determine the actual rated current referenced in Table C.

Table 18 - Table C: Tripping Time in Seconds at 70 °F (21.1 °C)

Percent rated current	100%	200%	300%	400%	500%	600%	1000%	2000% and greater
Tripping Time (seconds)	no trip	10–40	38	1.5–9	0.8–6	0.003–4	0.003–2	Max. 0.02

NOTE: When several protectors are channel mounted adjacent to each other, the “no trip” current will be 80% of rated current at 70 °F.

Approximate Dimensions

Type G Block

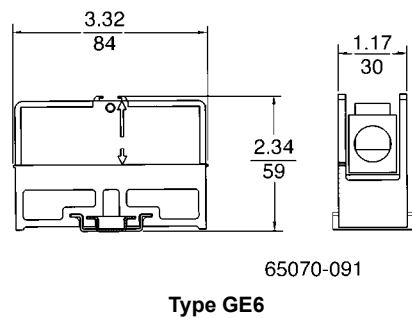
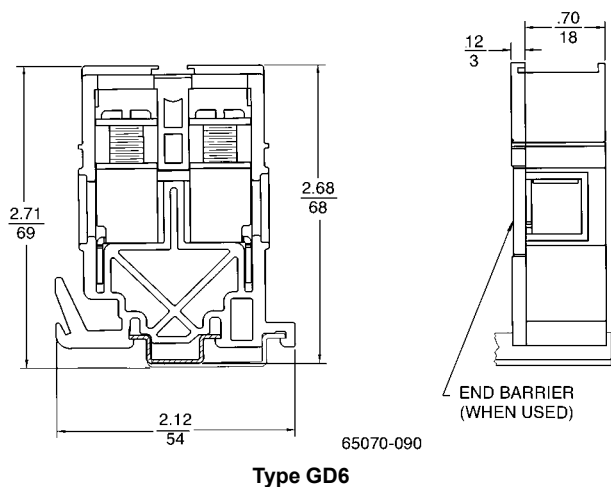
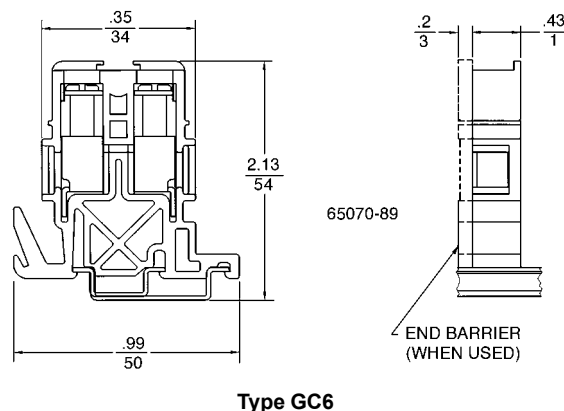
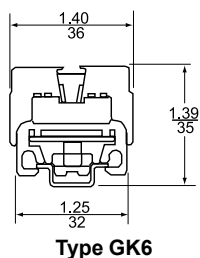
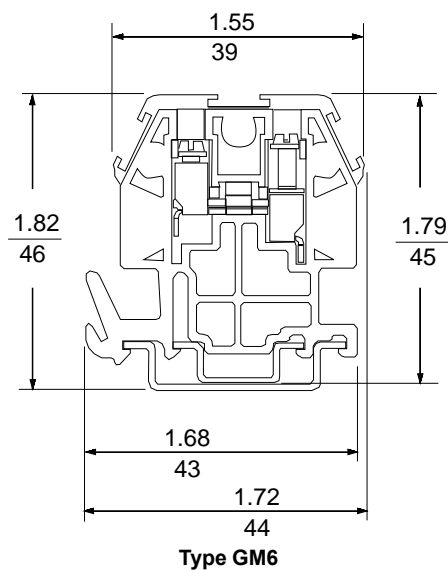
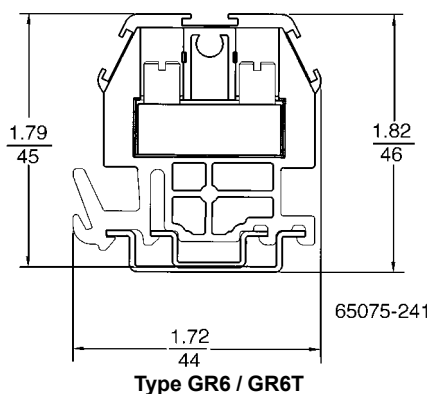

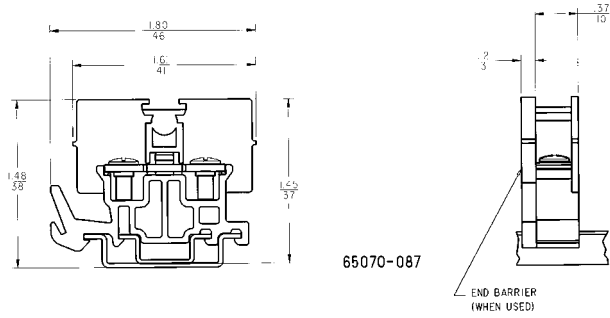

Type GA6

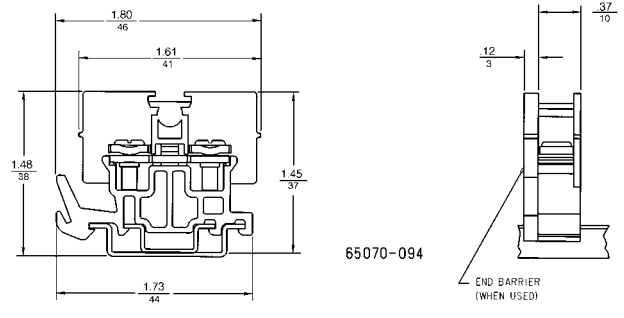

Type GP6

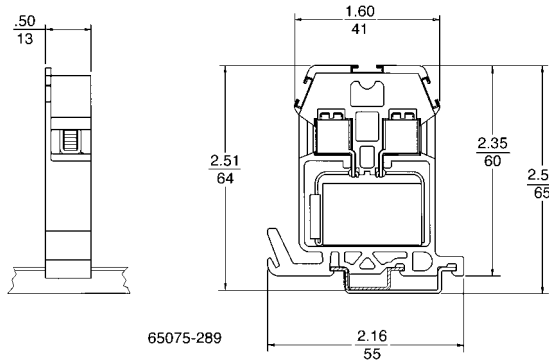

Type GT6

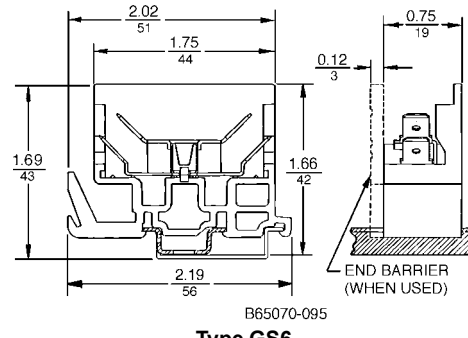

Type GS6

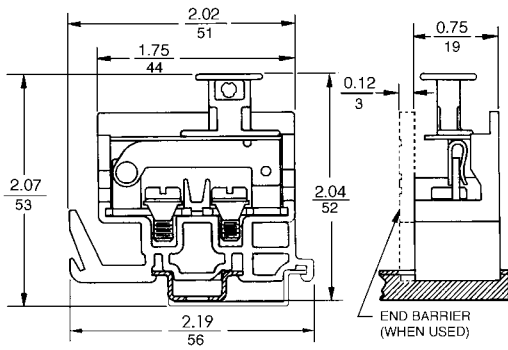

Type GG6

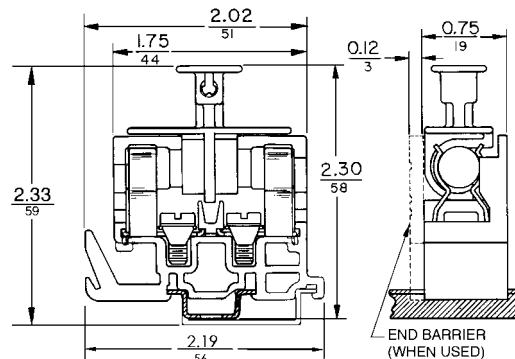

Type GF6 with Fuse Puller

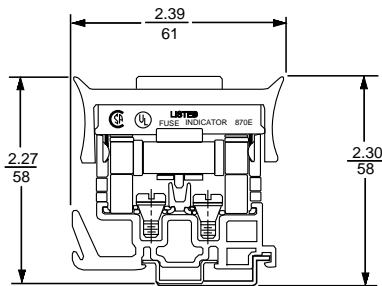

Type GF6 with Blown Fuse Indicator

Circuit Protectors and Assemblies

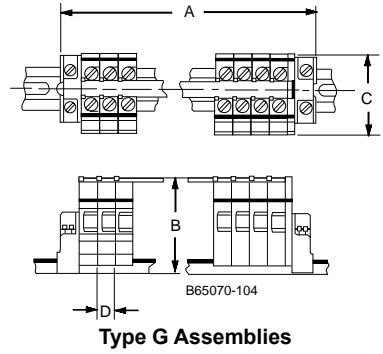
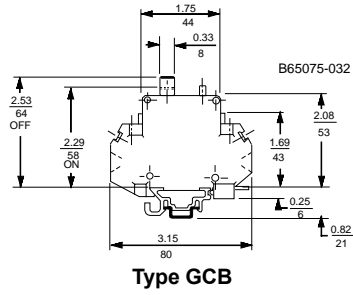
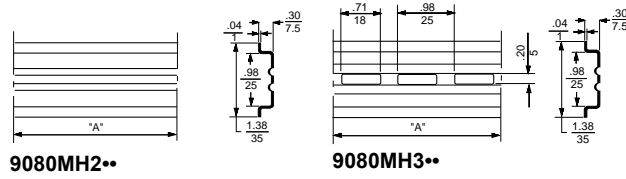

Table 19 - Dimensions

CLASS 9080 TYPE	Dim. A ¹³ in. (mm)	Dim. B 14in. (mm)	Dim. C in. (mm)	Dim. D in. (mm)	Blocks per foot
GA6	0.37 N + 0.93 (9.4 N + 23.6)	1.48 (37.6)	1.80 (45.7)	0.37 (9.4)	32
GC6	0.43 N + 0.93 (10.9 N + 23.6)	2.13 (54.1)	1.99 (50.5)	0.43 (10.9)	28
GD6	0.70 N + 0.93 (17.8 N + 23.6)	2.71 (68.8)	2.12 (53.8)	0.70 (17.8)	17
GE6	1.17 N + 0.93 (29.7 N + 23.6)	2.34 (59.4)	3.32 (84.3)	1.17 (29.7)	10
GF6 (with extractor)	0.75 N + 0.93 (19.1 N + 23.6)	2.33 (59.2)	2.19 (55.6)	0.75 (19.1)	16
GF6 (with blown fuse indicator)	0.75 N + 0.80 (19.1 N + 23.6)	2.39 (60.7)	2.30 (58.4)	0.75 (19.1)	16
GG6	0.75 N + 0.93 (19.1 N + 23.6)	2.07 (52.6)	2.19 (55.6)	0.75 (19.1)	16
GK6	0.35 N + 0.93 (8.9 N + 23.6)	1.39 (35.3)	1.40 (35.6)	0.35 (8.9)	34
GM6	0.24 N + 0.93 (6.0 N + 23.6)	1.82 (46.2)	1.72 (43.7)	0.24 (6.0)	51
GP6	0.37 N + 0.93 (9.5 N + 23.6)	1.48 (37.6)	1.80 (45.7)	0.37 (9.5)	32
GR6	0.35 N + 0.93 (8.9 N + 23.6)	1.82 (46.2)	1.72 (43.7)	0.35 (8.9)	34
GS6	0.75 N + 0.93 (19.1 N + 23.6)	1.69 (42.9)	2.19 (55.6)	0.75 (19.1)	16
GT6	0.50 N + 0.93 (12.7 N + 23.6)	2.55 (64.8)	2.16 (54.9)	0.50 (12.7)	24
GCB	0.50 N + 0.93 (12.7 N + 23.6)	3.38 (85.9)	3.15 (80.0)	0.50 (12.7)	24

13. Where N is the total number of blocks in the assembly. If slip-in end clamps (9080GH11) are used, subtract 0.8 inches (20.3 mm). Slip-in clamps cannot be used with 9080GK6, GE6 blocks.
 14. Dimension shown assumes use of DIN 3 track, except for the 9080 GK6 block.

Mounting Track and End Clamps



9080MH2

9080MH3

- If the last two digits of the catalog number is 20, then “A” is equal to 19.7 in.
- If the last two digits of the catalog number is 39, then “A” is equal to 39.4 in.
- If the last two digits of the catalog number is 79, then “A” is equal to 78.7 in.

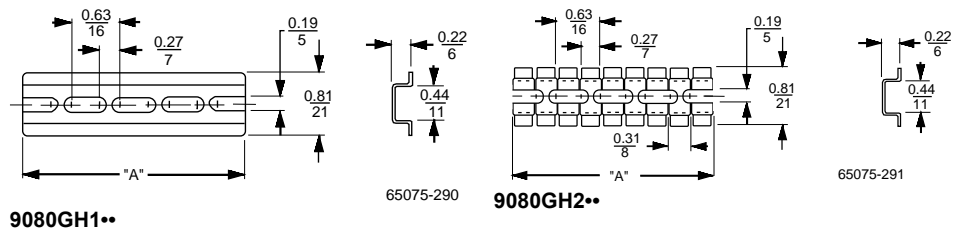

9080GH1

65075-290

9080GH2

65075-291

“A” is the last two digits of the catalog number in inches. For example, for 9080GH148, “A” is equal to 48 inches.

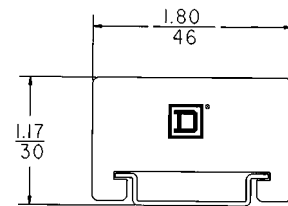

9080MHA10

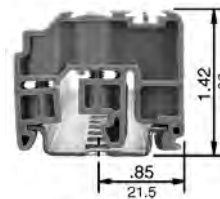

9080MH10 on 9080MH2 or 9080MH3 Track



9080MH10 on 9080MH1 Track

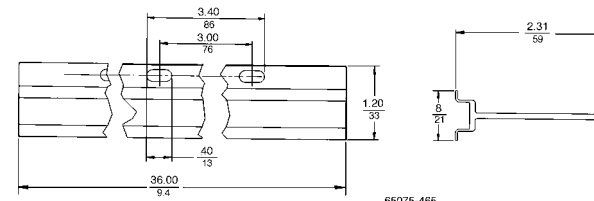

9080GH336

65075-465

Schneider Electric
800 Federal Street
Andover, MA 01810
USA

888-778-2733

www.schneider-electric.com

As standards, specifications, and design change from time to time,
please ask for confirmation of the information given in this publication.

© 1993 – 2018 Schneider Electric. All rights reserved.

9080CT9601R11/17